



Italian Society of Chemistry
Division of Organic Chemistry
Division of Medicinal Chemistry
Division of Mass Spectrometry

TARGETS IN HETEROCYCLIC SYSTEMS

Chemistry and Properties

Volume 12 (2008)

Reviews and Accounts on Heterocyclic Chemistry
http://www.soc.chim.it/it/libriecollane/target_hs

Editors

Prof. Orazio A. Attanasi

*Institute of Organic Chemistry, University of Urbino
Urbino, Italy*

and

Prof. Domenico Spinelli

*Department of Organic Chemistry, University of Bologna
Bologna, Italy*

Published by:

Società Chimica Italiana

Viale Liegi, 48

00198 Roma

Italy

Copyright © 2006 Società Chimica Italiana

All rights reserved. No part of this publication may be reproduced, stored in a retrieval system or transmitted in any form or by any means (electronic, electrostatic, magnetic tape, mechanical, photocopying, recording or otherwise) without permission in writing from the publishers. A person may photocopy an article for personal use.

Volume 1 (1997)	First edition 1997	ISBN 88-86208-24-3	
	Second edition 1999	ISBN 88-86208-24-3	
Volume 2 (1998)	First edition 1999	ISBN 88-86208-11-1	
Volume 3 (1999)	First edition 2000	ISBN 88-86208-13-8	
Volume 4 (2000)	First edition 2001	ISBN 88-86208-16-2	
Volume 5 (2001)	First edition 2002	ISBN 88-86208-19-7	
Volume 6 (2002)	First edition 2003	ISBN 88-86208-23-5	
Volume 7 (2003)	First edition 2004	ISBN 88-86208-28-6	ISSN 1724-9449
Volume 8 (2004)	First edition 2005	ISBN 88 86208-29-4	ISSN 1724-9449
Volume 9 (2005)	First edition 2006	ISBN 88 86208-31-6	ISSN 1724-9449
Volume 10 (2006)	First edition 2007	ISBN 978-88-86208-51-2	ISSN 1724-9449
Volume 11 (2007)	First edition 2008	ISBN 978-88-86208-52-9	ISSN 1724-9449
Volume 12 (2008)	First edition 2008	ISBN 978-88-86208-56-7	ISSN 1724-9449

Printed and bound in Italy by:

Arti Grafiche Editoriali s.r.l.

Via S. Donato, 148/C

61029 Urbino (Pesaro-Urbino)

Italy

May 2009

Editorial Advisory Board Members

Prof. Enrico Aiello

*University of Palermo
Palermo, Italy*

Prof. Jan Bergman

*Karolinska Institute
Huddinge, Sweden*

Prof. Robert K. Boeckman Jr.

*University of Rochester
Rochester, USA*

Prof. José A. S. Cavaleiro

*University of Aveiro
Aveiro, Portugal*

Prof. Leopoldo Ceraulo

*University of Palermo
Palermo, Italy*

Prof. Janine Cossy

*ESPCI
Paris, France*

Dr. Daniele Donati

*Glaxo Wellcome
Verona, Italy*

Prof. José Elguero

*CSIC
Madrid, Spain*

Prof. Dieter Enders

*RWTH
Aachen, Germany*

Prof. Leon Ghosez

*Catholic University of Louvain
Louvain la Neuve, Belgium*

Prof. Gianluca Giorgi

*University of Siena
Siena, Italy*

Prof. Lucedio Greci

*University of Ancona
Ancona, Italy*

Prof. Laurence M. Harwood

*University of Reading
Reading, UK*

Prof. Victor G. Kartsev

*InterBioScreen Ltd
Moscow, Russia*

Prof. Steven V. Ley

*University of Cambridge
Cambridge, UK*

Prof. Alexander McKillop

*University of East Anglia
Norwich, England*

Prof. Giovanni Sindona

*University of Calabria
Arcavacata di Rende, Italy*

Prof. Branko Stanovnik

*University of Ljubljana
Ljubljana, Slovenia*

Prof. Richard J. K. Taylor

*University of York
York, UK*

Prof. Eric J. Thomas

*University of Manchester
Manchester, UK*

Indexed/Abstracted in: Chemical Abstracts; Current Contents; ISI/ISTP&B online database; Index to Scientific Book Contents; Chemistry Citation Index; Current Book Contents; Physical, Chemical & Earth Sciences; Methods in Organic Synthesis; The Journal of Organic Chemistry; La Chimica e l'Industria; Synthesis.

Preface

Heterocyclic derivatives are important in organic chemistry as products (including natural) and/or useful tools in the construction of more complicated molecular entities. Their utilization in polymeric, medicinal and agricultural chemistry is widely documented. Both dyestuff structures and life molecules frequently involve heterocyclic rings that play an important role in several biochemical processes.

Volume 12 (2008) keeps the international standard of THS series and contains fifteen chapters, covering the synthesis, reactivity, activity (including medicinal) and mass spectrometry of different heterorings. Authors from France, Germany, Italy, Norway, Portugal, Slovakia, Spain, The Netherlands and USA are present in this book.

Comprehensive Reviews reporting the overall state of the art on wide fields as well as personal Accounts highlighting significant advances by research groups dealing with their specific themes have been solicited from leading Authors. The submission of articles having the above-mentioned aims and concerning highly specialistic topics is strongly urged. The publication of Chapters in THS is free of charge. Firstly a brief layout of the contribution proposed, and then the subsequent manuscript, may be forwarded either to a Member of the Editorial Board or to one of the Editors.

The Authors, who contributed most competently to the realization of this Volume, and the Referees, who cooperated unselfishly (often with great patience) spending valuable attention and time in the review of the manuscripts, are gratefully acknowledged.

The Editors thank very much Dr. Lucia De Crescentini for her precious help in the editorial revision of the book.

Orazio A. Attanasi and Domenico Spinelli

Editors

Table of Contents

(for the contents of Volumes 1–11 please visit: <http://www.soc.chim.it>)

Synthetic accessibility to protoporphyrin-IX, chlorophyll *a* and (2*R*)-phytychromobilin and other biologically important pyrrole derivatives in any ¹³C and ¹⁵N enriched isotopic form

1

Prativa B. S. Dawadi and Johan Lugtenburg

1. Introduction

2. Synthesis and discussion

2.1. Isotopically labeled pyrroles, protoporphyrins and related derivatives

- 2.1.1. [1-¹⁵N]-3-Cyano-4-methyl-1*H*-pyrrole
- 2.1.2. Benzyl 3-(2-methoxycarbonylethyl)-4-methoxycarbonylmethyl-5-methyl [2-¹³C]-pyrrole-2-carboxylate, benzyl 3-(2-methoxycarbonylethyl)-4-methoxycarbonylmethyl[2-¹³C]-pyrrole-2-carboxylate, benzyl 5-([¹³C]-formyl)-3-(2-methoxycarbonyl-ethyl)-4-methoxy-carbonylmethyl[2-¹³C]-pyrrole-2-carboxylate and 2-([¹³C]-formyl)-4-(2-methoxy-carbonylethyl)-3-methoxycarbonylmethyl[5-¹³C]-pyrrole
- 2.1.3. Ethyl 3,5-dimethyl-4-ethyl[1-¹⁵N]-pyrrole-2-carboxylate and ethyl 3,5-dimethyl-4-ethyl[3-¹³C]-pyrrole-2-carboxylate
- 2.1.4. [11-¹³C]-Porphobilinogen
- 2.1.5. Dibenzyl 3,5-dimethyl[2,3,4,5-¹³C₄]-pyrrole-2,5-dicarboxylate
- 2.1.6. 5-Substituted 2-pyrrole esters
- 2.1.7. 3-Cyanopyrrole, 3-cyano-4-methylpyrrole, pyrrole-3-carboxylate and 4-methylpyrrole-carboxylate
- 2.1.8. [2-¹³C]-3-Cyano-4-methyl-3-pyrrolin-2-one and [3-¹³C]-3-cyano-4-methyl-3-pyrrolin-2-one
- 2.1.9. 3,4-Disubstituted pyrrolinones and 3-(**pentadeuteroethyl**)-4-methylpyrrolin-2-one
- 2.1.10. Chlorophyll *a*
- 2.1.11. Protoporphyrin-IX, hemin and biliverdin
- 2.1.12. (2*R*)-Phytychromobilin and (2*R/S*)-phytycyanobilin
 - 2.1.12.1. The synthesis of pyrromethenone **124** (A,B-ring segment of phytychromobilin)
 - 2.1.12.2. The synthesis of pyrromethenone **132** (C,D-ring segment of phytychromobilin)
 - 2.1.12.3. Coupling of pyrromethenones **124** and **132** to form (2*R*)-phytychromobilin
- 2.1.13. Bilirubin and its analogs

3. Conclusion

Acknowledgments

References

Laurence Feray and Michèle P. Bertrand

1. Introduction
2. Radical cyclizations
 - 2.1. Intramolecular addition of alkoxy-carbonyl radicals to conjugated alkyne
 - 2.2. Enyne cyclization
 - 2.2.1. Tandem addition of nucleophilic radicals to activated triple bond/5-exo ring closure
 - 2.2.2. Tandem addition of electrophilic radicals to double bond/5-exo ring closure onto conjugated alkyne
 - 2.3. Iodine atom transfer-mediated cyclization onto conjugated alkyne
 - 2.4. Two-step strategies involving 5-exo-dig cyclizations followed by oxidation of resulting 3-alkylidene-tetrahydrofurans
3. Transition metal-mediated cyclizations
 - 3.1. Cyclization of alkoxy-carbonyl- and carbamoyl- metal complexes onto triple bond
 - 3.2. Enyne cyclization
 - 3.2.1. Palladium-catalyzed reactions
 - 3.2.1.1. Halopalladation
 - 3.2.1.2. Acetoxypalladation
 - 3.2.1.3. Carbopalladation
 - 3.2.1.4. Tandem cyclization/Suzuki coupling
 - 3.2.2. Rhodium(I)-catalyzed reactions
 - 3.2.2.1. Cycloisomerization of 1,6-enynes
 - 3.2.2.2. Reductive cycloisomerization of 1,6-enynes and acetylenic aldehydes
 - 3.2.3. Alkenylative cyclization promoted by ruthenium catalysts
 - 3.3. Two-step procedures involving Pd(0)-mediated cyclization followed by oxidation
 - 3.4. Miscellaneous methodologies
 - 3.4.1. Cycloalkenylation of tungsten-alkynyl amines
 - 3.4.2. Cyclization involving Pd(0) as the leaving group
 - 3.4.2.1. Pd-catalyzed heteroannulation of 1,3-dienes
 - 3.4.2.2. Pd-catalyzed carbonylation of 3-iodohomoallylic alcohols
 - 3.4.3. Ti(II)-mediated cyclization of homopropargylic carbonates
 - 3.4.4. [2+2+1] Cycloaddition leading to bicyclic α -alkylidene- γ -lactones and lactams
4. Conclusion

The reaction of carbonyl compounds and nitriles with triflic anhydride.

Synthesis of pyrimidines, benzothiazines, oxazoles and triazines

Roberto Martínez-Álvarez and Antonio Herrera

1. Introduction
 - 1.1. Triflic anhydride and vinyl triflates

2. Initial investigations
 - 2.1. The reaction of vinyl triflates and nitriles. Mechanism of the reaction
 3. Synthesis of substituted pyrimidines
 - 3.1. The reaction of aldehydes and ketones in the presence of triflic anhydride
 - 3.2. Regioselectivity in the reaction of aliphatic ketones
 - 3.3. Synthesis of halo- and alkoxy pyrimidines
 - 3.4. Synthesis of substituted benzoquinazolines and related compounds
 - 3.5. Cyclobutapyrimidines and pyrimidine *ortho*-quinodimethanes in the Diels-Alder reaction
 - 3.6. The special reactivity of benzyl cyanides
 - 3.7. The use of methyl thiocyanate. Synthesis of functionalized pyrimidines
 - 3.8. Synthesis of heterocycles fused pyrimidines
 4. The reaction with carbonyl compounds containing sulfur atoms
 - 4.1. The reaction of thioesters with nitriles and triflic anhydride
 - 4.2. Stereoselective synthesis of substituted 1,3-benzothiazines
 - 4.3. Synthesis of 1,3-oxazoles
 5. Synthesis of 2,4,6-trisubstituted 1,3,5-triazines
 6. Conclusions
- Acknowledgments
- References

Metal-mediated C–C and C–N bond formation in the synthesis of bioactive purines

85

Lise-Lotte Gundersen

1. Introduction
2. C-C Bond formation
 - 2.1. Addition of organometallic reagents followed by rearomatization
 - 2.1.1. Addition of organolithium reagents
 - 2.1.2. Addition of organomagnesium reagents
 - 2.2. Cross-coupling of halopurines
 - 2.2.1. Coupling with organolithium reagents
 - 2.2.2. Coupling with organocuprates-copper-mediated couplings
 - 2.2.3. Coupling with organomagnesium reagents
 - 2.2.4. Coupling with organotin reagents (Stille coupling)
 - 2.2.5. Coupling with organozinc reagents (Negishi coupling)
 - 2.2.6. Coupling with organoboron reagents (Suzuki-Miyaura coupling)
 - 2.2.7. Coupling with organoaluminium reagents
 - 2.2.8. Heck coupling
 - 2.2.9. Sonogashira coupling
 - 2.2.10. Direct CH alkylation and arylation
 - 2.2.11. Regioselectivity in cross coupling reactions of dihalopurines
 - 2.2.12. Further transformation of coupling products

- 2.3. C-C Bond formation *via* metallated purines
 - 2.3.1. Generation and reactivity of lithiated purines
 - 2.3.2. Generation and reactivity of stannylated purines
 - 2.3.3. Generation and reactivity of zincated purines
 - 2.3.4. Generation and reactivity of magnesiated purines
 - 2.3.5. Generation and reactivity of palladated purines
- 3. C-N Bond formation
 - 3.1. Buchwald-Hartwig coupling
 - 3.1.1. Buchwald-Hartwig reaction on halopurines
 - 3.1.2. Buchwald-Hartwig reaction on aminopurines
 - 3.2. Cu-mediated *N*-arylation
 - 3.3. Palladium(0)-mediated *N*-allylation
- 4. Biological activities
 - 4.1. Cytotoxic purines
 - 4.2. Antimicrobial purines
 - 4.3. Antiviral purines
 - 4.4. Adenosine receptor ligands
 - 4.5. Cytokinin analogs
 - 4.6. Inhibitors of 15-lipoxygenase
- 5. Conclusions
- Acknowledgments
- References
- Abbreviations

Indole phytoalexins from brassicaceae: synthesis and anticancer activity

120

Peter Kutschy and Roman Mezencev

- 1. Introduction
- 2. Structure and synthesis
 - 2.1. Phytoalexins with sulfur-containing side chain or substituent at indole nucleus
 - 2.2. Phytoalexins with a side chain or substituent at indole nucleus not containing sulfur
 - 2.3. 3-(Thiazole-2-yl)indole derived phytoalexins
 - 2.4. 2,3-Fused indole phytoalexins
 - 2.5. Spiroindoline[3,5']- and spiroindoline[2,5']dihydrothiazole type phytoalexins
- 3. Anticancer activity
 - 3.1. Cytostatic and cytotoxic effects
 - 3.2. Cancer chemopreventive activity
 - 3.3. Modulation of immune response
- 4. Conclusions
- Acknowledgment
- References

1. Introduction
2. General strategies for the synthesis of phosphepines
 - 2.1. Cyclization of a single component
 - 2.1.1. Thermal cyclization of arenylphosphonic acid
 - 2.1.2. Electrophilic cyclization
 - 2.1.3. Reductive coupling *via* McMurry reaction
 - 2.1.4. *Via* ring-closing metathesis
 - 2.2. Ring formation by cyclization of two components
 - 2.2.1. *Via* reaction of 1,6-dilithium salts with dichlorophosphines
 - 2.2.2. *Via* reaction of silylphosphines with acyl chloride
 - 2.2.3. *Via* radical cyclization reactions of silylphosphines with alkenes
 - 2.2.4. Nucleophilic addition reaction between 1,5-hexadiene and phosphine
 - 2.3. Ring-expansion
 - 2.3.1. From phospholes and dihydrophospholes
 - 2.3.2. From phosphinine derivatives *via* ring enlargement by a carbene unit
 - 2.4. Synthesis and modification of chiral dinaphthosphepines
 - 2.4.1. Monodentate phosphepines
 - 2.4.2. Bidentate phosphepines
3. Asymmetric catalysis with phosphepines
 - 3.1. Asymmetric catalysis with transition metal complexes
 - 3.1.1. Asymmetric hydrogenation
 - 3.1.1.1. Monodentate phosphepines
 - 3.1.1.2. Bidentate phosphepines
 - 3.1.1.3. Asymmetric hydrogenation with self-assembling phosphepine catalyst
 - 3.1.2. Rh-catalyzed asymmetric hydroformylation
 - 3.1.3. Pd-catalyzed asymmetric allylic alkylation and amination (Tsuji-Trost reaction)
 - 3.1.3.1. Pd-catalyzed asymmetric allylic alkylation
 - 3.1.3.2. Pd-catalyzed asymmetric allylic amination
 - 3.1.4. Enantioselective catalytic allylation of carbonyl groups by umpolung of π -allyl palladium complexes
 - 3.1.5. Pd-mediated Suzuki-Miyaura coupling
 - 3.1.6. Asymmetric hydroboration
 - 3.1.7. Rh-catalyzed 1,4-additions of arylboronic acids to enones
 - 3.1.8. Pt-catalyzed alkoxy- and hydroxycyclization of enynes
 - 3.2. Organocatalysis
 - 3.2.1. Asymmetric acylations and benzoylations
 - 3.2.2. Asymmetric [3+2] cycloadditions of imines with allenes
 - 3.2.3. Asymmetric [4+2] cycloadditions of imines with allenes

Cyclic phospho di- and triester as structural elements of nucleic acids

185

Christelle Dupouy, Corinne Payrastré and Jean-Marc Escudier

1. Introduction
 - 1.1. Nucleotides conformation
 - 1.2. Nucleic acids primary and secondary structures
 - 1.3. Modified nucleic acids
2. Macrocyclic phosphate esters
 - 2.1. *U*-Turn model
 - 2.2. 5'-Cyclouridylic acid and derivatives
 - 2.3. Synthesis of cyclic di- and trinucleotide by Ring Closure Metathesis (RCM)
3. Dioxaphosphorinane-Constrained Nucleic Acid
 - 3.1. Diastereoselective synthesis of α,β -D-CNA
 - 3.2. Synthesis of α,β,γ -D-CNA and δ,ϵ,ζ -D-CNA
 - 3.3. Nucleosidic and sugar based approach towards ϵ,ζ -D-CNA
 - 3.4. Structural assignment
 - 3.5. Preliminary results on DNA duplex stabilization
4. Conclusions

Acknowledgments

References

Chemistry of biologically active β -carbolines

212

Marta Rosillo, Alvaro González-Gómez, Gema Domínguez and Javier Pérez-Castells

1. Introduction
 - 1.1. Naturally occurring β -carbolines
 - 1.2. Biological activity of β -carbolines
2. Synthesis of β -carbolines
 - 2.1. The Pictet-Spengler reaction for the construction of the pyridine ring
 - 2.1.1. Catalytic PS reaction
 - 2.1.2. Solid-phase supported PS
 - 2.1.3. Pictet-Spengler combined with other processes
 - 2.2. The Bischler-Napieralski reaction
 - 2.3. Organometallic based methods
 - 2.4. Construction of the pyrrole ring
 - 2.5. Cycloaddition methodologies
 - 2.6. Other strategies
3. Transformations of β -carbolines
 - 3.1. Oxidations
 - 3.2. Reductions

- 3.3. Stereoselective alkylations
- 3.4. Metathesis
- 3.5. Reactions with activated alkynes
- 3.6. β -Carbolines as chiral ligands
- 4. Total syntheses of natural alkaloids containing the β -carboline system
- 5. Conclusions
- Acknowledgments
- References

Meso-substituted porphyrin synthesis from monopyrrole: an overview

258

Mariette M. Pereira, Carlos J. P. Monteiro and Andreia F. Peixoto

- 1. Introduction
- 2. *Meso*-substituted porphyrin synthesis
 - 2.1. One-pot synthesis
 - 2.2. Two-step synthesis
- 3. *Meso*-tetraarylporphyrin synthesis using sustainable chemistry approach
 - 3.1. Solvent-free reactions
 - 3.2. Microwave synthesis
 - 3.3. Ionic liquids
 - 3.4. Heterogeneous catalysis: zeolites and clays

Acknowledgments

References

Abbreviations

1,2- And 1,3-oxazolopyridines: versatile building blocks for the heterocyclic synthesis

279

Gianluca Giorgi and Fabio Ponticelli

- 1. Introduction
 - 1.1. Availability
 - 1.1.1. Oxazolopyridines
 - 1.1.2. Isoxazolopyridines
- 2. Structural characterization
 - 2.1. Nuclear Magnetic Resonance
 - 2.2. X-Ray crystallography
 - 2.3. Mass spectrometry
- 3. Chemical properties
 - 3.1. General aspects
 - 3.2. Oxazolopyridines reactivity
 - 3.3. Isoxazolopyridine reactivity
 - 3.3.1. Thermal reactivity
 - 3.3.2. Photochemical reactions

4. Conclusions
Acknowledgments
References

**New methods for the asymmetric synthesis of piperidines and pyrrolidines:
Chiral auxiliaries and asymmetric organocatalysis**

302

Jose L. Vicario, Dolores Badía, Luisa Carrillo, Nerea Ruiz and Efraim Reyes

1. Introduction
 2. Asymmetric synthesis of piperidine alkaloids using (*S,S*)-(+)-pseudoephedrine as chiral auxiliary
 - 2.1. A general and stereodivergent method for the asymmetric synthesis of 2-alkylpiperidine alkaloids
 - 2.2. Asymmetric synthesis of (–)-*β*-conhydrine
 3. Organocatalytic asymmetric synthesis of pyrrolidines
 - 3.1. Organocatalytic enantioselective [3+2] cycloaddition of azomethine ylides and α,β -unsaturated aldehydes
 - 3.2. Organocatalytic Michael reaction of aldehydes and nitroacrolein dimethylacetal. Synthesis of 3,4-disubstituted and 2,3,4-trisubstituted pyrrolidines
 4. Concluding remarks
- Acknowledgments
References

Synthesis of phosphorus-substituted sulfur heterocycles

328

Mihaela Gulea and Annie-Claude Gaumont

1. Introduction
2. Syntheses by phosphorylation of a sulfur heterocycle
 - 2.1. Syntheses using phosphorus nucleophiles
 - 2.1.1. Arbuzov-type reactions
 - 2.1.2. Metal-catalyzed P–C coupling reactions
 - 2.1.3. Nucleophilic additions of di- or trialkylphosphites
 - 2.1.4. Pummerer-type reactions
 - 2.2. Syntheses using phosphorus electrophiles
3. Syntheses involving the formation of the sulfur heterocycle
 - 3.1. Cycloaddition reactions
 - 3.1.1. [4+2] Cycloadditions
 - 3.1.1.1. With phosphorylated thiocarbonyl compounds as dienophiles
 - 3.1.1.1.1. Phosphinoyl thioaldehydes
 - 3.1.1.1.2. Phosphonodithioformates
 - 3.1.1.1.3. Phosphoryl-substituted sulfines
 - 3.1.1.2. With phosphorylated thiocarbonyl compounds as dienes

- 3.1.2. [3+2] Cycloadditions
- 3.2. Syntheses based on intramolecular cyclizations
 - 3.2.1. Carbanion mediated cyclizations
 - 3.2.2. Carbenoid mediated cyclizations
 - 3.2.3. Radical mediated cyclizations
 - 3.2.4. Electrocyclizations
 - 3.2.4.1. 1,3-Dipolar electrocyclizations
 - 3.2.4.2. Domino Knœvenagel/1,6-heteroelectrocyclizations
- 3.3. Miscellaneous
 - 3.3.1. Sigmatropic rearrangements
 - 3.3.1.1. [2,3]-Sigmatropic rearrangement
 - 3.3.1.2. [1,3]-Sigmatropic rearrangement
 - 3.3.2. Ring-closing metathesis
- 4. Conclusion
- Acknowledgments
- References

Carbolithiation reactions in the synthesis of heterocycles

349

Roberto Sanz and Alberto Martínez

- 1. Introduction
- 2. Intermolecular reactions
 - 2.1. General aspects of intermolecular carbolithiation reactions
 - 2.2. Synthesis of indole derivatives
 - 2.3. Synthesis of quinoline derivatives
 - 2.4. Synthesis of other heterocyclic systems
- 3. Intramolecular reactions
 - 3.1. Special features of intramolecular carbolithiation reactions
 - 3.1.1. Stereoselectivity and mechanism
 - 3.1.2. Scope and limitations
 - 3.2. Synthesis of furan derivatives
 - 3.3. Synthesis of benzofuran derivatives
 - 3.4. Synthesis of pyrrole derivatives
 - 3.5. Synthesis of azabicyclo derivatives
 - 3.6. Synthesis of indole derivatives
 - 3.7. Synthesis of other heterocyclic systems
 - 3.8. Synthesis of heterocycles through carbolithiation of arynes
- 4. Conclusions
- Acknowledgments
- References

Oligo- and poly(2,5-thienylene-ethynylene)s

390

Herbert Meier

1. Introduction
 2. Synthetic approach
 - 2.1. Monodisperse oligomers
 - 2.2. Multidisperse polymers
 3. Molecular structures
 4. Electronic absorption and fluorescence
 5. Applications in materials science
 6. Conclusion and outlook
- References and notes

Chemoenzymatic synthesis of optically active pyridine derivatives

414

Vicente Gotor-Fernández, Eduardo Busto and Vicente Gotor

1. Introduction
 2. Use of hydrolases
 - 2.1. Lipase-catalyzed kinetic and dynamic kinetic resolution of alcohols or esters
 - 2.2. Proteases in the resolution of esters through hydrolytic processes
 - 2.3. Asymmetrization or desymmetrization of diols or diacetates using lipases
 - 2.4. Kinetic resolution of racemic amines using lipases in organic solvents
 - 2.5. Classical kinetic resolutions using epoxide hydrolases
 3. Use of oxidoreductases
 - 3.1. Alcohol dehydrogenases
 - 3.1.1. Bioreductions
 - 3.1.2. Biooxidations
 - 3.1.3. Deracemizations combining biooxidation and bioreduction processes
 - 3.2. Bioxygenations using oxygenases
 4. Use of lyases
 - 4.1. Synthesis of chiral cyanohydrins using oxynitrilases
 - 4.2. Aldolases for the production of chiral pyridines
 5. Concluding remarks
- Acknowledgments
- References

Asymmetric synthesis of substituted piperazines

438

Jean-Charles Quirion

1. Introduction
2. Resolution and diastereomeric separation
 - 2.1. Chemical resolution
 - 2.2. Enzymatic resolution

- 2.3. Diastereomeric separation
- 3. Reduction of 2-keto and diketopiperazines
 - 3.1. Reduction of 2-ketopiperazines
 - 3.2. Reduction of 2,3-diketopiperazines
 - 3.3. Reduction of 2,5-diketopiperazines
- 4. Reduction of tetrahydropyrazines
 - 4.1. Reduction of chiral tetrahydropyrazines
 - 4.2. Asymmetric hydrogenation of tetrahydropyrazines
- 5. Reductive cyclization of diamines
 - 5.1. Diastereoselective cyclization
 - 5.2. Enantioselective cyclization
- 6. Cyclization of diaminoalcohols
- 7. Cyclization of diamines
 - 7.1. Nucleophilic substitution
 - 7.2. Reductive amination
 - 7.3. Allylic substitution
- 8. Amination and carboamination of olefins
- 9. Direct functionalization of substituted piperazines
 - 9.1. Selective alkylation of substituted piperazines
 - 9.2. *N*-Selective functionalization
- 10. Conclusions
- References

Microwave assisted synthesis of functional oligothiophenes

460

Manuela Melucci and Giovanna Barbarella

- 1. Introduction
 - 1.1. Oligothiophenes scenario
 - 1.2. Ring-by ring growth through metal catalyzed cross-coupling reaction
- 2. Solvent-free microwave assisted Suzuki coupling
 - 2.1. Unsubstituted quater- and quinquethiophene
 - 2.2. Self-affinity and electrical properties of **T5**
 - 2.3. Methyl substituted sexithiophene
- 3. Liquid phase microwave assisted Suzuki coupling (less soluble oligomers)
 - 3.1. Rigid core thiophene co-oligomers with liquid crystalline properties
- 4. Microwave assisted synthesis of oligothiophene semiconductors in aqueous media using silica and chitosan supported Pd catalysts
 - 4.1. Optimization of reaction conditions
 - 4.2. Extension to other substrates
- 5. Conclusions
- References

SYNTHETIC ACCESSIBILITY TO PROTOPORPHYRIN-IX, CHLOROPHYLL *a* AND (2*R*)-PHYTOCHROMOBILIN AND OTHER BIOLOGICALLY IMPORTANT PYRROLE DERIVATIVES IN ANY ¹³C AND ¹⁵N ENRICHED ISOTOPIC FORM

Prativa B. S. Dawadi* and Johan Lugtenburg

Leiden Institute of Chemistry, Leiden University, P.O. Box 9502, NL-2300 RA Leiden,
The Netherlands (e-mail: p.dawadi@chem.leidenuniv.nl)

Abstract. Recently, the synthesis of 3-cyano-4-methylpyrrole and 3-formyl-4-methylpyrrole has been published such that ¹³C, ¹⁵N-incorporation of these systems at any position or a combination of positions have become accessible. In this review paper we explore the possibilities of a similar access to any ¹³C, ¹⁵N isotopomer of porphobilinogen, chlorophyll *a*, protoporphyrin-IX, (2*R*)-phytychromobilin, (2*R/S*)-phycocyanobilin, bilirubin and other pyrrole systems. This review is based on a small number of highly isotopically enriched pyrrole systems and other building blocks of isotopically enriched tetrapyrrole systems that have been published. Although no synthetically ¹³C and ¹⁵N-enriched chlorophyll *a* molecule has been published, it has been clear that based on information in the literatures chlorophyll *a* as well as all tetrapyrrole molecules we discuss in this paper are now synthetically accessible in any stable isotope labeled form.

Contents

1. Introduction
2. Synthesis and discussion
 - 2.1. Isotopically labeled pyrroles, protoporphyrins and related derivatives
 - 2.1.1. [**1-¹⁵N**]-3-Cyano-4-methyl-1*H*-pyrrole
 - 2.1.2. Benzyl 3-(2-methoxycarbonylethyl)-4-methoxycarbonylmethyl-5-methyl[**2-¹³C**]-pyrrole-2-carboxylate, benzyl 3-(2-methoxycarbonylethyl)-4-methoxycarbonyl-methyl[**2-¹³C**]-pyrrole-2-carboxylate, benzyl 5-([**13C**]-**formyl**)-3-(2-methoxycarbonyl-ethyl)-4-methoxycarbonylmethyl[**2-¹³C**]-pyrrole-2-carboxylate and 2-([**13C**]-**formyl**)-4-(2-methoxycarbonylethyl)-3-methoxycarbonylmethyl[**5-¹³C**]-pyrrole
 - 2.1.3. Ethyl 3,5-dimethyl-4-ethyl[**1-¹⁵N**]-pyrrole-2-carboxylate and ethyl 3,5-dimethyl-4-ethyl[**3-¹³C**]-pyrrole-2-carboxylate
 - 2.1.4. [**11-¹³C**]-Porphobilinogen
 - 2.1.5. Dibenzyl 3,5-dimethyl[**2,3,4,5-¹³C**]₄-pyrrole-2,5-dicarboxylate
 - 2.1.6. 5-Substituted 2-pyrrole esters
 - 2.1.7. 3-Cyanopyrrole, 3-cyano-4-methylpyrrole, pyrrole-3-carboxylate and 4-methylpyrrole-carboxylate
 - 2.1.8. [**2-¹³C**]-3-Cyano-4-methyl-3-pyrrolin-2-one and [**3-¹³C**]-3-cyano-4-methyl-3-pyrrolin-2-one
 - 2.1.9. 3,4-Disubstituted pyrrolinones and 3-(**pentadeuteroethyl**)-4-methylpyrrolin-2-one
 - 2.1.10. Chlorophyll *a*
 - 2.1.11. Protoporphyrin-IX, hemin and biliverdin

2.1.12. (2*R*)-Phytochromobilin and (2*R/S*)-phycocyanobilin

2.1.12.1. The synthesis of pyrromethenone **124** (A,B-ring segment of phytochromobilin)

2.1.12.2. The synthesis of pyrromethenone **132** (C,D-ring segment of phytochromobilin)

2.1.12.3. Coupling of pyrromethenones **124** and **132** to form (2*R*)-phytochromobilin

2.1.13. Bilirubin and its analogs

3. Conclusion

Acknowledgments

References

1. Introduction

Heme proteins, like hemoglobin, myoglobin and cytochromes play indispensable roles in life processes such as an oxygen transport, storage of oxygen and transfer of electrons and the metabolism of the substrates.¹ Proteins containing (bacterio)chlorophylls are intimately involved in the capture of light and the conversion of electronic energy into chemical energy stored in energy rich molecules. These processes are the basis for the energy and the material requirements for living systems in the earth. Both bacteriochlorophylls and chlorophylls have tetra- and dihydroporphyrin Mg complexes as prosthetic group, respectively. Phytochromobilin forms the coloured part of phytochrome, the protein that serves “colour vision” in plants.

Molecules enriched with stable isotopes such as ²H, ¹³C and ¹⁵N have been used as important tools to obtain otherwise unavailable informations about biosynthesis and metabolism, *e.g.* 66 g of 35% ¹⁵N-enriched glycine ingested by Shemin in 1945 has been used to establish the nitrogen atoms in the heme group of hemoglobin derived from the amino group of glycine and that the contents of the erythrocytes during their average life time of 127 days are not in dynamic equilibrium with the rest of the constituents of the bodies.^{2,3} The use of the isotope sensitive technique ¹³C NMR spectroscopy in the metabolic studies allows a tremendous increase in the analytical power. Battersby and co-workers described the conversion of [2-¹³C]-, [11-¹³C]- and [2,11-¹³C₂]-porphobilinogen (Figure 4) in the body into uroporphyrinogen III and coproporphyrinogen III.⁴ Scott and co-workers reported the formation of porphobilinogen in living *Rhodobacter spheroides* cells which have been incubated with [5-¹³C]-aminolevulinic acid **29** (in Scheme 4) *via in vivo* ¹³C NMR spectroscopy.⁵

At the same time, as more and more isotopically enriched hemes and precursors became synthetically available the analytical tools to detect the labeling were further developed; *via* ¹H NMR spectroscopy the relative orientation of heme nucleus in ferricytochrome b₅ which had been reconstituted with CD₃-labeled heme **105** (Figure 12) have been established.⁶ Very recently, the ¹³C photo-CIDNAP MAS NMR spectra of membrane fragments of *Heliobacillus mobilis* that have been grown on media containing [4-¹³C]-aminolevulinic acid have been observed.⁷

Besides NMR spectroscopy, the vibrational techniques such as resonance Raman spectroscopy has been applied in the heme protein field.⁸ In this case, some of the vibrations coupled to an electronic transition show enhanced inelastic light scattering up to 10⁶ fold. In the resonance Raman spectroscopy, only vibrations from the heme group without interference of the vibrations of the rest of the protein are observed. Very recently, *via* coherence spectroscopy, the low frequency vibrations of heme have been investigated.⁹ In this frequency region, the vibrations in the heme group are caused by proton specific interactions with the

chromophore. Also resonance hyper-Raman spectra of zinc phthalocyanine have been reported.¹⁰ This new technique may also show great expectations for application in the field of heme protein.

It is clear that the full potential of these non-invasive techniques in the heme protein fields will not be realized as long as there will be no synthetic access to full set of isotopomers of the heme prosthetic group. The only way to obtain access to whole library of isotopomers in question is total organic synthesis of the required highly enriched isotopomers which will then be used to regenerate the functioning heme protein in tailor-made isotopically labeled form in the prosthetic group. These materials can then be studied with the noninvasive spectroscopy techniques to get structural information at the atomic level without perturbation. Comparison of intermediate I with those of I+1 in the biological processes will also give the required functional information at the atomic level such as changes in protonation state, bond length etc. on the time scale involved.¹¹ In order to obtain synthetic access to all possible isotopomers of the heme group, first the required pyrrole building blocks have to be obtained in all isotopically enriched forms, which then subsequently can be utilized to obtain the biologically important porphyrin derivatives.

Only very recently an efficient pyrrole synthesis has been published which allows access to all stable isotope enriched forms.¹² Although we have reported only [1-¹⁵N] isotopomer, our synthetic Scheme can be used to prepare any isotopomeric form without any change. A guiding principle in this study has been a minimal number of synthetic steps which are convergent and use of stoichiometric amounts of reagents. Also structural symmetric reagents which are made asymmetric *via* isotope substitution have been avoided because their use leads to mixtures of different isotopomers which are inseparable. These restrictions are essential to produce the target molecule in the precisely defined isotopomeric form with 99% isotope incorporation. Also the access to a whole library of isotopomers of pyrroles is essential because many pyrroles have important biological, medical and pharmaceutical properties themselves. The isotopomers of these systems allow the study of their metabolism *in vivo* in exquisite detail. Earlier a small number of isotopically enriched pyrroles have been reported in literature. In the meantime essential building blocks that are involved in these syntheses are now published in all isotopically enriched forms in the literature. They have been used for the syntheses of isotopically enriched biologically important systems. The use of published synthesis allows all the materials described under 2.1.1.–2.1.13. to be synthesized in any isotopically labeled form. In this paper, we will discuss all possibilities for the whole set of isotopomers of pyrroles, porphyrins, chlorins and other essential tetrapyrrole systems.

In this paper, we mainly focus on ¹³C and ¹⁵N-enriched building blocks such that all atoms in the molecular skeleton of the tetrapyrrole system can be labeled. We haven't focus on ²H system because ²H occupies the peripheral positions in the molecular system and it is more prone to isotope loss and scrambling during the synthetic process. However the study of the chemical Schemes for ¹³C incorporation can easily be adjusted to ²H incorporation also.

2. Synthesis and discussion

2.1. Isotopically labeled pyrroles, protoporphyrins and related derivatives

2.1.1. [1-¹⁵N]-3-Cyano-4-methyl-1H-pyrrole

The essential step in the sequence of Scheme 1 is the Wittig coupling between the anion of diethyl {1-cyano-2-[(diphenylmethylene)amino]ethyl}phosphonate **1** and 1,1-dimethoxyacetone **2** which afforded a *E,Z* mixture of 2-[[[(diphenylmethylene)amino]methyl]-4,4-dimethoxy-3-methylbut-2-enenitrile **3**.¹² This is

the first time that a Wittig coupling has been applied in pyrrole synthesis. Product **3** in one pot procedure undergoes deprotection to form the required amino and aldehyde groups which cyclise spontaneously under acidic conditions to afford 4-cyano-3-methylpyrrole **4**. Dibal reduction of cyano group gave 3-methylpyrrole-4-aldehyde **5**. Base catalyzed reaction of product **4** with benzyl bromide yielded 1-benzyl-3-methyl-4-cyanopyrrole (not indicated in Scheme).

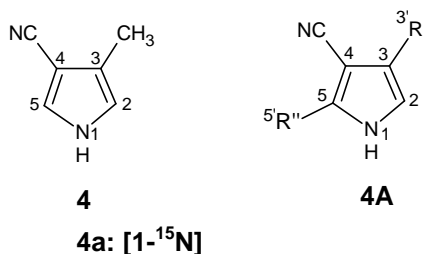
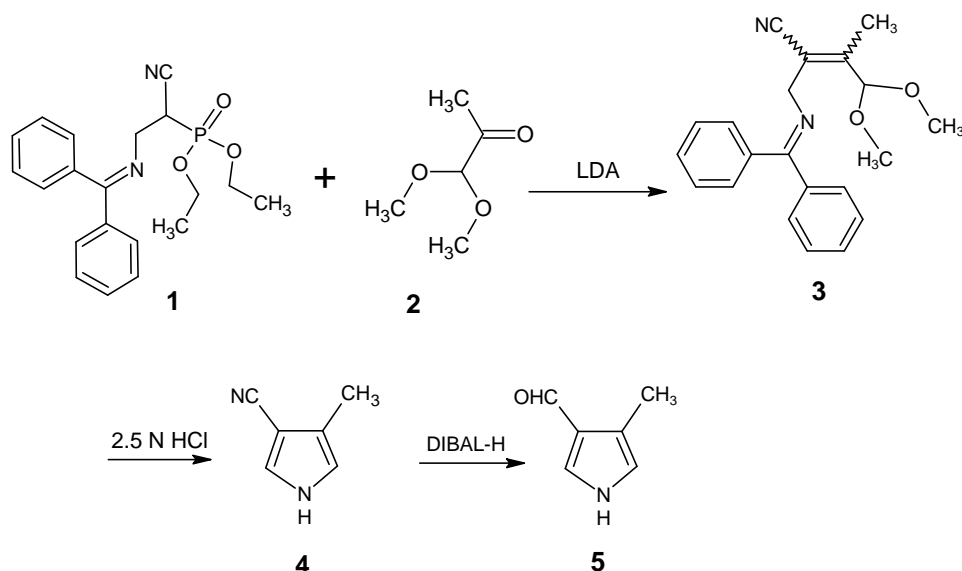

Figure 1. Structure and numbering of 3-cyano-4-methylpyrrole **4** and 3,5-disubstituted 4-cyanopyrrole **4A**.

Phthalimide **6** is commercially obtainable in ¹⁵N-incorporated form. It is used to prepare the ¹⁵N-enriched Wittig reagent *via* reactions in Scheme 2 to afford [1-¹⁵N]-3-cyano-4-methyl-1*H*-pyrrole **4a** (Figure 1) *via* Scheme 1.



Scheme 1. Reactions to obtain 3-cyano-4-methylpyrrole **4** and 3-formyl-4-methylpyrrole **5** in any stable isotope enriched form.

In Scheme 2, it is indicated how product **1** is prepared by base (potassium phthalimide) catalyzed addition of phthalimide **6** to acrylonitrile **7** to give phthalimido propionitrile **8**. Exchange of the phthalimido group for the diphenyl methyleneamino group gave 3-[(diphenylmethylene)amino]propionitrile **9** which is deprotonated next to the nitrile function and subsequently phosphorylated with diethyl chlorophosphate to give the anion of **1**, directly.

The C and N atoms of products **4** and **5** are derived from 1,1-dimethoxyacetone **2**, phthalimide **6** and acrylonitrile **7**. The preparation of all isotopomeric forms of acrylonitrile and 1-chloroacetone (the precursor of 1,1-dimethoxyacetone) have been described in the literature.^{11,13} It is to be expected that homologous of **4** can also be easily prepared in all possible isotopomeric forms with different substituents at positions 3 and 5 as indicated in structure **4A** (see Figure 1).

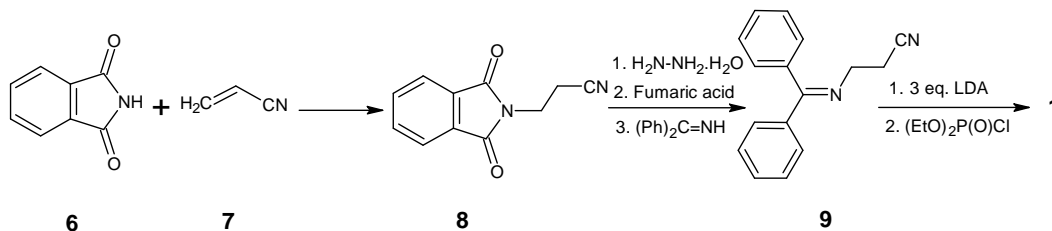

Scheme 2. Preparation of diethyl{1-cyano-2-[(diphenylmethylene)amino]ethyl}-phosphonate **1** from phthalimide **6** and acrylonitrile **7**.

Besides acrylonitriles, other conjugated nitriles are expected to react in a similar way. A whole range of 1,1-dimethoxy ketones is available *via* SeO₂ oxidation of methyl ketones.¹⁴ This means that also substituted pyrroles with general structure **4A** (Figure 1) should be similarly available. Formylation gives the carbaldehyde function at position 2 in structure **4A** that can be ¹³C-enriched. The basic structures of **4** and **5** can be easily converted simply into a host of other isotopically labeled pyrroles *via* DIBAL, NaBH₄ reduction, base catalyzed alkylation, etc.

2.1.2. Benzyl 3-(2-methoxycarbonylethyl)-4-methoxycarbonylmethyl-5-methyl[2-¹³C]-pyrrole-2-carboxylate, benzyl 3-(2-methoxycarbonylethyl)-4-methoxycarbonylmethyl[2-¹³C]pyrrole-2-carboxylate, benzyl 5-([¹³C]-formyl)-3-(2-methoxycarbonylethyl)-4-methoxycarbonylmethyl[2-¹³C]-pyrrole-2-carboxylate and 2-([¹³C]-formyl)-4-(2-methoxycarbonylethyl)-3-methoxycarbonylmethyl[5-¹³C]-pyrrole

Battersby and co-workers reported the syntheses of ¹³C-enriched pyrroles during their porphyrin studies with 90% ¹³C-incorporation.¹⁵ At that time, building blocks with only 89% ¹³C-incorporation were available. Nowadays 99% ¹³C-enriched reagents are commercially available and also in the case when high 99% incorporation is required, it can be easily reached. They carried out the reactions depicted in Scheme 3 which started with acetic acid **10**. Bromoacetic acid which is obtained from acetic acid **10** by Hell-Volhard-Zelinsky reaction is treated with potassium cyanide to give cyanoacetic acid **11**. Cyanoacetic acid is treated with 10M HCl at 100 °C to get malonic acid which is treated with benzyl alcohol in the presence of acid to give dibenzyl malonate. The product is treated with sodium nitrite in acetic acid to give the corresponding oxime **12** (dibenzyl hydroxyiminomalonate). The product **15** has been prepared from *tert*-butyl acetoacetate **13** which is acylated with 3-methoxycarbonylpropionyl chloride to form methyl 4,6-dioxoheptanoate **14**. The product **14** is treated under basic conditions with methyl chloroacetate to give dimethyl 3-acetyl-4-oxoheptanedioate **15**. In the Knorr condensation of **12** and **15**, besides the reported product **16**, the formation of a second isomer is expected. However, only product benzyl 3-(2-methoxycarbonylethyl)-4-methoxycarbonylmethyl-5-methylpyrrole-2-carboxylate **16** is mentioned in the manuscript. The methyl group at

position 5 is converted into an aldehyde group by the reaction with sulphuryl chloride. Subsequent decarbonylation with tris(triphenylphosphine)rhodium(I) chloride resulted benzyl 3-(2-methoxycarbonylethyl)-4-methoxycarbonylmethylpyrrole-2-carboxylate **17**. *Via* Vilsmeier-Haack formylation, an aldehyde is introduced at position 5 to give as product benzyl 5-formyl-3-(2-methoxycarbonylethyl)-4-methoxy-carbonylmethylpyrrole-2-carboxylate **18**. Saponification and decarboxylation of benzyl carboxylate at position 2 gave 2-formyl-4-(2-methoxycarbonylethyl)-3-methoxycarbonylmethylpyrrole **19**.

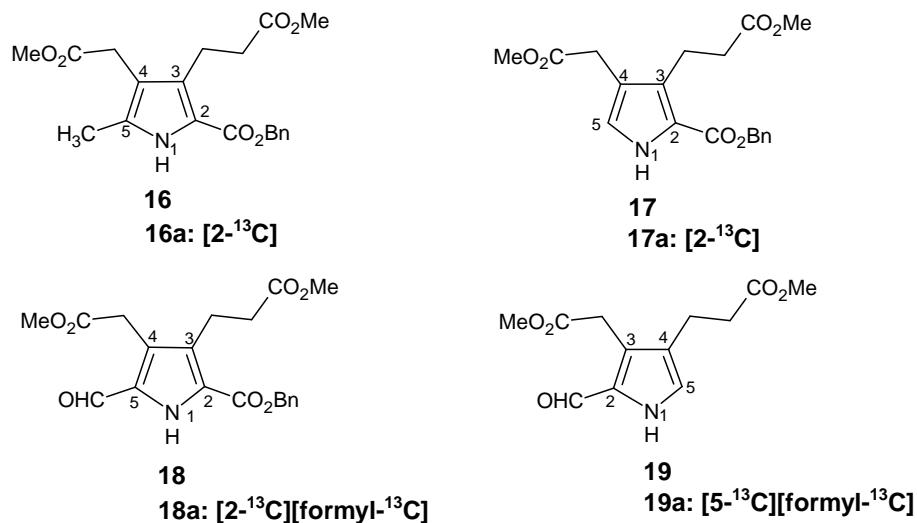

Figure 2. Structures and numbering of benzyl 3-(2-methoxycarbonylethyl)-4-methoxycarbonylmethyl-5-methylpyrrole-2-carboxylate **16**, benzyl 3-(2-methoxycarbonylethyl)-4-methoxycarbonylmethylpyrrole-2-carboxylate **17**, benzyl 5-formyl-3-(2-methoxycarbonylethyl)-4-methoxycarbonylmethylpyrrole-2-carboxylate **18** and 2-formyl-4-(2-methoxycarbonylethyl)-3-methoxycarbonylmethylpyrrole **19**.

The authors have accomplished the conversions also by starting with [2-¹³C]-acetic acid. This resulted in the preparation of benzyl 3-(2-methoxycarbonylethyl)-4-methoxycarbonyl-methyl-5-methyl[2-¹³C]-pyrrole-2-carboxylate **16a** and benzyl 3-(2-methoxycarbonylethyl)-4-methoxycarbonylmethyl[2-¹³C]-pyrrole-2-carboxylate **17a**. Reaction of **17** with [formyl-¹³C]-dimethylformamide afforded benzyl 5-(¹³C)-formyl)-3-(2-methoxycarbonylethyl)-4-methoxycarbonylmethyl[2-¹³C]-pyrrole-2-carboxylate **18a** and 2-(¹³C)-formyl)-4-(2-methoxycarbonylethyl)-3-methoxycarbonylmethyl[5-¹³C]-pyrrole **19a** (Figure 2).

Acetic acid, potassium cyanide and sodium nitrite are commercially available in all ¹³C and ¹⁵N-enriched forms. This means that, besides carbon atoms at position 2 and 5, nitrogen at position 1 in **16** can be enriched using Na¹⁵NO₂ in oxime **12**. Only the positions 3 and 4 that result from dimethyl 3-acetyl-4-oxoheptanedioate **15**, the central reagent in the Scheme 3, can not be isotopically enriched. However in the mean time a Scheme has been published for the preparation of [1,2,3,4,5-¹³C₅]-5-aminolevulinic acid **29a** in any isotopically labeled form (Scheme 4).¹⁶ *Via* the Scheme 4, 4,6-dioxoheptanoic acid is accessible in all isotopically labeled forms. Product 4,6-dioxoheptanoic acid **27** can be easily converted into dimethyl 3-acetyl-4-oxoheptanedioate **15** (*vide infra*).

The reactions depicted in Scheme 4 starts with triethyl phosphonoacetate **20** which is obtained *via* an Arbuzov reaction between ethyl bromoacetate and triethyl phosphite.¹⁶ A Wittig coupling of **20** with acetone afforded ethyl 3-methylbut-2-enoate **21**. Subsequent LiAlH₄ reduction and bromination of allylic alcohol

gave 1-bromo-3-methyl-2-butene **22**. A S_N2 reaction of **22** with the anion of acetonitrile **23** yielded 5-methyl-4-hexenenitrile **24**. After ozonolysis and reductive work up and subsequent acetal formation product 3-(1',3'-dioxolan-2'-yl)propanenitrile **25** is obtained. During this sequence, the dimethyl methylene protective unit of **24** is removed as acetone during ozonolysis.

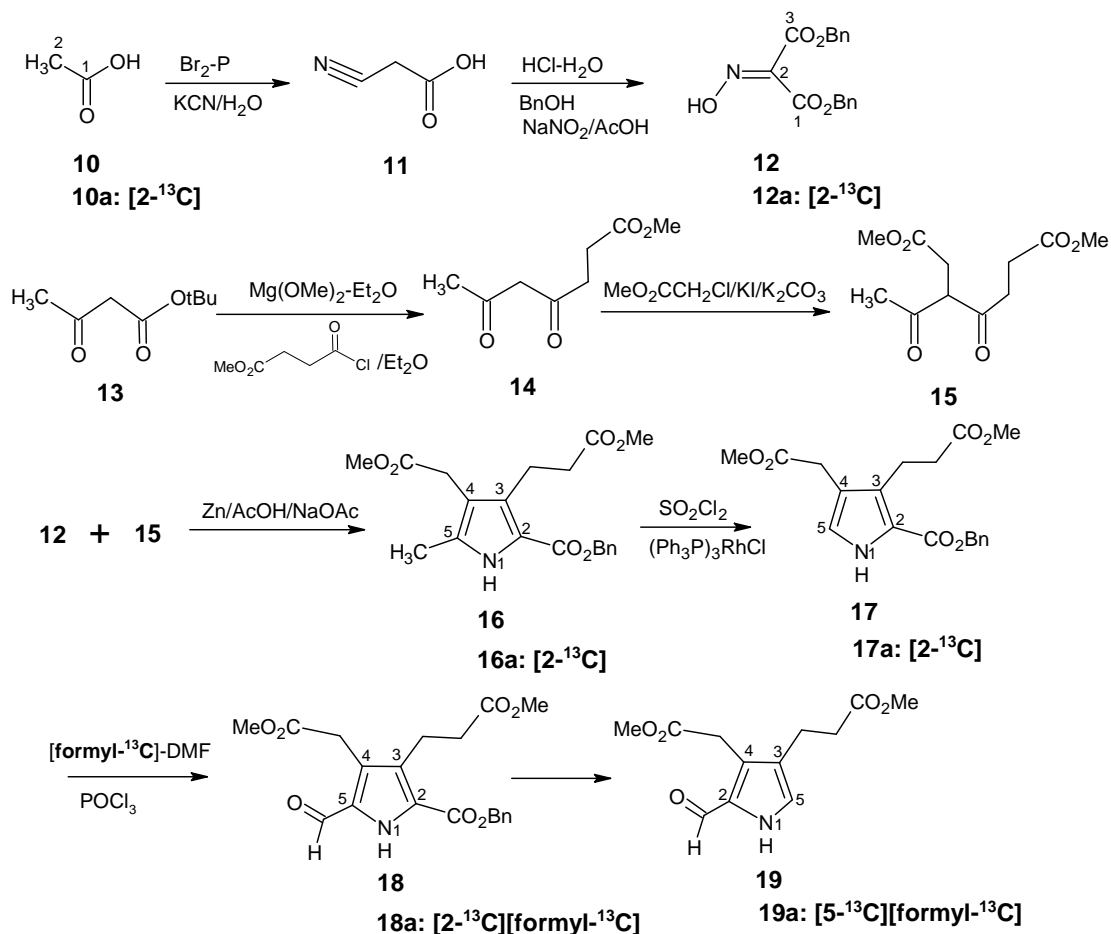

Scheme 3. Reactions to prepare benzyl 3-(2-methoxycarbonylethyl)-4-methoxycarbonylmethyl-5-methyl [2-¹³C]-pyrrole-2-carboxylate **16a**, benzyl 3-(2-methoxycarbonylethyl)-4-methoxycarbonylmethyl [2-¹³C]pyrrole-2-carboxylate **17a**, benzyl 5-(¹³C-formyl)-3-(2-methoxycarbonylethyl)-4-methoxycarbonylmethyl[2-¹³C]-pyrrole-2-carboxylate **18a** and 2-(¹³C-formyl)-4-(2-methoxycarbonylethyl)-3-methoxycarbonylmethyl[5-¹³C]-pyrrole **19a**.

After a Blaise reaction of **25** with zinc/ethyl 2-bromoacetate product ethyl 5-(1',3'-dioxolan-2'-yl)-3-oxopentanoate **26** is obtained. Deprotection and oxidation of aldehyde function with chromium (VI) oxide in acetic acid gave 6-ethoxy-4,6-dioxohexanoic acid **27**. Treatment of **27** with sodium nitrite under acidic condition afforded the corresponding oxime which after reductive acetylation yielded 5-acetylamino-6-ethoxy-4,6-dioxohexanoic acid **28**. Treatment of **28** with 4N HCl afforded 5-aminolevulinic acid **29**. All carbon and nitrogen atoms in **29** can be obtained in ¹³C and ¹⁵N-enriched forms because all atoms those incorporated in the system results from the commercial reagents which are available in any isotope enriched form.

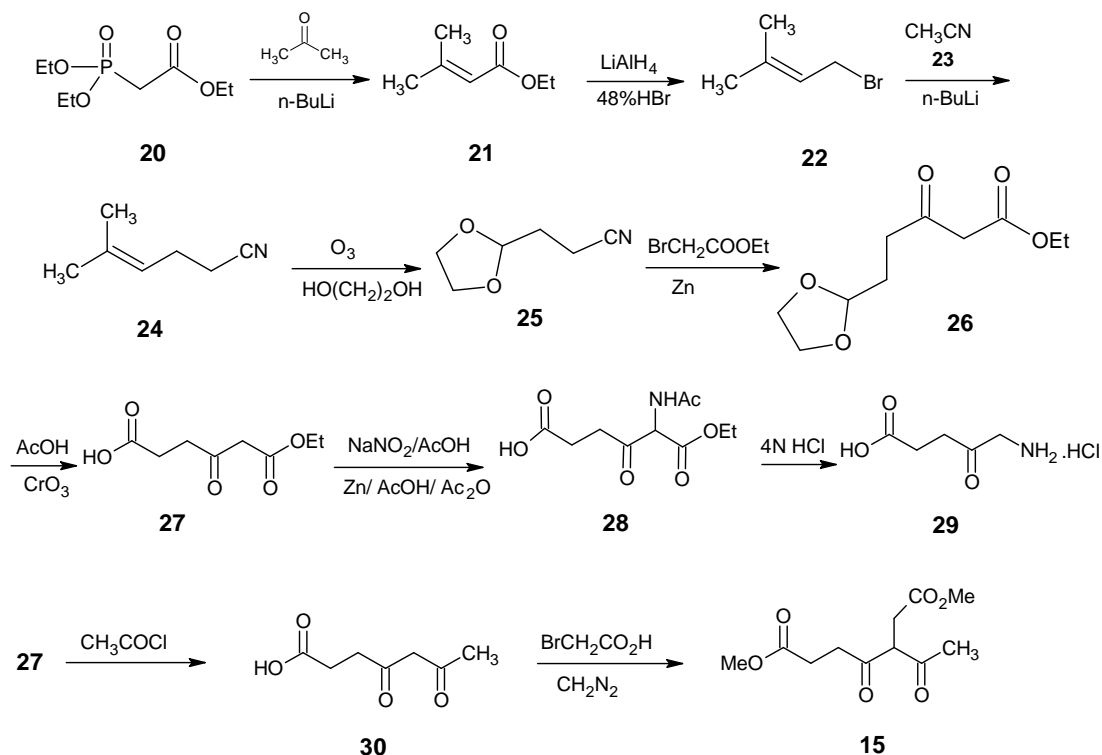

Scheme 4. Preparation of 5-aminolevulinic acid **29** and 6-ethoxy 4,6-dioxohexanoic acid **27** in any stable isotope enriched form. Conversion of **27** into dimethyl 3-acetyl-4-oxoheptanedioate **15** (central building block of Scheme 3) *via* acetylation and alkylation.

6-Ethoxy-4,6-dioxohexanoic acid **27** can be simply converted into dimethyl 3-acetyl-4-oxoheptanedioate **15**. *Via* acetylation with acetyl chloride, saponification and decarboxylation of **27** gives 4,6-dioxoheptanoic acid **30** (which is the acid derivative of **14**). Treatment of the anion of **30** with bromoacetic acid gives 3-acetyl-4-oxoheptanedioic acid which, after treatment with diazomethane, gives the corresponding dimethyl ester **15**. All the reagents used in Scheme 4 are commercially available in any isotopically labeled form which means that **16**, **17**, **18** and **19** are now accessible in any isotopically labeled form *via* published synthetic Schemes.

2.1.3. Ethyl 3,5-dimethyl-4-ethyl[1- ^{15}N]-pyrrole-2-carboxylate and ethyl 3,5-dimethyl-4-ethyl[3- ^{13}C]-pyrrole-2-carboxylate

Spiro and co-workers reported the synthesis of the compounds **33a** and **33b**.¹⁷

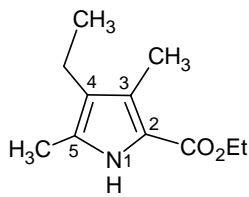

33

33a: [1- ^{15}N] **33b:** [3- ^{13}C]

Figure 3. Structure and numbering of ethyl 3,5-dimethyl-4-ethylpyrrole-2-carboxylate **33**.

These products are obtained *via* Scheme 5. The oximation of ethyl acetoacetate **31** gave the corresponding oxime which is reduced with zinc dust and acetic acid in the presence of ethyl 2-ethyl-3-oxobutyrate **32** to give ethyl 3,5-dimethyl-4-ethylpyrrole-2-carboxylate **33**. Using Na¹⁵NO₂ for oximation of ethyl acetoacetate **31** and NaNO₂ for oximation of ethyl [**3-¹³C**]-acetoacetate products **33a** and **33b** are obtained, respectively.

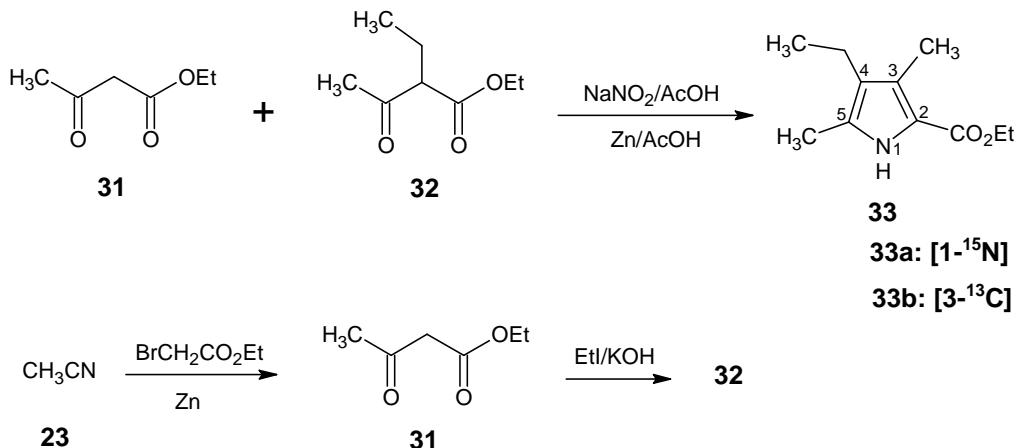

Scheme 5. Preparation of ethyl 3,5-dimethyl-4-ethylpyrrole-2-carboxylate **33** *via* Knorr reaction of ethyl 3-oxobutyrate **31** and ethyl 2-ethyl-3-oxobutyrate **32**.

In the mean time, the ethyl acetoacetate **31** has been prepared in literature in all possible isotope forms *via* Blaise reaction of ethyl bromoacetate and acetonitrile **23**.¹¹ Ethyl iodide is commercially available in all isotopic forms which means **32** can also be easily obtained in all ¹³C-enriched forms. The authors have converted **33a** and **33b** into the [¹⁵N₄]- and [1,3,5,7-¹³C₄]-etioporphyrins I.

In this way, all synthons in Scheme 5 are either commercially available or easily prepared in all isotopomers. This means that ethyl 3,5-dimethyl-4-ethylpyrrole-2-carboxylate **33** is now accessible in all stable isotope enriched forms. Also methyl iodide is available in ¹³C-enriched form which means that Scheme 5 also leads easily to ethyl 3,4,5-trimethylpyrrole-2-carboxylate. This means that all symmetrically ¹³C and ¹⁵N-labeled etioporphyrins I are now accessible. However no etioporphyrin I systems that are asymmetrically labeled with ¹³C and ¹⁵N are accessible *via* this method.

2.1.4. [11-¹³C]-Porphobilinogen

In Scheme 3, it is indicated that product **17** [benzyl 3-(2-methoxycarbonylethyl)-4-methoxycarbonylmethylpyrrole-2-carboxylate] under Vilsmeier-Haack formylation afforded the pyrrole aldehyde **18** [benzyl 5-(formyl)-3-(2-methoxycarbonylethyl)-4-methoxycarbonylmethylpyrrole-2-carboxylate] which, after saponification and decarboxylation, yielded product 2-(formyl)-4-(2-methoxycarbonylethyl)-3-methoxycarbonylmethylpyrrole **19**.¹⁸

Buldain and Valasinas reported that using [formyl-¹³C]-dimethylformamide for the formylation of product **17** [benzyl 2-formyl-4-(2-methoxycarbonylethyl)-3-methoxycarbonylmethylpyrrole-5-carboxylate], product **18** with ¹³C-enrichment in the aldehyde function is obtained.¹⁹ Treatment of this product further with hydroxylamine and subsequent reduction gave [11-¹³C]-porphobilinogen **36a** (Figure 4, Scheme 6).

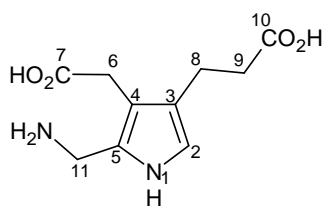

36

36a: [11-¹³C]

Figure 4. Structure and numbering of porphobilinogen **36**.

Battersby and co-workers reported earlier that reductive alkylation with ¹³C-formaldehyde and subsequent chlorination with SO₂Cl₂ converted **37** (the ethyl ester derivative of **17**) into ethyl 5-chloromethyl-3-(2-ethoxycarbonyl-ethyl)-4-ethoxycarbonylmethyl-pyrrole-2-carboxylate **38** (Scheme 6).²⁰ The product **38** is converted into the corresponding azide followed by reduction with H₂ and Pd as catalyst in acidic conditions to afford bicyclic amide **35** which upon hydrolysis afforded porphobilinogen **36**.

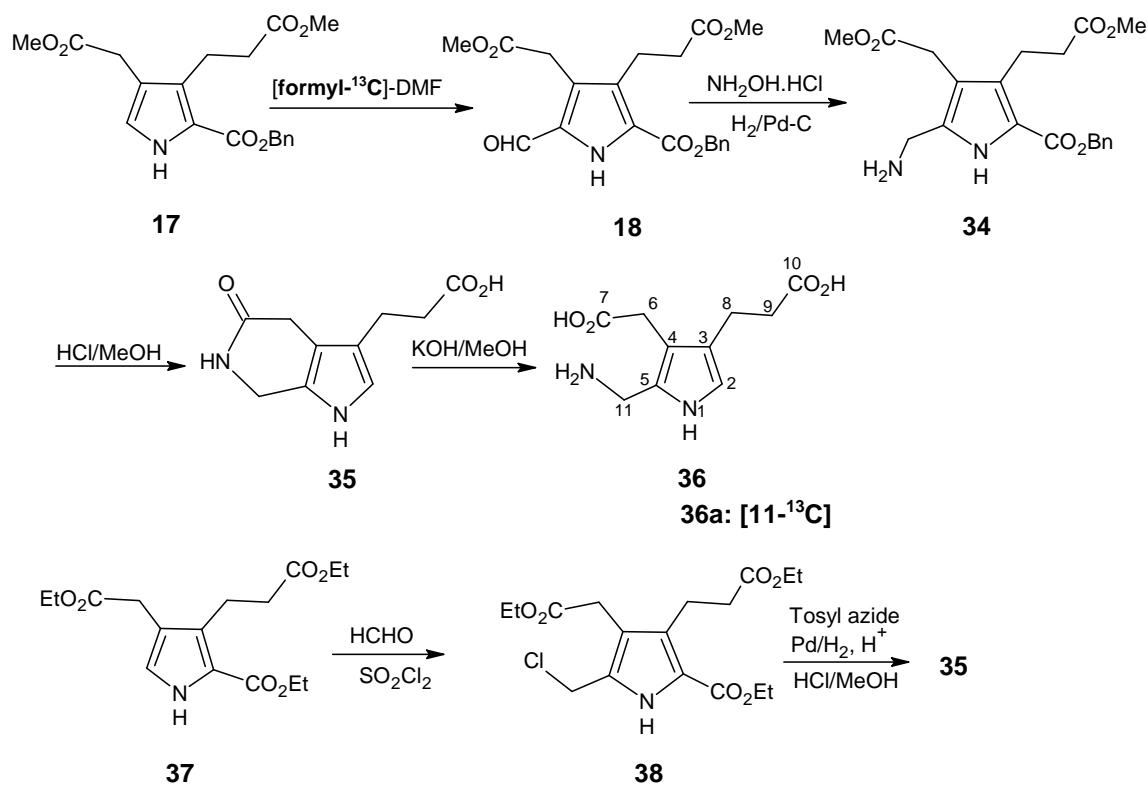

Scheme 6. Preparation of porphobilinogen **36** from benzyl 3-(2-methoxycarbonyl-ethyl)-4-methoxycarbonylmethylpyrrole-2-carboxylate **17**.

In Scheme 4, it is discussed that 6-ethoxy-4,6-dioxoheptanoic acid **27** can be converted into dimethyl 3-acetyl-4-oxoheptanedioate **15** in all possible stable isotopomeric forms. In Scheme 3, the product **15** has been converted into any isotopomer of **17**, **18** and **19**. The reactions in Scheme 6 lead to the access of porphobilinogen **36** with combination of isotope incorporations at any position excluding the NH₂ group of

aminomethyl at position 2. Usually this NH₂ group is lost early during the biosynthetic reaction leading to the porphyrins, chlorins, etc. Therefore, it is in principle not essential to have a ¹⁵NH₂ group to elucidate the role of this atom *via* spectroscopy during the porphyrin biosynthesis.

In Scheme 7, it is indicated how any ¹³C-enriched levulinic acid ester **41** and 5-chloro levulinic acid ester **43** can be prepared and these molecules can be the starting materials for the synthesis of isotopically labeled porphobilinogens.

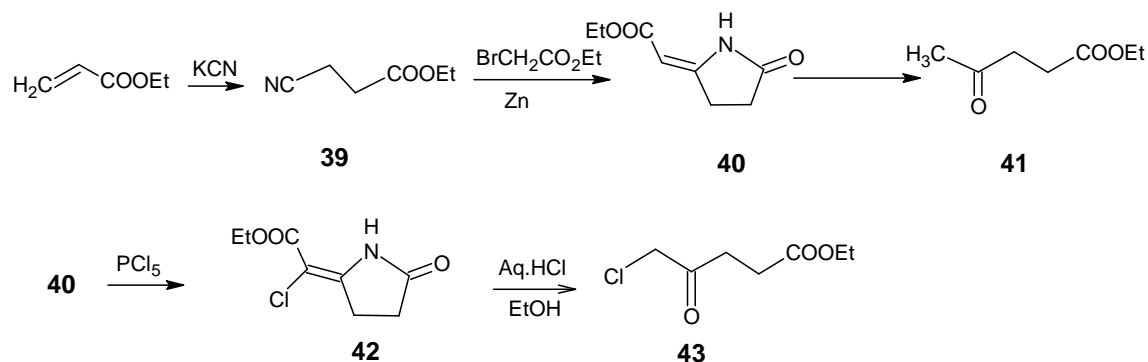

Scheme 7. Reactions to obtain isotopically labeled ethyl levulinate **41** and ethyl 5-chlorolevulinate **43** from ethyl acrylate.

Ethyl acrylate is treated with potassium cyanide in ethanol to give ethyl 3-cyanopropanoate **39** which is employed in a Blaise reaction to afford **40**.¹⁶ Subsequent treatment with aqueous HCl in ethanol gave ethyl levulinate **41** or after treatment with PCl₅ and subsequent hydrolysis, afforded ethyl 5-chlorolevulinate **43**. The complete set of isotopomers of ethyl acrylate *via* simple starting materials has been described earlier by our group. That means in this approach both **41** and **43** are now accessible in any ¹³C-enriched form.

Neier and co-workers have carried out the reactions depicted in the Scheme 8 with natural abundance materials to synthesize *N*-phenyl acetyl protected porphobilinogen **53**.²¹ Levulinic acid **44**, the free acid corresponding to ethyl levulinate **41**, is treated with bromine in methanol giving methyl 5-bromolevulinate **45** which is converted into methyl 5-hydroxylevulinate **46** by formic acid and DBU. Presumably, **43** from Scheme 7 will undergo the same conversion. The product **46** with two equivalents of strong base and two equivalents of trimethylsilyl chloride in the presence of methyl iodide afforded methyl 4,5-di(trimethylsilyloxy)-3-pentenoate **47**.

Product **47**, together with methyl 5-azido-4,4-dimethoxy-pentanoate **48**, in the presence of Lewis acid yielded an aldol product **49**. Treatment of the methyl 5-bromolevulinate **45** with sodium azide and subsequent ketalization gave product **48**. Mitsunobu reaction of the free primary OH group in **48** afforded the diazido derivative **50**. Hydrogenolysis in the presence of palladium on charcoal and pentafluorophenylphenyl acetate afforded the pyrrole **51**, with the loss of nitrogen and the elements of methanol. The aminomethyl group at position 2 is protected as phenyl acetamido derivative. The saponification of the carboxylic esters is effected by lithium hydroxide. Mild hydrogenolysis of the peptide bond in **52** by penicillin G acylase in basic medium gave the *N*-phenyl acetate ammonium salt of porphobilinogen **53**. Access to any ¹³C-isotopomer of **53** is possible by combining the reactions in Scheme 7 and 8. For the incorporation of ¹⁵N in this system, the synthetic Scheme has to be adjusted a bit. Treatment of the methyl

5-bromolevulinate **45** with [$^{15}\text{N}_2$]-hydrazine that is commercially available gives the methyl 5-hydrazido-levulinate which on treatment with sodium nitrite in acid converts it into the methyl 5-azido-levulinate. Acetalization in methanol gives acetal of methyl 5-azido-levulinate. In this molecule, first nitrogen atom of the azide function will be labeled with ^{15}N that will stay in the molecule after all reactions. A similar situation applies for other azido group which can be labeled with ^{15}N similar way.

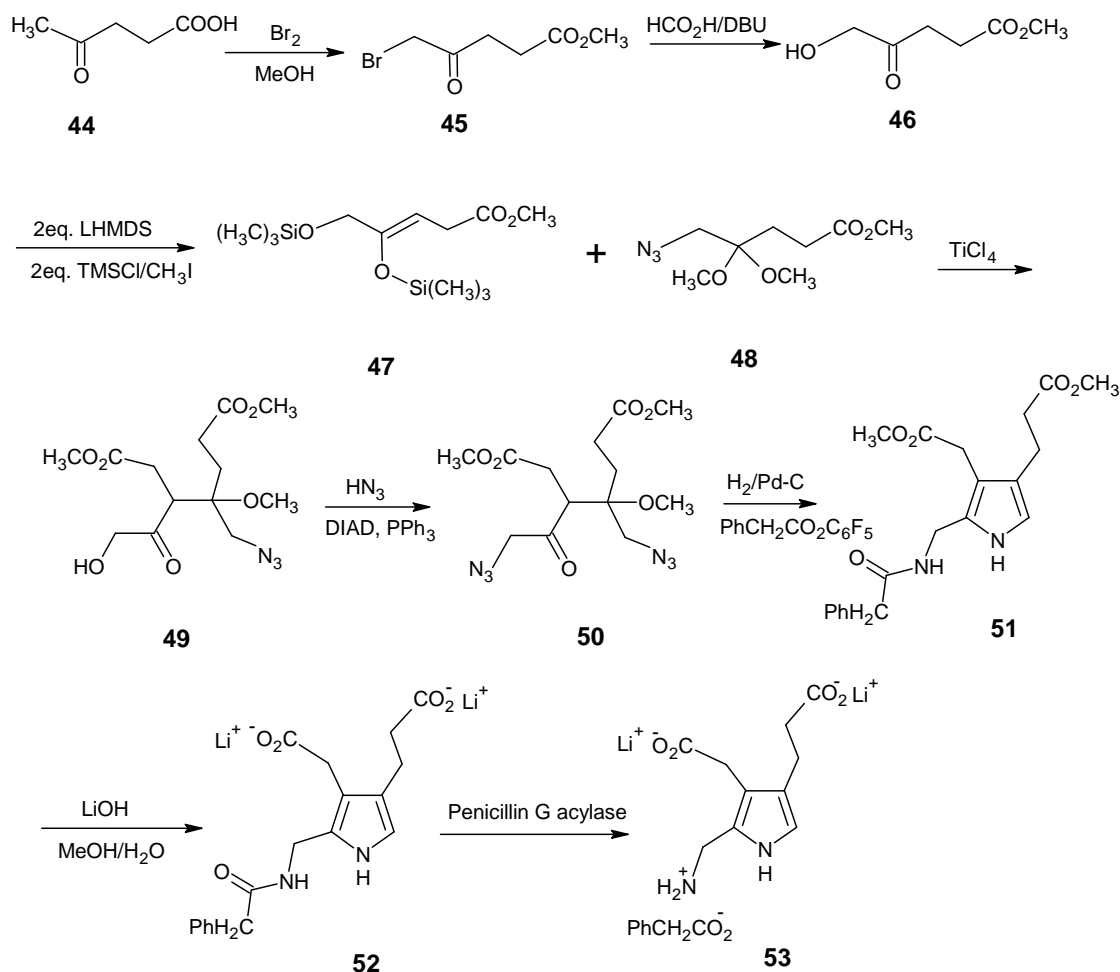

Scheme 8. Preparation of porphobilinogen **53** from levulinic acid **44**.

2.1.5. Dibenzyl 3,5-dimethyl[2,3,4,5- $^{13}\text{C}_4$]-pyrrole-2,4-dicarboxylate

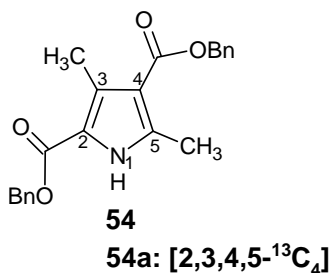

Figure 5. Structure and numbering of dibenzyl 3,5-dimethylpyrrole-2,4-dicarboxylate **54**.

Recently, the synthesis of dibenzyl 3,5-dimethyl[2,3,4,5- $^{13}\text{C}_4$]-pyrrole-2,4-dicarboxylate has been reported starting from benzyl [1,3- $^{13}\text{C}_2$]-acetoacetate.²² Product **54a** is obtained *via* the reactions of Scheme

3. First, benzyl [1,3-¹³C₂]-acetoacetate is treated with NaNO₂ to give the corresponding oxime derivative which is reduced with Zn and acetic acid in the presence of benzyl [1,3-¹³C₂]-acetoacetate to give the corresponding tetrasubstituted pyrrole **54a**. In Scheme 5, it has been reported that all possible isotopomers of acetoacetate are accessible. This means that all isotopomeric forms of **54** are accessible.

2.1.6. 5-Substituted 2-pyrrole esters

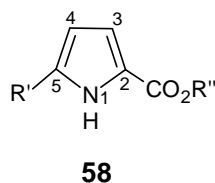
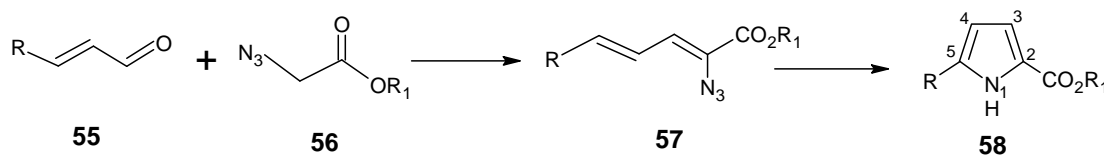

Figure 6. Structure and numbering of 5-substituted -2-pyrrole carboxylic ester **58**.

Recently, a range of 2,5-disubstituted and trisubstituted pyrroles has been synthesized from dienyl azides at room temperature using catalytic amounts of ZnI₂ or Rh₂(O₂CC₃F₇)₄.²³ The dienyl azides are prepared *via* base catalyzed condensation of unsaturated aldehydes **55** and azidoacetic acid esters **56** using the reactions depicted in Scheme 9. *Via* literature procedures, unsaturated aldehydes and azidoacetic acid esters are accessible in any isotopically labeled form. In order to label the nitrogen of **58** [¹⁵N₂]-hydrazine should be used as discussed above.



Scheme 9. Preparation of 3,5-disubstituted pyrroles **58** from dienyl azides **57**.

2.1.7. 3-Cyanopyrrole, 3-cyano-4-methylpyrrole, ethyl pyrrole-3-carboxylate and ethyl 4-methylpyrrole-3-carboxylate

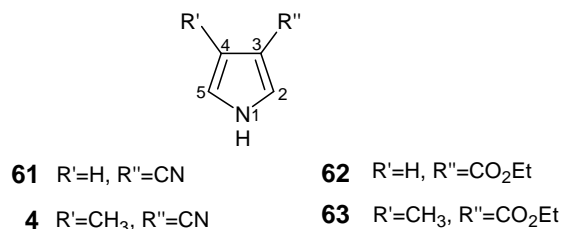

Figure 7. Structure and numbering of 3-cyanopyrrole **61**, 3-methyl-4-cyanopyrrole **4**, ethyl pyrrole-3-carboxylate **62** and ethyl 4-methyl pyrrole-3-carboxylate **63**.

Before the reactions in Scheme 1 have been described 3-cyanopyrrole **61** (R'=H, R''=CN) and 3-cyano-4-methylpyrrole **4** (R'=CH₃, R''=CN), ethyl pyrrole-3-carboxylate **62** (R'=H, R''=CO₂Et) and ethyl

4-methylpyrrole-3-carboxylate **63** ($R'=\text{CH}_3$, $R''=\text{CO}_2\text{Et}$) were prepared by Van Leusen by base catalyzed condensation of TosMIC (tosylmethyl isocyanide) with acrylonitrile, crotonitrile, ethyl acrylate and ethyl crotonate, respectively.²⁴ Acrylonitrile, crotonitrile, ethyl acrylate and ethyl crotonate are commercially available in any stable isotope enriched form. The preparation of TosMIC in all isotopically enriched forms has been described in the literature.²⁵ This means that products **61**, **4**, **62** and **63** in Figure 7 are now accessible in any isotopically enriched form.

2.1.8. [2-¹³C]-3-Cyano-4-methyl-3-pyrrolin-2-one and [3-¹³C]-3-cyano-4-methyl-3-pyrrolin-2-one

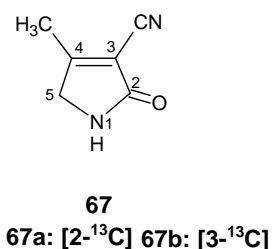
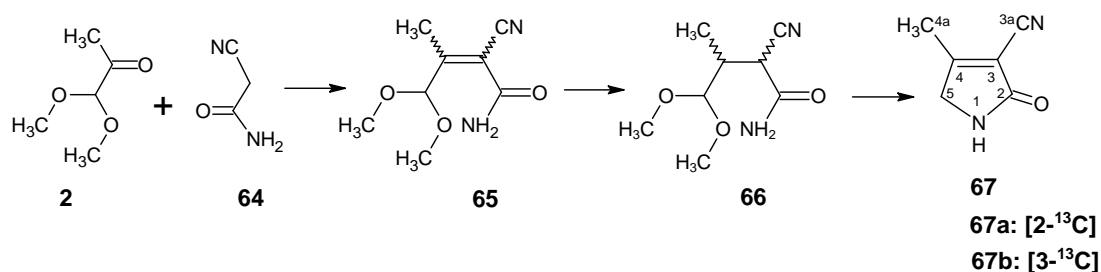

Figure 8. Structure and numbering of 3-cyano-4-methyl-3-pyrrolin-2-one **67**.

In Scheme 10, it is indicated how [2-¹³C]-3-cyano-4-methyl-3-pyrrolin-2-one **67a** and [3-¹³C]-3-cyano-4-methyl-3-pyrrolin-2-one **67b** are efficiently prepared by an extended Knoevenagel condensation.²⁶ 1,1-Dimethoxyacetone **2** and 2-cyanoacetamide **64** condensed together in the presence of acetic acid and ammonium acetate to give *E/Z* mixture of 2-cyano-4,4-dimethoxy-3-methyl-3-butenamide **65**. Simple NaBH₄ reduction of electron poor central double bond gave an enantiomeric mixture of **66**. In a one-pot reaction, the deprotection of aldehyde function at position 5, the cyclisation with the concomitant loss of the water molecule and double bond shift result pyrrolinone **67**. The [2-¹³C] and [3-¹³C] isotopomers of this pyrrolinone molecule have been prepared *via* ¹³C-labeled 2-cyanoacetamides. The source of ¹³C-labeled 2-cyanoacetamide are [1-¹³C]-cyanoacetic acid **59** and [2-¹³C]-cyanoacetic acid **60**. The acids **59** and **60** are converted into corresponding acyl derivatives by the reaction with oxalyl chloride and reacting with NH₃ to give [1-¹³C]-2-cyanoacetamide and [2-¹³C]-2-cyanoacetamide, respectively. Molecules **2** and **64** are accessible in any isotopically enriched form which means that **67** is also accessible in any isotopomeric form.



Scheme 10. The preparation of 3-cyano-4-methyl-3-pyrrolin-2-one **67** starting from 1,1-dimethoxyacetone **2** and 2-cyanoacetamide **64**.

In Scheme 10, just as in Scheme 1, the first step is the formation of carbon-carbon bond that will later become 3-4 bond in the pyrrole derivative. The protective group functionalities present at position 1 and 5 can be deprotected under conditions that are required to form the pyrrole system in one-pot. As far as we know, the reactions in Schemes 1 and 10 are the only pyrrole synthesis where isotope enrichment is effected. This also leads to the preparation of the required products in very few steps.

2.1.9. 3,4-Disubstituted pyrrolinones and 3-(pentadeuteroethyl)-4-methylpyrrolin-2-one

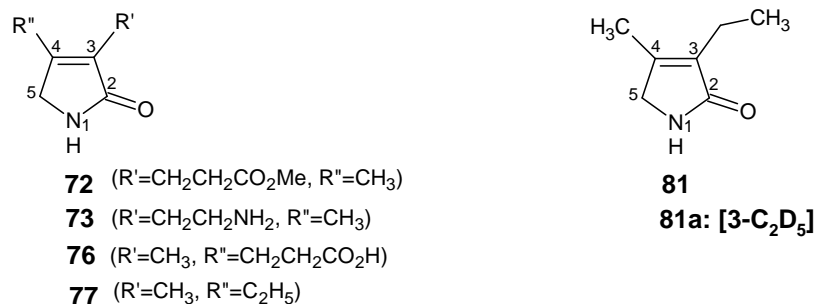
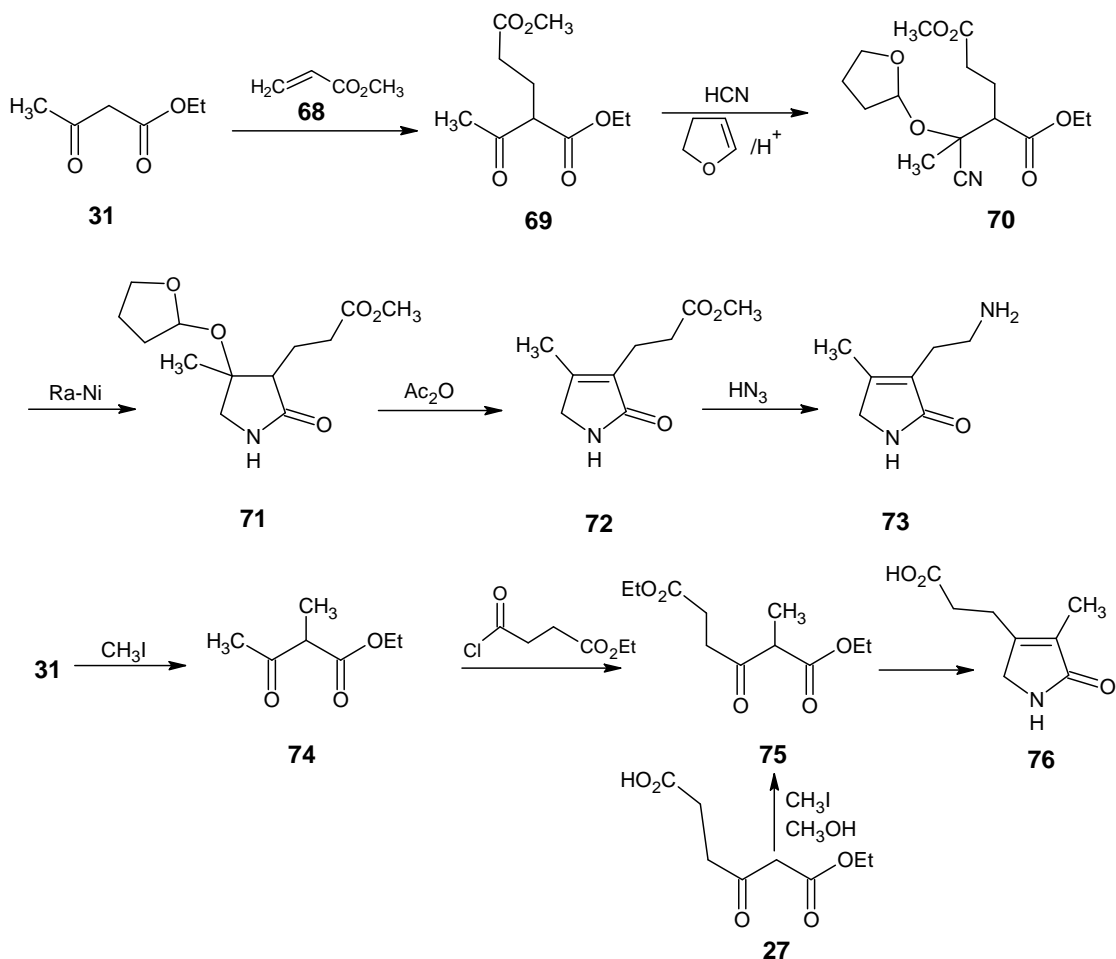

Figure 9. Structure and numbering of 3,4-disubstituted pyrrolinones **72**, **73**, **76**, **77**, **81** and 3-pentadeuteroethyl-4-methyl-3-pyrrolin-2-one **81a**.

Plieninger *et al.* described the synthesis of 3,4-disubstituted pyrrolinones **72**, **73**, **76**, **77** and **81** (Figure 9) *via* the reactions depicted in Scheme 11.²⁷ Ethyl 3-oxobutyrate **31** is condensed with methyl acrylate **68** to form ethyl 2-(2-ethoxycarbonyl)ethyl-3-oxobutyrate **69**. Reaction of **69** with HCN and subsequent protection of the cyanohydrin afforded product **70**. Catalytic reduction of the nitrile function in product **70** and lactam formation gave **71** which, upon deprotection and water elimination in acetic anhydride medium, gave 3-(2-methoxycarbonyl)ethyl-4-methyl-3-pyrrolin-2-one **72**. Treatment of pyrrolinone **72** with hydrazoic acid gave 3-(2-aminoethyl)-4-methyl-3-pyrrolin-2-one **73**. Alkylation of ethyl 3-oxobutyrate **31** with CH_3I gave ethyl 2-methyl 3-oxobutyrate **74**. Product **74** has been treated with 3-ethoxycarbonylpropionyl chloride to form ethyl 2-ethoxycarbonyl-3-oxohexanoate **75**. Product **75** in a similar cyanohydrin reductive treatment afforded product **76**. The reagents **31**, **68** and HCN are now commercially available in all isotopic enriched forms. This means that **72** and **73** are now accessible in any isotopically labeled form. Ethyl 2-ethoxycarbonyl-3-oxohexanoate **75** can also be obtained from 6-ethoxy-4,6-dioxohexanoic acid **27** by the esterification followed by alkylation with CH_3I . Product **27** is accessible in any isotopically labeled form *via* the reactions depicted in Scheme 4. That means product **76** is also available in any isotope labeled form *via* reaction indicated in Scheme 11.

The pyrrolinones 4-ethyl-3-methyl-3-pyrrolin-2-one **77** and 3-ethyl-4-methyl-3-pyrrolin-2-one **81** are first synthesized through its corresponding cyanohydrin by Plieninger.²⁷ Using ethyl 2-methyl-3-oxopentanoate instead of ethyl 2-ethyl-3-oxobutyrate **32** under similar condition the reaction afforded 4-ethyl-3-methyl-3-pyrrolin-2-one **77**. The system with deuterated ethyl group has been prepared according to the reactions in Scheme 12.²⁸ Addition of trimethylsilyl cyanide to ethyl 2-ethyl-3-oxobutyrate **32** afforded the cyano derivative **78**. Reduction of nitrile function with $\text{NiCl}_2/\text{NaBH}_4$ gave corresponding methylene amine derivative which is converted into the benzyl carboxamide derivative **79**. Debenzylation *via* reductive

cleavage and subsequent vacuum distillation gave the mixture of alcohol and its partial silylated product **80**. Reaction of **80** with sulfuric acid afforded 2-ethyl-3-methyl-3-pyrrolin-2-one **81**.



Scheme 11. Preparation of 3,4-disubstituted pyrrolinones **72**, **73** and **76** starting from ethyl 3-oxobutanoate **31**.

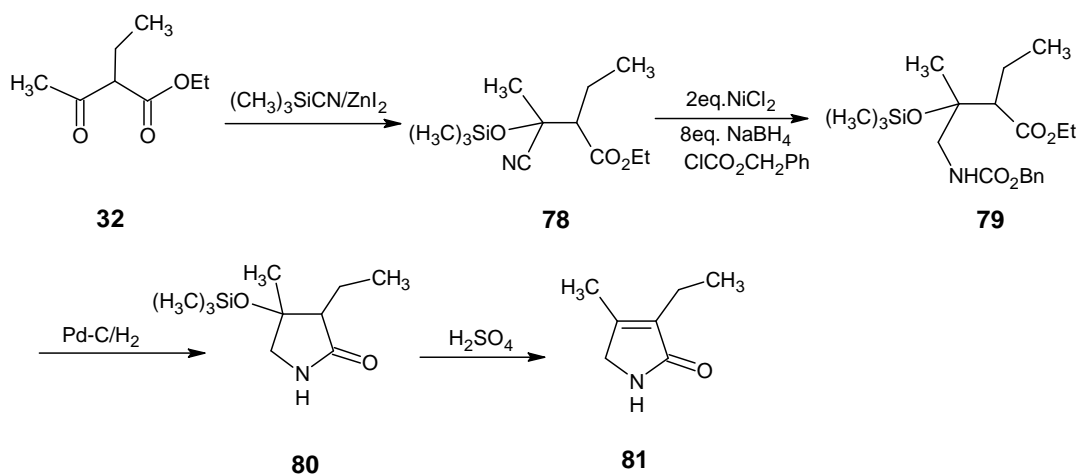

Scheme 12. Preparation of 3-ethyl-4-methyl-3-pyrrolinone **81** from ethyl 2-ethyl-3-oxobutanoate **32**.

The authors have prepared the pentadeutero isotopomer **81a**. In the Scheme 5 the reagent ethyl 2-ethyl-3-oxobutyrates **32** has been prepared from acetonitrile, ethyl bromoacetate and ethyl iodide. These starting materials are all commercially available in any isotope enriched form. Also the cyano function of trimethylsilyl cyanide can be isotopically enriched. It is clear that any isotopomer of **81** is accessible *via* Scheme 12.

2.1.10. Chlorophyll *a*

Woodward and co-workers reported the synthesis of chlorophyll **92** (Figure 10) in 1960.^{29,30} The pyrrole derivatives which have been used for the construction of chlorophyll *a* **92** are depicted in Figure 11. They are 3-(2-aminoethyl)-4-methylpyrrole **83** which forms the ring A, and 3,5-dimethyl-4-ethylpyrrole-2-carbaldehyde **85** which forms ring B. Ethyl 4-methylpyrrole-3-carboxylate **63** and 2-formyl-3-(2-ethoxycarbonyl)-4-methylpyrrole **91** are the bases of ring C and ring D, respectively. The preparation of **63** in all possible isotopically enriched forms has been discussed in section 2.1.7. The preparation of compounds **83**, **85** and **91** from building blocks such as **5** (Scheme 1) and **33** (Scheme 5) having access to any isotopically labeled form has also been discussed earlier.

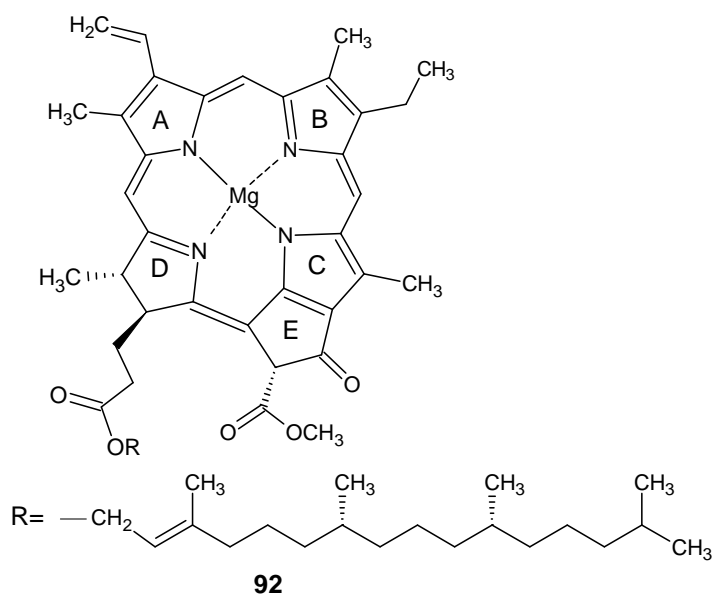

Figure 10. Structure of chlorophyll *a* **92**.

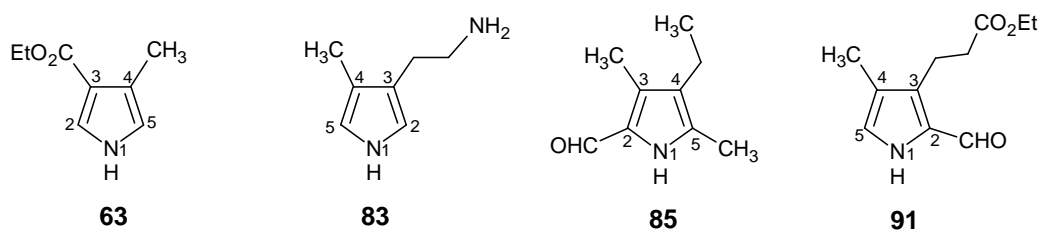
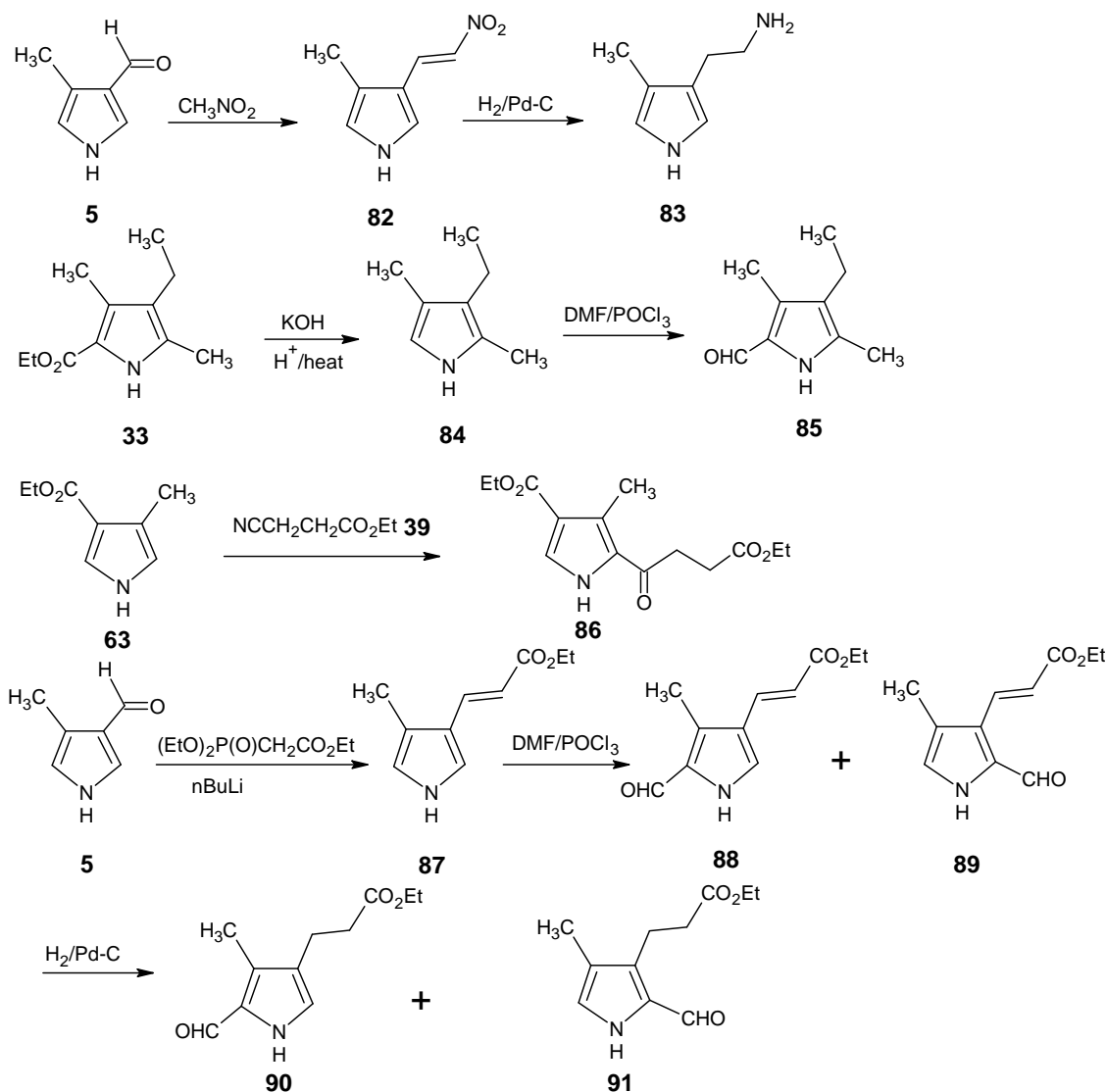

Figure 11. Structure and numbering of ethyl 4-methylpyrrole-3-carboxylate **63**, 3-(2-aminoethyl)-4-methylpyrrole **83**, 2-formyl-4-ethyl-3,5-dimethylpyrrole **85** and 2-formyl-3-(2-ethoxycarbonyl)-4-methylpyrrole **91**. Building blocks for the synthesis of chlorophyll *a*.



Scheme 13. Preparation of 3-(2-aminoethyl)-4-methylpyrrole **83**, 3,5-dimethyl-4-ethylpyrrole-2-carbaldehyde **85** and 2-formyl-3-(2-ethoxycarbonylethyl)-4-methylpyrrole **91**.

In Scheme 13, it is depicted how building blocks **83**, **85** and **91** can be prepared in all isotopically labeled forms. Condensation of 4-methylpyrrole-3-carbaldehyde **5** which is easily accessible in any isotopically labeled form (*via* Scheme 1) with nitromethane will form 4-methyl-3-(2-nitrovinyl)pyrrole **82**. This product can be converted into 3-(2-aminoethyl)-4-methylpyrrole **83** by double bond and nitro group reduction with hydrogen in the presence of platinum oxide as catalyst. 3,5-Dimethyl-4-ethylpyrrole-2-carbaldehyde **85** can be prepared from ethyl 3,5-dimethyl-4-ethylpyrrole-2-carboxylate **33** (which is available *via* Scheme 5) by saponification and decarboxylation of ethyl carboxylate group at position 2. 3,5-Dimethyl-4-ethylpyrrole **84** upon Vilsmeier Haack formylation gives pyrrole aldehyde **85**.

Ethyl 4-methylpyrrole-3-carboxylate **63** has to be converted into the succinyl derivative of pyrrole **86**. The substituent succinyl ester at position 2 is necessary to make ring E of chlorophyll macrocycle. Reaction of **63** with ethyl cyanopropionate is expected to give **86**. The preparation of **63** in all isotopically labeled forms has been discussed in section 2.1.7. (Figure 7) and preparation of ethyl cyanopropionate **39** in all isotopically labeled forms has been discussed in Scheme 7.

2-Formyl-3-(2-ethoxycarbonylethyl)-4-methylpyrrole **91** is prepared from 4-methylpyrrole-3-carbaldehyde **5** *via* Wittig reaction of the aldehyde function at position 3 with triethyl phosphonoacetate to give 3-(2-ethoxycarbonylvinyl)-4-methylpyrrole **87**. Vilsmeier reaction of product **87** with dimethyl formamide gave a mixture of aldehydes in the ratio of 2:1. In the product **88**, the aldehyde and methyl groups are at 2 and 3 positions, respectively, whereas in the product **89** the aldehyde and methyl groups are at 2 and 4 positions, respectively. They can easily be separated and a subsequent hydrogenation of **88** and **89** results in **90** and **91**, respectively. This means that all the building blocks used by Woodward *et al.* are now accessible in all possible isotopomeric forms. This leads to the conclusion that the access to all possible isotopomers of chlorophyll except the phytol ester group is possible *via* well established chemical reactions.

2.1.11. Protoporphyrin-IX, hemin and biliverdin

Smith and co-workers prepared stable isotope enriched protoporphyrins-IX **104a–g** *via* the reactions in Schemes 14–16.³¹ Acetylacetone **93** is reacted with methyl acrylate **68** to give methyl 4-acetyl-5-oxohexanoate **94**. The product **94** is treated with oximino derivative of *tert*-butyl acetoacetate to afford the *t*-butyl 3,5-dimethyl-4-(2-methoxycarbonylethyl)-pyrrole-2-carboxylate **95** *via* Knorr condensation. Lead tetracetate converted the α -methyl group of **95** into methylene acetate to give pyrrole **96**.

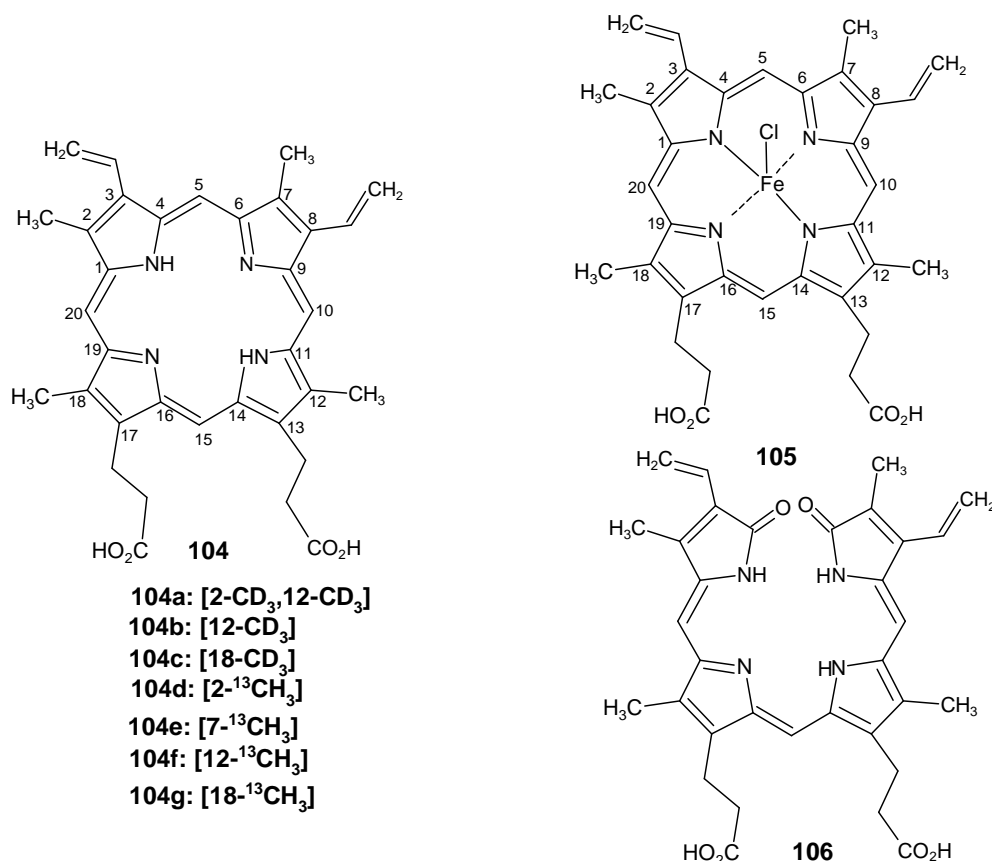
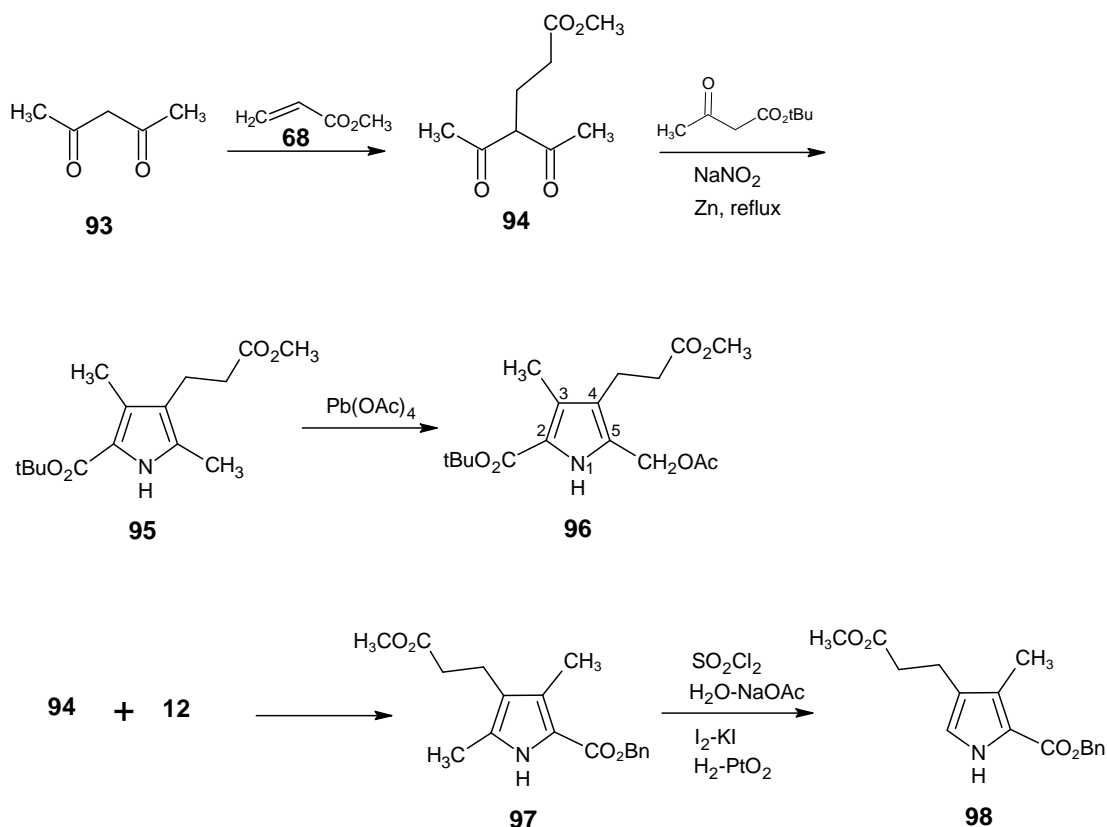

Figure 12. Structure of protoporphyrin-IX **104**, hemin **105** and biliverdin **106**.

Similar Knorr condensation of **94** with dibenzyl hydroxyiminomalonate **12** (in Scheme 3) afforded benzyl 3,5-dimethyl-4-(2-methoxycarbonylethyl)-pyrrole-2-carboxylate **97**. The α -free pyrrole **98**, required for the synthesis of pyrromethane **99**, is prepared by degradation of the α -methyl group of pyrrole **97**.

Degradation of the α -methyl group of pyrrole is achieved *via* chlorination and hydrolysis of carboxylic acid followed by iodative decarboxylation and hydrogenolysis of resulting iodopyrrole (Scheme 14). Pyrrole **96** is condensed with benzyl 3-methyl-4-(2-methoxycarbonyl)ethyl-pyrrole-2-carboxylate **98** to give the pyrromethane **99** (Scheme 15). Catalytic debenzoylation afforded pyrromethane carboxylic acid which is condensed with 2-formyl-4-(2-chloroethyl)-3,5-dimethyl pyrrole **100** in the presence of *p*-toluenesulfonic acid to yield tripyrrene hydrobromide **102**. Tripyrrene hydrobromide **102** condensed with pyrrole aldehyde **101** to give the tetrapyrrole system **103**. Further treatment of a,c-biladiene hydrobromide **103** with CuCl₂ in DMF afforded copper porphyrin. Removal of the copper ion followed by dehydrochlorination and saponification afforded protoporphyrin-IX **104**. Using the procedure illustrated in Scheme 15 with the appropriate reagents such as **93** and **68** with CD₃ and ¹³CH₃ substituents protoporphyrins **104a-g** have been prepared.



Scheme 14. Preparation of *t*-butyl 3-methyl-4-(2-methoxycarbonyl)ethyl-5-acetoxymethyl-pyrrole-2-carboxylate **96** and benzyl 3-methyl-4-(2-methoxycarbonyl)ethyl-pyrrole-2-carboxylate **98** starting from acetylacetone **93**.

Acetylacetone **93** and methyl acrylate **68** are available in any isotope enriched form.³² It is clear that pyrrole **96** is accessible in any isotopically enriched form. Pyrrole **98** can be obtained in any isotopically enriched form *via* following reactions (Scheme 16). Hydrogenation of **87** gives 3-(2-methoxycarbonyl)ethyl-4-methylpyrrole **107**. Friedel-Crafts acylation with trichloroacetyl chloride and subsequent treatment with benzyl alcohol/K₂CO₃ gives a mixture of two benzyl esters with pyrrole **98** as the prominent isomer.^{33,34} All isotopomers in 3-(2-methoxycarbonyl)ethyl-4-methylpyrrole **107** are accessible. The ester function will be lost during the final reactions and does not need to be isotopically enriched.

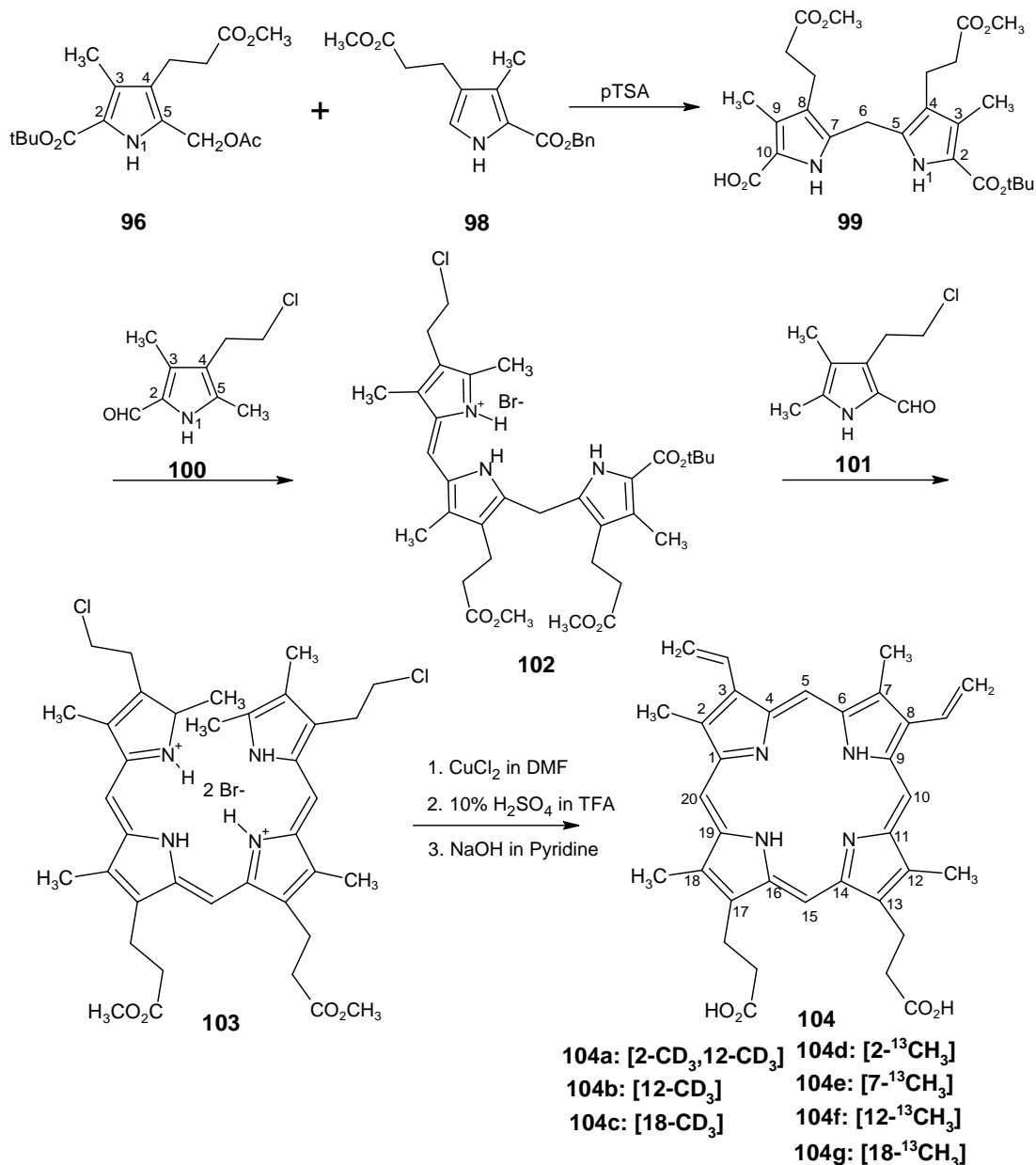

Scheme 15. Preparation of protoporphyrin-IX **104**.

2-Formyl-4-(2-chloroethyl)-3,5-dimethyl pyrrole **100** and 2-formyl-3-(2-chloroethyl)-4,5-dimethyl-pyrrole **101** can be obtained in any isotopically labeled form *via* following synthetic route. Alkylation of acetylacetone **93** with ethyl bromoacetate followed by Knorr condensation with dibenzyl hydroxyl-iminomalonate **12** (in Scheme 3) gives benzyl 3,5-dimethyl-4-ethoxycarbonylmethyl-pyrrole-2-carboxylate **108**. NaBH₄ reduction of the ester at position 4 gives benzyl 3,5-dimethyl-4-(2-hydroxyethyl)-pyrrole-2-carboxylate. The treatment with SOCl₂ in pyridine and catalytic debenzoylation gives pyrrole which is formylated *via* Vilsmeier procedure to obtain 2-formyl-4-(2-chloroethyl)-3,5-dimethyl pyrrole **100**.

Similarly, methyl 4-acyl-3-oxopentanoate **110** undergoes Knorr condensation to give benzyl 4,5-dimethyl-3-methoxycarbonylmethyl-pyrrole-2-carboxylate **111**. The starting methyl 4-acyl-3-oxopentanoate **110** is accessible *via* the alkylation of acetylacetone **93** with methyl iodide, followed by reaction with dimethyl carbonate in the presence of lithium hexamethyldisilazide.³⁵ Similar reactions as in

the transformations of **108** to **100** give 2-formyl-3-(2-chloroethoxy)-4,5-dimethyl pyrrole **101**. To prepare 2-formyl-3-(2-chloroethoxy)-4,5-dimethyl pyrrole **101** accessible in any isotope enriched form one can also start with 4-methylpyrrole-3-aldehyde **5** (in Scheme 1).¹² Reduction of pyrrole aldehyde **5** with NaBH₄ results alcohol which is further treated with SOCl₂ followed by NaCN to afford 3-cyanomethyl-4-methylpyrrole **112**. Vilsmeier Haack formylation of product **112** gives a mixture of the pyrrole aldehydes **113** and **114** which can be separated as in the Scheme 12 for the pyrrole aldehydes **88** and **89** or **90** and **91**.

Judicious application of LiAlH₄ and DIBAL reductions should convert the α -aldehyde function into α -methyl and nitrile function into alcohol function. The conversion of OH group into chloride group and formylation at position 2 result in pyrrole **101** and pyrrole **100**. Based on these building blocks, protoporphyrin-IX **104** is now accessible in any stable isotope enriched form.

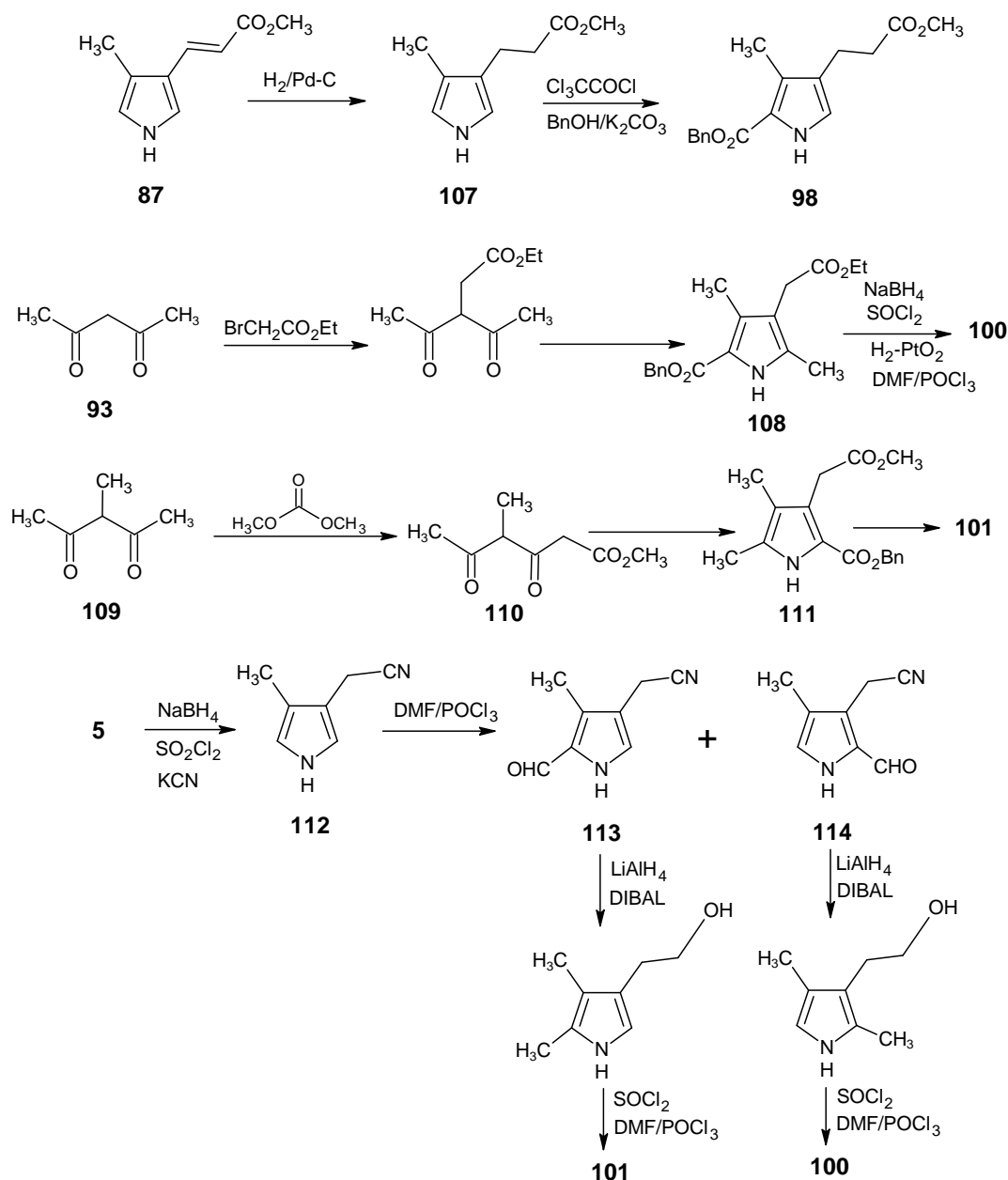

Scheme 16. Reactions to prepare pyrroles **98**, **100** and **101** in any isotopically labeled form.

Protoporphyrin-IX dimethyl ester upon treatment with FeCl₂ in methanol afforded haemin dimethyl ester which upon saponification gave haemin **105**. Haemin **105** has been used to reconstitute all haem proteins, which allows access to haemoproteins in all isotopically enriched forms. During haem catabolism, haemin **105** is converted into biliverdin **106** *via* oxidative cleavage at C-5 position with release of CO and Fe³⁺. This process can be effective in preparative yield *in vitro* with the required enzyme. In this way, biliverdin **106** is now accessible in any isotope enriched form. For structures **105** and **106**, see Figure 12.

2.1.12. (2*R*)-Phytochromobilin and (2*R/S*)-phytyocyanobilin

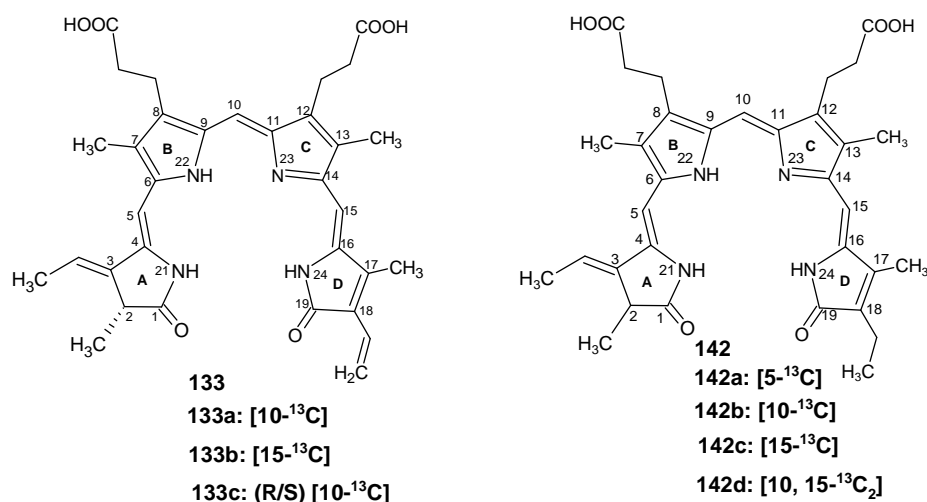
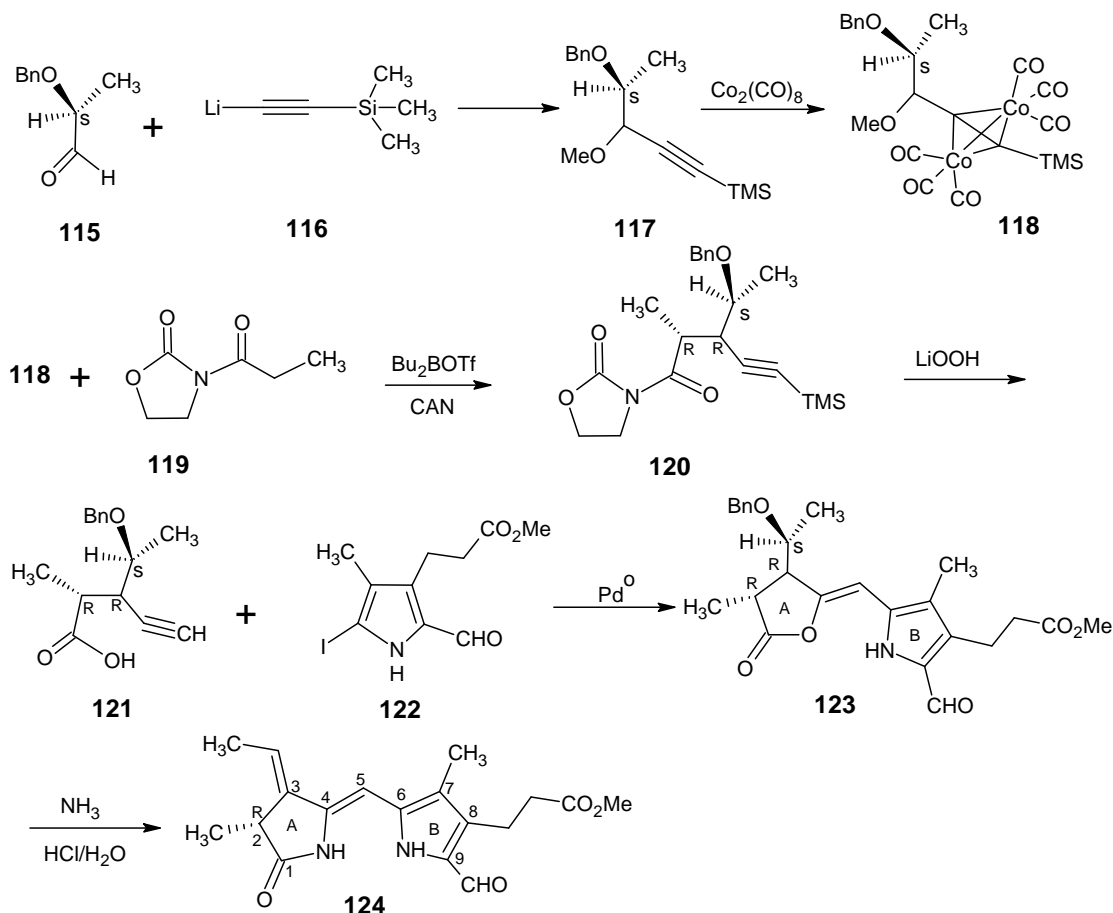

Figure 13. Structure and numbering of (2*R*)-phytochromobilin **133** and (2*R/S*)-phytyocyanobilin **142**.

Jacobi and co-workers have prepared [10-¹³C]- and [15-¹³C]-labeled phytochromobilin dimethyl esters **133a** and **133b** *via* reactions depicted in Schemes 17 and 18.³⁶ In Scheme 17 and Scheme 18 the pyrromethenones forming the A,B-ring precursor and C,D-ring precursor to phytochromobilin are depicted, respectively.

2.1.12.1. The synthesis of pyrromethenone **124** (A,B-ring segment of phytochromobilin)

Scheme 17 starts with 2-benzyloxypropanal **115**. Coupling with the anion of monotrimethylsilyl acetylene **116** and subsequent conversion of the alcohol function into a methyl ester gave 1-trimethylsilyl-3-methoxy-4-benzyloxy-pent-1-yne **117**. The acetylene function is protected into cobalt-complex structure **118** by treating it with Co₂(CO)₈. Coupling of product **118** with boron enolate of oxazolidinone **119** followed by ceric ammonium nitrate treatment afforded **120**. Oxidation with hydrogen peroxide in the presence of LiOH.H₂O yielded 3-(1-benzyloxyethyl)-2-methylpent-4-ynoic acid **121**. Molecule **121** upon palladium (0) mediated coupling with 2-iodo-3-methyl 4(2-methoxycarbonyl)ethyl-pyrrole-5-aldehyde **122** afforded product **123**. The lactone function in the ring A of **123** is converted into a lactam ring A. By treatment of **123** with ammonia, it is converted into the aminoalcohol in which the water molecule is removed to create the bridged double bond and simultaneously the benzyloxy function is removed by the treatment of this product into a two phase system (consisting of CHCl₃ and HCl) to form the product **124** (A,B-ring component of phytochromobilin).



Scheme 17. Preparation of pyromethenone **124** (A,B-ring segment of (2*R*)-phytochromobilin) starting from 2-benzyloxypropanal **115**.

The pyrrole aldehyde **122** is 5-iodo derivative corresponding to pyrrole aldehyde **91** which is accessible in any isotopically labeled form. Iodination of the pyrrole **91** having free α -position gives product **122**. A building block **119** is derived from propionic acid which is available in any isotope enriched form. Also **115** is easily accessible in any isotope labeled form. The Scheme can be adjusted such that **121** will be accessible in any isotope labeled form. This means that the synthetic Schemes can be adjusted to give access to any isotopically enriched product **124**.

2.1.12.2. The synthesis of pyromethenone **132** (C,D-ring segment of phytochromobilin)

For the C,D-ring precursor of tetrapyrrole, Scheme 18 starts with butyrolactone **125**. Ring opening of **125** occurred by reaction with *p*-chlorophenylselenide anion to give 1-[4-(4-chlorophenylselenyl)] butyric acid.³⁷ This product is converted into the corresponding acid chloride **126** by treatment with oxalyl chloride and further treated with 1-amino-2,2-dimethoxypropane hydrochloride **127** to yield amide **128**. The NH of amide function is protected into the Boc function by treatment with (Boc)₂O in the presence of Et₃N and DMAP. This product in the presence of KO^t-Bu afforded pyrrolinone **129** which is subsequently converted into the 1-Boc-2-trimethylsilyloxy pyrrole **130** by reacting with TBSOTf. Product **130** was treated with pyrrole aldehyde **131** in the presence of TiCl₄ to form a hydroxyl methyl bridged dipyrrole derivative that is hydroxypyromethane. Treatment with trifluoroacetic acid removed the water and the BOC protecting group to give **132** which forms the C,D-ring segment of phytochromobilin.

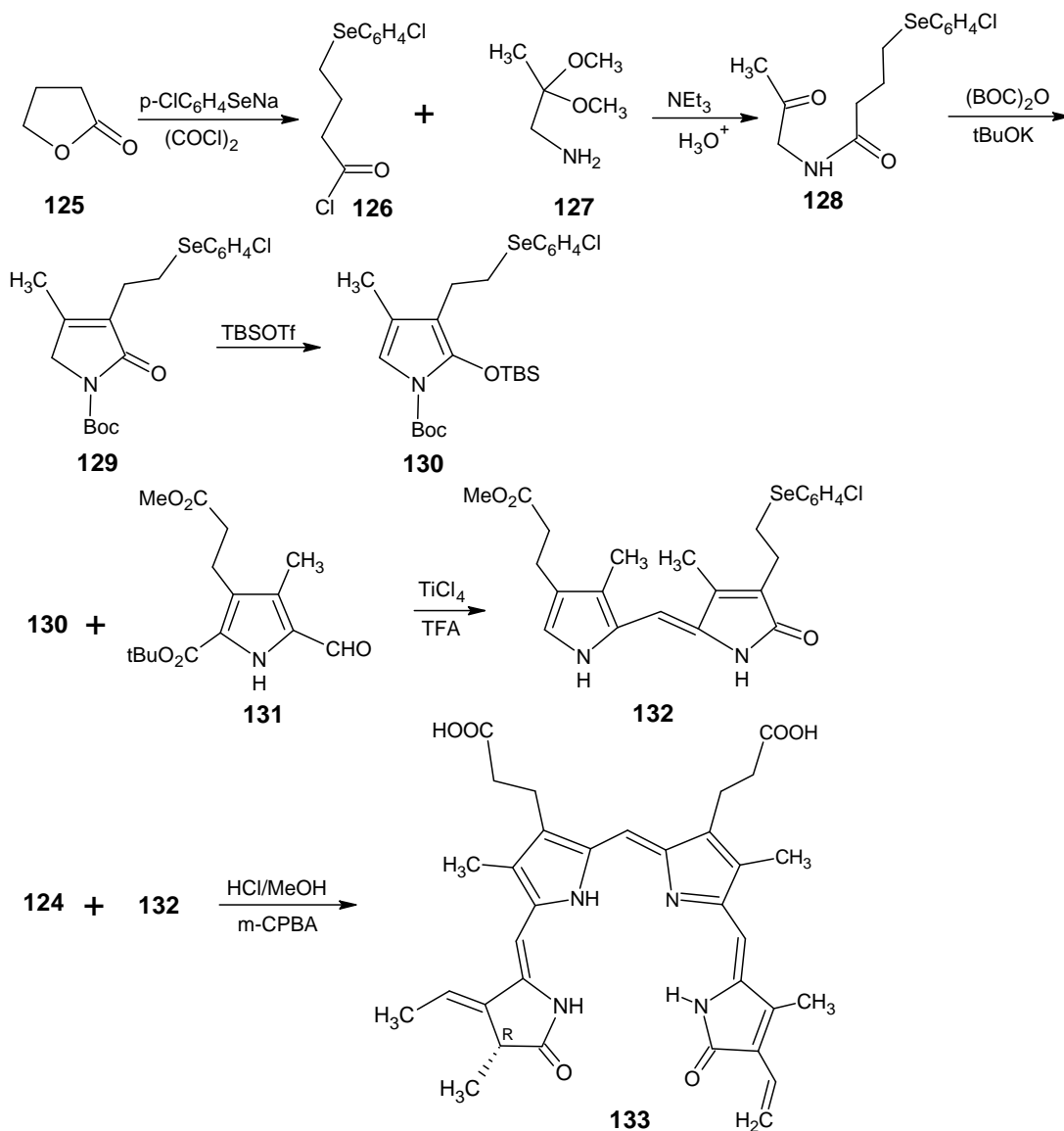

Scheme 18. Synthesis of pyromethenone **132** (C,D-part of phytychromobilin) starting from butyrolactone **125** and final assembly to (2*R*)-phytychromobilin **133**.

2.1.12.3. Coupling of pyromethenones **124** and **132** to form (2*R*)-phytychromobilin

A final acid catalyzed coupling between **124** and **132** afforded the structure of (2*R*)-phytychromobilin with the ring D having vinyl group protection as seleno-*p*-chlorophenylfunction. Oxidation with *m*-chloroperbenzoic acid resulted in (2*R*)-phytychromobilin **133** (Figure 13). Butyrolactone **125** and aminoacetone dimethylacetal **127** are accessible in any isotope labeled form. It is to be expected that instead of *t*-butyl 5-formyl-3-(2-methoxycarbonylethyl)-4-methylpyrrole-2-carboxylate **131** building block 2-formyl-4-(2-ethoxycarbonylethyl)-3-methylpyrrole **90** in Scheme 12 which is accessible in any isotope labeled form can be used. This means that (2*R*)-phytychromobilin **133** is accessible in any isotope labeled form.

Gaertner and co-workers have reported the synthesis of (2*R/S*)-phycocyanobilin **142a–d** and [10-¹³C]-(2*R/S*)-phytychromobilin **133c** (Figure 13).³⁸ They used Barton and Zard's method³⁹ to synthesize the pyrrole that forms ring B. In Scheme 19 the synthesis is started with methyl 5-nitrohex-4-enoate **134**. A base catalysed condensation with *t*-butyl isocynoacetate **135** afforded *t*-butyl 3-(2-methoxycarbonylethyl)-4-

methylpyrrole-2-carboxylate **136**. Treatment of pyrrole **136** with benzyl iodoacetate and subsequent chlorination with SO_2Cl_2 gave the chloroacetyl derivative **137** which is treated with triphenyl phosphine to give the Wittig reagent **138**.

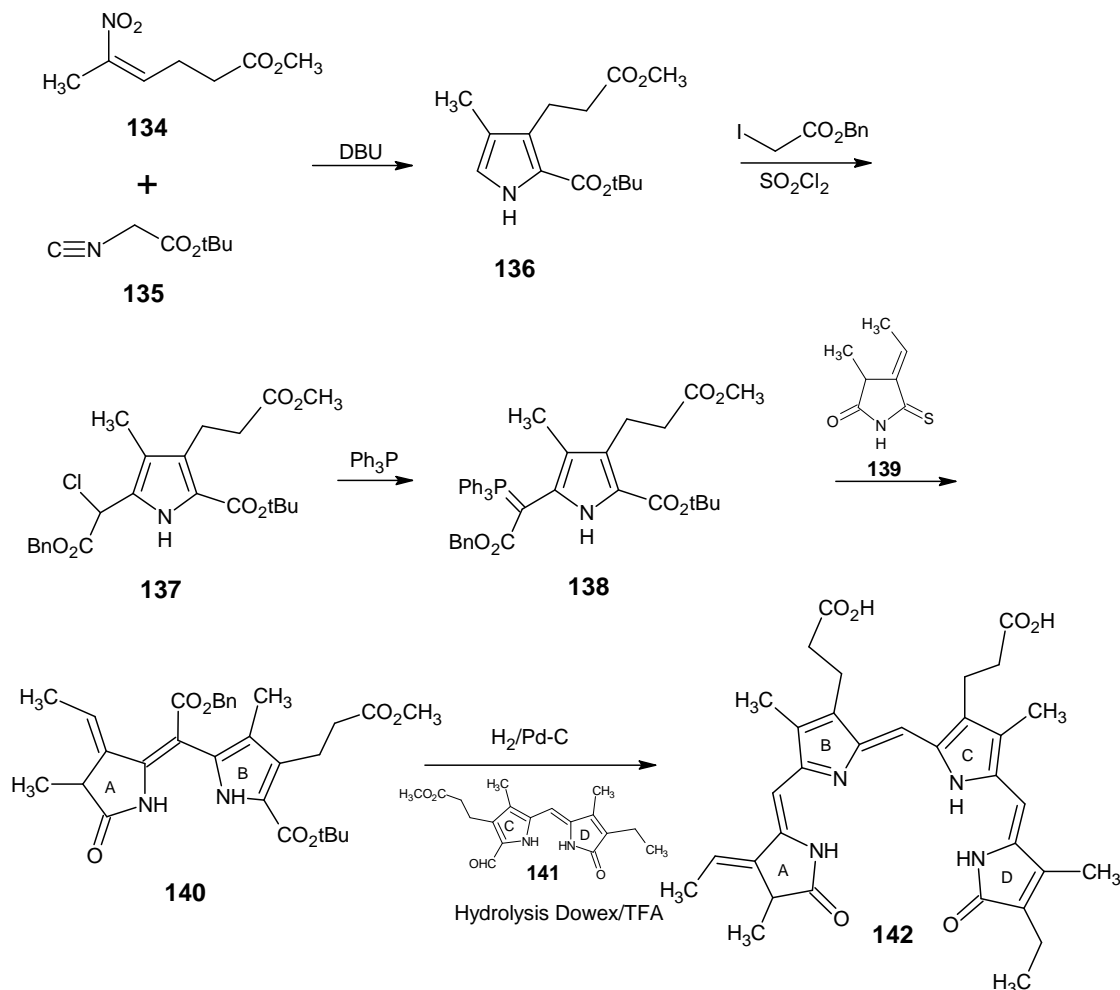

Scheme 19. Preparation of (2*R/S*)-phycocyanobilin **142**.

This product upon Wittig coupling with the monothiosuccinimide **139** afforded pyrromethenone **140** (A,B-ring part of bilin). The product **140** is hydrogenated with palladium on charcoal to remove the benzyl ester function followed by coupling with pyrromethenone **141** (C,D-ring segment) to obtain phycocyanobilin dimethyl ester. The residue has been subsequently treated over Dowex with trifluoroacetic acid and water to yield (2*R/S*)-phycocyanobilin **142**. The authors have reported the synthesis of [5- ^{13}C]-, [10- ^{13}C]-, [15- ^{13}C]- and [10,15- $^{13}\text{C}_2$]-phycocyanobilin **142a**, **142b**, **142c** and **142d**, respectively. *t*-Butyl 3-(2-ethoxycarbonyl)ethyl-4-methylpyrrole-2-carboxylate which is ethyl ester derivative of **136** can be prepared by introduction of the ester function at position 2 in 4-(2-ethoxycarbonylvinyl)-3-methylpyrrole **87** (Scheme 13). Product **87** is accessible in any isotopically enriched form. Iodoacetic acid ester is available in any isotopically labeled form,¹² which introduces ^{13}C in the methine position at 5 in final phycocyanobilin.

The building block **139** has been prepared (Gossauer and co-workers) *via* alkylation of diethyl cyanomethylphosphonate with methyl 2-bromopropionate.⁴⁰ A subsequent Wittig reaction with acetaldehyde gave basic carbon and nitrogen containing system. The product is selectively hydrolyzed to the corresponding carboxylic acid and subsequently transformed into chloride and amide. The latter is cyclized

in the presence of sodium ethoxide to get succinimidine which on treatment with H₂S in pyridine afforded monothiosuccinimide **139**. This means that monothiosuccinimide **139** is accessible in any isotopically enriched form. Pyrromethenone **141**⁴⁰ (C,D-ring segment) has been prepared by Gossauer *via* coupling of 3-ethyl-4-methyl-3-pyrrolin-2-one **81** with 3,4-disubstituted pyrrole aldehyde to make C,D-ring part of phycocyanobilin **141**. The ring D is 3-ethyl-4-methyl-3-pyrrolin-2-one **81** and it can be prepared in all isotopomeric forms *via* Scheme 12.

Pyrromethenone **141** (C,D-ring segment) can be easily obtained *via* condensation of pyrrole aldehyde **90** (Scheme 13) and 3-ethyl-4-methyl-3-pyrrolin-2-one **81** (Scheme 12) and subsequent formylation. This means that pyrromethenone **141** is accessible in any isotopically enriched form. The final coupling of pyrromethenone **140** (A,B-ring part) with pyrromethenone **141** (C,D-ring part) afforded (2*R/S*)-phycocyanobilin **142** (Figure 13) which is also accessible in any isotopically enriched form.

Pyrromethenone **141** (C,D-ring component) has been obtained in two steps from commercial biliverdin-IX α diethyl ester⁴¹ by treating with thiobarbituric acid in ethyl acetate which is formylated with trimethylorthoformate [¹³C-formyl] in TFA and finally coupled with pyrromethenone (A,B-ring segment) to obtain [10-¹³C]-(2*R/S*)-phytychromobilin **133c**.

2.1.13. Bilirubin and its analogs

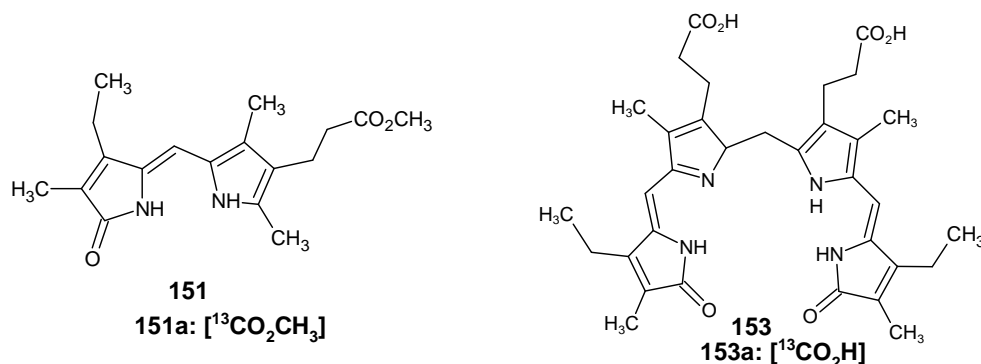
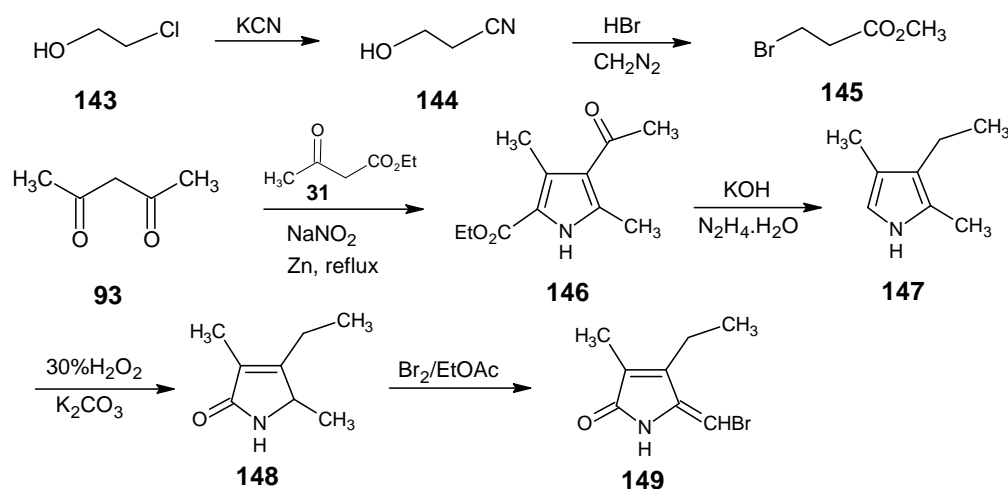

Figure 14. Structure and numbering of methyl xanthobilirubinate **151** and mesobilirubin-XIII α **153**.



Scheme 20. Preparation of 5-bromomethylene-4-ethyl-3-methyl-3-pyrrolin-2-one **149** by oxidation of 2,4-dimethyl-3-ethylpyrrole **147**.

Lightner and co-workers have prepared bilirubin and its analog such as [$^{13}\text{CO}_2\text{H}$]-labeled mesobilirubin-XIII α (Figure 14) *via* Schemes 20 and 21.⁴² The synthetic Scheme 20 starts with methyl 3-bromopropionate **145** which is obtained from 2-chloroethanol **143**.

Alkylation of acetylacetone **93** with methyl bromopropionate **145** afforded 4-acetyl-5-oxohexanoate **94** which underwent Knorr condensation with ethyl 3-oxobutyrates to give ethyl 3,5-dimethyl-4-(2-methoxycarbonyl-ethyl)-pyrrole carboxylate **150** (Scheme 21). After saponification of **150**, the corresponding diacid is obtained which is coupled with 5-bromoethylenepyrrolinone **149** to afford methyl xanthobilirubinate **151**. Oxidative coupling of **151** using *p*-chloranil afforded mesobiliverdin-XIII α dimethyl ester **152**. Reduction with NaBH_4 and saponification afforded mesobilirubin-XIII α -bis- $[\text{CO}_2\text{H}]$ **153**.

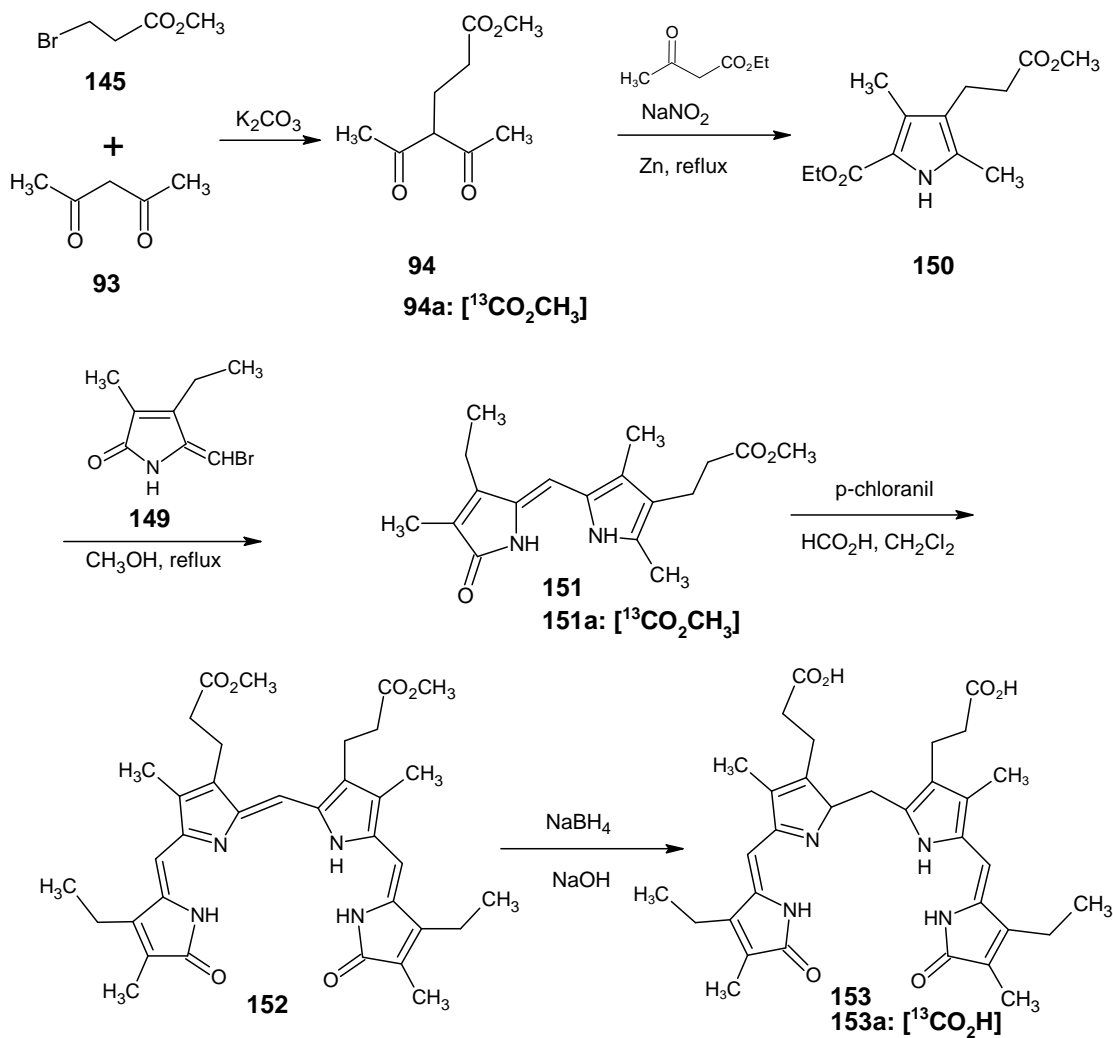

Scheme 21. Preparation of mesobilirubin-XIII α **153** starting from methyl 4-acetyl-5-oxohexanoate **94**.

Acetylacetone **93** and ethyl 3-oxobutyrates **31** are all accessible in any isotopically labeled form. This means that *via* Schemes 20 and 21 bilirubin analog **153** is accessible in any isotope enriched form. In Scheme 20, bromomethylenepyrrolinone **149** is obtained from 2,4-dimethyl-3-ethylpyrrole **147** *via* H_2O_2 oxidation and subsequent bromination in ethyl acetate. All the reagents used in this Scheme are accessible in any isotopically enriched form.

3. Conclusion

This paper is written with great indebtedness to investigators who have been involved in the synthesis of pyrroles, protoporphyrins, chlorophyll *a* etc and especially to those investigators who have pioneered the stable isotope labeled systems in this field. It is clear that *via* the synthetic procedures discussed in this paper, all the important biological systems mentioned here are now accessible in any stable ^{13}C , ^{15}N isotope enriched form. We dedicated this paper to the future investigators who will prepare the now accessible isotopomers to obtain the structural and functional information without perturbation at the atomic level with the ultimate resolution of heme proteins and related protein systems in the life processes. We feel that this functional information will be useful to fully understand the essential life processes in question.

Acknowledgements

This work was supported by grants from Volkswagen Stiftung (I/79979). We are very thankful to Prof. Dr. W. Gaertner (Max Planck-Institute for Bioinorganic Chemistry, Muelheim, Germany) and Dr. J. Matysik (Leiden Institute of Chemistry) for their valuable suggestions.

References

1. Stryer, L. *Biochemistry*, 4th ed.; Freeman, W. H. and co.: New York, 1995.
2. Shemin, D.; Rittenberg, D. *J. Biol. Chem.* **1946**, *166*, 621–625.
3. Shemin, D.; Rittenberg, D. *J. Biol. Chem.* **1946**, *166*, 627–636.
4. Battersby, A. R.; Hunt, E.; McDonald, E.; Paine III, J. B.; Saunders, J. J. *Chem. Soc., Perkin Trans. 1* **1976**, 1008–1018.
5. Scott, A. I.; Burton, G.; Fagerness, P. E. *J. Chem. Soc., Chem Commun.* **1979**, 199–202.
6. La Mar, G. N.; Burns, P. D.; Jackson, J. T.; Smith, K. M.; Langry, K. C.; Strittmatter, P. *J. Biol. Chem.* **1981**, *256*, 6075–6079.
7. Roy, E.; Rohmer, T.; Gast, P.; Jeschke, G.; Alia, A.; Matysik, J. *Biochemistry* **2008**, *47*, 4629–4635.
8. Siebert, F.; Hildebrandt, P. *Vibrational Spectroscopy in Life Science*; Wiley-VCH: Weinheim, 2008.
9. Gruia, F.; Kubo, M.; Ye, X.; Ionascu, D.; Lu, C.; Poole, R. K.; Yeh, S.; Champion, P. M. *J. Am. Chem. Soc.* **2008**, *130*, 5231–5244.
10. Leng, W.; Kelley, A. M. *J. Phys Chem. A* **2008**, *112*, 5925–5929.
11. Creemers, A. F. L.; Lugtenburg, J. *J. Am. Chem. Soc.* **2002**, *124*, 6324–6334.
12. Dawadi, P. B. S.; Lugtenburg, J. *Eur. J. Org. Chem.* **2008**, 2288–2292.
13. Van den Berg, E. M. M.; Richardson, E. E.; Lugtenburg, J.; Jenneskens, L. W. *Synth. Commun.* **1987**, *17*, 1189–1198.
14. Kuerti, L.; Czako, B. *Strategic Applications of the Named Reactions*; Academic Press Elsevier, 2005.
15. Battersby, A. R.; Fookes, C. J. R.; Meegan, M. J.; McDonald, E.; Wurziger, H. K. W. *J. Chem. Soc., Perkin Trans. 1* **1981**, 2786–2799.
16. Dawadi, P. B. S.; Lugtenburg, J. *Eur. J. Org. Chem.* **2003**, 4654–4663.
17. Hu, S.; Mukharjee, A.; Piffat, C.; Mak, R. S. W.; Li, X. Y.; Spiro, T. G. *Biospectroscopy* **1995**, *1*, 395–412.
18. Battersby, A. R.; Hodgson, G. L.; Ihara, M.; McDonald, E.; Saunders, J. J. *Chem. Soc., Perkin Trans. 1* **1973**, 2923–2935.
19. Buldain, G.; Valasinas, A. *J. Labelled Comp. and Radiopharm.* **1980**, *19*, 1–5.
20. Battersby, A. R.; Beck, J. F.; Gibson, K. M.; Hodgson, G. L.; Markwell, R. E.; McDonald, E.; Moron, J. J. *Chem. Soc., Perkin Trans. 1* **1981**, 2771–2778.
21. Soldermann, C. P.; Vallinayagam, R.; Tzouros, M.; Neier, R. *J. Org. Chem.* **2008**, *73*, 764–767.
22. Iida, K.; Ohtaka, K.; Komatsu, T.; Makino, T.; Kajiwara, M. *J. Labelled Comp. and Radiopharm.* **2008**, *51*, 167–169.
23. Chiba, S.; Wang, Y. F.; Lapointe, G.; Narasaka, K. *Org. Lett.* **2008**, *10*, 313–316.

24. Van Leusen, A. M.; Siderius, H.; Hoogenboom, B. E.; van Leusen, D. *Tetrahedron Lett.* **1972**, *52*, 5337–5340.
25. Cappon, J. J.; Witters, K. D.; Baart, J.; Verdegem, P. J. E.; Hoek, A. C.; Luiten, R. J. H.; Raap, J.; Lugtenburg, J. *Recl. Trav. Chim. Pays-Bas* **1994**, *113*, 318–328.
26. Dawadi, P. B. S.; Lugtenburg, J. *Eur. J. Org. Chem.* **2007**, 1294–1300.
27. Plieninger, H.; Kurze, J. *Liebigs Ann. Chem.* **1964**, *680*, 60–69.
28. Burton, A. J.; Wadsworth, A. H. *J. Labelled Comp. and Radiopharm.* **2007**, *50*, 273–276.
29. Woodward, R. B.; Ayer, W. A.; Beaton, J. M.; Bickelhaupt, F.; Bonnett, R.; Buchschacher, P.; Closs, G. L.; Dutler, H.; Hannah, J.; Hauck, F. P.; Ito, S.; Langemann, A.; Le Gaff, E.; Leimgruber, W.; Lwowski, W.; Sauer, J.; Valenta, Z.; Volz, H. *J. Am. Chem. Soc.* **1960**, *82*, 3800–3802.
30. Woodward, R. B.; Ayer, W. A.; Beaton, J. M.; Bickelhaupt, F.; Bonnett, R.; Buchschacher, P.; Closs, G. L.; Dutler, H.; Hannah, J.; Hauck, F. P.; Ito, S.; Langemann, A.; Le Gaff, E.; Leimgruber, W.; Lwowski, W.; Sauer, J.; Valenta, Z.; Volz, H. *Tetrahedron* **1990**, *46*, 7599–7659.
31. Smith, K. M.; Pandey, R. K. *J. Heterocyclic Chem.* **1983**, *20*, 1383–1388.
32. Werkhoven, T. M.; van Nispen, R.; Lugtenburg, J. *Eur. J. Org. Chem.* **1999**, 2909–2914.
33. Harbuck, J. W.; Rapoport, H. *J. Org. Chem.* **1972**, *37*, 3618–3622.
34. Treibs, A.; Kreuzer, F. H. *Leibigs Ann. Chem.* **1969**, *721*, 105–115.
35. Barrett, A. G. M.; Morris, T. M. *J. Chem. Soc., Perkin Trans. 1* **1980**, 2272–2277.
36. Jacobi, P.; DeSimone, R. W.; Gosh, I.; Guo, J.; Leung, S. H.; Pippin, D. *J. Org. Chem.* **2000**, *65*, 8478–8489.
37. Jacobi, P.; Pippin, D. *Org. Lett.* **2000**, *65*, 827–830.
38. Makhynya, Y.; Hussain, Z.; Bauschlicher, T.; Schwinte, P.; Siebert, F.; Gaertner, W. *Eur. J. Org. Chem.* **2007**, 1287–1293.
39. Barton, D. H. R.; Zard, S. *J. Chem. Soc., Chem. Commun.* **1985**, 1098–1100.
40. Gossauer, A.; Hinze, R. *J. Org. Chem.* **1978**, *43*, 283–285.
41. Lindner, I.; Knipp, B.; Braslavsky, S. E.; Gaertner, W.; Schaffner, K. *Angew. Chemie Int. Ed.* **1998**, *37*, 1843–1846.
42. Nogales, D. F.; Lightner, D. A. *J. Labelled Comp. and Radiopharm.* **1994**, *34*, 453–462.

α -ALKYLIDENE- γ -LACTONES AND LACTAMS VIA RADICAL- AND TRANSITION METAL-MEDIATED CYCLIZATIONS

Laurence Feray and Michèle P. Bertrand*

*Laboratoire de Chimie Moléculaire Organique, UMR 6264: LCP,
Universités d'Aix-Marseille 1,2,3-CNRS, Faculté des Sciences et Techniques de Saint-Jérôme,
case 562, Avenue Escadrille Normandie-Niemen, F-13397 Marseille cedex 20, France
(e-mail: michele.bertrand@univ-cezanne.fr)*

Abstract. *Radical- and transition metal-mediated cyclizations display a large variety of similar or complementary approaches for the construction of α -alkylidene- γ -lactones and γ -lactams. These compounds that possess a range of biological activities are important targets and have stimulated the creativity of most synthetic chemists. The aim of this review is not to be exhaustive, but rather to give a comprehensive picture of the most frequently encountered methodologies.*

Contents

1. Introduction
2. Radical cyclizations
 - 2.1. Intramolecular addition of alkoxy carbonyl radicals to conjugated alkyne
 - 2.2. Enyne cyclization
 - 2.2.1. Tandem addition of nucleophilic radicals to activated triple bond/5-exo ring closure
 - 2.2.2. Tandem addition of electrophilic radicals to double bond/5-exo ring closure onto conjugated alkyne
 - 2.3. Iodine atom transfer-mediated cyclization onto conjugated alkyne
 - 2.4. Two-step strategies involving 5-exo-dig cyclizations followed by oxidation of resulting 3-alkylidene-tetrahydrofurans
3. Transition metal-mediated cyclizations
 - 3.1. Cyclization of alkoxy carbonyl- and carbamoyl- metal complexes onto triple bond
 - 3.2. Enyne cyclization
 - 3.2.1. Palladium-catalyzed reactions
 - 3.2.1.1. Halopalladation
 - 3.2.1.2. Acetoxypalladation
 - 3.2.1.3. Carbopalladation
 - 3.2.1.4. Tandem cyclization/Suzuki coupling
 - 3.2.2. Rhodium(I)-catalyzed reactions
 - 3.2.2.1. Cycloisomerization of 1,6-enynes
 - 3.2.2.2. Reductive cycloisomerization of 1,6-enynes and acetylenic aldehydes
 - 3.2.3. Alkenylative cyclization promoted by ruthenium catalysts
 - 3.3. Two-step procedures involving Pd(0)-mediated cyclization followed by oxidation

3.4. Miscellaneous methodologies

3.4.1. Cycloalkenylation of tungsten-alkynyl amines

3.4.2. Cyclization involving Pd(0) as the leaving group

3.4.2.1. Pd-catalyzed heteroannulation of 1,3-dienes

3.4.2.2. Pd-catalyzed carbonylation of 3-iodohomoallylic alcohols

3.4.3. Ti(II)-mediated cyclization of homopropargylic carbonates

3.4.4. [2+2+1] Cycloaddition leading to bicyclic α -alkylidene- γ -lactones and lactams

4. Conclusion

1. Introduction

α -Methylene and more generally α -alkylidene- γ -butyrolactones and γ -butyrolactams are structural entities encountered in many natural products possessing a range of biological activities.¹ Cytotoxic, antitumor, and anti-inflammatory activities have frequently been reported for these two classes of compounds. These properties are ascribed to the specific reactivity of the α,β -unsaturated carbonyl group which acts as Michael acceptor when it reacts with biological nucleophiles.² Compared to the corresponding lactones, lactams exhibit moderate toxicity.

The purpose of this review is to summarize the different strategies leading to these heterocyclic compounds based on either radical- or transition metal-mediated cyclizations as key step. A parallel between the two classes of reactions will be tentatively established according to the selected framework. Classical lactone or lactam ring closure *via* nucleophilic substitution at carboxylic derivatives are excluded from the content except those where Pd(0) is the leaving group. It is to be underlined that Horner-Wadsworth-Emmons α -olefination, through the reaction of appropriate preformed phosphorylated lactones and lactams with aldehydes, constitutes a valuable strategy. This methodology has already been the subject of an excellent review in this book series.³

2. Radical cyclizations

Radical cyclizations are useful tools for ring construction and they are well known to be particularly performant for 5-membered ring closure.^{4,5}

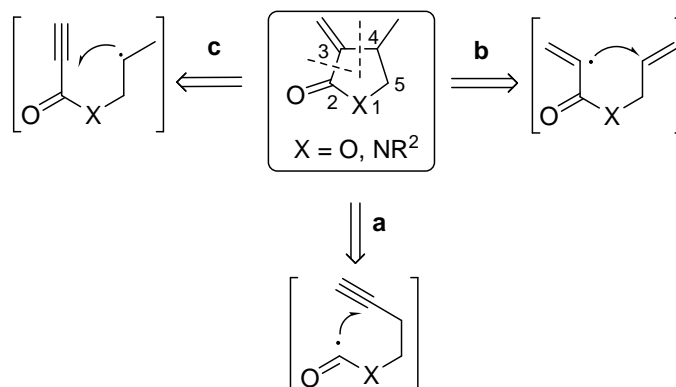

Scheme 1

In the case of α -alkylidene- γ -lactones and γ -lactams targets, two types of retrosynthetic disconnection can be distinguished depending on whether C2-C3 or C3-C4 bond is formed in the key step. The former strategy consists in the cyclization of carbamoyl or alkoxy carbonyl radicals onto triple bonds (**a**), the latter may involve either the cyclization of a vinyl radical in position α relative to the carbonyl group (**b**), or the cyclization of an alkyl radical generated at C4 onto an activated triple bond (**c**) (Scheme 1).

2.1. Intramolecular addition of alkoxy carbonyl radicals to conjugated alkyne

This strategy was developed by Bachi to prepare α -alkylidene- γ -lactones.⁶ The key intermediate, *i.e.* the alkoxy carbonyl radical, was first generated from the corresponding chloride. Far higher yields in cyclization product were obtained starting from the corresponding selenocarbonates (Scheme 2).

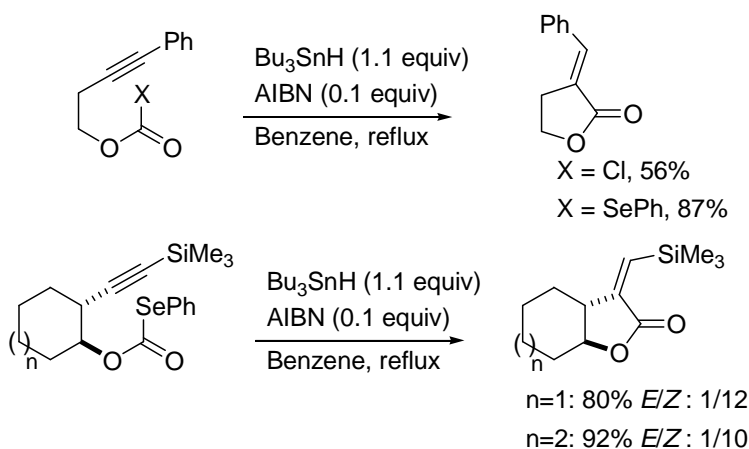

Scheme 2

The substrates are readily available from homopropargyl alcohols, themselves obtained from treatment of oxiranes with lithium acetylides in the presence of boron trifluoride etherate. The reactions were carried out by slowly adding tributyltin hydride and AIBN to a boiling solution of substrate in benzene. Owing to the low inversion barrier of vinyl radicals,⁷ the stereoselectivity is mainly determined by steric hindrance to the approach of the hydrogen atom donor in the last propagation step (Scheme 3).

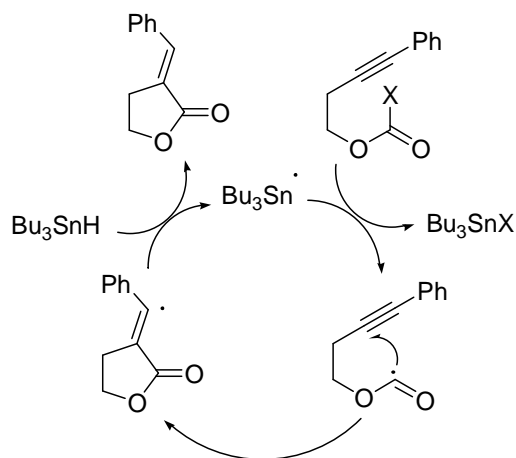

Scheme 3

Surprisingly the cyclization of carbamoyl radical onto triple bond was not applied to the synthesis of α -alkylidene- γ -lactams. It can be noted however, that 4-exo cyclization of carbamoyl radical generated from the corresponding cobalt(II)-salophen complex onto a suitably located double bond led to the unsaturated β -lactam through β -elimination of the final alkyl cobalt(III) azetidinone (Scheme 4).⁸

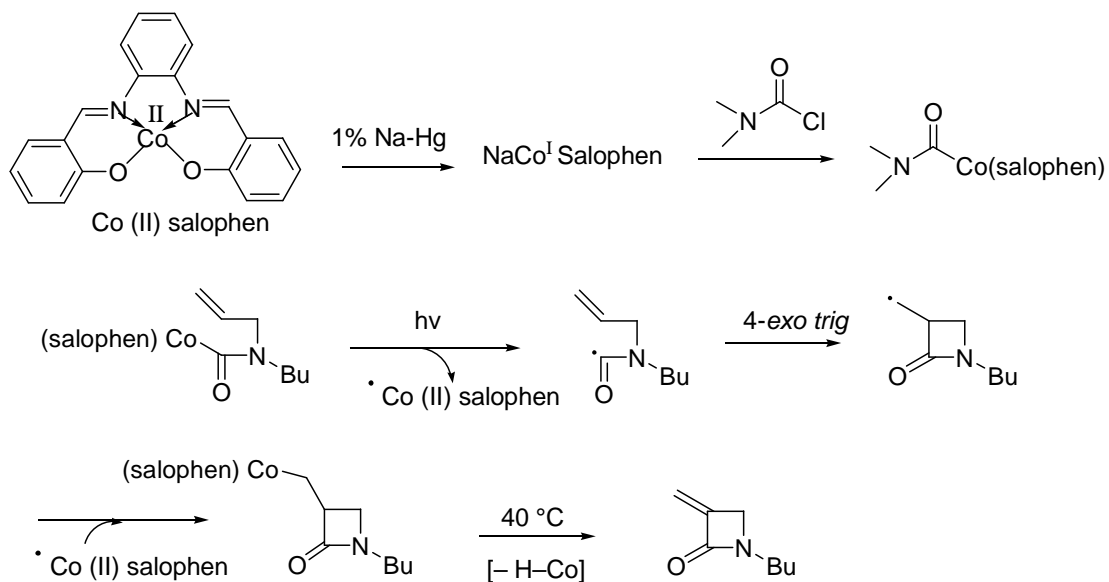

2.2. Enyne cyclization

Depending on the polar character of the attacking radical, the procedure that involves intermolecular radical addition followed by radical ring closure may either start with radical addition to the enyne moiety (nucleophilic radicals) or radical addition to the non conjugated double bond (electrophilic radicals).

2.2.1. Tandem addition of nucleophilic radicals to activated triple bond/5-exo ring closure

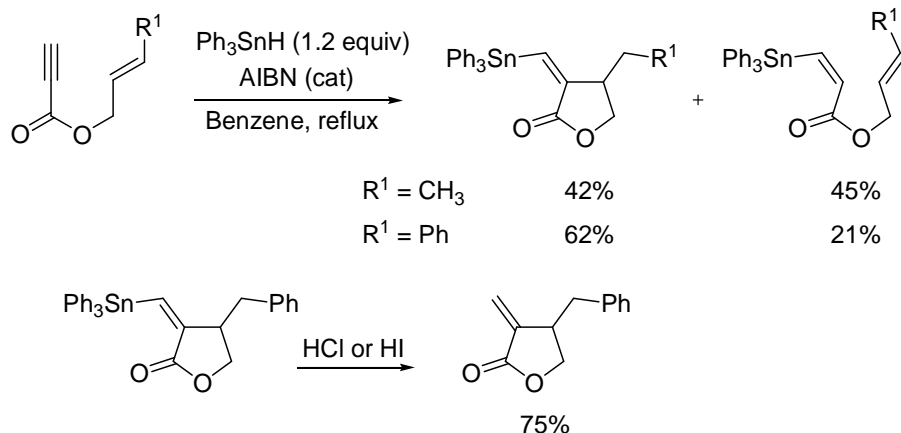

Lee and co-workers have investigated the cyclization of allyl propynoates.⁹ The addition of tributyl- and triphenyl-stannane were achieved at 80 °C in benzene solution, and it led to α -(stannyl)methylene- γ -butyrolactones (Scheme 5). The latter were easily converted into the corresponding α -methylene- γ -butyrolactones by destannylation upon treatment with HCl or HI.

The main difficulty resides in the competition between 5-exo ring closure of the intermediate vinyl radical and hydrogen atom transfer from tin hydride which is very fast ($k_H=7.5 \times 10^8 \text{ M}^{-1} \text{ s}^{-1}$ at 25 °C)¹⁰ (Scheme 6). The ratio of cyclized/uncyclized adducts did not change much upon very high dilution (syringe pump addition or *in situ* generation of the stannane *via* reduction of the corresponding stannyl chloride with sodium cyanoborohydride).

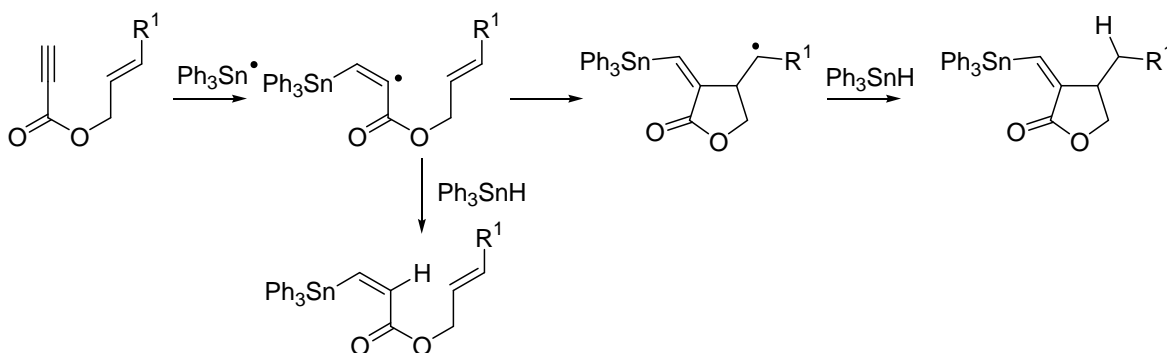

Scheme 6

A tin-free methodology based on dialkylzinc-mediated atom transfer sequential radical addition/cyclization has been developed by Bertrand and Feray.¹¹ As exemplified in Scheme 7, high yields in functionalized α -alkylidene- γ -lactams could be obtained.

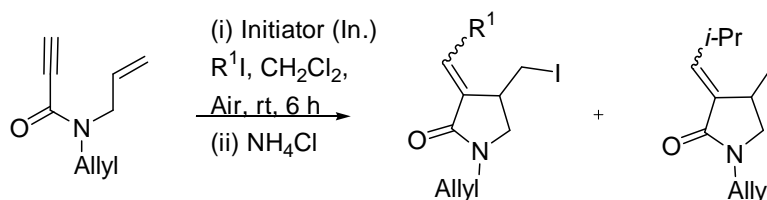

Entry	In. (equiv)	R ¹ I (equiv)	R ¹	Yield (E:Z)	Yield (E:Z)
1	Et ₂ Zn (1.5)	<i>t</i> -Bu I (10)	<i>t</i> -Bu	98% (92:8)	
2	Et ₂ Zn (0.6)	<i>t</i> -Bu I (10)	<i>t</i> -Bu	82% (88:12)	
3	Me ₂ Zn (1.5)	<i>t</i> -Bu I (10)	<i>t</i> -Bu	95% (88:12)	
4	Et ₂ Zn (0.9)	<i>i</i> -Pr I (10)	<i>i</i> -Pr	69% (80:20)	22% (78:22)
5	Et ₂ Zn (0.9)	<i>i</i> -Pr I (20)	<i>i</i> -Pr	84% (80:20)	5% (78:22)
6	Me ₂ Zn (1.5)	<i>i</i> -Pr I (10)	<i>i</i> -Pr	66% (80:20)	
7	Et ₃ B (2)	<i>i</i> -Pr I (10)	<i>i</i> -Pr	74% (80:20)	

Scheme 7

The competitive formation of the corresponding reduced lactams can be rationalized according to the mechanism shown in Scheme 8. Owing to the low C-Zn bond dissociation enthalpy, dialkylzincs readily undergo homolytic substitution, and therefore, when reacting with oxygen, they are convenient source of alkyl radical (Scheme 8). Ethyl radicals issued from diethylzinc, like methyl radicals, issued from dimethylzinc, can serve as relay to generate other alkyl radicals *via* iodine atom transfer from an appropriate alkyl iodide (R^1I).

The nucleophilic alkyl radical $R^{1\bullet}$ undergoes conjugate addition, the resulting vinyl radical **A** rearranges through 5-exo ring closure to give the primary radical **B**. The latter can either transfer an iodine atom from the alkyl iodide to form iodide **E**, which regenerates radical $R^{1\bullet}$, or reacts by homolytic substitution at the dialkylzinc to give a new organometallic species (**C**) which leads to **D** upon aqueous work-up. The amount of reduced lactam **D** depends on the competition between the two bimolecular steps.

In the case of diethylzinc, iodine atom transfer is faster whatever the amount of diethylzinc (Scheme 7, entries 1, 2) when the alkyl iodide is tertiary. In the presence of a secondary iodide, the rate of homolytic substitution at zinc leading to **C** competes with iodine atom transfer, unless a large excess of the alkyl iodide is used (Scheme 7, entries 4, 5). It is worth noting that iodine atom transfer is the only observed pathway when dimethylzinc (Scheme 7, entries 3, 6) or triethylborane (Scheme 7, entry 7) are used as mediators. Moreover, it must be pointed out that under these aerobic conditions no trace of recovered starting material that might result from competitive deprotonation of the triple bond *via* **F** is detected, which indicates that reaction with oxygen is much faster than proton transfer even for dimethylzinc. The latter is more basic than diethylzinc. In addition, its oxidation rate is far slower.

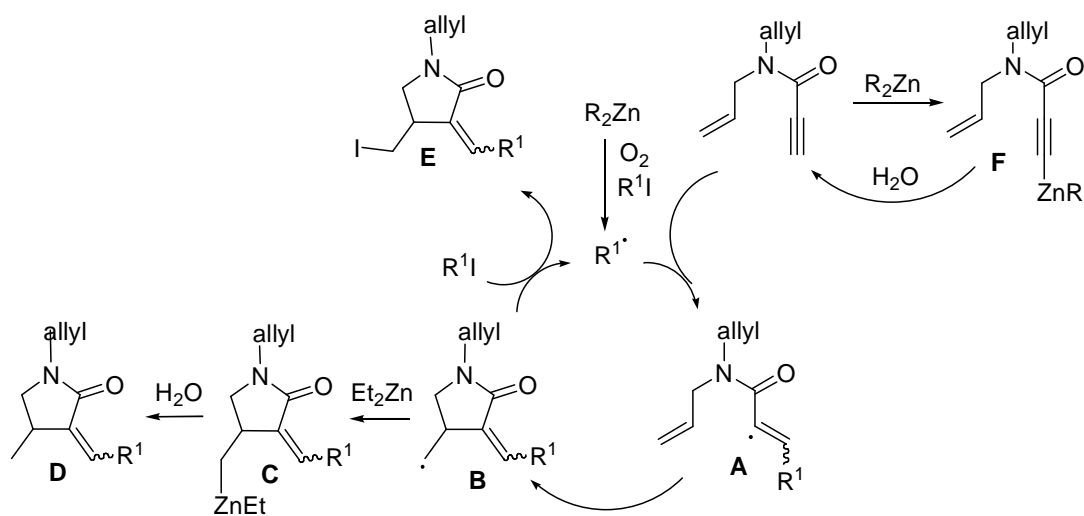

Scheme 8

These experimental conditions could not be applied to the synthesis of α -alkylidene- γ -lactones, since at room temperature the intermediate vinyl radical cannot reach the appropriate conformation to undergo ring closure, and the rotation around the ester bond is too slow (Scheme 9). The intermediate vinyl radical can either undergo iodine atom transfer or be transformed into a zinc allenoate *via* homolytic substitution at the dialkylzinc. The same difficulty applies to α -carbamoyl alkyl radicals, but in this case the problem can be overcome by selecting a suitable second substituent at the nitrogen atom.¹²

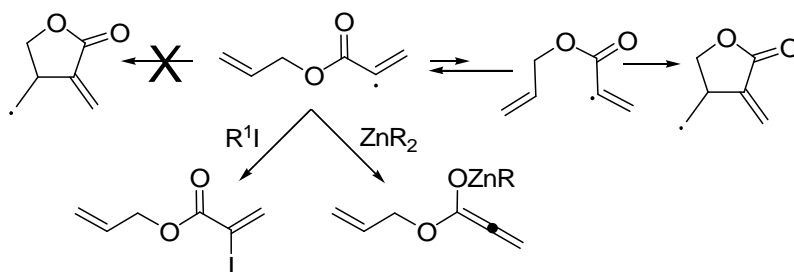

Scheme 9

2.2.2. Tandem addition of electrophilic radicals to double bond/5-exo ring closure onto conjugated alkyne

Lu and Wang have used a similar strategy based on atom transfer radical addition followed by 5-exo ring closure to prepare α -alkylidene γ -lactones (Scheme 10) and γ -lactams (Scheme 11) bearing perfluoroalkyl chains.¹³

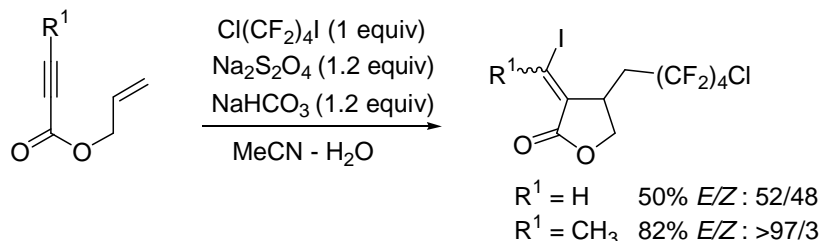

Scheme 10

The formation of perfluoroalkyl radical is initiated by electron transfer with sodium dithionite at 10–15 °C. The electrophilic radical adds to the most electron rich unsaturation, *i.e.* the double bond, to give a δ -unsaturated alkyl radical which undergoes 5-exo ring closure. Regarding lactone ring closure, it must be underlined that, even though the reaction is performed at low temperature, the 5-exo-*dig* cyclization mode is not impeded by the rotational barrier around the ester C-O bond. In all likelihood, this is due to the linear structure of the alkynyl group. However, the strategy failed to prepare 6- and 7-membered analogs.

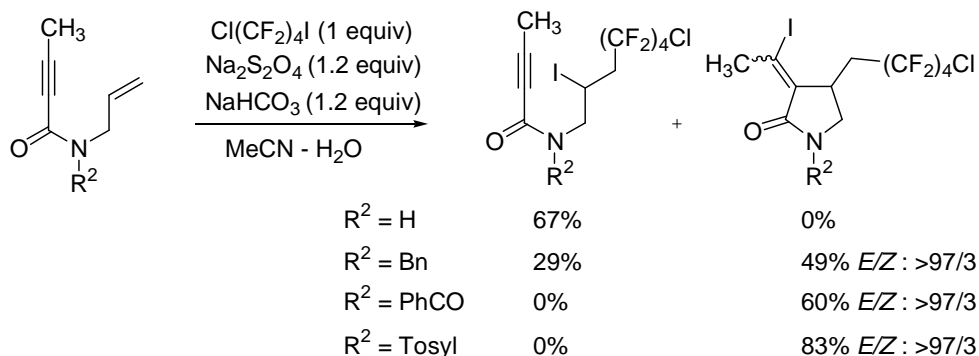

Scheme 11

Regarding the synthesis of γ -lactams, the nature of the substituent at the nitrogen atom is crucial. Bulky electron withdrawing groups are the best choice to favour the cyclization at the expense of iodine

atom transfer leading to the simple adduct of the perfluoroalkyl iodide to the double bond (Scheme 12). In both cases vinyl iodides are formed through the final iodine atom transfer propagation step. A mixture of *E* and *Z* isomers is formed, and they can be reduced by the couple Zn/AcOH to give the targets molecules.

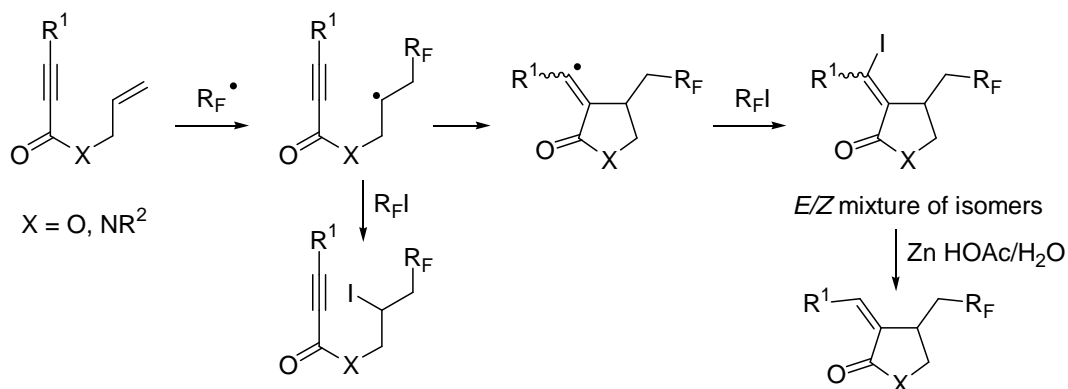

2.3. Iodine atom transfer-mediated cyclization onto conjugated alkyne

The synthesis of racemic methylenolactocin was achieved by Weaver *via* ATRAC (Atom Transfer Radical Cyclization).¹⁴ The reaction differs from the above detailed processes since no intermolecular radical addition is involved, the substrate is a α -iodoester which rearrangement is driven forward by the relative bond strengths of the initial Csp^3 -I bond and the final Csp^2 -I bond (Scheme 13).

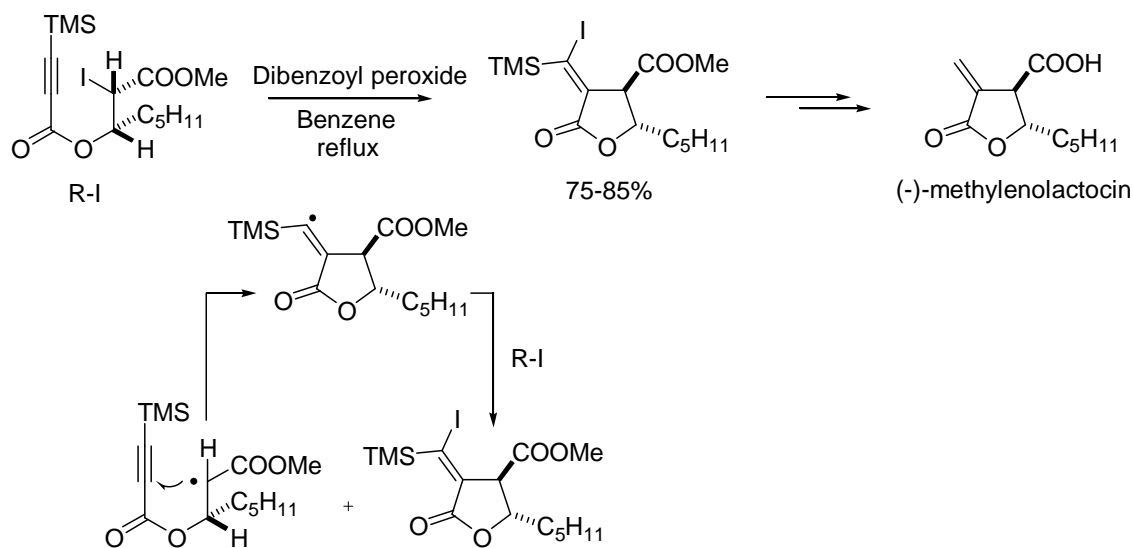

2.4. Two-step strategies involving 5-exo-dig cyclization followed by oxidation of resulting 3-alkylidene-tetrahydrofuranes

Standard procedures involving tributyltin hydride-mediated cyclization of alkyl radicals onto triple bonds have been applied to the two-step formation of α -methylene- γ -lactones. Numerous examples have been reported making use of different radical precursors like bromides, or thiocarbonyl derivatives.¹⁵ As an

example, a xanthate precursor was used for the synthesis of discosiolide.^{15b} Cossy and co-workers have achieved the synthesis of racemic isoavenaciolide *via* the 5-exo cyclization of a β -bromo propargylic ether mediated by photo-induced electron transfer with triethylamine (Scheme 14).¹⁶

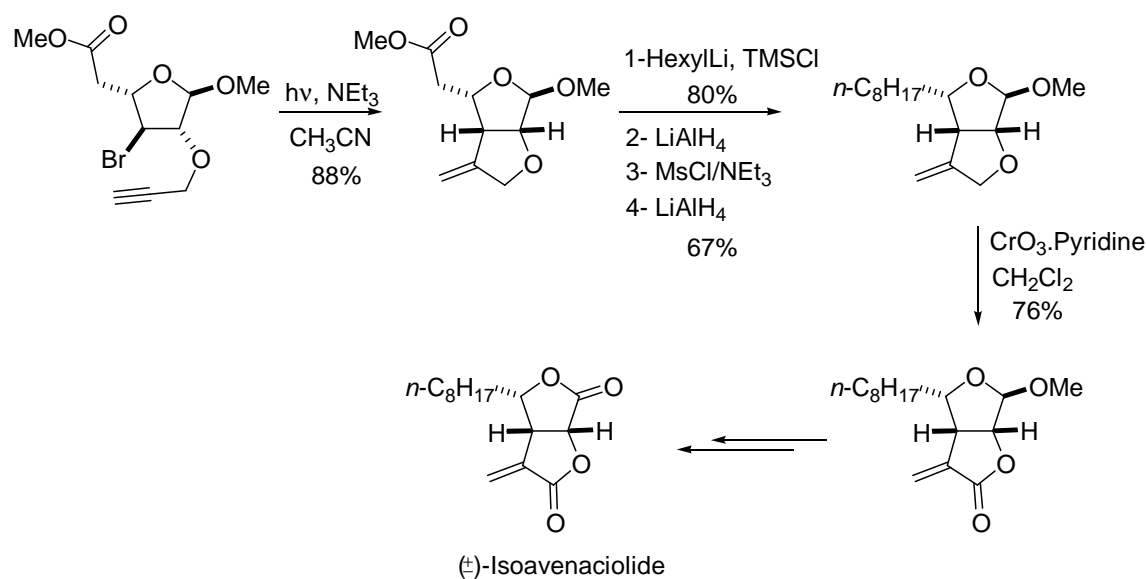

Scheme 14

Other radical methodologies like titanium(III)-induced reduction of epoxides¹⁷ or cobalt(II) reduction of halides¹⁸ have also been investigated. Application to the preparation of racemic protolichesterinic acid is exemplified in Scheme 15.

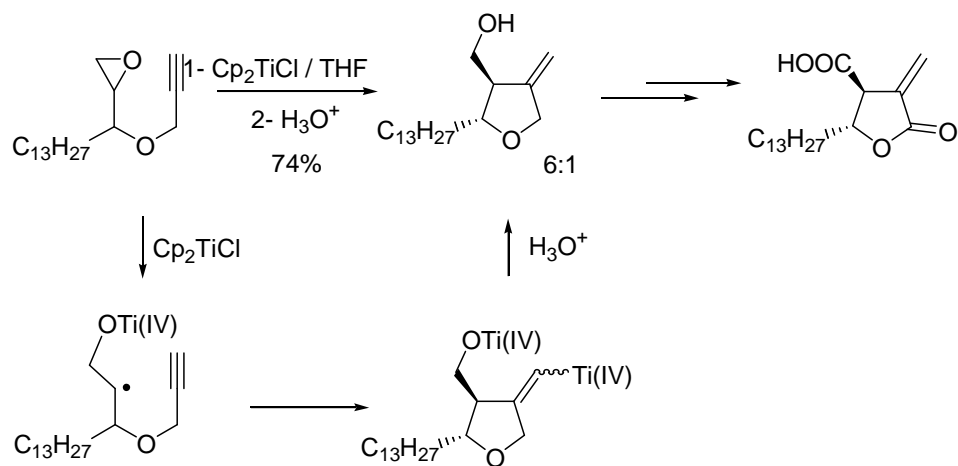

Scheme 15

Kilburn and co-workers have developed an original cascade for the synthesis of paeonilactone B (Scheme 16).¹⁹ The process starts with 5-exo ring closure of samarium-ketyl radical. The resulting methylcyclopropyl radical undergoes ring opening. Intramolecular trapping of the homoallylic radical by the triple bond is followed by hydrogen atom transfer from the solvent.

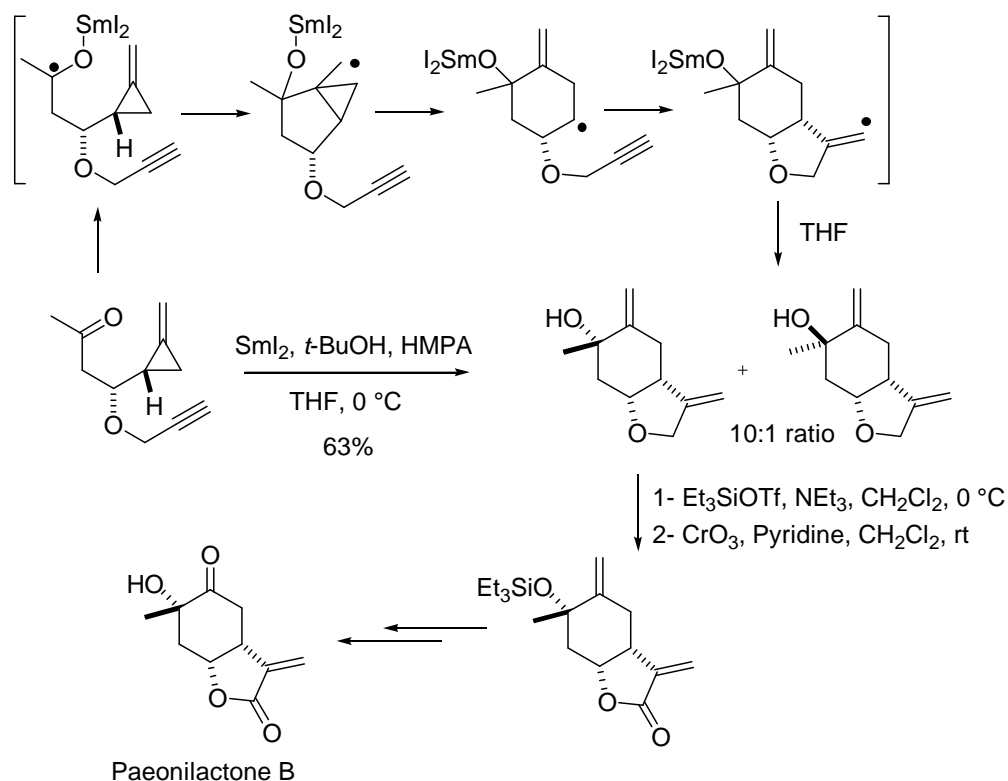

Scheme 16

3. Transition metal-mediated cyclizations

Most of the above radical methodologies have their counterpart in transition metal-mediated cyclizations. However, transition metal-catalyzed processes offer a wider range of approaches. Most importantly, they can be more readily adapted to enantioselective synthesis *via* the use of appropriate optically pure ligands. It must be emphasized that, even though catalytic enantioselective radical additions are known, they have not been applied yet to lactones and lactams synthesis.²⁰

3.1. Cyclization of alkoxy-carbonyl- and carbamoyl- metal complexes onto triple bond

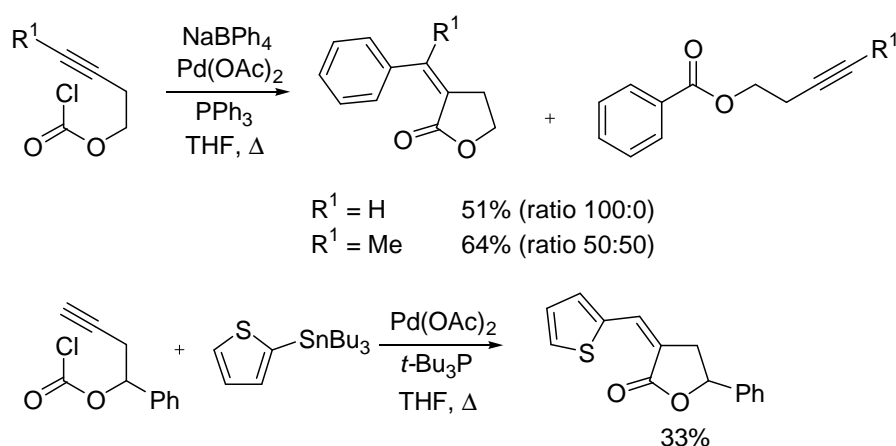

Scheme 17

Grigg and Savic have reported the Pd(0)-catalyzed cyclization of unsaturated chloroformates.²¹ The resulting vinyl-palladium complex is further functionalized *via* coupling with Ph₄BNa or with organostannanes. As shown in Scheme 17, cyclization is slowed down with non terminal triple bonds. Competitive direct coupling of the alkoxy carbonyl-palladium(II) complex is observed in this case.

Norton and co-workers were the first to develop α -methylene- γ -lactone synthesis *via* the cyclization of alkoxy carbonyl-palladium intermediates.²² The latter were generated *in situ* through the carbonylation of homopropargylic alcohols in the presence of a Pd(II) catalyst (Scheme 18). The best catalytic system was PdCl₂ in the presence of anhydrous SnCl₂ and PPh₃ in acetonitrile as the solvent.

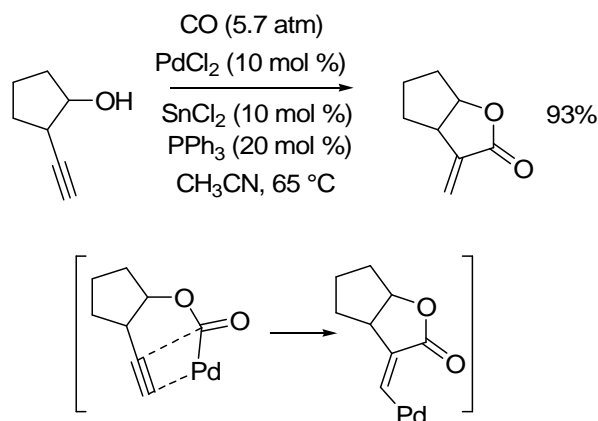

Scheme 18

Carbamoyl-rhodium complexes, generated from formamides and Rh(0) catalyst, rearrange similarly to give α -alkylidene- γ -lactams.²³ According to the data given in Scheme 19, the presence of a bulky substituent at the nitrogen atom is of prime importance to favour the cyclization process. Like previously in radical cyclization, the rotational barrier can be too high to enable the intermediate complex to reach the conformation appropriate to the cyclization.¹²

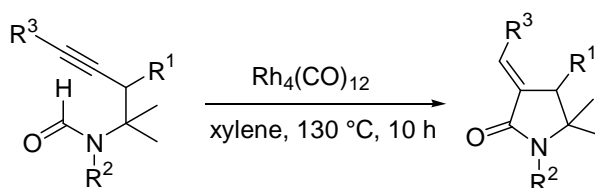

R ¹	R ²	R ³	yield (%)
H	Bn	Ph	72
H	Bn	Bu	56
H	Me	Ph	36
H	H	Ph	0
OMe	Bn	Bu	74

Scheme 19

The proposed mechanism is given in Scheme 20: it involves oxidative addition of the formamide to Rh(0), followed by insertion of the triple bond into the Rh-H bond (*cis* addition) and reductive elimination of the lactam regenerating Rh(0).

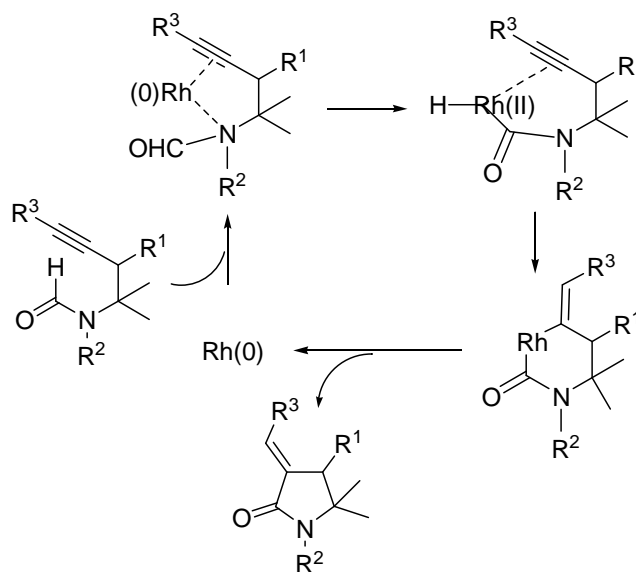

Scheme 20

3.2. Enyne cyclization

3.2.1. Palladium-catalyzed reactions

Lu and co-workers have reported an extensive investigation of both α -methylene- γ -lactones and γ -lactams synthesis *via* processes starting with halo-, acetoxy-, or carbo-palladation of enynes bearing electron-deficient triple bonds.^{24–31}

3.2.1.1. Halopalladation

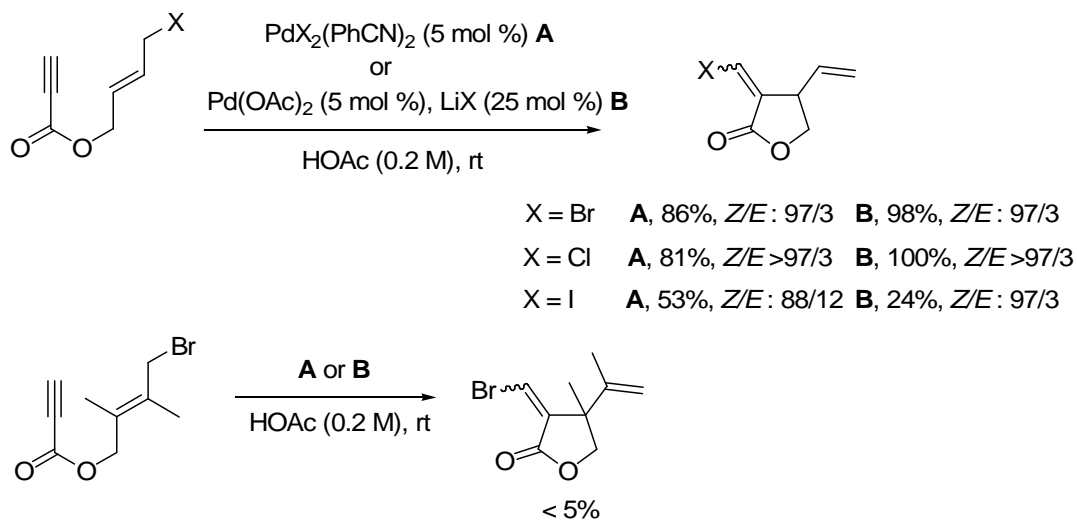

Scheme 21

In the cyclization of allyl propynoates the use of zero-valent Pd species was precluded since they would have led to the cleavage of the allylic C-O bond. Pd(0) active species are easily generated *in situ* from divalent palladium complexes. The use of bis(benzonitrile)palladium dichloride and dibromide enabled the formation of the halogenated heterocyclic targets from precursors that incorporated both a carbon-carbon triple bond and an allylic halide. The highest yields were observed using acetic acid as the solvent. The reaction could also be performed with Pd(OAc)₂ as the catalyst, in the presence of lithium halides, without competitive acetoxylation of the product (Scheme 21). The reaction was also applied to non terminal activated alkynes, but led to very low yields with sterically hindered double bonds.²⁴

The high stereoselectivity of the process implies the mechanism proposed in Scheme 22. External nucleophilic attack of the halide anion leads to *trans* halo-palladation of the triple bond, which is followed by 5-exo ring closure, then β-elimination regenerates the Pd-dihalide.

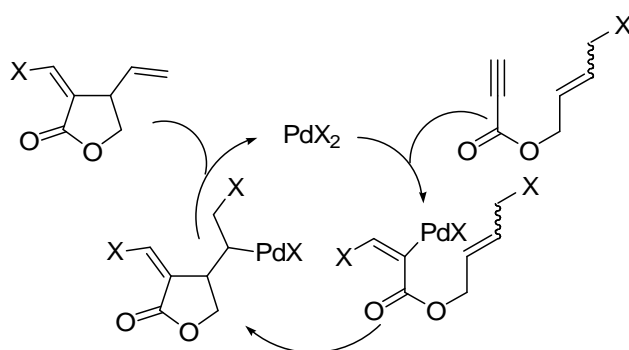

Scheme 22

In the allylic halide moiety, the halide can be replaced by other leaving groups like acetoxy group. The reaction is highly diastereoselective, leading to β,γ-*trans*-disubstituted lactones from unsubstituted propynoates and to β-γ-*cis*-disubstituted lactones from substituted propynoates. Advantage was taken from this selectivity for the total synthesis of both enantiomers of methylenelactocin,^{25a,b} phaseolinic acid (Scheme 23),^{25c} and isohomopilocarpic acid.^{25d}

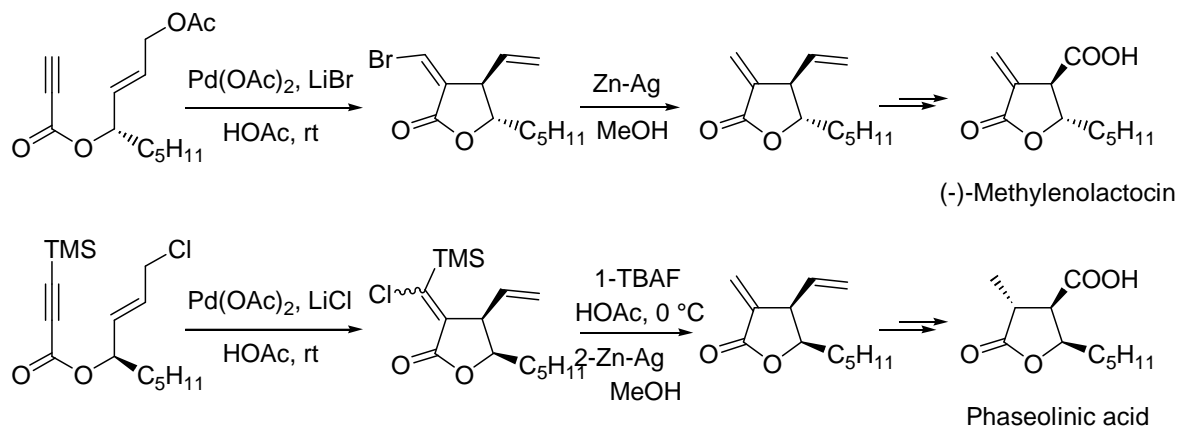

Scheme 23

The same protocols were extended to the synthesis of α -alkylidene γ -butyrolactams.²⁶ As compared to allylic esters, there is little risk of cleavage of the allylic C-N bond. The rate of the reaction is dependent on the nature of the substituent at the nitrogen atom. *N*-Benzyl amides are the most reactive substrates, owing to the favourable influence of the benzyl group on the conformational equilibrium around the amide bond.

As illustrated in Scheme 24, the procedure was applied to build the γ -lactam ring in the synthesis of isocynometrine.²⁶

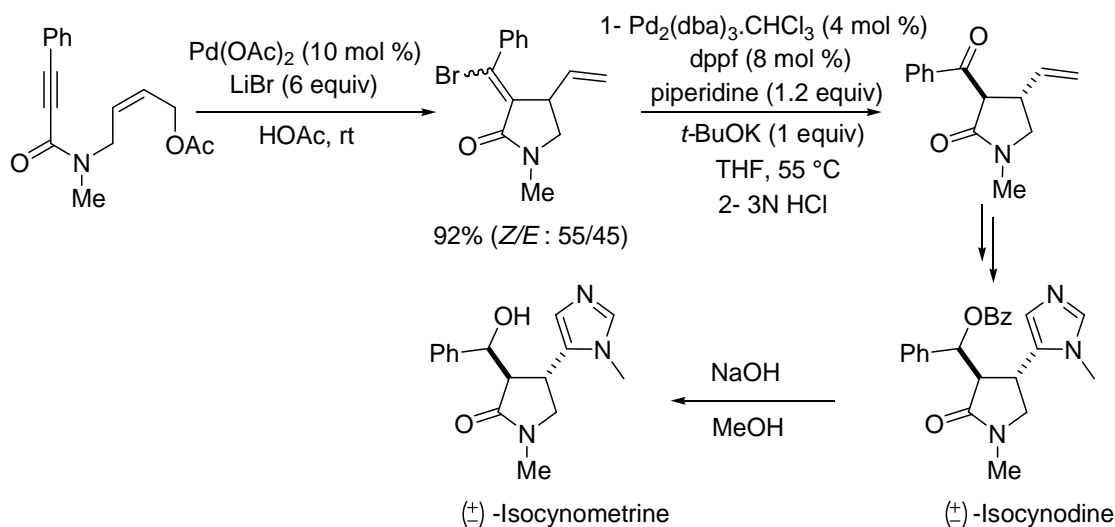

Scheme 24

When the allylic halide moiety was replaced by an α,β -unsaturated aldehyde, the reaction ended with a protonation step (it might involve the formation of a Pd enolate readily protonated under the reaction conditions). The resulting lactonic bromo aldehyde was used to prepare both enantiomers of pilocarpine after separation of the diastomeric acetals formed through reaction with dimethyl tartrate.^{25d}

γ -Lactams analogs were also prepared in high yields (Scheme 25).²⁷ The selectivity in favour of the *Z*-exocyclic double bond generally decreases when the substituent at the terminus of the triple bond becomes bulkier, as observed for the lactone ring closure.²⁴

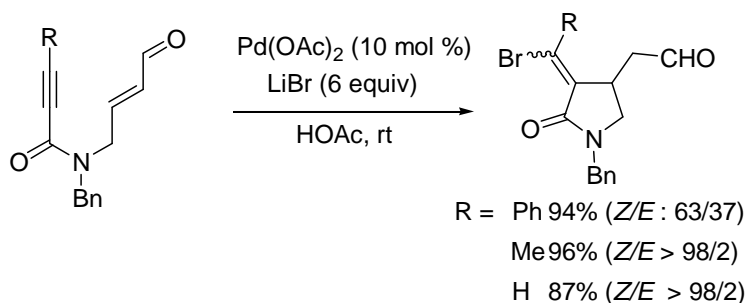

Scheme 25

When the allylic chain is unsubstituted or when it bears alkyl or phenyl groups at its terminus, chloropalladation carried out in the presence of an excess of cupric chloride leads to dichloro-lactams. Oxidative cleavage follows the ring closure step (Scheme 26).^{28a} The same reactivity can be applied to lactone ring closure.^{25c,28b,c}

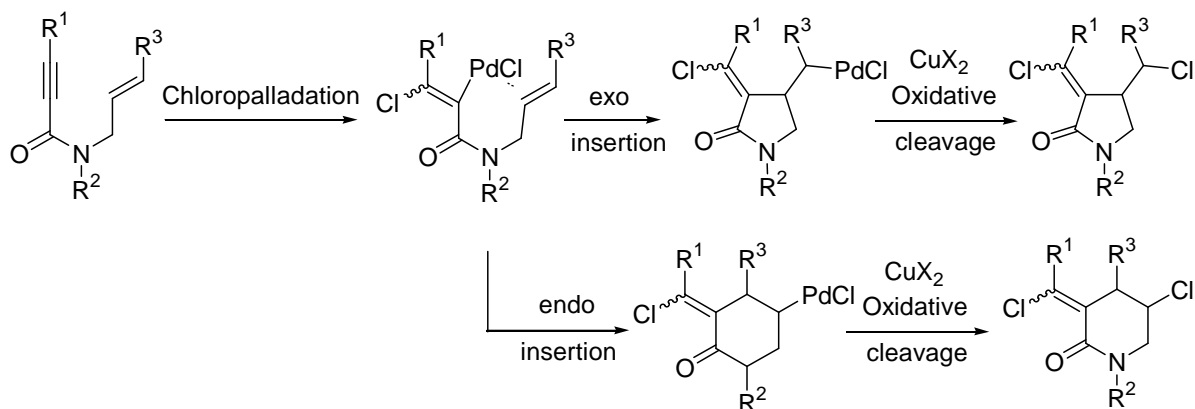

Scheme 26

As exemplified in Scheme 27, the reaction may not be chemoselective. A clean influence of the conformational equilibrium of the amide is registered. Competitive chlorination of the triple bond occurred with terminal alkyne ($R^1=H$) with secondary amides ($R^2=H$). Preferential 6-endo ring closure occurred when the substituent was bulky ($R^2=Ts$).

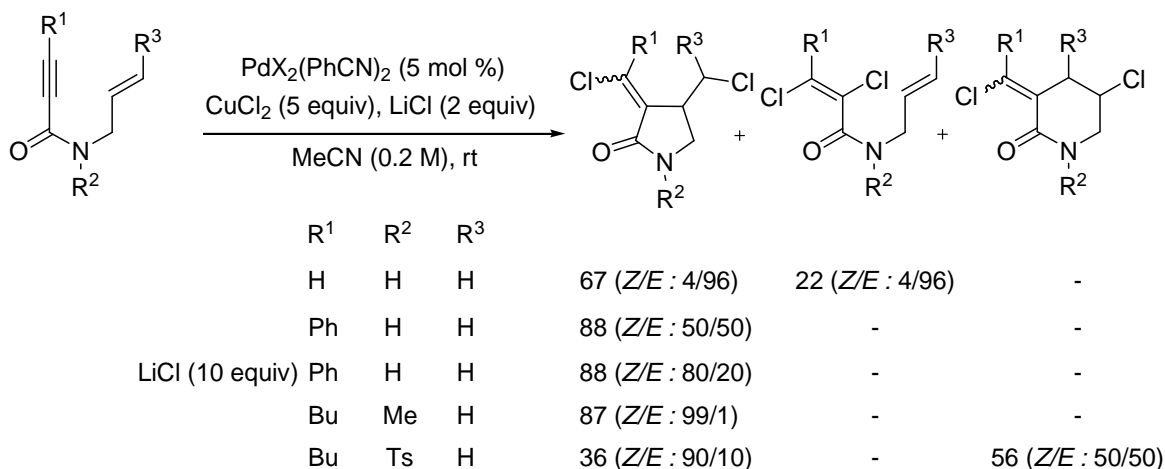

Scheme 27

The cyclization of enynes bearing a non functionalized ethylenic tether, was recently achieved by performing the reaction in imidazolium-type ionic liquids in the presence of residual water or under dry HCl atmosphere (Scheme 28).²⁹ In the absence of oxidant, protonolysis of the final C-Pd bond, occurred.

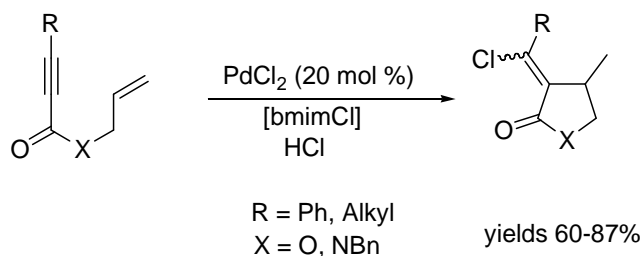

Scheme 28

3.2.1.2. Acetoxypalladation

Closely related results were obtained with $\text{Pd}(\text{OAc})_2$ in the presence of bipyridine in acetic acid at 80 °C. Acetoxypalladation of the activated alkyne is followed by intramolecular insertion of the alkene. Protonolysis of the C-Pd bond in the presence of the bidentate ligand completes the catalytic cycle and regenerates the catalyst.^{30a} However, rather low yields were observed for lactam ring closure and no γ -lactone could be isolated from the corresponding alkynoate (Scheme 29).

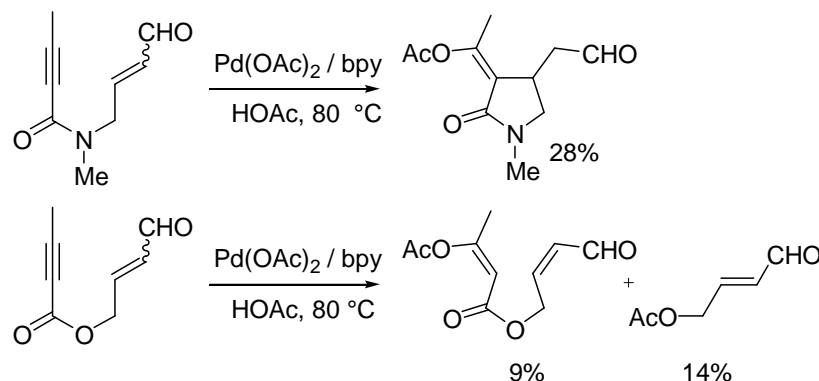

Scheme 29

Asymmetric synthesis was achieved in high yield with moderate enantioselectivity in the presence of pyridyl monooxazoline or bisoxazoline chiral ligands using the benzoyl ester of the reduced aldehyde as starting material (Scheme 30).^{30b,c} In this case the last step is a β -elimination.

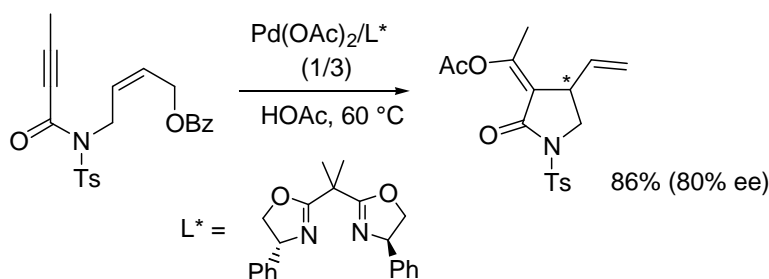

Scheme 30

3.2.1.3. Carbopalladation

When standard conditions for Heck reaction were applied to enynes amides, *i.e.* 10 mol% $\text{Pd}(\text{OAc})_2$, 20 mol% PPh_3 , 1.5 equiv of Et_3N (or in the presence of Ag_2CO_3), in acetonitrile at 70 °C, a mixture of dienic γ -lactams was isolated in low yields (Scheme 31). Ending the process with a β -elimination did not meet the criteria of chemoselectivity for a synthetically viable methodology.³¹

However, when tandem carbopalladation/cyclization, carried out in the presence of secondary amines, was applied to *N*-(2',4'-dienyl)alkylamides, the lactams resulting from the incorporation of the nucleophilic amine were isolated in yields close to 70%. However, competition with Diels-Alder reaction interfered in the case of electron-deficient aryl iodides. The [4+2] cycloadduct was the only product when aniline was used as the nucleophile instead of piperidine.³¹

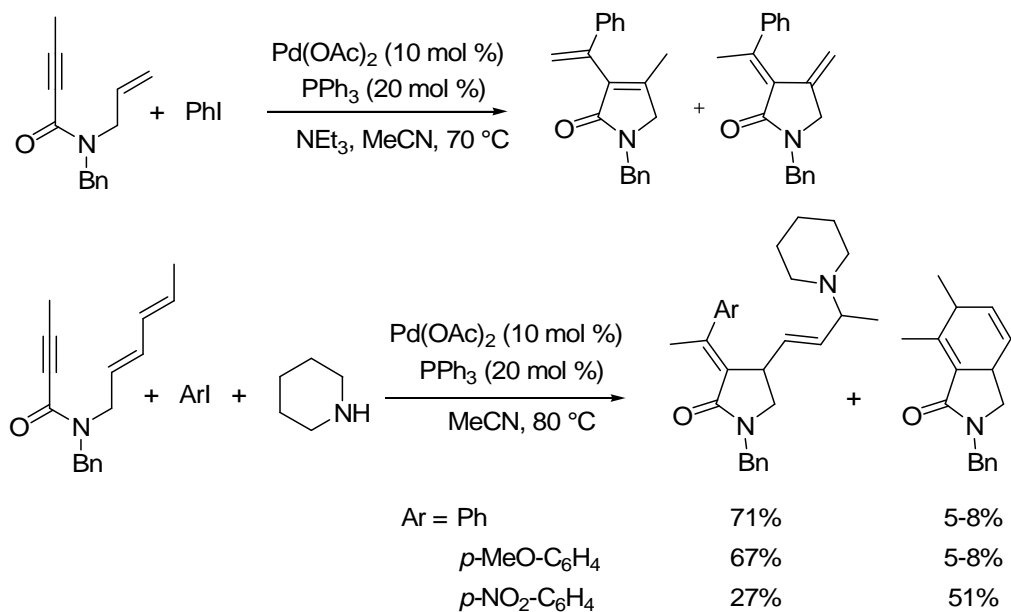

Scheme 31

According to the mechanism in Scheme 32, 5-*exo* cyclization leads to a π -allyl palladium(II) intermediate which undergoes nucleophilic substitution at the remote site.

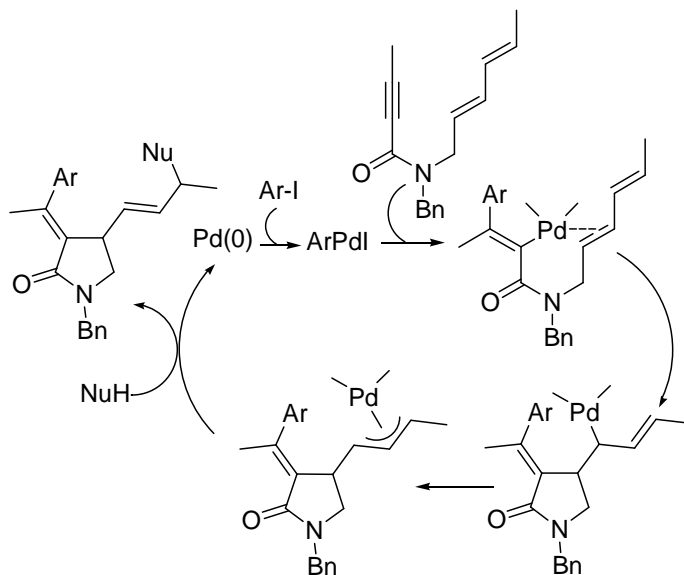

Scheme 32

3.2.1.4. Tandem cyclization/Suzuki coupling

The above mechanism (Scheme 32), involving carbopalladation as the first step, was discarded as a rationale for palladium(0)-catalyzed cyclization of 1,6-enynes in the presence of arylboronic acid (Scheme 33).³² The reaction gave very poor results when Pd(II) complexes were used as catalysts.

A catalytic cycle involving first oxidative addition of the allylic halide to Pd(0), followed by insertion of the alkyne in the π -allyl intermediate and final Suzuki coupling of the resulting vinylpalladium complex was proposed (Scheme 34).

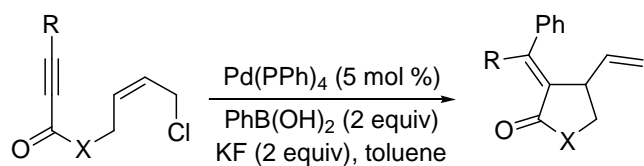

R = Ph, Alkyl
X = O, NBn, NTs yields 45-93%

Scheme 33

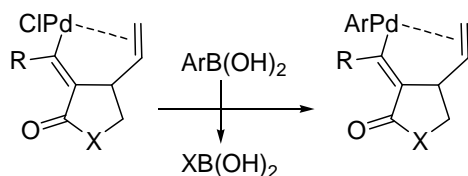

Scheme 34

Asymmetric cyclization of aroylmethyl 2-alkynoates was recently achieved with *in situ* formation of a cationic aryl-palladium(II) complex. Hydroxylactones were isolated in good yields with enantiomeric excesses ranging between 62–92% (Scheme 35).

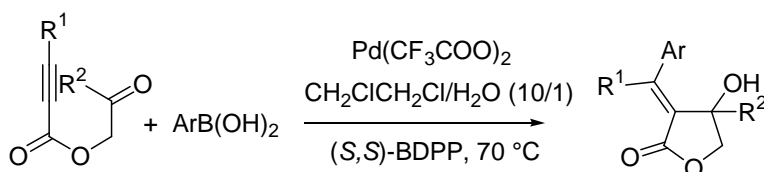

R² = Ar, Me
R¹ = Ar, Alkyl

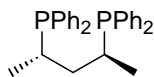

yields 65-92%
ee 62-92%

Scheme 35

3.2.2. Rhodium(I)-catalyzed reactions

3.2.2.1. Cycloisomerization of 1,6-enynes

Zhang and co-workers have developed Rh cationic complexes-catalyzed cycloisomerization of 1,6-enynes.³³ A variety of amides bearing functional groups at the allylic position were cycloisomerized.^{33a} The reaction was totally regioselective and high enantiomeric excesses were observed in the presence of binap (Scheme 36). Enol ethers and enamides could be prepared in high yields.

The compatibility with allylic acetate is an advantage of Rh(I) as compared to other metals like Pd(0). The intermediacy of a π -allyl Rh(III) complex was ruled out. A mechanism involving coordination of the *in situ* generated cationic Rh(I) species to the enyne (**a**), followed by oxidative coupling leading to a metallacycle (**b**), regio- and stereoselective β -H elimination leading to (**c**), and reductive elimination was proposed (Scheme 37).

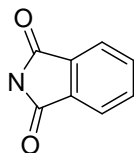
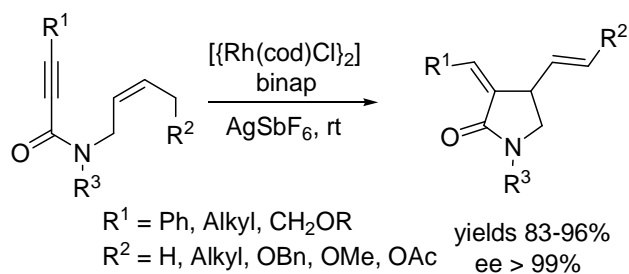

$\text{R}^3 = \text{Bn, Me}$

Scheme 36

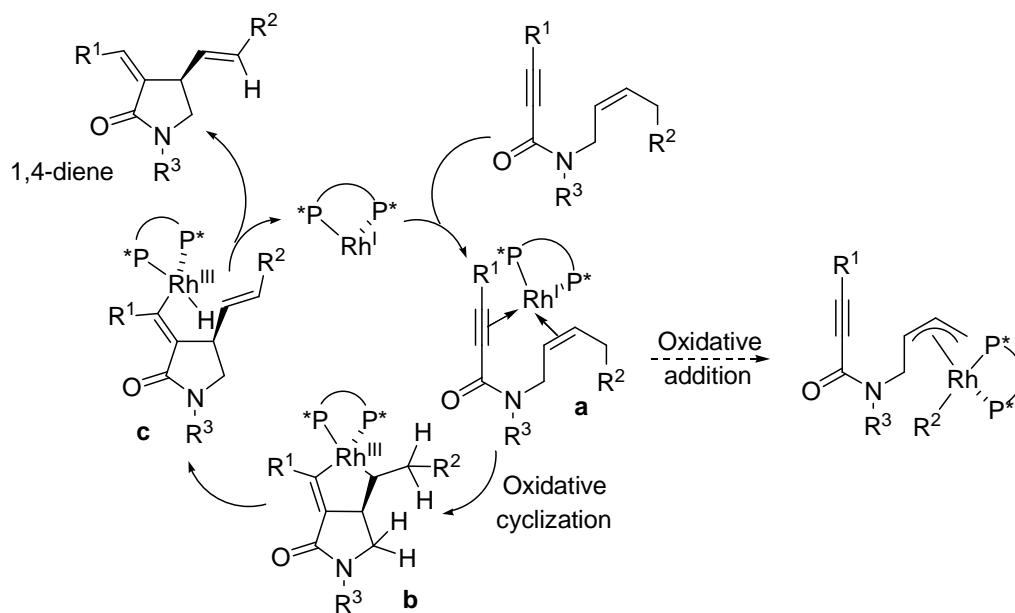

Scheme 37

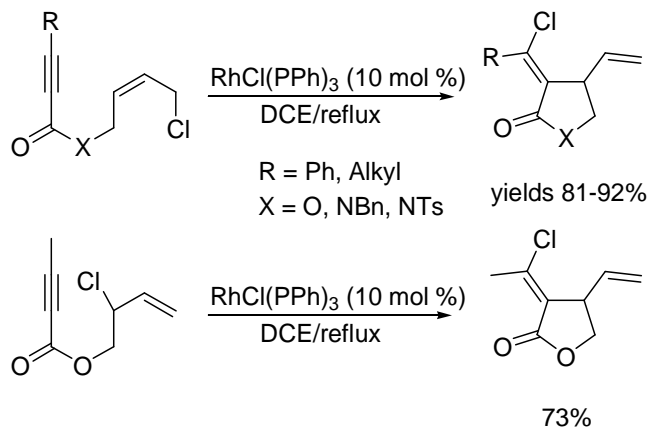

Scheme 38

The Rh(I)-catalyzed cyclization was extended to esters and amides bearing an allylic chloride moiety using Wilkinson catalyst.^{33b,c} The reaction proceeded with halogen shift.

The formation of vinylic chlorides *via* reductive elimination is known to require harsh conditions, therefore pathway **a** (implying oxidative cyclometallation) and pathway **b** (implying halorhodiation/insertion/ β -halogen-elimination) were discarded. Pathway **c**, involving the initial formation of a π -allyl rhodium species, was suggested (Scheme 39). It was supported by the observation that the isomeric allylic chlorides in Scheme 38 led to the same product.

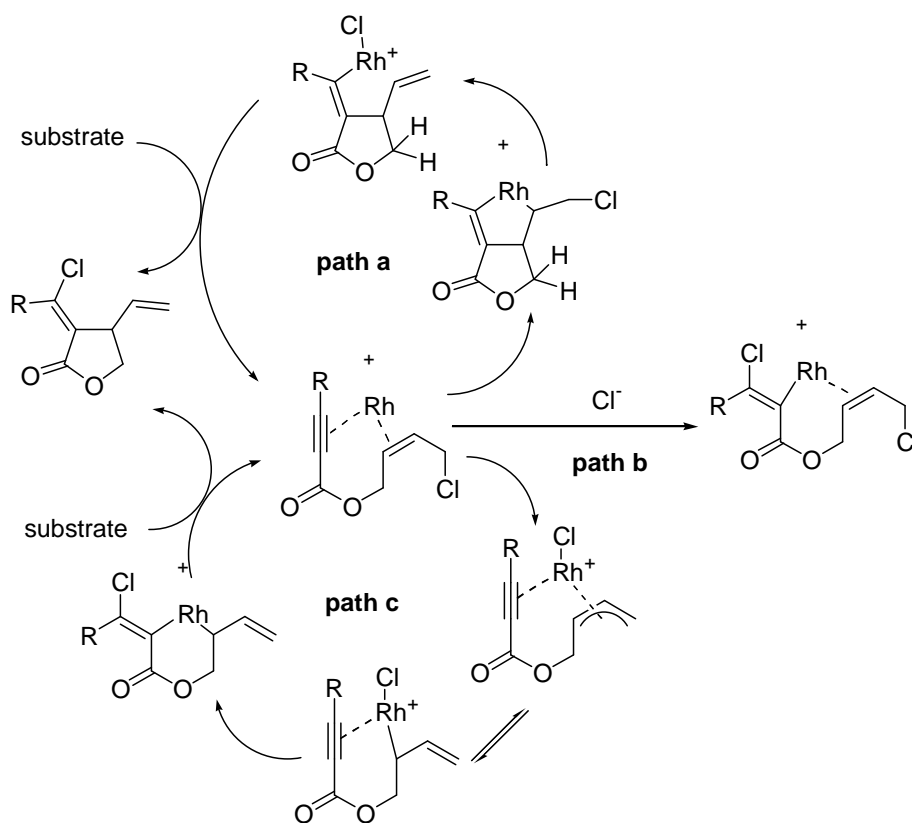

Scheme 39

3.2.2.2. Reductive cycloisomerization of 1,6-enynes and acetylenic aldehydes

Krische and co-workers have achieved highly enantioselective reductive cyclizations of 1,6-enynes³⁴ and acetylenic aldehydes.³⁵

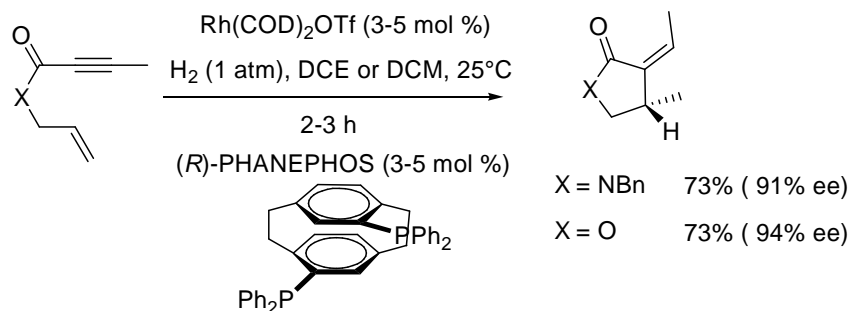

Scheme 40

(*R*)-PHANEPHOS was exceptionally efficient compared to other ligands to promote the formation of α -alkylidene- γ -lactams and γ -lactones in good yields with high enantiomeric excess in the case of enynes (Scheme 40). Mechanistic studies suggest that the reaction proceed through the formation of a metallacycle *via* a fast oxidative coupling followed by hydrogenolytic cleavage.

The cyclization of acetylenic aldehydes leading to 4-hydroxy- γ -lactones and 4-hydroxy- γ -lactams was carried out upon exposure to gaseous hydrogen in the presence of a rhodium precatalyst.³⁵ The chiral modified cationic rhodium catalyst enabled the formation of the allylic alcohol moiety (Scheme 41). The best enantioselectivity was observed with (*R*)-Cl, MeO-BIPHEP as the chiral ligand. Both the rate of the reaction and the conversion were enhanced in the presence of a Brønsted acid additive. Aryl, alkyl and cyclopropyl substituents are tolerated at the alkyne terminal carbon.

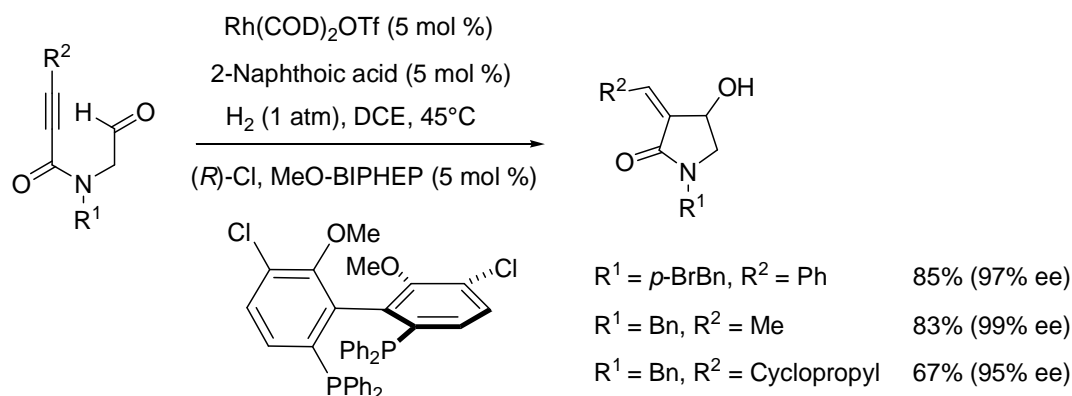

Scheme 41

According to deuterium labeling experiments, the mechanism is similar to that proposed for 1,6-enynes. The data are consistent with oxidative coupling followed by protonation and hydrogenolysis. The latter would occur *via* σ bond metathesis (hydrogen oxidative addition leading to Rh(V) intermediates is highly unlikely) (Scheme 42).

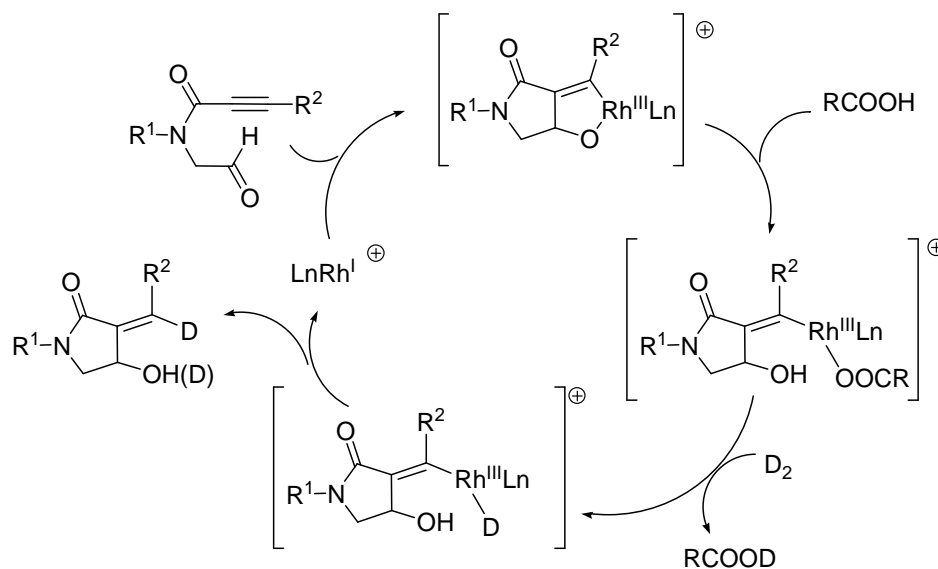

Scheme 42

3.2.3. Alkenylative cyclization promoted by ruthenium catalyst

During their investigation of enyne metathesis, Mori and co-workers have discovered that ruthenium catalysts could be efficient to promote the cyclization of enynes.³⁶ In the presence of ethylene, known to be an efficient promoter for metathesis reactions, all the carbons contained in the substrate were recovered in the final product and two additional carbons were incorporated. After optimization, Cp**RuCl(cod)* was found to be the best catalyst for this transformation. The reaction led to an α -dienyl- γ -lactam in 49% yield when starting from the corresponding amide (Scheme 43).

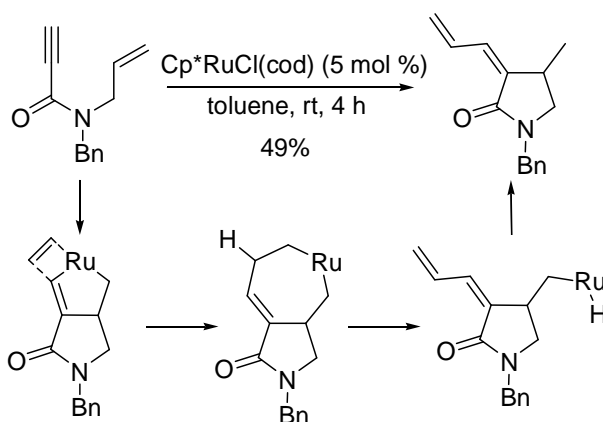

A tentative rationale is given in Scheme 43. Oxidative coupling would be followed by ethylene insertion in the Ru-C sp^2 bond of the resulting metallacycle, β -elimination and reductive elimination would lead to the product.

3.3. Two-step procedures involving Pd(0)-mediated cyclization followed by oxidation

This strategy to prepare α -methylene- γ -lactones can be viewed as equivalent to the radical methodology in § 2.4.

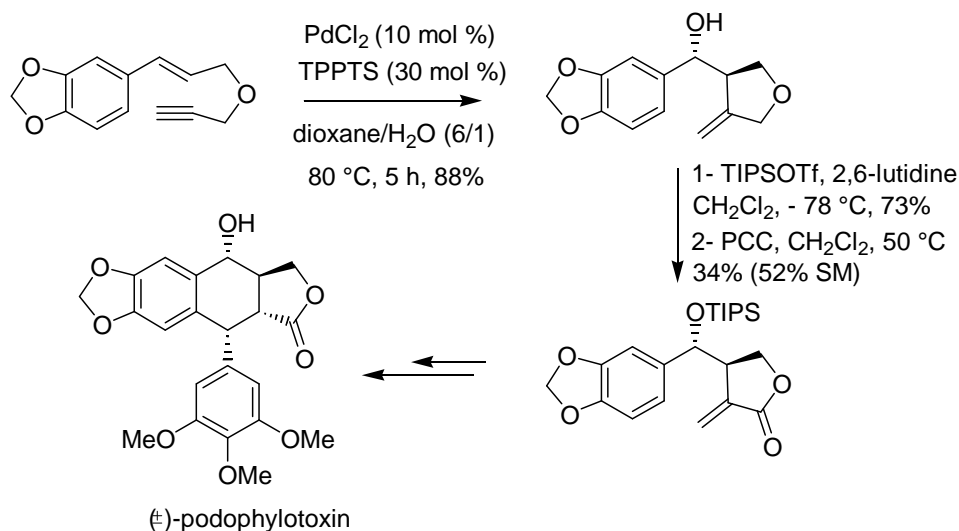

Genêt and co-workers have devised a route to racemic podophyllotoxin based on the cyclization of an enyne *via* hydroxypalladation followed by oxidation with PCC after protection of the resulting alcohol (Scheme 44).³⁷

In a complementary approach, Aggarwal has investigated the cascade Pd-catalyzed cyclization/carbonylation starting from a vinylic bromide. The resulting heterocycle was easily oxidized by py-CrO₃ to form the α -methylene lactone (Scheme 45).³⁸

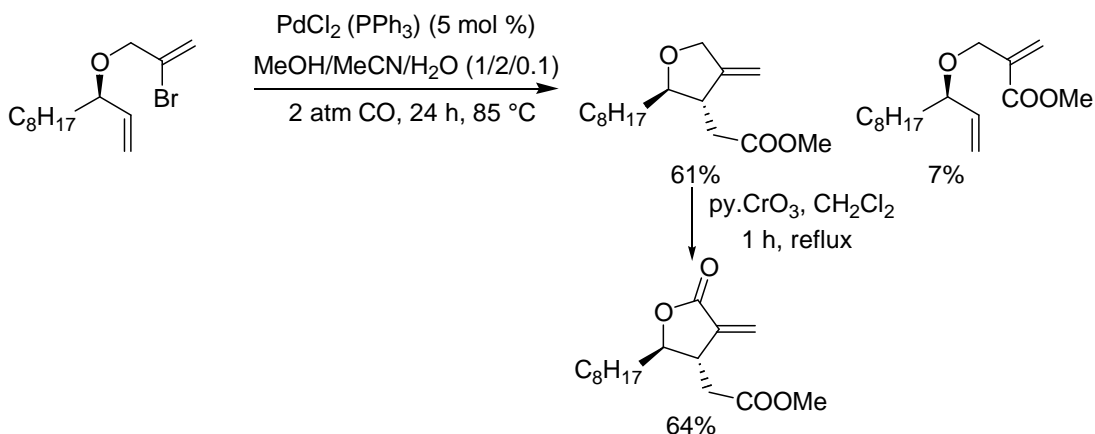

Scheme 45

3.4. Miscellaneous methodologies

3.4.1. Cycloalkenylation of tungsten-alkynyl amines

Tungsten-alkynyl compounds react with carbon electrophiles at the C _{β} -carbon to form tungsten-allenylium cations which can be trapped by nucleophiles (Scheme 46). Tungsten- η^1 - α,δ -alkynyl amines were prepared from CpW(CO)₃Cl, in the presence of diethylamine and CuI catalysts. Upon treatment with acetaldehyde or benzaldehyde in the presence of 1 equiv of BF₃·Et₂O they gave rise to tungsten- η^1 -pyrrolylium salts. Oxidative demetallation with *m*-CPBA or Me₃NO led to α -alkylidene- γ -lactams in good yields (Scheme 46). It can be noted that attempts to prepare larger nitrogen heterocycles failed *via* this methodology.³⁹

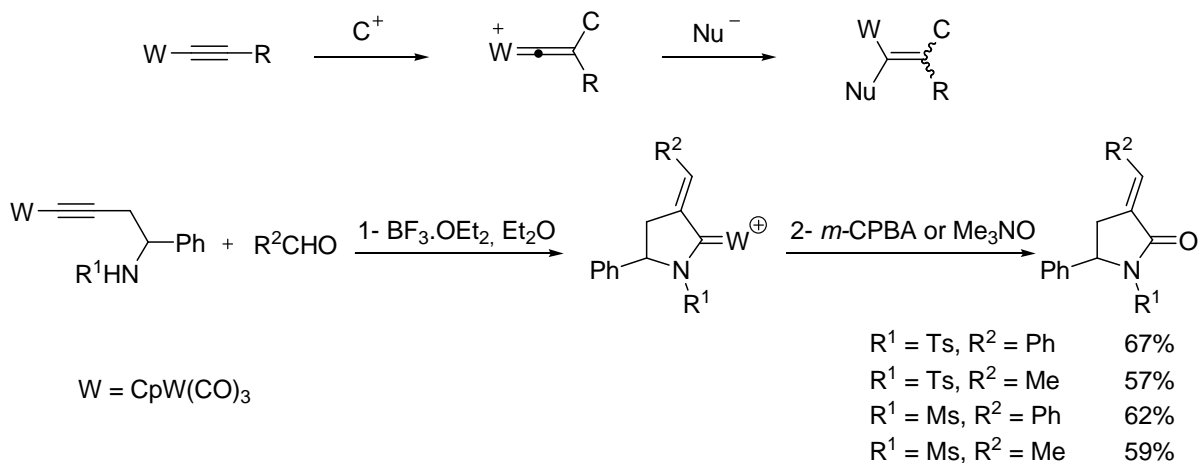

Scheme 46

3.4.2. Cyclization involving Pd(0) as the leaving group

Procedures, related to classical ester synthesis *via* either nucleophilic substitution with a carboxylate as the nucleophile or displacement of an acyl halide with an alcohol, can be mediated with Pd-complexes.

3.4.2.1. Pd-catalyzed heteroannulation of 1,3-dienes

α -Alkylidene- γ -lactones are readily available through the Pd(0)-catalyzed reaction of α -iodo- or α -bromo-acrylic acids with 1,3-dienes. The best yields were obtained in the presence of a sterically hindered chelating phosphine, *i.e.* (di-*tert*-butylphosphino)ferrocene (D-*t*-BPF) (Scheme 47).⁴⁰

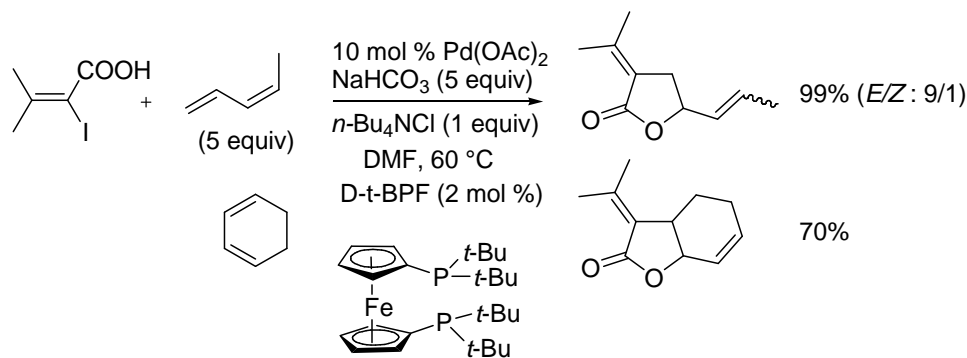

Scheme 47

The reaction is likely to proceed *via* oxidative addition of the vinylic halide to Pd(0), followed by regioselective insertion of the 1,3-diene leading to a π -allylpalladium intermediate which undergoes nucleophilic displacement by the carboxylate (Scheme 48).

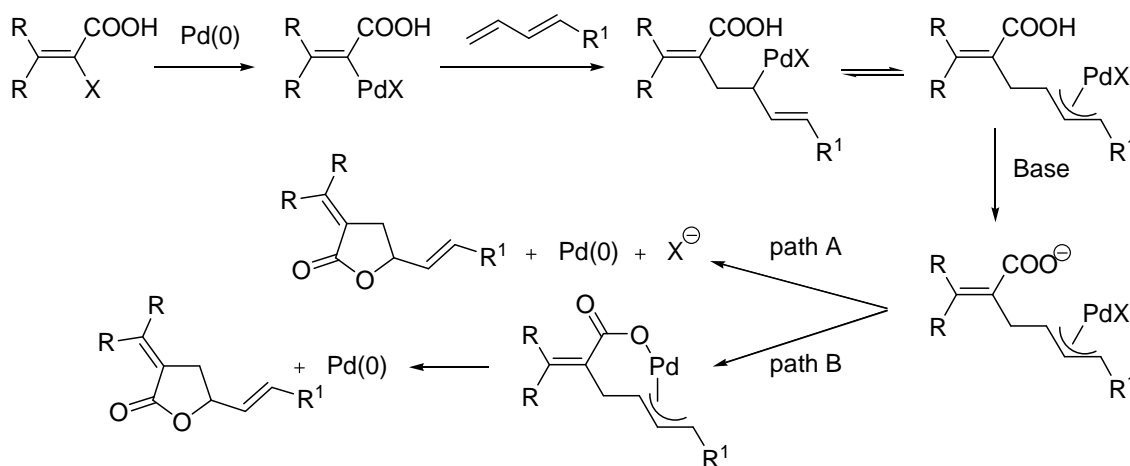

Scheme 48

3.4.2.2. Pd-catalyzed carbonylation of 3-iodohomoallylic alcohols

Pd(PPh₃)₄ catalyzed carbonylation of vinylic iodides bearing a suitably located alcohol group lead to α -alkylidene- γ -lactones through nucleophilic attack at the resulting acylpalladium intermediate. Yields ranging from 56 to 72% have been reported for secondary alcohols (Scheme 49).⁴¹

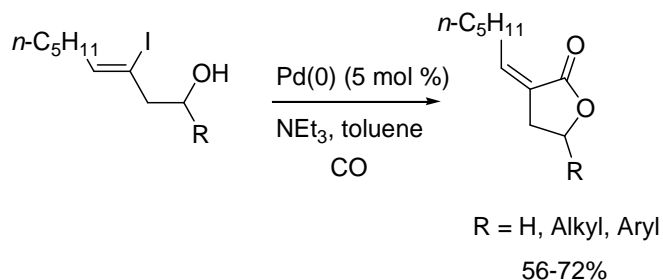

Scheme 49

3.4.3. Ti(II)-mediated cyclization of homopropargylic carbonates

Sato and co-workers have reported the synthesis of α -alkylidene- γ -lactones mediated with Ti(II) complexes (Scheme 50).⁴² According to the mechanism shown in Scheme 51, diisopropoxy(η^2 -propene)titanium generated from $\text{Ti}(\text{O}i\text{-Pr})_4$ and 2 equivalents of $i\text{-PrMgBr}$ undergoes replacement of propene by the acetylenic moiety of homopropargylic carbonate.

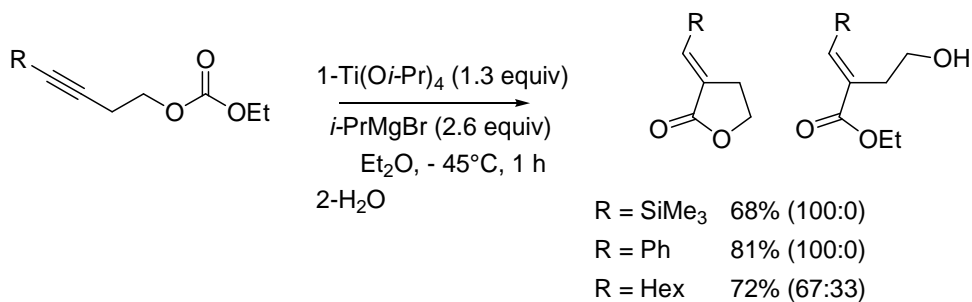

Scheme 50

Alkyne titanium, or titanacyclopentene intermediates lead to alkylidene lactones bearing an alkenyl titanium moiety through intramolecular nucleophilic substitution at the acyl group *via* path **a** and/or **b** (Scheme 51). Protonation leads to the target heterocycle.

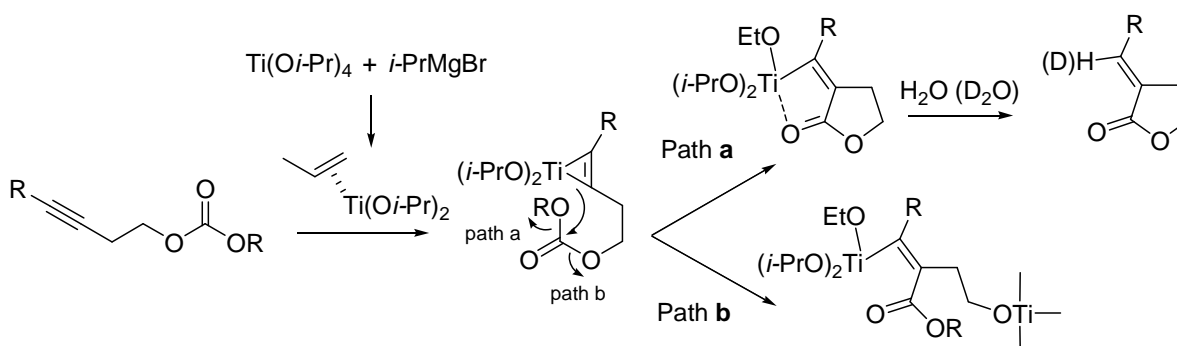

Scheme 51

3.4.4. [2+2+1] Cycloaddition leading to bicyclic α -alkylidene- γ -lactones and lactams

Bicyclic targets have been discarded from the main part of this review. However, [2+2+1] cycloaddition, which is a powerful tool for the construction of complex molecules, cannot be ignored.

Pauson-Khand cycloaddition has been applied by Krafft to functionalized enynes. Bicyclic alkylidene- γ -lactam was isolated in 73% yield, using catalytic $\text{Co}_4(\text{CO})_{12}$ in water (Scheme 52).⁴³

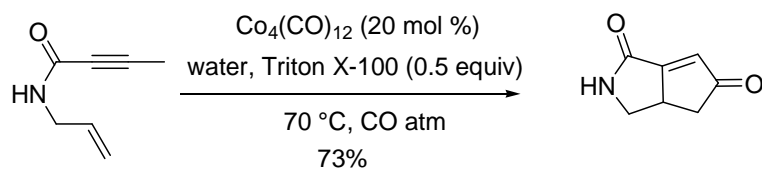

Scheme 52

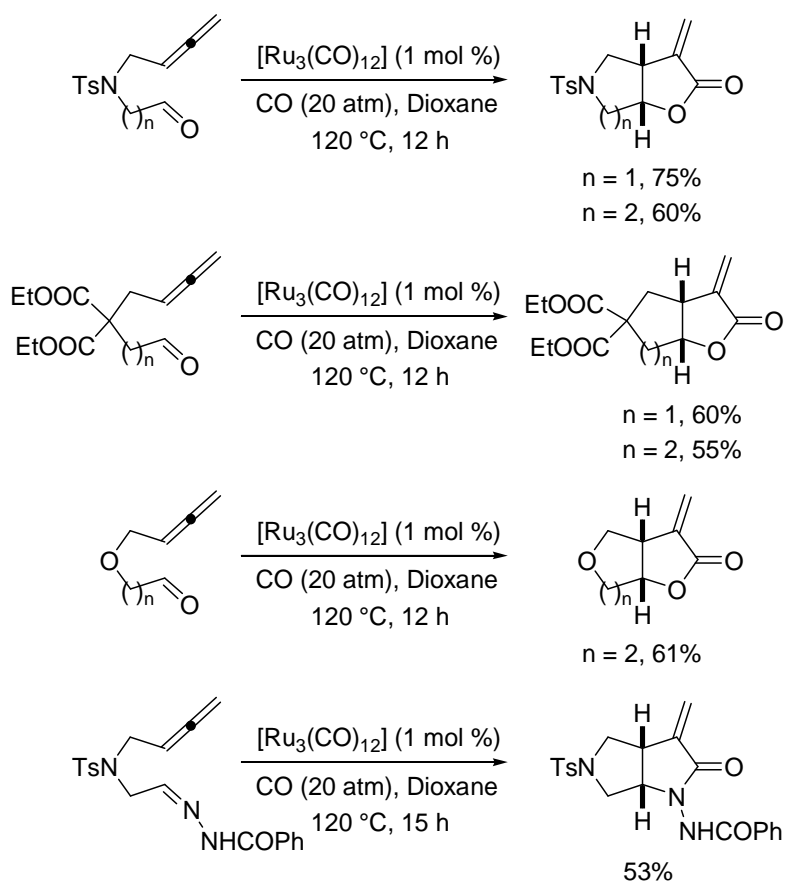

Scheme 53

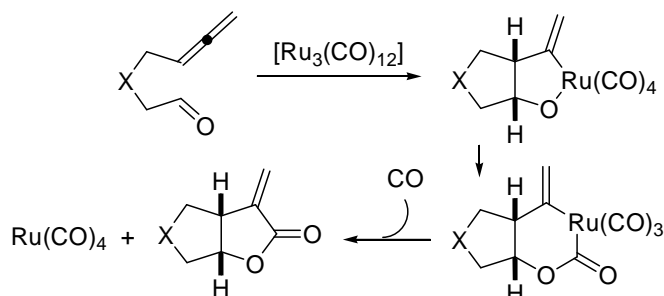

Scheme 54

The Ru (0)-catalyzed hetero-Pauson-Khand reaction was investigated by Kang.⁴⁴ High yields in bicyclic α -methylene- γ -lactones were obtained from a variety of allenic aldehydes (Scheme 53) at 120 °C under 20 atm CO pressure.

A plausible mechanism involving oxidative coupling, carbon monoxide insertion and reductive elimination is given in Scheme 54.

4. Conclusion

The goal of this review was to demonstrate that put together radical- and transition metal-mediated-cyclizations offer a mosaic of methodologies for the construction of both α -alkylidene- γ -lactones and γ -lactams. All through out the selected framework, we have tried to put in perspective, the similarities and/or complementarities of these approaches. It sounds evident that although some radical pathways remain to be explored, the transition metal chemistry displays a larger range of possibilities, and most importantly enables catalytic enantioselective syntheses. A few examples have now been recorded.

References

1. Morgan, E. D.; Wilson, I. D. In *Comprehensive Natural Products Chemistry*; Barton, D.; Nakanishi, K.; Meth-Cohn, O., Eds.; Pergamon: Oxford, 1999, Vol. 8, p. 308.
2. Hoffmann, H. M. R.; Rabe, J. *Angew. Chem. Int. Ed.* **1985**, *24*, 94.
3. (a) Janecki, T. In *Targets in Heterocyclic Systems: Organophosphorus Reagents as a Versatile Tool in the Synthesis of α -Alkylidene- γ -Butyrolactones and α -Alkylidene- γ -Butyrolactams*; Attanasi, O. A.; Spinelli, D., Eds.; Italian Society of Chemistry: Rome, 2006; Vol. 10, p. 301. (b) See also: Albrecht, A.; Koszok, J. F.; Modranka, J.; Rózsalski, M.; Krajewska, U.; Janecka, A.; Studzian, K.; Janecki, T. *Biorg. Med. Chem.* **2008**, *16*, 4872.
4. (a) Giese, B.; Kopping, B.; Gobel, T.; Dickhaut, J.; Thoma, G.; Kulicke, K. J.; Trach, F. *Organic Reactions* **1996**, *48*, 301. (b) Curran, D. P. In *Comprehensive Organic Synthesis*; Trost, B. M.; Fleming, I.; Semmelhack, M. F., Eds.; Pergamon: Oxford, 1991; Vol. 4, p. 779.
5. For general reviews on the synthesis of heterocyclic compounds *via* radical cyclization, see: (a) Bowman, W. R.; Fletcher, A.; Potts, G. B. S. *J. Chem. Soc., Perkin Trans. 1.* **2002**, *24*, 261. (b) Aldabbagh, F.; Bowman, W. R. *Contemp. Org. Synth.* **1997**, *4*, 261. (c) Majunbar, K. M.; Basu, P. K.; Mukhopadhyay, P. P. *Tetrahedron* **2004**, *60*, 6239, and previous references cited therein.
6. Bachi, M. D.; Bosch, E. *Tetrahedron Lett.* **1986**, *27*, 641.
7. (a) Jenkins, P. R.; Symons, M. C. R.; Booth, S. E.; Swain, C. J. *Tetrahedron Lett.* **1992**, *33*, 3543. (b) Goumans, T. P. M.; van Alem, K.; Lodder, G. *Eur. J. Org. Chem.* **2008**, 435.
8. Gill, B.; Pattenden, G.; Reynolds, S. J. *J. Chem. Soc., Perkin Trans. 1* **1994**, 369.
9. Lee, E.; Ko, S. B.; Jung, K. W. *Tetrahedron Lett.* **1989**, *30*, 827.
10. Branchi, B.; Galli, C.; Gentili, P. *Eur. J. Org. Chem.* **2002**, 2844.
11. Feray, L.; Bertrand, M. P. *Eur. J. Org. Chem.* **2008**, 3164.
12. (a) Curran, D. P.; Tamine, J. *J. Org. Chem.* **1991**, *56*, 2746. (b) Curran, D. P.; Chang, C.-T. *J. Org. Chem.* **1989**, *54*, 3140. (c) Musa, O.; Horner, J. H.; Newcomb, M. *J. Org. Chem.* **1999**, *64*, 1022. (d) De Raggi, E.; Gastaldi, S.; Surzur, J.-M.; Bertrand, M. P. *J. Org. Chem.* **1992**, *57*, 6118.
13. Wang, Z.; Lu, X. *Tetrahedron* **1995**, *51*, 2639.
14. (a) Mawson, S. D.; Routledge, A.; Weavers, R. T. *Tetrahedron* **1995**, *51*, 4665. (b) Mawson, S. D.; Weavers, R. T. *Tetrahedron* **1995**, *51*, 11257. (c) Haaima, G.; Hanton, L. R.; Lynch, M.-J.; Mawson, S. D.; Routledge, A.; Weavers, R. T. *Tetrahedron* **1994**, *50*, 2161.
15. (a) Sharma, G. V. M.; Krishnudu, K. *Tetrahedron Lett.* **1995**, *36*, 2661. (b) Sharma, G. V. M.; Krishnudu, K. *Tetrahedron: Asymmetry* **1999**, *10*, 869.
16. Cossy, J.; Ranaivosata, J.-L.; Bellosta, V. *Tetrahedron* **1996**, *52*, 629.
17. Mandal, P. K.; Maiti, G.; Roy, S. C. *J. Org. Chem.* **1998**, *63*, 2829.

18. (a) Tabatabaian, K.; Mamagkhani, M.; Navai-Dyva, T. *Russ. J. Org. Chem., Engl. Ed.* **2002**, *38*, 210. (b) Tabatabaian, K.; Mamagkhani, M.; Ghanadzadeh, A.; Riahi, A. *Mendeleev Commun.* **2006**, 33.
19. (a) Boffey, R. J.; Santagostino, M.; Whittingham, W. G.; Kilburn, J. D. *Chem. Commun.* **1998**, 1875. (b) Boffey, R. J.; Whittingham, W. G.; Kilburn, J. D. *J. Chem. Soc., Perkin Trans 1* **2001**, 487.
20. For selected recent examples, see: (a) Sibi, M. P.; Yang, Y.-H. *Synlett* **2008**, 83. (b) Sibi, M. P.; Petrovic, G.; Zimmerman, J. *J. Am. Chem. Soc.* **2005**, *127*, 2390. (c) Lee, S.; Kim, S. *Org. Lett.* **2008**, DOI: 10.1021/ol8017177. (d) Cho, D. H.; Jang, D. O. *Chem. Commun.* **2006**, 5045, and previous references cited therein.
21. Grigg, R.; Savic, V. *Chem. Commun.* **2000**, 2381.
22. Murray, T. F.; Samsel, E. G.; Varma, V.; Norton, J. R. *J. Am. Chem. Soc.* **1981**, *103*, 7520.
23. Kobayashi, Y.; Kamisaki, H.; Yanada, K.; Yanada, R.; Takemoto, Y. *Tetrahedron Lett.* **2005**, *46*, 7549.
24. (a) Ma, S.; Lu, X. *J. Org. Chem.* **1991**, *56*, 5120. (b) Zhu, G.; Lu, X. *Organometallics* **1995**, *14*, 4899.
25. (a) Zhu, G.; Lu, X. *Tetrahedron: Asymmetry* **1995**, *6*, 885. (b) Zhu, G.; Lu, X. *Tetrahedron: Asymmetry* **1995**, *6*, 1657. (c) Zhu, G.; Lu, X. *Tetrahedron: Asymmetry* **1996**, *7*, 1923. (d) Zhu, G.; Lu, X. *Tetrahedron Lett.* **1997**, *38*, 5213. For a review, see: (e) Lu, X.; Zhu, G.; Wang, Z.; Ma, S.; Ji, J.; Zhang, Z. *Pure & Appl. Chem.* **1997**, *69*, 553.
26. Xie, X.; Lu, X.; Xu, W. *J. Org. Chem.* **2001**, *66*, 6545.
27. Xie, X.; Lu, X. *Synlett* **2000**, 707.
28. (a) Jiang, H.; Ma, S.; Zhu, G.; Lu, X. *Tetrahedron* **1996**, *52*, 10945. (b) Zhu, G.; Lu, X. *Tetrahedron: Asymmetry* **1995**, *6*, 345. (c) Zhu, G.; Lu, X. *J. Org. Chem.* **1995**, *60*, 1160.
29. Yang, S.-R.; Jiang, H.-F.; Li, Y.-Q.; Chen, H.-J.; Xu, Y.-B. *Tetrahedron* **2008**, *64*, 2930.
30. (a) Zhao, L.; Lu, X.; Xu, W. *J. Org. Chem.* **2005**, *70*, 4059. (b) Xu, W.; Kong, A.; Lu, X. *J. Org. Chem.* **2006**, *71*, 3854. (c) Zhang, Q.; Lu, X. *J. Am. Chem. Soc.* **2000**, *122*, 7604.
31. Xie, X.; Lu, X. *Tetrahedron Lett.* **1999**, *40*, 8415.
32. (a) Zhu, G.; Tong, X.; Cheng, J.; Sun, Y.; Li, D.; Zhang, Z. *J. Org. Chem.* **2005**, *70*, 1712. (b) Song, J.; Shen, Q.; Xu, F.; Lu, X. *Org. Lett.* **2007**, *9*, 2947.
33. (a) Lei, A.; Waldkirch, J. P.; He, M.; Zhang, X. *Angew. Chem. Int. Ed.* **2002**, *41*, 4526, and previous references cited therein. (b) Tong, X.; Zhang, Z.; Zhang, X. *J. Am. Chem. Soc.* **2003**, *125*, 6370. (c) Tong, X.; Li, D.; Zhang, Z.; Zhang, X. *J. Am. Chem. Soc.* **2004**, *126*, 7601.
34. Jang, H.-Y.; Hughes, F. W.; Gong, H.; Zhang, J.; Brodbelt, J. S.; Krische, M. J. *J. Am. Chem. Soc.* **2005**, *127*, 6174.
35. Rhee, J. U.; Krische, M. J. *J. Am. Chem. Soc.* **2006**, *128*, 10674.
36. Mori, M.; Saito, N.; Tanaka, D.; Takimoto, M.; Sato, Y. *J. Am. Chem. Soc.* **2003**, *125*, 5606.
37. Charruault, L.; Michelet, V.; Genêt, J.-P. *Tetrahedron Lett.* **2002**, *43*, 4757.
38. Aggarwal, V. K.; Davies, P. W.; Schmidt, A. T. *Chem. Commun.* **2004**, 1232.
39. (a) Chen, M.-J.; Chang, S.-T.; Liu, R.-S. *Tetrahedron* **2000**, *56*, 5029. For the cyclization of tungsten- η^1 -alkynols, see: (b) Liang, K.-W.; Chandrasekharam, M.; Li, C.-L.; Liu, R. S. *J. Org. Chem.* **1998**, *63*, 7289. (c) Liang, K.-W.; Li, W.-T.; Peng, S.-M.; Wang, S.-L.; Liu, R.-S. *J. Am. Chem. Soc.* **1997**, *119*, 4404.
40. Gagnier, S. V.; Larock, R. C. *J. Org. Chem.* **2000**, *65*, 1525.
41. (a) Luo, F.-T.; Wang, M.-W.; Liu, Y.-S. *Heterocycles* **1996**, *43*, 2725. (b) Zhang, C.; Lu, X. *Tetrahedron Lett.* **1997**, *38*, 4331. For a previous report on a similar procedure, see: (c) Mori, M.; Washioka, Y.; Urayama, T.; Yoshiura, K.; Chiba, K.; Ban, Y. *J. Org. Chem.* **1983**, *48*, 4058.
42. Okamoto, S.; Kasatkin, A.; Zubaidha, P. K.; Sato, F. *J. Am. Chem. Soc.* **1996**, *118*, 2208.
43. Boñaga, L. V. R.; Wright, J. A.; Krafft, M. E. *Chem. Commun.* **2004**, 1746.
44. Kang, S.-K.; Kim, K.-J.; Hong, Y.-T. *Angew. Chem. Int. Ed.* **2002**, *41*, 1584.

THE REACTION OF CARBONYL COMPOUNDS AND NITRILES WITH TRIFLIC ANHYDRIDE. SYNTHESIS OF PYRIMIDINES, BENZOTHIAZINES, OXAZOLES AND TRIAZINES

Roberto Martínez-Álvarez* and Antonio Herrera

Departamento de Química Orgánica, Facultad de Ciencias Químicas, Universidad Complutense, E-28040 Madrid, Spain (e-mail: rma@quim.ucm.es)

Abstract. *One-pot reactions between carbonyl compounds and nitriles in the presence of trifluoromethanesulfonic (triflic) anhydride afford a wide variety of heterocyclic compounds from readily available starting materials. Thus, substituted pyrimidines, benzothiazines, oxazoles and triazines can be prepared in good yields. The mechanisms and intermediates of the different reactions are reported.*

Contents

1. Introduction
 - 1.1. Triflic anhydride and vinyl triflates
 2. Initial investigations
 - 2.1. The reaction of vinyl triflates and nitriles. Mechanism of the reaction
 3. Synthesis of substituted pyrimidines
 - 3.1. The reaction of aldehydes and ketones in the presence of triflic anhydride
 - 3.2. Regioselectivity in the reaction of aliphatic ketones
 - 3.3. Synthesis of halo- and alkoxy pyrimidines
 - 3.4. Synthesis of substituted benzoquinazolines and related compounds
 - 3.5. Cyclobutapyrimidines and pyrimidine *ortho*-quinodimethanes in the Diels-Alder reaction
 - 3.6. The special reactivity of benzyl cyanides
 - 3.7. The use of methyl thiocyanate. Synthesis of functionalized pyrimidines
 - 3.8. Synthesis of heterocycles fused pyrimidines
 4. The reaction with carbonyl compounds containing sulfur atoms
 - 4.1. The reaction of thioesters with nitriles and triflic anhydride
 - 4.2. Stereoselective synthesis of substituted 1,3-benzothiazines
 - 4.3. Synthesis of 1,3-oxazoles
 5. Synthesis of 2,4,6-trisubstituted 1,3,5-triazines
 6. Conclusions
- Acknowledgments
- References

1. Introduction

Many years ago, the introduction of perfluoroalkanesulfonic acids and their derivatives, particularly of fluorosulfonic acid,¹ trifluoromethanesulfonic acid (triflic acid)² and nonafluorobutanesulfonic acid³ led to the preparation of their respective esters referred as fluorosulfates (**1**), triflates (**2**) and nonaflates (**3**) (Scheme 1). Conductivity measurements show that these acids are very strong Brønsted acids, stronger than

sulfuric and even perchloric acid.⁴ Hence, perfluoroalkanesulfonates are exceptionally effective leaving groups, exceeded only by nitrogen molecule from diazonium salts or PhI in iodonium salts.⁵ Detailed studies establish triflates to be some 2×10^4 to 2×10^5 times more reactive than comparable tosylates.⁶ Hammett substituent constants for the triflate group show that OTf (OSO_2CF_3) is one of the strongest inductive electron withdrawing group.⁷

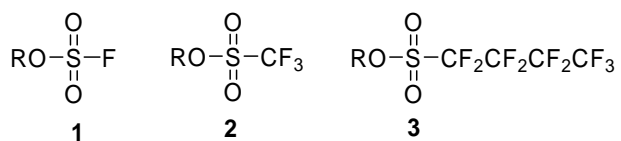

Scheme 1

1.1. Triflic anhydride and vinyl triflates

Triflic acid⁸ and its rare-earth metal salts⁹ have found many applications in the field of organic synthesis. In addition, trifluoromethanesulfonic anhydride (Tf_2O , triflic anhydride) has also been employed broadly in synthetic and mechanistic organic chemistry, specially for the preparation of triflates from various compounds.¹⁰ Moreover, triflic anhydride is able to induce or catalyze many chemical transformations.¹¹ Vinyl triflates were first reported in 1969¹² and have been used primarily for the direct solvolytic generation of vinyl cations.¹³ Vinyl triflates have played a key role in establishing the exact geometry of vinyl cations and were also employed to demonstrate hydride, alkyl and aryl migrations in vinyl cations.¹³ Useful preparative procedures have involved vinylic displacements.^{10,14} Moreover, many synthetic procedures based on the cross coupling reactions of vinyl triflates have been recently reported; significant examples are given in the References section.¹⁵

2. Initial investigations

2.1. The reaction of vinyl triflates and nitriles. Mechanism of the reaction

A few years ago, we explored the synthetic applications of vinyl triflates, prepared from aldehydes and ketones, because the triflate group can be easily removed by different nucleophiles under mild conditions.¹⁶ Using this approach, we planned to synthesize enamides¹⁷ from vinyl triflates. We expected that the reaction of 1-phenylvinyltriflate (**4**) with propanenitrile would afford, after hydrolysis, the corresponding enamide **7** derived from the nucleophilic attack of the nitrogen atom of the nitrile at the vinyl cation **5** generated from **4** by heating (Scheme 2).

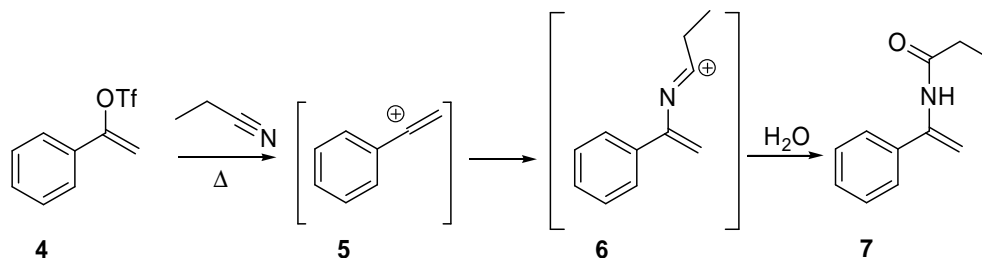

Scheme 2

We did not find the expected vinyl amide; a substituted pyrimidine (**8**) was produced instead in very good yield (Scheme 3).¹⁸

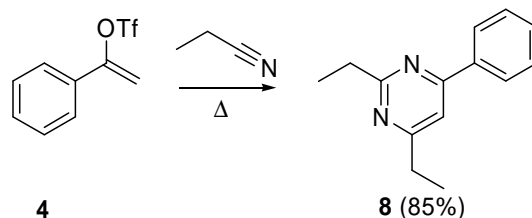

Scheme 3

This product was apparently formed from a dimerization of the nitrile with incorporation of the moiety of the starting triflate. When triflate **9** (isomeric mixture *Z/E* 72:28) reacted with acetonitrile, two isomeric pyrimidines **10** and **11** were obtained (Scheme 4).¹⁸

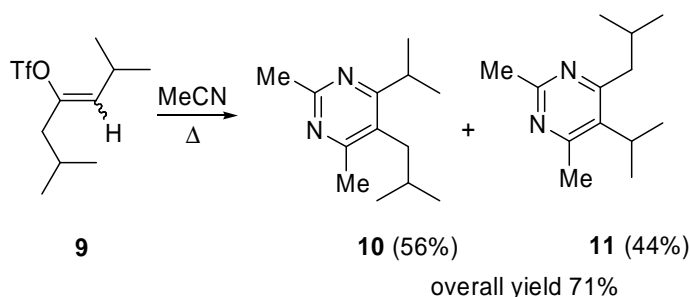

Scheme 4

To explain these products, we proposed a mechanism (Scheme 5) in which the first step involves an elimination of triflic acid from the vinyl triflate **9** to give alkyne **12**. The nitrile acts as a weak base which is protonated by the acid. Subsequent protonation of the triple bond generates two isomeric vinyl cations **13** and **14**. Nucleophilic attack by the nitrogen atom of the nitrile forms immonium ions **15** and **16**. These ions are then attacked by a second molecule of nitrile. Finally, the elimination of a proton and a cyclization process produce the pyrimidines **10** and **11**.

To test this proposal, we carried out the reaction using an alkyne intermediate as starting material instead of the vinyl triflate in propanenitrile (Scheme 6). We obtained the same pyrimidine **8** when phenylacetylene and propanenitrile were heated in the presence of triflic acid.¹⁹

These reactions represent a new one-pot synthetic approach to tri- and tetrasubstituted alkyl- and arylpyrimidines. Alkyl- and arylpyrimidines are otherwise prepared by tedious and time consuming procedures involving several steps.²⁰ Many of the synthetic routes to prepare these azaheterocycles are based on the condensation of amines and carbonyl compounds.²¹ One-pot preparations of pyrimidines have been recently reported that are based on the reaction of ketones with amides that are activated by pyridine and triflic anhydride.^{22,23} Our method, either from vinyl triflates which can be easily prepared from ketones or from alkynes, permits the synthesis of substituted pyrimidines. From the groups attached to the pyrimidine framework, the moieties brought by the reactants can be easily traced (Scheme 7).

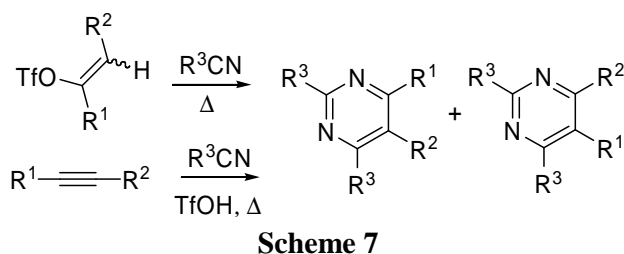
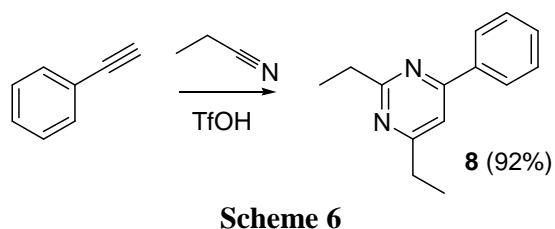
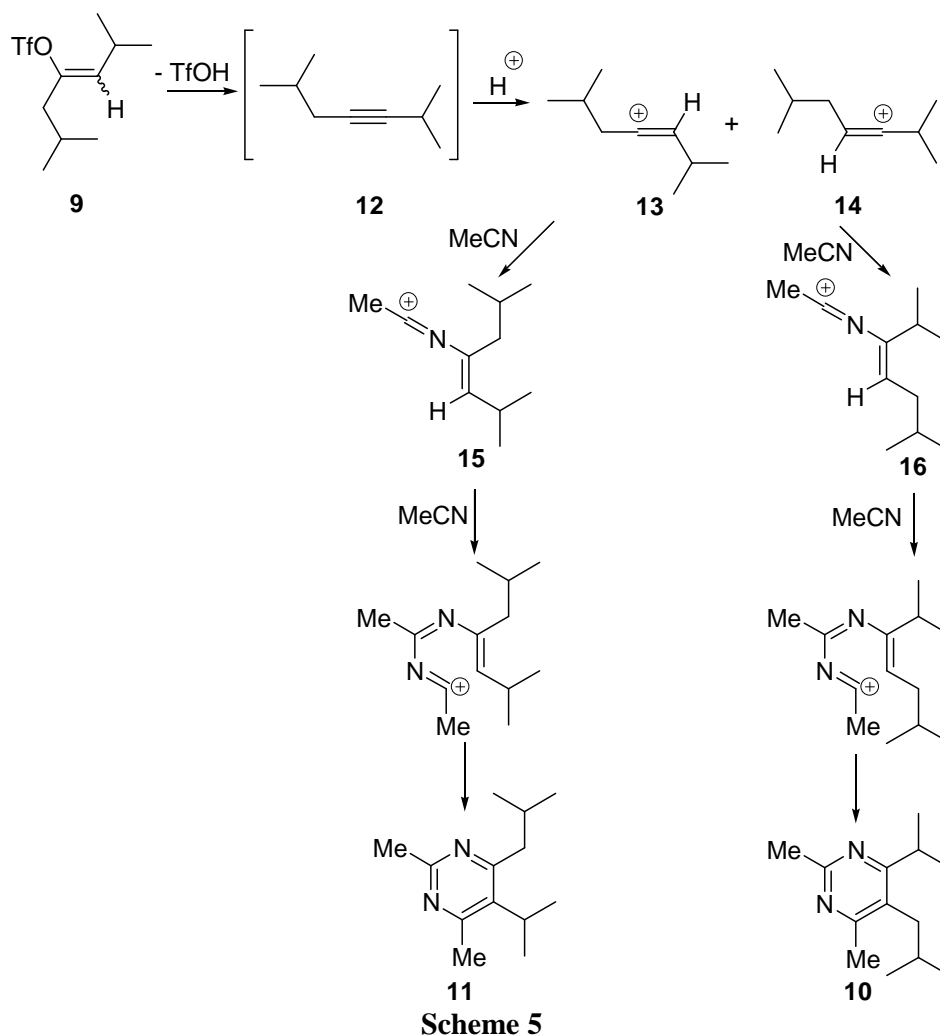

3. Synthesis of substituted pyrimidines

3.1. The reaction of aldehydes and ketones in the presence of triflic anhydride

In order to extend the findings summarized in Scheme 7, we replaced the vinyl triflates or alkynes with ketones which are more readily available. The reaction of ketones was therefore carried out with nitriles in

the presence of triflic anhydride. Carbonyl compounds react with triflic anhydride to give products having different structure and stereochemistry.²⁴ The reaction of ketones with triflic anhydride to form vinyl triflates is well-known,^{10a} however, the reaction of ketones with nitriles and Tf₂O afforded tetrasubstituted pyrimidines in good yields.²⁵ The first step of the proposed mechanism (Scheme 8) for this process involves the formation of a triflyloxycarbenium ion **17** from the electrophilic attack of the sulfur atom of Tf₂O at the carbonyl moiety. In the absence of nitrile and depending on the structure of the starting carbonyl compound and on the reaction conditions, different substances such as vinyl triflates **18** and *gem*-bistriflates **19** are obtained. When the reaction is carried out in the presence of nitriles, pyrimidines are formed in good yields. This unambiguously proves that the reaction proceeds *via* a triflyloxycarbenium ion **17**. This proposed intermediate is trapped by consecutive nucleophilic attacks by the nitrile to form two nitrilium-immonium ions (**20**, **21**). Subsequent proton elimination and cyclization process afford the corresponding pyrimidine. This mechanism is supported by the fact that the reaction only takes place when equimolecular amounts of Tf₂O and ketone are used. This indicates that triflic anhydride acts as reactant and not as a catalyst. Ketones, bearing at least one alpha hydrogen atom, easily react to form tetrasubstituted pyrimidines in very good yields. The reaction can be carried out at room temperature in solvents such as chloroform or dichloromethane as well as pentane and no special preventive measures must be taken.

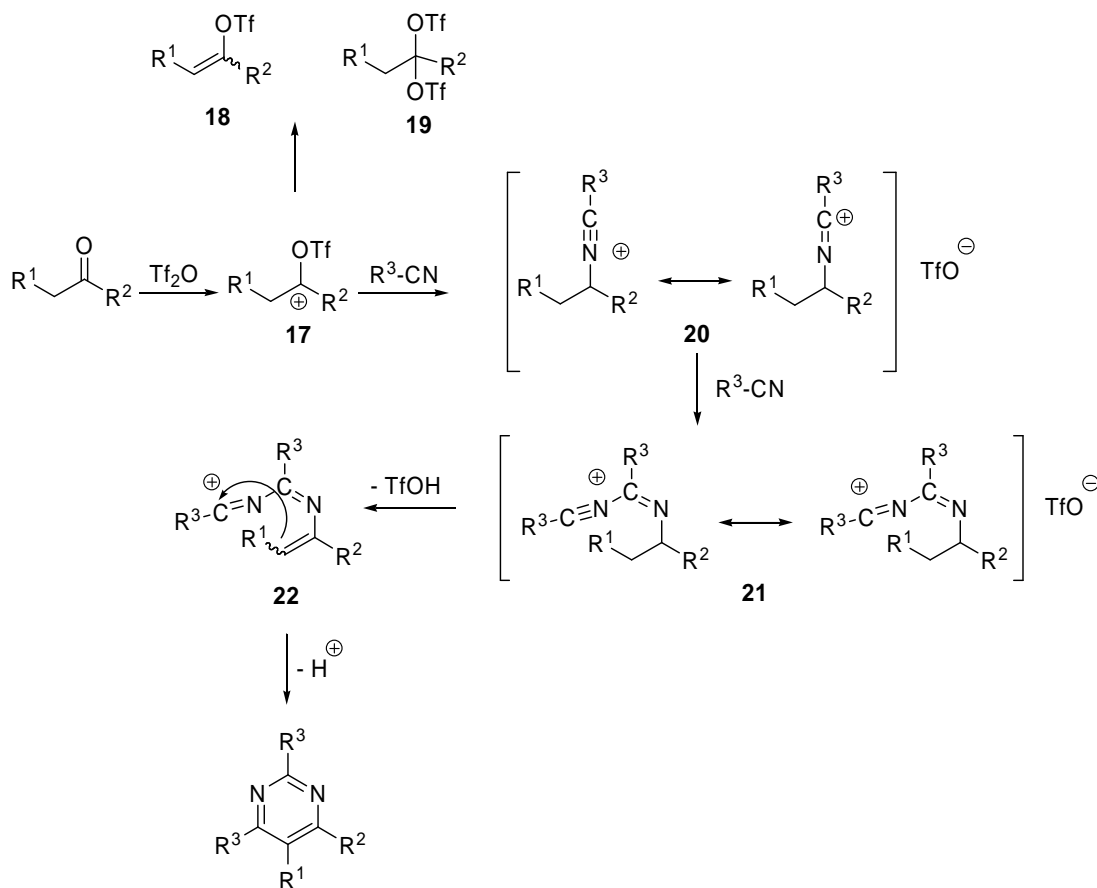

Scheme 8

In contrast, aldehydes are slower to react than ketones due to the relative instability of the corresponding triflyloxycarbenium ion, affording pyrimidines in lower yield.²⁶ We are currently studying

this reaction using UF-NMR in order to determine all the intermediates involved and the kinetic parameters of the process.²⁷ Immonium ions such as **20** and **21** are also postulated as intermediates in the condensation of nitriles and amides activated by 2-chloropyridine and triflic anhydride.^{23a}

Table 1. Representative examples of the reaction of ketones and aldehydes with nitriles in the presence of Tf₂O.

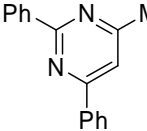
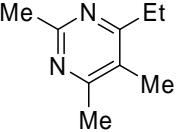
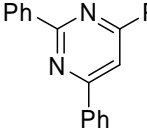
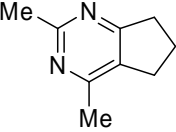
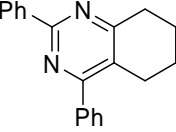
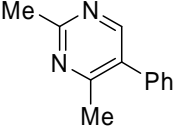
Carbonyl compound	Nitrile	Pyrimidine	Yield (%)
Acetone	PhCN		17
Diethylketone	MeCN		90
Acetophenone	PhCN		90
Cyclopentanone	MeCN		85
Cyclohexanone	MeCN		87
Phenylacetaldehyde	MeCN		23

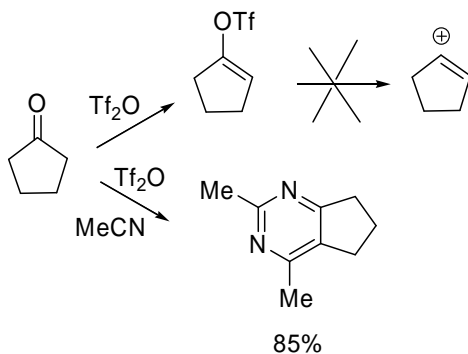

Scheme 9

As additional support for this proposed mechanism, we point out that some vinyl triflates formed from ketones and aldehydes are unable to generate the corresponding vinyl cations under the reaction conditions.¹³

Thus, cyclopentenyl triflate and primary vinyl triflates undergo solvolysis *via* a sulfur oxygen bond cleavage without formation of the expected vinyl cations. However, cyclopentanone and phenylacetaldehyde (Scheme 9 and Table 1) react with nitriles and Tf_2O to form pyrimidines.^{25,26} These data rule out the possibility that vinyl triflates or vinyl cations are intermediates in the proposed mechanism.

Among the pyrimidines we prepared, the di-*tert*-butylpyrimidines,²⁸ obtained using pivalonitrile, have pK_a values that make them useful as non-nucleophilic hindered bases²⁹ in situations where strong acids are formed as by-products (Scheme 10).

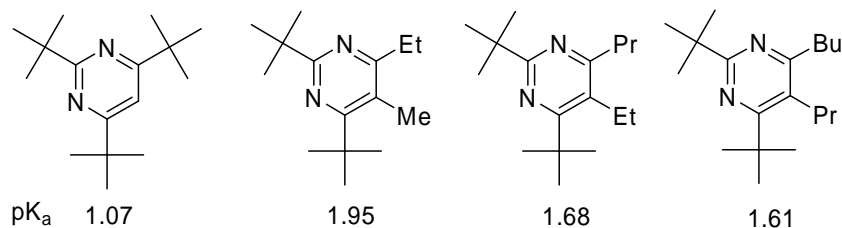

Scheme 10

The reaction of alkyl aryl ketones with nitriles in the presence of Tf_2O fails in the case of aromatic heterocyclic ketones. Thus, the reaction of 1-(1*H*-pyrrol-2-yl)ethanone with acetonitrile led to *N*-triflyl-substituted pyrrole salts due to the electrophilic attack of Tf_2O at the heterocyclic nitrogen atom. In order to prevent this side reaction, it is necessary to initially protect the nitrogen atom by forming previously its *N*-tosyl derivative.³⁰ This compound reacts with a nitrile in the presence of Tf_2O to form the corresponding substituted *N*-tosylpyrimidine, which, after basic hydrolysis, affords the free base.³¹ The *N*-tosylpyrrolidones react under the same conditions to form the corresponding *N*-tosylpyrrolopyrimidines (Scheme 11).

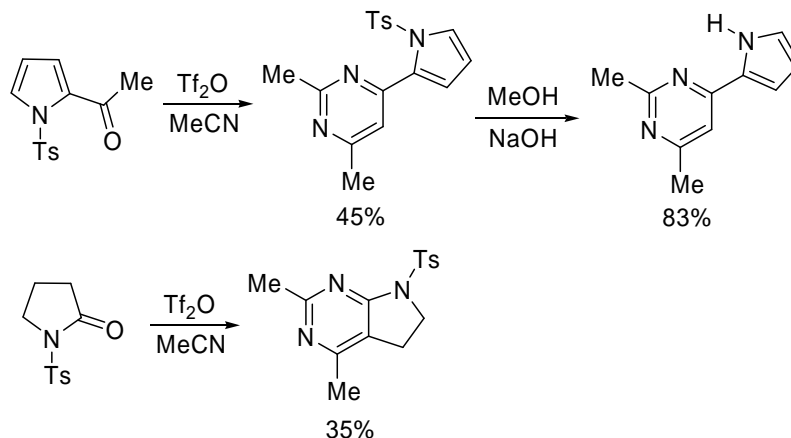

Scheme 11

This general procedure permits the easy preparation of a wide variety of alkyl-, aryl- and cycloalkane-fused pyrimidines. Several 5,6-dialkyl-2,4-diarylpyrimidines were prepared and their electron-impact (EI) mass spectra investigated. The benzylic cleavage of the alkyl chains together with an important McLafferty rearrangement (with hydrogen migration to the nitrogen atom) were the main fragmentations observed. The 5-methyl- and 6-methylsubstituted 2,4-diarylpyrimidines exhibit different spectrometric behaviours that allow them to be distinguished.³² On the other hand, the mass spectrometric cleavage of the cycloalkane-

fused pyrimidines depends strongly on the alkyl ring size and on the substituents attached to this ring. Thus, while cyclobutapyrimidines undergo consecutive elimination of two nitrile molecules, pyrimidines having larger fused rings fragment by ring opening with loss of alkyl rings.³³

3.2. Regioselectivity in the reaction of aliphatic ketones

When the reactions of asymmetric ketones were studied, the structures and ratio of the products indicate that the reaction is highly regioselective. Thus, the reaction of 2-ketones such as 2-heptanone (**23**) with benzonitrile produces only the corresponding 4-methylpyrimidine (**24**). However, from 3-ketones, the regioselectivity depends on the length of the alkyl residue attached at the carbonyl group. For 3-hexanone (**25**), the slight difference in chain lengths result in a product mixture (**26**, **27**), while for 3-octanone (**28**) the dissimilarity of the alkyl chain length induces the formation of an exclusive product (**29**) (Scheme 12).³⁴

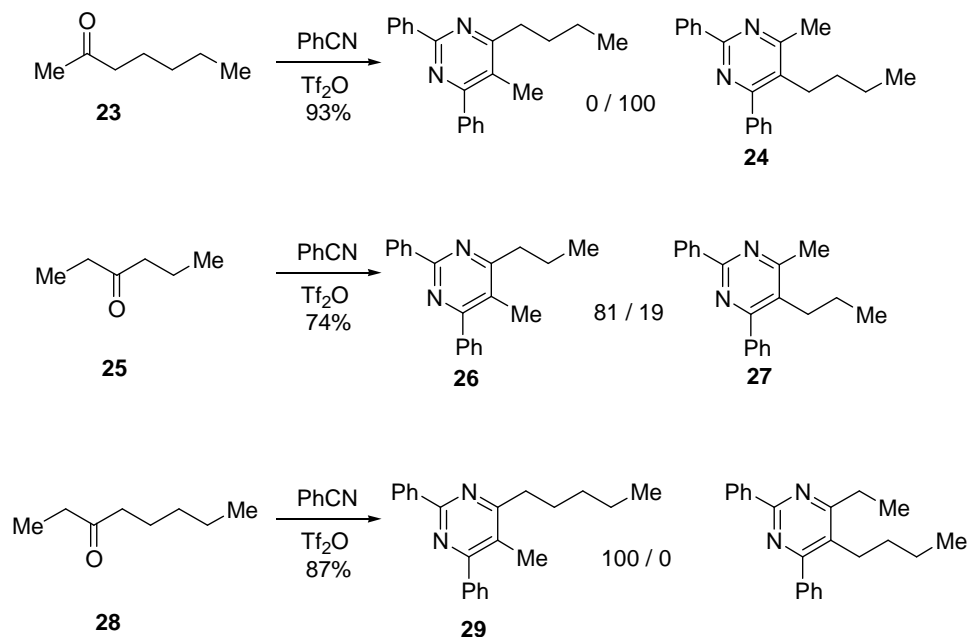

Scheme 12

These results show that the selectivity of the process is completely controlled by small variations in the alkyl groups attached to the carbonyl group. A more detailed observation of the general mechanism for the synthesis of pyrimidines from alkyl ketones (Scheme 8) could explain the reported results. The theoretical values of the heat of formation of *E/Z* olefinic intermediates such as **22** (Scheme 8) agree with the results obtained and permit a rational explanation for the regioselectivity found.³⁴

3.3. Synthesis of halo- and alkoxy-substituted pyrimidines

Using the above approach, α -haloketones react with nitriles and triflic anhydride to form 4-halo-pyrimidines.³⁵ Haloketones bearing chloro or bromo atoms gave good yields while iodoketones afford pyrimidines in lower yields. Following the same strategy, the reaction of aliphatic esters under the same conditions produces 4-alkoxy and 4-aryloxy-substituted pyrimidines (Scheme 13).³⁶ The proposed mechanisms for both reactions involves the same pathway postulated for the reaction of ketones (see Scheme 8).

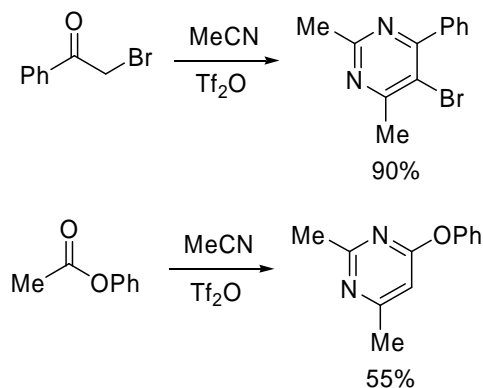

Scheme 13

In contrast to the results of the reaction of aliphatic esters, phenylacetic esters form substituted isoquinolines in medium to good yields (Scheme 14). The formation of these unexpected products can be explained with a shortened reaction path. The initial intermediate triflyloxycarbenium ion is attacked by a nitrile molecule to give a nitrilium-immonium ion. In this case, the structure of the cationic intermediate favours a cyclization process instead of a second attack by another nitrile molecule. The cyclization process leads, after loss of a proton and elimination of triflic acid, to isoquinolines.³⁷

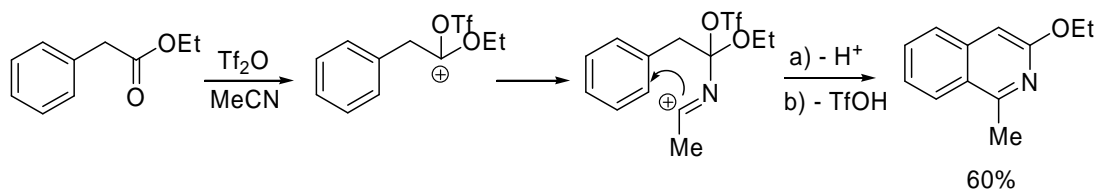

Scheme 14

3.4. Synthesis of substituted benzoquinazolines and related compounds

Among the pyrimidines, one of the most prominent are the benzoquinazolines. In the past, the construction of the quinazoline moiety has involved cyclization of appropriate benzenes whose preparations are not always easy. Recently, two convenient procedures were reported from anilides³⁸ and from naphthylamines.³⁹ We have found that the reaction of 1- and 2-tetralone with nitriles in the presence of triflic anhydride affords substituted dihydrobenzo[*h*]quinazolines (**30**) and substituted dihydrobenzo[*f*]quinazolines (**31**), respectively (Scheme 15).⁴⁰ The oxidation of compounds **30** and **31** with of 2,3-dichloro-5,6-dicyano-benzoquinone (DDQ) affords the corresponding substituted benzoquinazolines (**32** and **33**) (Scheme 15). With two different positions alpha to the carbonyl group on 2-tetralone, one can envisage the formation of two possible isomeric dihydrobenzo[*f*]- and dihydrobenzo[*g*]quinazolines. In fact, the exclusive formation of quinazolines **31** further demonstrates the regioselectivity of this process. When 2,4-dibenzylsubstituted dihydrobenzoquinazolines (**34**) react with DDQ, two different products are obtained depending on the temperature of reaction. Thus, if the reaction is carried out in refluxing *ortho*-dichlorobenzene (ODCB), both methylene groups are oxidized; however, when the reaction is carried out in refluxing toluene, only the methylene attached at the C4 position reacts to form monocarbonyl compounds. In this case, products derived from aromatization are not observed.

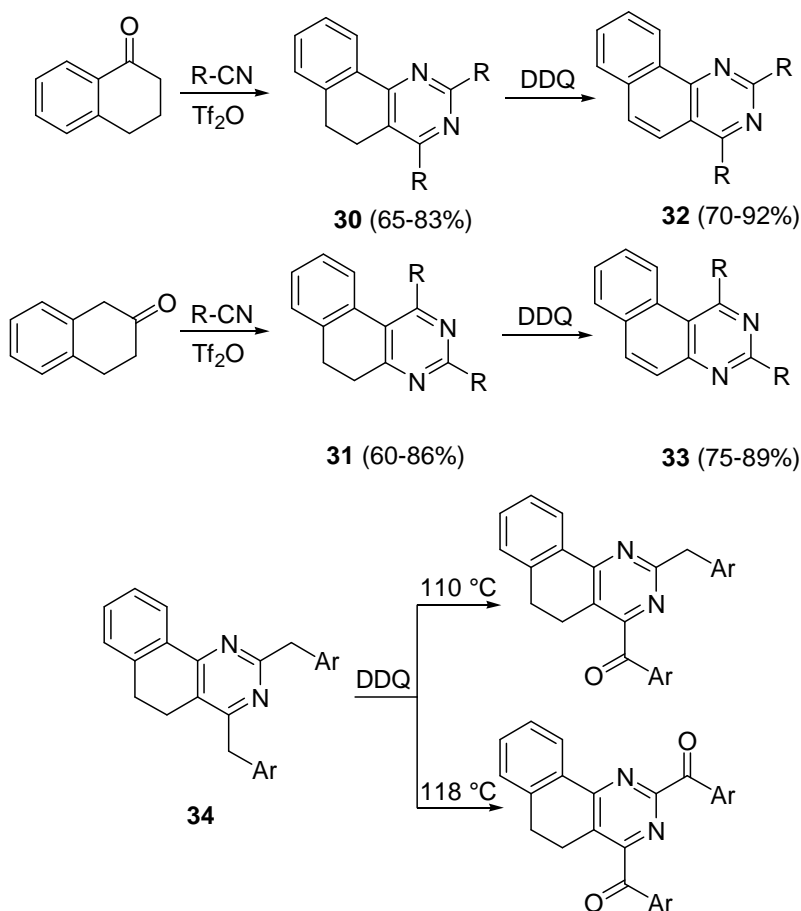

The use of 1-benzosuberone permits easy access to 2,4-disubstituted benzocycloheptapyrimidines (**35**) in good yields (Scheme 16).⁴¹ Members of this class of compounds have important pharmacological properties.⁴²

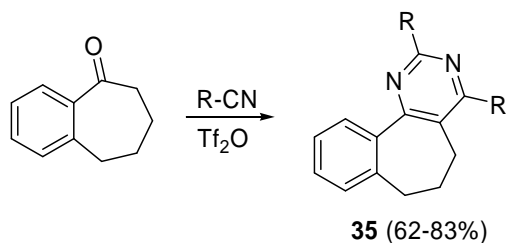

3.5. Cyclobutapyrimidines and pyrimidine *ortho*-quinodimethanes in the Diels-Alder reaction

Following the general scheme above, the reaction of cyclobutanone with nitriles affords the corresponding substituted cyclobutapyrimidines (**36**). Compounds **36** are obtained in moderate yields due to competitive aldol condensation of the cyclobutanone. These compounds are excellent precursors for the *in situ* generation of the extremely reactive pyrimidine dienes (*ortho*-quinodimethanes) by thermolysis in *ortho*-dichlorobenzene (ODCB) at 180 °C which are trapped with different dienophiles in a classical Diels-Alder (DA) reaction (Scheme 17).⁴³

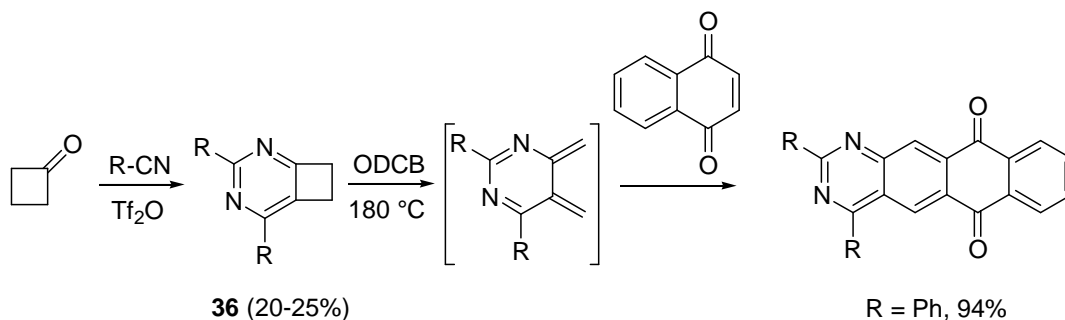

Scheme 17

The stereochemistry of the DA reaction of these pyrimidine *ortho*-quinodimethanes (*o*-QDMs) was investigated. Thus, while diethyl maleate formed a mixture of *cis* and *trans* adducts, diethyl fumarate gave only the *trans*-cycloadduct. The reaction with methyl acetylenedicarboxylate formed a mixture of dihydro and quinazoline derivatives. The high temperature at which the reaction takes place causes the aromatization of the initially formed dihydrocompound (Scheme 18).⁴⁴

Pyrimidine *o*-QDMs also react with non-classical dienophiles such as C₆₀ fullerene (Scheme 19). These adducts were used to determine thermodynamic parameters of some dynamic processes such as intramolecular boat-to-boat interconversion of the cyclohexene moiety. The Scheme 19 shows the ¹H NMR spectra of the methylene protons of cycloadduct **37** at various temperatures. At -15 °C the ring interconversion is frozen and two AB overlapped proton systems can be observed. The coalescence temperature and the ΔG^\ddagger values show a remarkable dependence on the nature of the substitution on the pyrimidine ring. The molecular geometry of some cycloadducts optimized at the semiempirical PM3 level predicts a structure in which the cyclohexene ring adopts a boat conformation, thus confirming the C₅ symmetry observed in the NMR spectra.⁴⁵

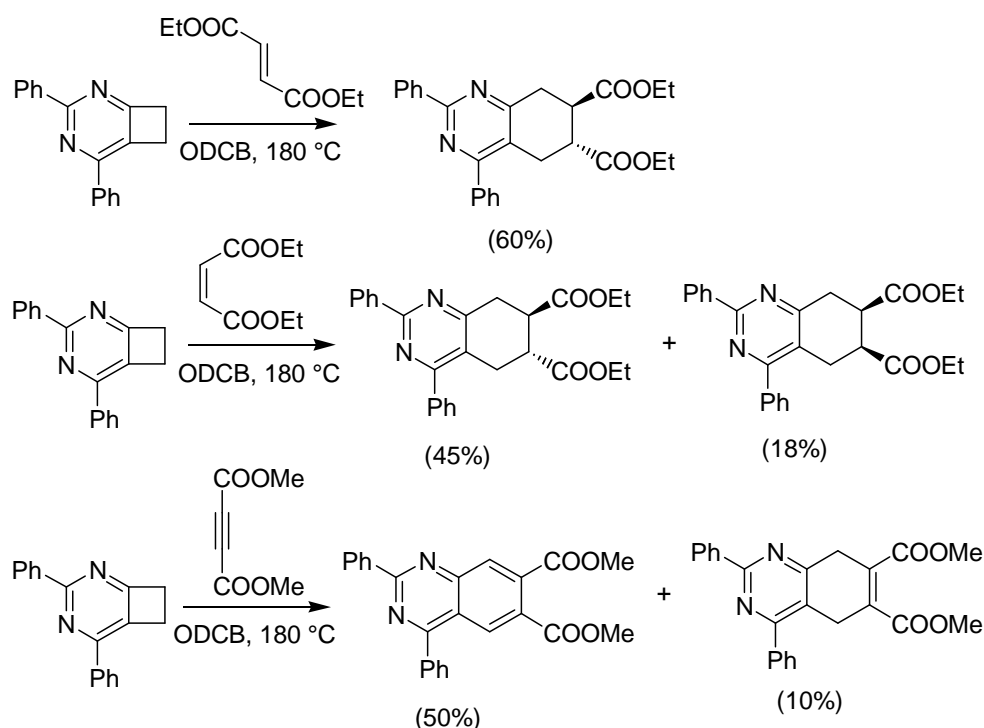

Scheme 18

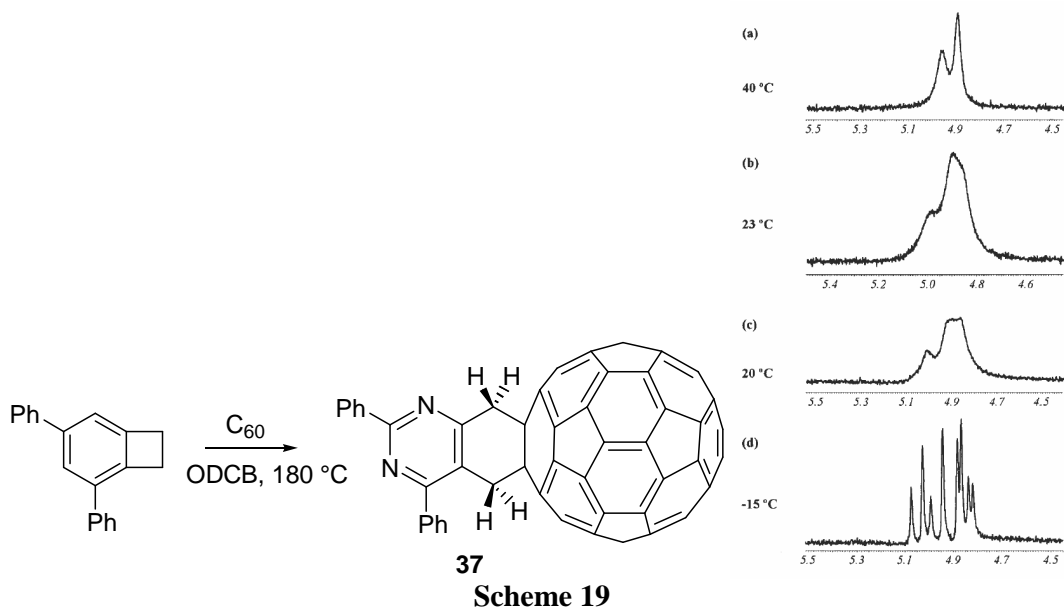

3.6. The special reactivity of benzylic cyanides

Benzylic nitriles yield an unusual variety of products when treated with ketones and triflic anhydride. When phenylacetonitrile reacts with ketones, such as cyclopentanone, the corresponding benzyl substituted pyrimidines are easily formed. We use this ketone as a representative example since its vinyl triflate cannot produce the corresponding vinyl cation (see Scheme 9) and this lack of reactivity rules out other concomitant mechanisms. However, if the benzylic nitrile has two or more methoxy substituents, two new compounds are obtained together with a small amount of the expected dibenzyl substituted pyrimidine (DBSP) (Scheme 20).⁴⁶

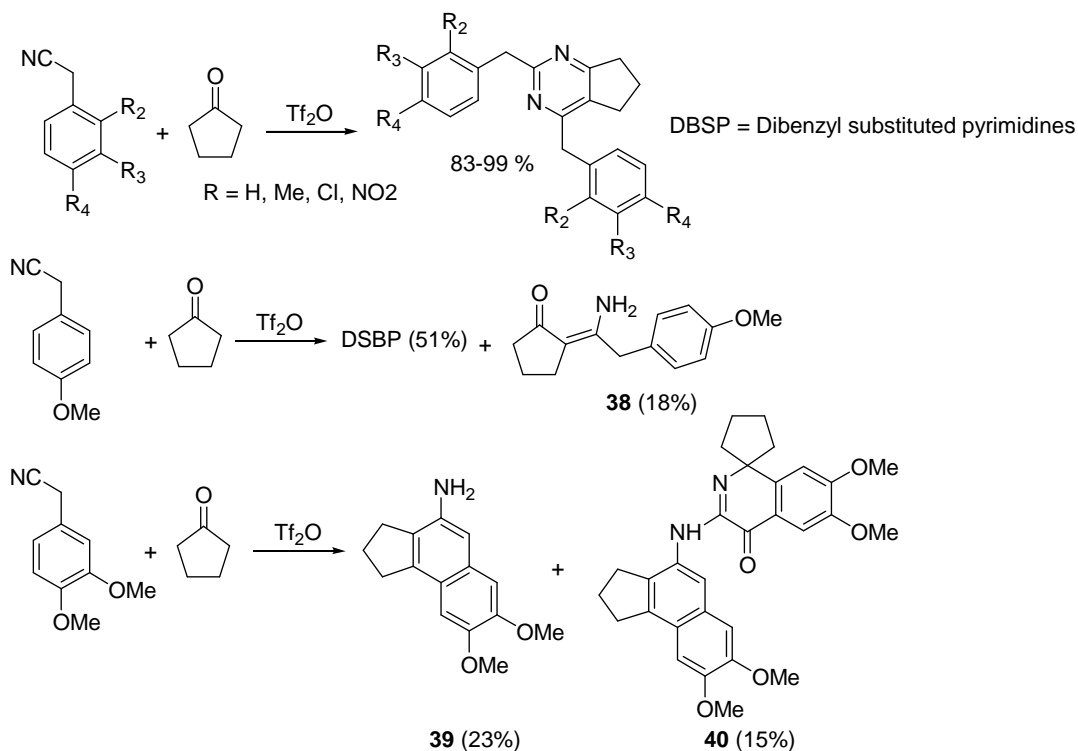

The amount of these unexpected substances increases with the number of methoxy substituents attached to the nitrile. The reaction of triflic anhydride and benzyl nitriles without ketones should lead to afford non-isolable complexes. The electronic nature of the substituents attached to the phenyl ring controls the stability of this complex. Electron acceptor groups prevent the formation of the complex affording pyrimidines as final products. In contrast, methoxy groups lead to a stabilized complex which reacts with cyclopentanone to form the unexpected compounds **38** and **39**. Compound **39** was obtained together with small amounts of an intriguing compound **40** whose structure was determined by X ray analysis (Figure 1). It is clear that the number of methoxy groups modulates the pathway of the reaction.

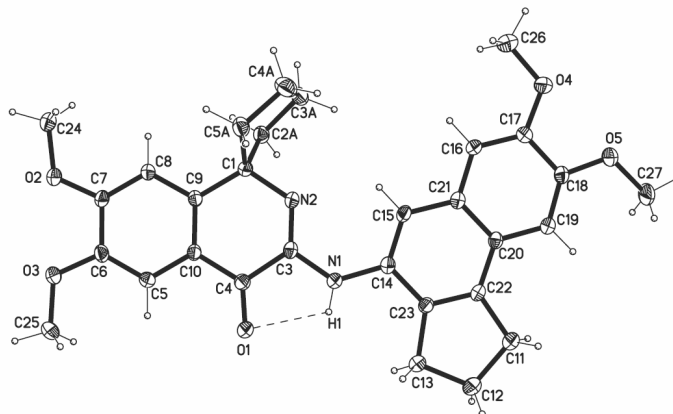

Figure 1

The molecule **40** is almost coplanar whereas the spirocyclopentane ring possesses an envelope conformation.⁴⁷

3.7. The use of methylthiocyanate. Synthesis of functionalized pyrimidines

Strategies for syntheses of particular pyrimidines require the incorporation of functional groups into the pyrimidine moiety that can be removed or transformed. Methylthio groups are easy to incorporate by using methylthiocyanate as nitrile and they can be also modified to a remarkable number of other functional groups.

The reaction of aliphatic, cyclic or aromatic ketones with triflic anhydride in the presence of methylthiocyanate affords the corresponding 2,4-bis(methylthio) substituted pyrimidines (**41**).⁴⁸ Nucleophilic displacement of the methylthio groups requires harsh conditions.²⁰ However, methylthio groups can be easily oxidized to methylsulfonyl groups which are much better leaving groups. Sulfones (**42**) react under normal conditions to give access to a variety of substituted pyrimidines (Scheme 21).⁴⁸

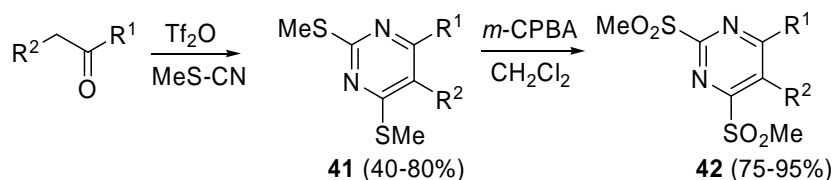

Scheme 21

Usually, the substitution of either MeSO₂ or MeS groups at C4 takes place faster than at C2, making it possible to displace these groups step by step. This permits the introduction of two different nucleophiles at these positions.

The reaction of disulfones **42** with sodium methoxide in methanol produces the dimethoxypyrimidines **43** which can be hydrolyzed in hydrochloric acid medium to form uracils **45**. These same uracils **45** can also be obtained by basic hydrolysis of disulfones. The nucleophilic displacement of both methylsulfonyl groups with tetrabutylammonium cyanide forms 2,4-dicyanopyrimidines **44**. Aminosulfones **46** are obtained by nucleophilic substitution of the methylsulfonyl group at C4 position with ammonia at room temperature. The use of ammonium hydroxide and a higher temperature permits the preparation of the diamino derivatives **47**. Aminomethoxy substituted pyrimidines **48** can be prepared from aminosulfones **46** by reaction with sodium methoxide (Scheme 22).

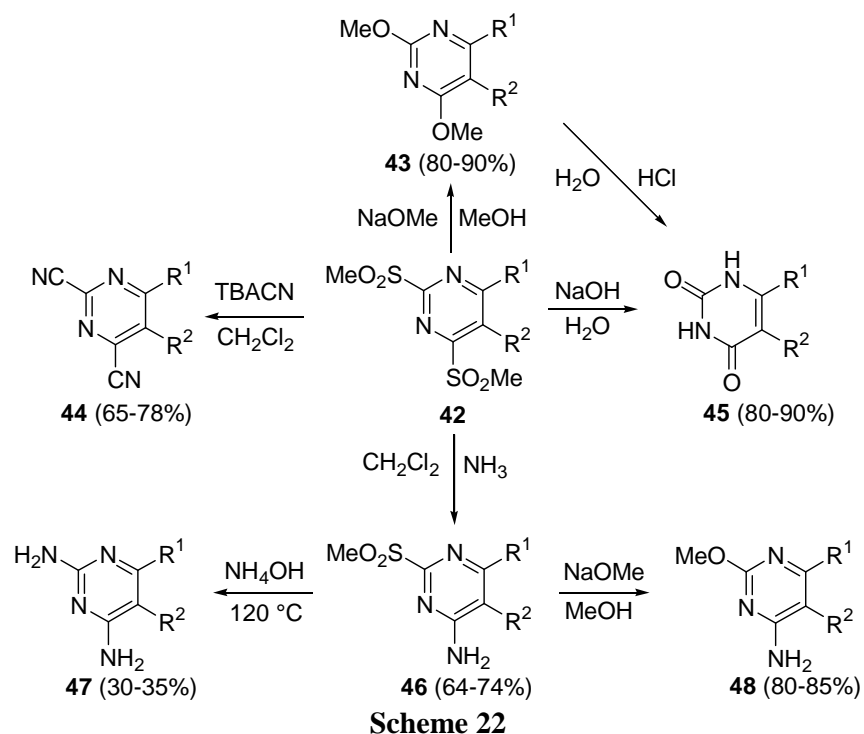

The reaction of methylthiocyanate with aliphatic esters and Tf₂O forms mainly 4-alkoxy-2,6-bis(methylthio)pyrimidines (**49**) together with variable amounts of *S*-methyl alkanoylthiocarbamates (**50**) (Scheme 23).⁴⁹

As described above, methylthio groups can be easily converted to SO₂Me groups. The differing reactivities of the two methylsulfonyl groups toward nucleophiles, gives access to aminoalkoxy, di- and trialkoxypyrimidines (Scheme 24).

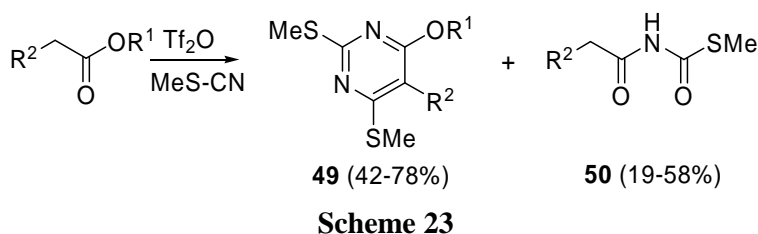

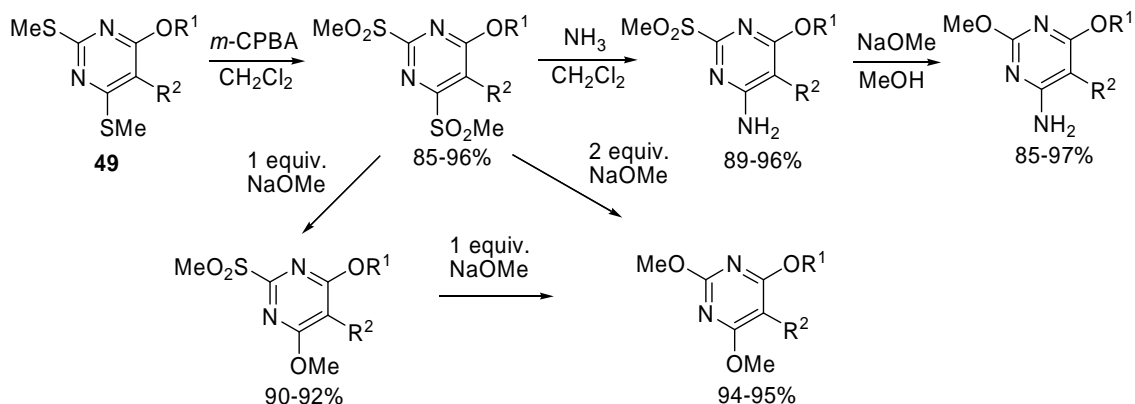

Scheme 24

Surprisingly, the reaction of 2-tetralone with methylthiocyanate leads to a mixture of the expected dihydrobenzoquinazoline (see Section 3.4) and a new compound which was identified as a substituted tetrahydrodibenzo[*a,i*]phenanthridine (**51**) (Scheme 25).⁴⁰ The pentacyclic structure of **51** cannot be explained by the general mechanism for the reaction between ketones and nitriles.²⁴ The structure of **51** indicates that only one nitrile molecule and two molecules of the starting ketone participate in this process. It appears that the first step of the reaction involves the aldol condensation of the 2-tetralone induced by traces of the triflic acid. This process was also observed in the reaction of cyclobutanone with different nitriles (see Section 3.5).⁴⁵ The enone formed by this condensation is attacked by Tf₂O and methylthiocyanate consecutively to form, after TfOH elimination and cyclization, this unexpected phenanthridine **51**.

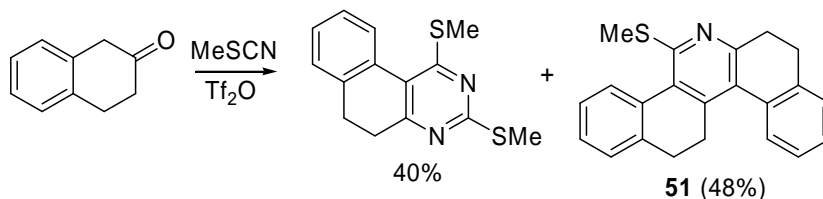

Scheme 25

In Section 3.4 (Scheme 16) the reaction of 1-benzosuberone with different nitriles was shown to afford the corresponding substituted benzocycloheptapyrimidines (**35**).⁴¹ Among these compounds, benzocycloheptapyrimidines bearing nitrogen substituents at positions 2 and 4 are an important class of compounds which exhibit interesting pharmacological applications.⁵⁰ To gain access to these pyrimidine derivatives, we initially tried reactions in which classical nitriles are replaced with cyanamides, but these reacted directly with Tf₂O to give triazines (see Section 5 below). However, the desired 2,4-dialkylamino derivatives were obtained *via* the initial preparation of benzocycloheptapyrimidines (**52**) with easily replaceable substituents at positions 2 and 4. Nucleophilic displacement of these groups with the appropriate nitrogen reagent affords the desired 2,4-dialkylamino substituted pyrimidines (**53–55**) (Scheme 26).⁵¹

We wished to pursue an alternative access to 2,4-dialkylamino substituted pyrimidines by forming the vinyl triflate first and then adding *N,N*-dialkylcyanamides. Thus, when the vinyl triflate **56**, formed from 1-benzosuberone and triflic anhydride, was treated with these cyanamides the corresponding 2,4-dialkylamino substituted pyrimidines were formed in good yields.⁵¹ Thus, two alternative methods permit the synthesis of these important target pyrimidines using either amines or cyanamides (Scheme 27).

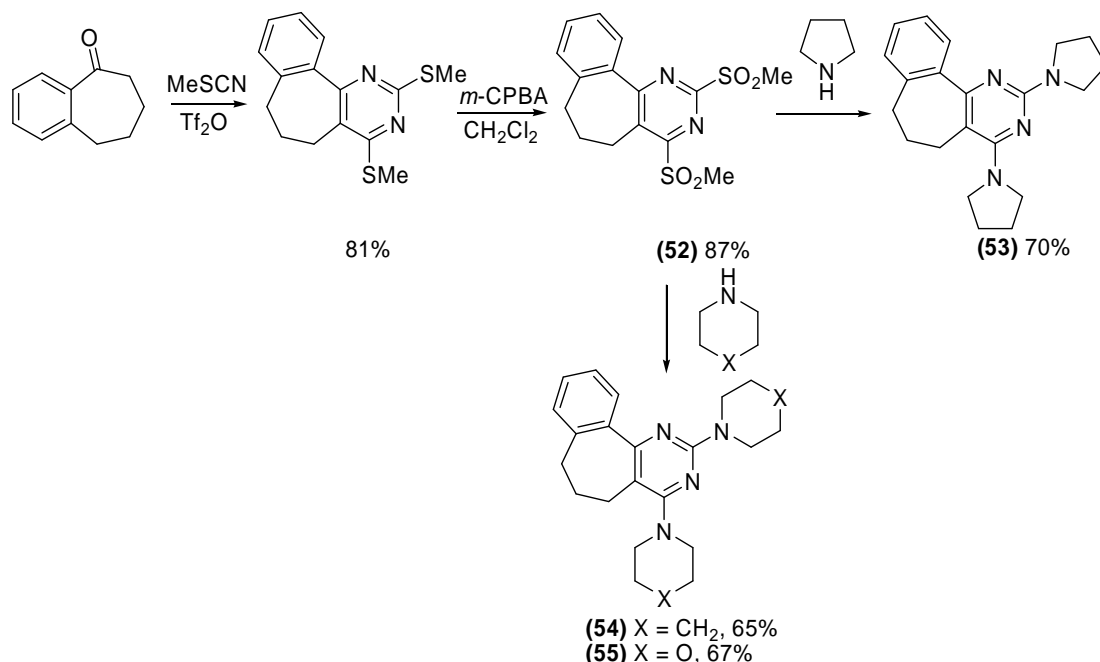

Scheme 26

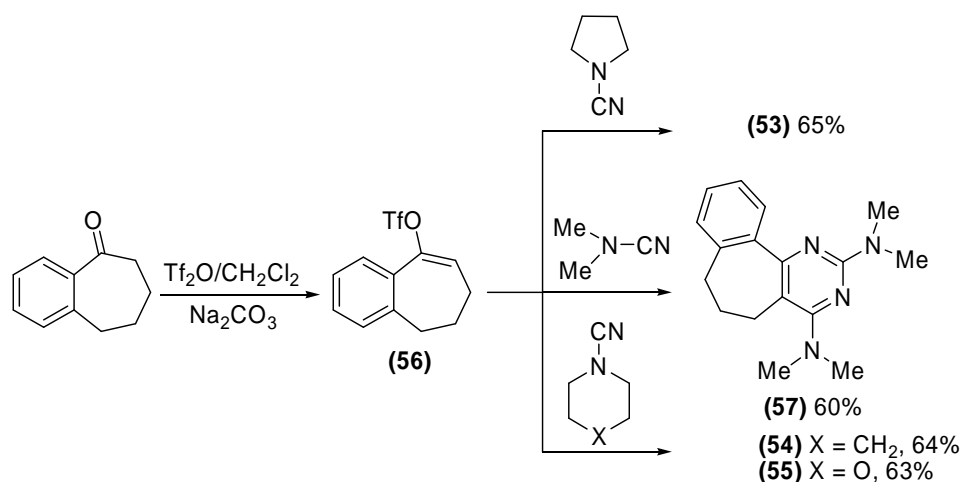

Scheme 27

3.8. Synthesis of heterocycles fused pyrimidines

The reaction of lactones and oxyketones leads to the formation of different pyrano[2,3-*d*]pyrimidines (**58**) and pyrano[4,3-*d*]pyrimidines (**59**) respectively.⁵² When the process is carried out with other lactones such as butyro- or caprolactone, the reaction results in a very complex mixture from which no significant product could be identified. In contrast, the reaction of thiopyranone (**60**) with nitriles and Tf₂O affords only products derived from the aldol condensation of the starting ketone without intervention of the nitrile (Scheme 28).

To avoid side reactions provoked by the electrophilic attack of the triflic anhydride on the nitrogen atom, aminoketones must be protected. Thus, the benzylic protected aminoketone reacts with nitriles to form a substituted pyrido[4,3-*d*]pyrimidine (**61**). During the reaction, the benzyl group is replaced by the trifluoromethanesulfonyl group. If the nitrile is methylthiocyanate, a substituted pyridouracil (**62**) is formed following oxidation and hydrolysis (Scheme 29).⁵³

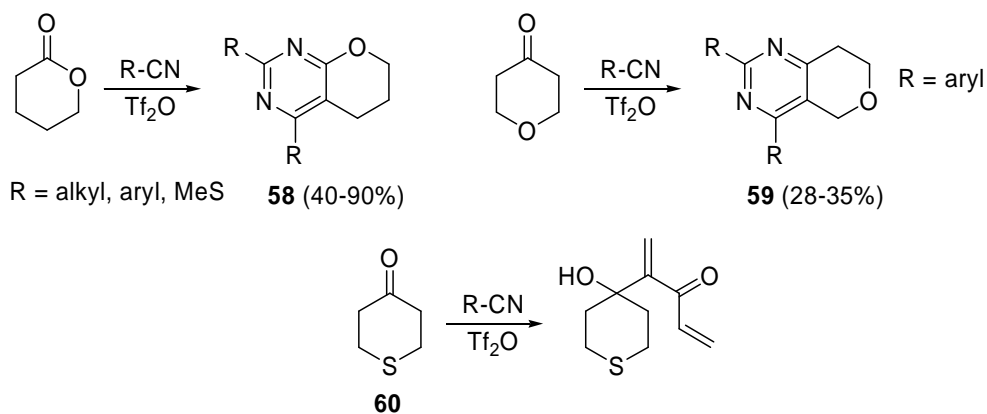

Scheme 28

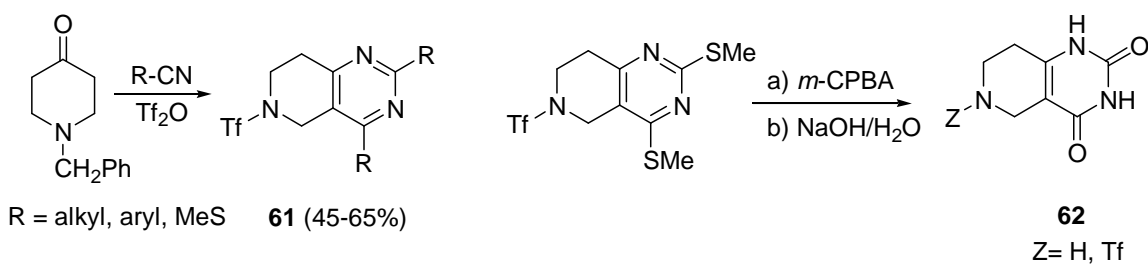

Scheme 29

4. The reaction with carbonyl compounds containing sulfur atoms

4.1. The reaction of thioesters with nitriles and triflic anhydride

4-Alkylthio substituted pyrimidines (**63**) and 4-arylthio substituted pyrimidines (**64**) are easily obtained from the simpler starting materials *S*-methylbutanethioate and *S*-phenylethanethioate, respectively. To extend this synthetic procedure to the preparation of tris(alkylthio)pyrimidines, we investigated the reaction of thioesters with methylthiocyanate. When the latter reacts with *S*-methylbutanethioate, a new product (**65**) was isolated instead of the anticipated tris(methylthio)pyrimidine (Scheme 30). The formation of **65** can be explained by the relative low nucleophilic character of the thiocyanate compared with conventional nitriles. Thus, the triflyloxycarbenium ion formed initially (see Scheme 8) is not attacked by a second molecule of the thiocyanate. Instead, this intermediate rearranges with migration of one of the methylthio groups. After hydrolysis the imidocarbonate **65** is formed.⁵⁴

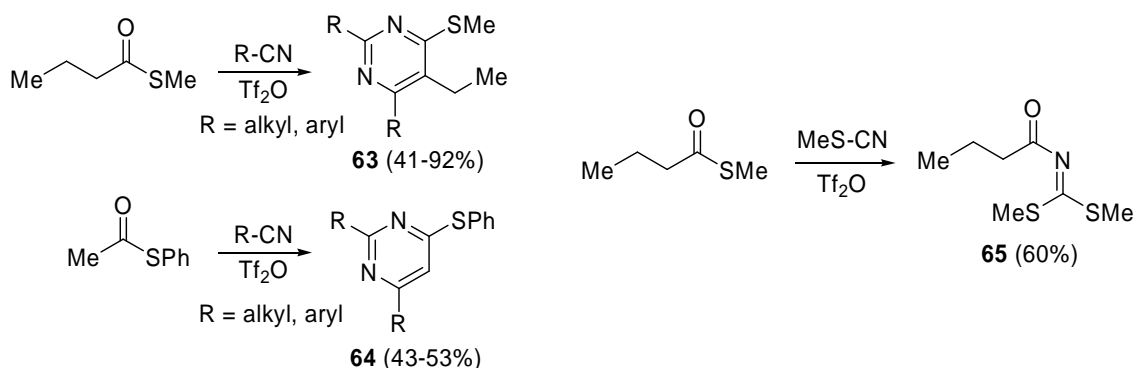

Scheme 30

To verify that the methylthio group migrated from the carbonyl group of the thioester, we repeated the reaction using ethylthiocyanate. Indeed, the product **66** obtained indicated that only one molecule of thiocyanate is involved and that the methylthio group comes from the starting thioester. The stereochemical relationship of the substituents attached at the double bond C=N of **66** was established by NOE experiments (Scheme 31).

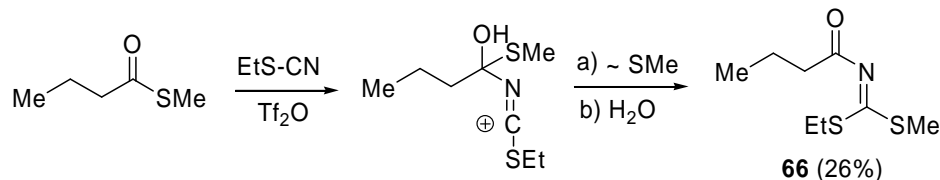

Scheme 31

4.2. Stereoselective synthesis of substituted 1,3-benzothiazines

The reaction of *S*-phenyl ethanethioate and *S*-phenylpropanethioate with substituted benzyl cyanides produces (4*Z*)-2-alkyl-4-benzylidene-4*H*-1,3-benzothiazines (**67**) in moderate yields.⁵⁵ Surprisingly, the formation of the corresponding pyrimidines is not observed (Scheme 32).

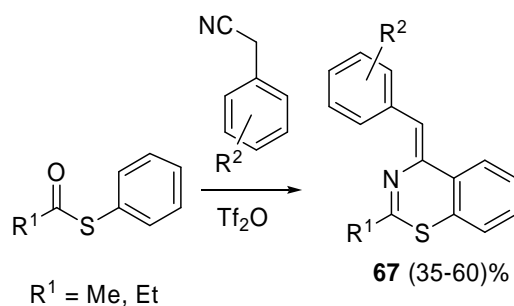

Scheme 32

To explain the formation of the benzothiazine ring we proposed a mechanism (Scheme 33) in which the first steps are the previously discussed formation of triflyloxycarbenium ion and the subsequent nucleophilic attack by a nitrile molecule leading to the nitrilium-immonium ion (**68**). A ring closure through an intramolecular aromatic substitution forms the benzothiazine ring. This step blocks the attack of a second nitrile molecule, thus preventing the pyrimidine formation. This pathway explains the ring formation but the origin of the stereochemistry remains unclarified. The stereochemical requirements for the proton elimination in the last step appear to control the exclusive formation of the *Z* isomer (**70**).

It should be recalled that when the reaction is carried out with an aryl nitrile, only the corresponding pyrimidine is obtained (Scheme 30). The clear difference in products between the reactions of phenyl or methyl as compared to benzyl nitrile raises an intriguing question: what is the role of the methylene moiety bound to the cyano group? To shed light on this, we carried out the reaction with propanenitrile (with a methylene group bound to cyano function) and obtained only the corresponding pyrimidine. It is clear that the methylene group plays an important role but it is necessary that this group is attached to the phenyl ring.

The stereochemistry of the double bond was determined by 2D NOESY experiments. For compound shown in Figure 2, the correlation signals of proton 9 with protons 2' and 5 clearly show the presence of the *Z* isomer.

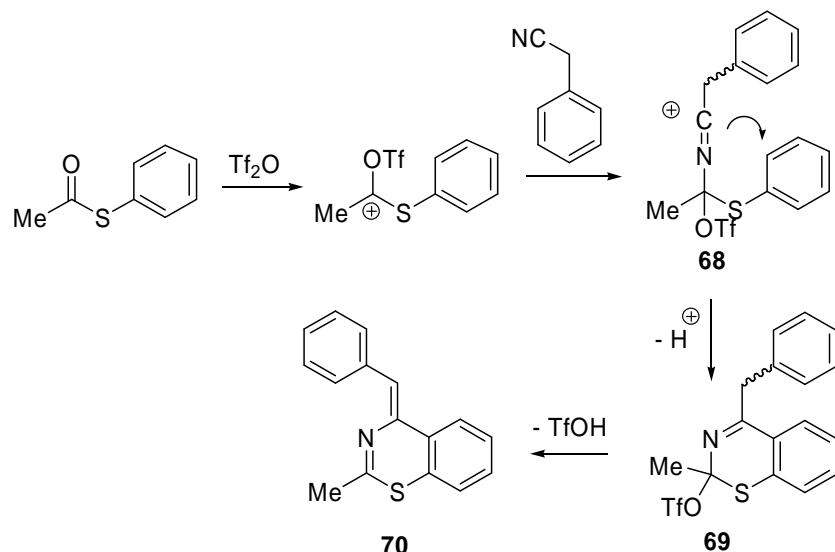

Scheme 33

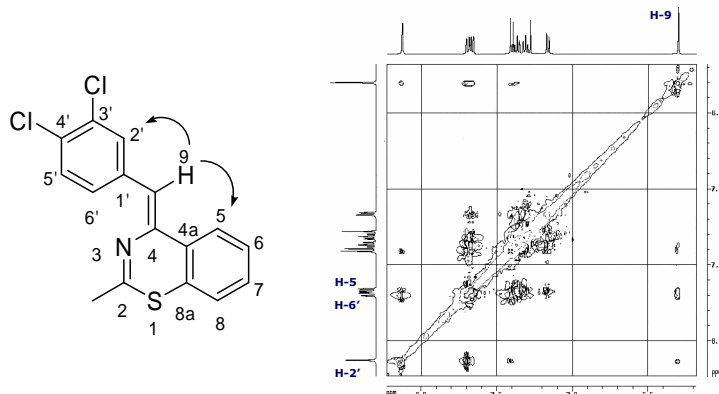
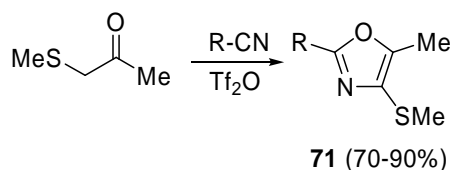

Figure 2

4.3. Synthesis of 1,3-oxazoles

As discussed above in Section 3.3, the reaction of substituted ketones such as halo³⁵ and alkoxyketones⁵⁶ affords the corresponding halo and alkoxy substituted pyrimidines. However, when methylthioacetone reacts with nitriles and triflic anhydride, methylthiopyrimidines were not found and only substituted 1,3-oxazoles (**71**) were isolated (Scheme 34).⁵⁷



Scheme 34

The methylthio group at position C4 can be easily removed by reductive displacement to afford 4-unsubstituted 1,3-oxazoles (**72**). The hydrogen at the C4 position in compounds such as **72** was easily observed in ¹H NMR spectra as quartet (⁴J = 1.1 Hz) coupled to the doublet representing the methyl group at

C5. The methylthio group can also be transformed by oxidation to give 4-methylsulfonyl derivatives (**73**). The use of aromatic dinitriles and control of the reaction stoichiometry permits the preparation of mono (**74**) and bisoxazolyl derivatives (**75**) (Scheme 35).

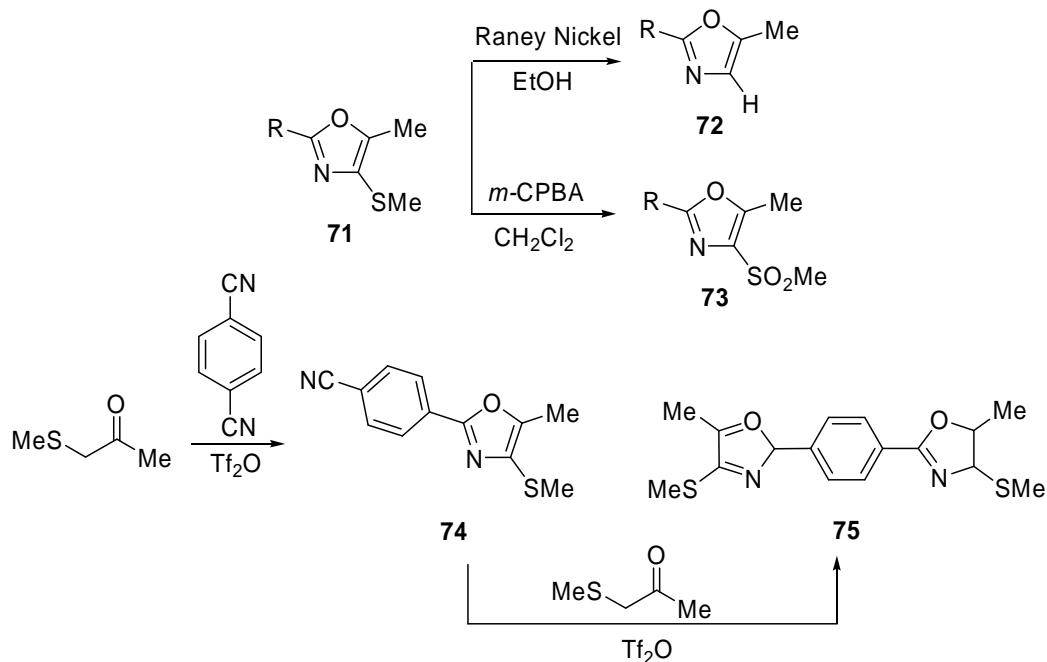

The structure of the oxazole provokes a modification of the proposed general mechanism for this type of reaction (see Scheme 8). Thus, the structure of the final product requires that only one molecule of the nitrile is involved and also that a new C-O bond is formed between the carbon of the cyano group and the carbonyl oxygen. Relating these findings, it leads to the proposal that the nucleophilic attack of the nitrogen atom takes place on the carbon attached to the methylthio group (Scheme 36). Moreover, an equimolar amount of triflic anhydride is necessary because catalytic amounts of this reagent do not produce a significant reaction. We have postulated a new ketotriflate intermediate (**76**).⁵⁷ Unfortunately, several attempts to isolate or trap the intermediate **76** were unsuccessful. Lacking this, we tried to observe the intermediate using NMR spectroscopy at low temperature.

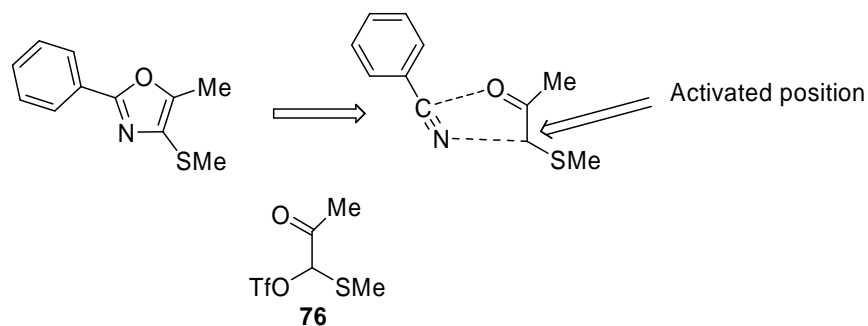

The following figures show the ¹H and ¹³C NMR spectra of the starting methylthioacetone (Figure 3, top). The addition of Tf₂O at low temperature (5 °C) causes new signals to appear (Figure 3, bottom). The

subsequent addition of benzonitrile (Figure 4) provokes a clear evolution of the reaction mixture. After the basic hydrolysis, the spectra of the corresponding oxazole can be observed. It should be noted that when the reaction mixture is allowed to stand at room temperature without addition of the benzonitrile, a total decomposition was observed after two hours.

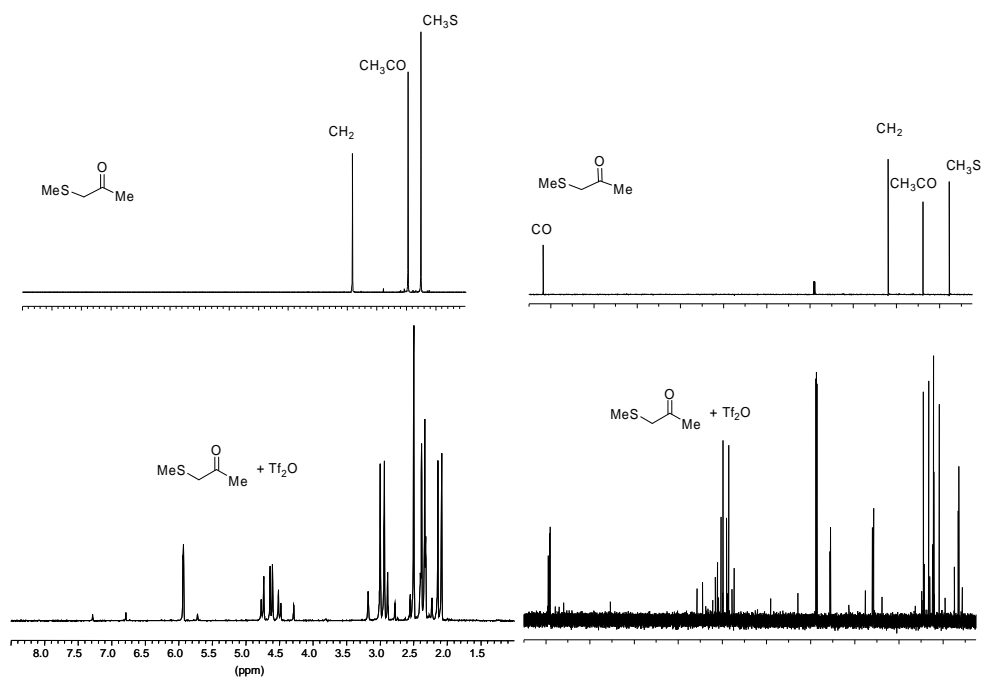

Figure 3

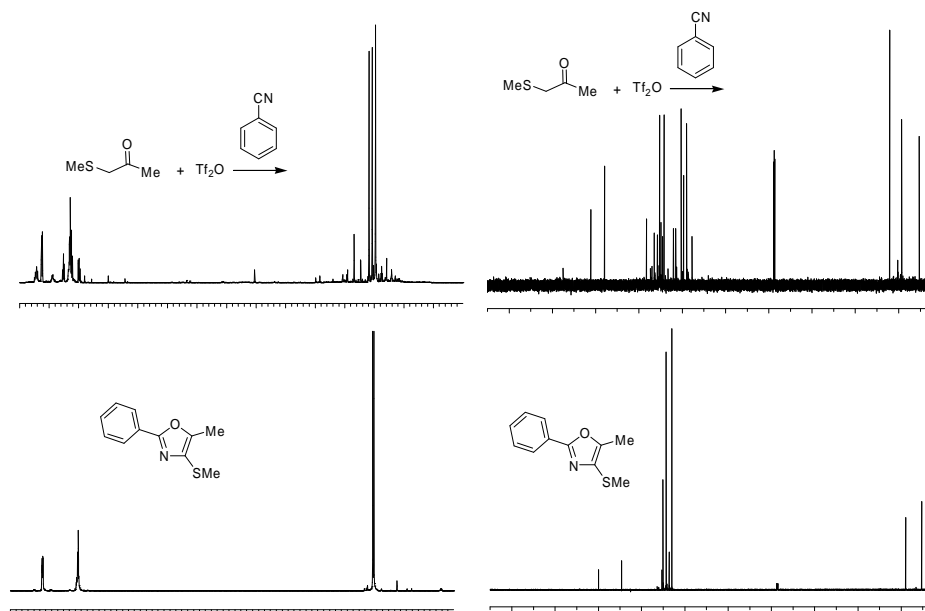
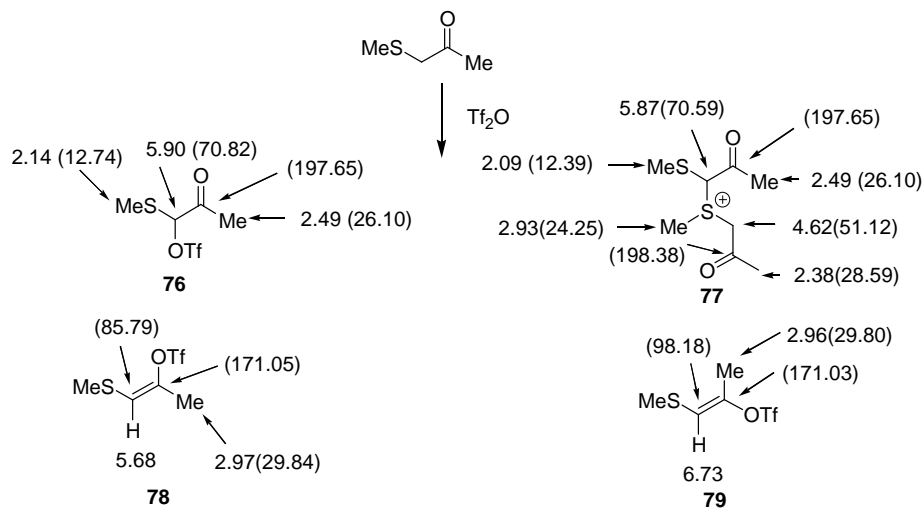

Figure 4

A careful study of the spectra of this reaction with aid of 2D homo and heteronuclear correlations permitted us to identify four intermediates, whose chemical shifts are shown (^{13}C NMR chemical shifts are

parenthesized). These intermediates are: the postulated ketotriflate (**76**), a dimer (**77**) of the starting thioketone and two vinyl triflates (**78**, **79**). These vinyl triflates were found in low concentration (20%) while ketotriflate **76** and the ketonedimer (**77**) were observed in 40% each (Scheme 37).



Scheme 37

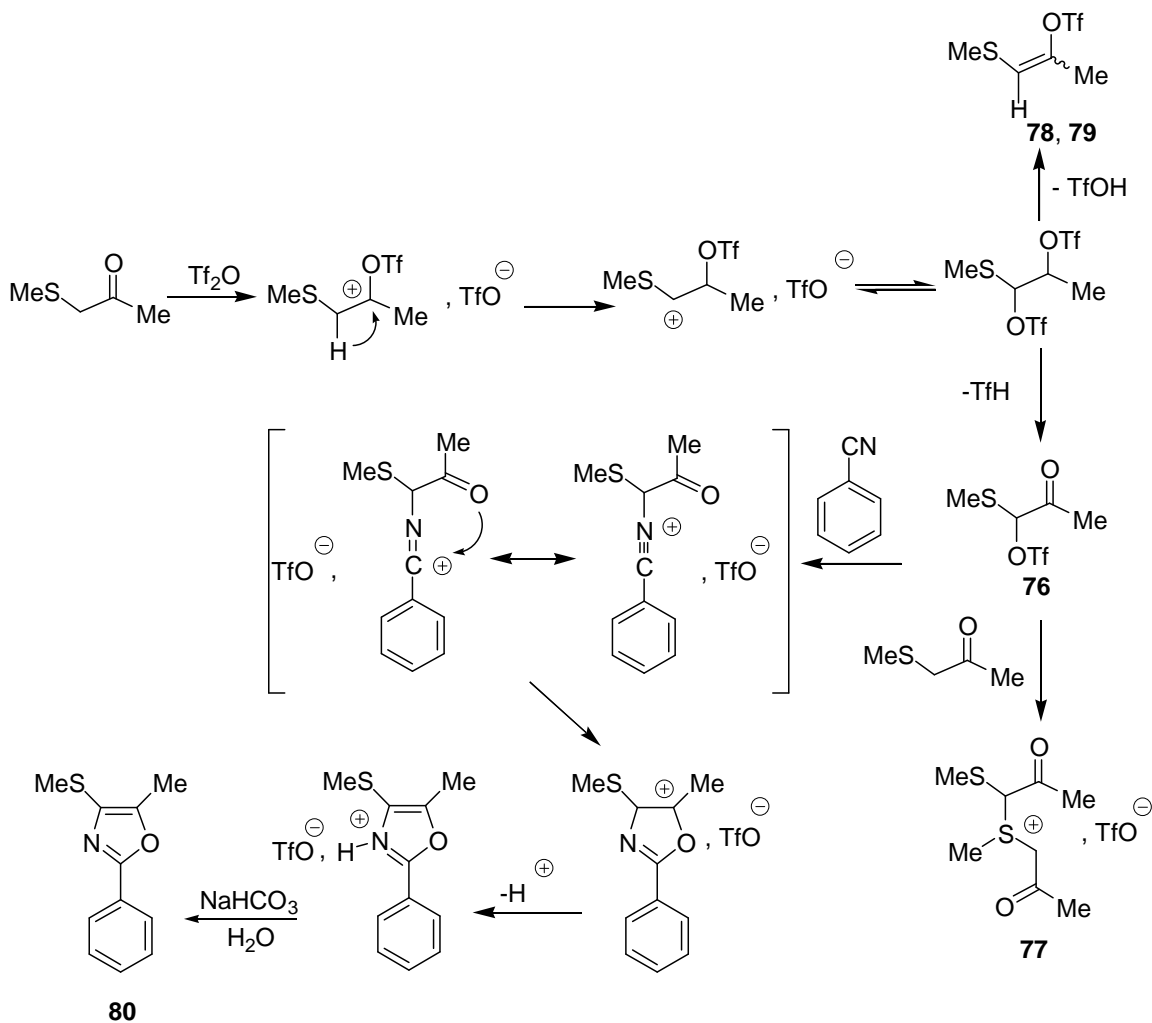

Scheme 38

A mechanism, outlined in Scheme 38, is consistent with these observed intermediates. Thus, the first formed triflyloxycarbenium ion undergoes a hydride rearrangement to form a more stable intermediate. A subsequent trapping by triflate anion followed by an elimination of a trifluoromethanesulfinic acid molecule (TfH) leads to the formation of the postulated ketotriflate **76**. The vinyl triflates (**78**, **79**) and the ketonedimer **77** can also be explained through this mechanism. Finally, the addition of the nitrile causes the displacement of the triflate group followed by a cyclization process. Basic hydrolysis produces the expected oxazole **80** (Scheme 38).

5. Synthesis of 2,4,6-trisubstituted 1,3,5-triazines

Many synthetic procedures for the preparation of 1,3,5-triazines (or *s*-triazines) are known, but almost all require harsh conditions (specially high pressures) or a reagent obtained from a multi-step preparation.⁵⁸ As was mentioned in Section 3.7, the reaction of nitriles or cyanamides with triflic anhydride under mild conditions produces the cyclotrimerization of the nitrile to give very good yields of the corresponding triazines (Scheme 39).⁵⁹

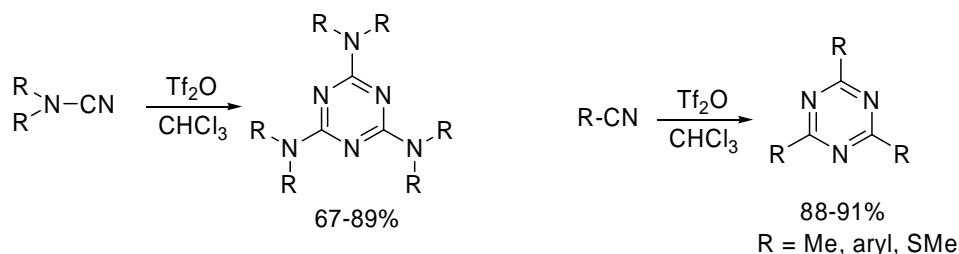

Scheme 39

The reaction takes place with acetonitrile but not with other aliphatic nitriles nor with benzyl nitriles. The mechanism of the reaction is yet to be clarified. It is known that cyanamides react with triflic anhydride to form a bistriflylisourea intermediate which quickly reacts with two molecules of nitrile to give the corresponding triazine.⁶⁰ Further work is in progress in our laboratory to determine the exact pathway of the reaction of nitriles with triflic anhydride and to make it possible for benzyl and alkyl nitriles.⁶¹

Conclusions

The reaction of carbonyl compounds with nitriles and triflic anhydride represents a new synthetic procedure based in a one-pot reaction for the preparation of different classes of heterocycles. Thus, the reaction with ketones allows to prepare alkyl, aryl and cycloalkane fused pyrimidines. Among these, cyclobutapyrimidines are excellent precursors for the *in situ* generation of pyrimidine *ortho*-quinodimethanes (*o*-QDM) which can be trapped with different dienophiles. Halo- and alkoxy pyrimidines can be also prepared either from haloketones or from aliphatic esters. The general mechanism of the reaction is well established. Several examples indicate an unexpected behaviour of the benzyl nitriles when these compounds bear electron-donating substituents. The use of methylthiocyanate results in the synthesis of pyrimidines bearing methylthio groups that can be easily removed by different nucleophiles after oxidation to the corresponding methylsulfonyl groups. Carbonyl compounds containing sulfur atoms such as thioesters and thioketones react following a different pathway affording benzothiazines and oxazoles, respectively. Finally, the reaction of nitriles with triflic anhydride leads to the formation of *s*-triazines.

Acknowledgments

The authors would like to thank all the co-workers who made this work possible with their valuable contributions. We also acknowledge the Spanish Ministerio de Educación y Ciencia that provided funding with grants that supported this research over several years.

References

1. (a) Engelbrecht, A. *Angew. Chem.* **1965**, *77*, 695; *Angew. Chem. Int. Ed.* **1965**, *4*, 641. (b) Gillespie, R. *J. Acc. Chem. Res.* **1968**, *1*, 202.
2. Howells, R. D.; McCown, J. C. *Chem. Rev.* **1977**, *77*, 69.
3. Gramstad, T.; Haszeldine, R. N. *J. Chem. Soc.* **1957**, 2640.
4. Cox, A. R.; Krull, U. J.; Thompson, N.; Yates, K. *Anal. Chim. Acta* **1979**, *106*, 51.
5. Stang, P. J. In *Alkynyliodonium Salts: Electrophilic Acetylene Equivalents. Modern Acetylene Chemistry*; Stang, P. J.; Diederich, F., Eds.; VCH: Weinheim, 1995; p. 67.
6. (a) Hansen, R. L. *J. Org. Chem.* **1965**, *29*, 4322. (b) Streitwieser, A., Jr.; Wilkins, C. L.; Kiehlmann, E. *J. Am. Chem. Soc.* **1968**, *90*, 1598. (c) Su, T. M.; Sliwinski, W. F.; Schleyer, P. V. R. *J. Am. Chem. Soc.* **1969**, *91*, 5386.
7. Stang, P. J.; Anderson, A. G. *J. Org. Chem.* **1976**, *41*, 781.
8. (a) Simonato, J. P.; Lambert, J. F. *Actualité Chimique* **2005**, *292*, 55. (b) Rakita, P. E. *Chimica Oggi* **2004**, *22*, 48.
9. (a) Kobayashi, S.; Masaharu, S.; Kitagawa, H.; Lam, W. L. *Chem. Rev.* **2002**, *102*, 2227. (b) Luo, S.; Lizhi, Z.; Talukdar, A.; Guisheng, Z.; Mi, X.; Cheng, J. P.; Wang, P. G. *Mini-Rev. Org. Chem.* **2005**, *2*, 177.
10. (a) Stang, P. J.; Hanack, M.; Subramanian, L. R. *Synthesis* **1982**, 85. (b) Ritter, K. *Synthesis* **1993**, 735.
11. Baraznenok, I. L.; Nenajdenko, V. G.; Balenkova, E. S. *Tetrahedron* **2000**, *56*, 3077.
12. Stang, P. J.; Summerville, R. H. *J. Am. Chem. Soc.* **1969**, *91*, 4600.
13. (a) Stang, P. J.; Rappoport, Z.; Hanack, M.; Subramanian, L. R. In *Vinyl Cations*; Academic Press: New York, 1979. (b) Hanack, M.; Subramanian, L. R. In *Houben-Weyl, Methods of Organic Chemistry, Low-valent Carbon Compounds: Carbocations*; Georg Thieme: Stuttgart, 1990; Vol. E19c.
14. Scott, W. J.; McMurry, J. E. *Acc. Chem. Res.* **1988**, *21*, 47.
15. (a) Echavarren, A.; Stille, J. K. *J. Am. Chem. Soc.* **1987**, *109*, 5478. (b) Cacchi, S. *Pure Appl. Chem.* **1996**, *68*, 45. (c) Wada, A.; Babu, G.; Shimomoto, S.; Ito, M. *Synlett* **2001**, 1759. (d) Arcadi, A.; Chiarini, M.; Marinelli, F.; Berente, Z.; Kollar, L. *Eur. J. Org. Chem.* **2001**, 3165. (e) Occhiato, E. G. *Mini-Rev. Org. Chem.* **2004**, *1*, 149. (f) Ogasawara, M.; Ge, Y.; Uetake, K.; Yakahashi, T. *Org. Lett.* **2005**, *7*, 5697. (g) Tong, R.; Valentine, J. C.; McDonald, F. E.; Cao, R.; Fang, X.; Hardcastle, K. I. *J. Am. Chem. Soc.* **2007**, *129*, 1050. (h) Bower, J. F.; Williams, A. J.; Woodward, H. L.; Szeto, P.; Lawrence, R. M.; Gallagher, T. *Org. Biomol. Chem.* **2007**, *5*, 2636.
16. (a) García Martínez, A.; Herrera Fernández, A.; Martínez-Alvarez, R.; Subramanian, L. R. *Synthesis* **1984**, 481. (b) García Martínez, A.; Martínez-Alvarez, R.; García Fraile, A.; Hanack, M.; Subramanian, L. R. *Synthesis* **1986**, 222. (c) García Martínez, A.; Martínez-Alvarez, R.; Madueño Casado, M.; Hanack, M.; Subramanian, L. R. *Tetrahedron* **1987**, *43*, 275. (d) García Martínez, A.; Martínez-Alvarez, R.; García Fraile, A.; Hanack, M.; Subramanian, L. R. *Chem. Ber.* **1987**, *120*, 1255.
17. (a) Ogawa, T.; Kiji, T.; Hayami, K.; Suzuki, H. *Chem. Lett.* **1991**, 1443. (b) Wallace, D.; Klauber, D. J.; Chen, C.; Volante, R. P. *Org. Lett.* **2003**, *5*, 4749. (c) Zhao, H.; Vanderbossche, C. P.; Koenig, S. G.; Singh, S. P.; Bakale, R. P. *Org. Lett.* **2008**, *10*, 505. (d) Matsubara, R.; Kobayashi, S. *Acc. Chem. Res.* **2008**, *41*, 292.
18. (a) García Martínez, A.; Herrera Fernández, A.; Martínez-Alvarez, R.; Teso Vilar, E.; García Fraile, A.; Osío Barcina, J.; Pargada Iglesias, L. *Tetrahedron Lett.* **1987**, 1929. (b) García Martínez, A.; Herrera Fernández, A.; Martínez-Alvarez, R.; Teso Vilar, E.; García Fraile, A.; Osío Barcina, J.; Pargada Iglesias, L.; Unanue, R.; Hanack, M.; Subramanian, L. R. *J. Heterocycl. Chem.* **1988**, *25*, 1237.
19. García Martínez, A.; Herrera Fernández, A.; Martínez-Alvarez, R.; Silva Losada, M.; Molero Vilchez, D.; Subramanian, L. R.; Hanack, M. *Synthesis* **1990**, 881.

20. (a) Brown, D. J.; Evans, R. F.; Cowden, W. B.; Fenn, M. D. *The Pyrimidines In The Chemistry of Heterocyclic Compounds*; John Wiley & Sons: New York, 1985; Vol. 16, Suppl. 2. (b) Brown, D. J. In *The Pyrimidines*; Wiley; New York, 1994. (c) Undheim, K.; Benneche, T. In *Comprehensive Heterocyclic Chemistry II*; Katritzky, A. R.; Rees, C. W.; Scriven, E. F. V.; McKillop, A., Eds.; Pergamon: Oxford, 1996; Vol. 6. (d) Joule, J. A.; Mills, K. In *Heterocyclic Chemistry*, 4th ed.; Blackwell Science Ltd.: Cambridge (MA, USA); 2000.
21. (a) Erian, A. W. *Chem. Rev.* **1993**, *93*, 1991. (b) Michael, J. P. *Nat. Pro. Rep.* **2005**, *22*, 627. (c) Kakiya, H.; Yagi, K.; Shinokubo, H.; Oshima, K. *J. Am. Chem. Soc.* **2002**, *124*, 9032.
22. (a) Charette, A. B.; Grenon, M. *Can. J. Chem.* **2001**, *79*, 1694. (b) Charette, A. B.; Mathieu, S.; Martel J. *Org. Lett.* **2005**, *7*, 5401.
23. (a) Movassaghi, M.; Hill, M. D. *J. Am. Chem. Soc.* **2006**, *128*, 14254. (b) Movassaghi, M.; Hill, M. D. *Nat. Protoc.* **2007**, *2*, 2018.
24. (a) García Martínez, A.; Teso Vilar, E.; Gómez Marín, M.; Ruano Franco, C. *Chem. Ber.* **1985**, *118*, 1282. (b) García Martínez, A.; Martínez-Alvarez, R.; García Fraile, A.; Subramanian, L. R.; Hanack, M. *Synthesis* **1987**, 49. (c) Wright, E.; Pulley, S. R. *J. Org. Chem.* **1987**, *54*, 2886.
25. García Martínez, A.; Herrera Fernández, A.; Moreno Jiménez, F.; García Fraile, A.; Subramanian, L. R.; Hanack, M. *J. Org. Chem.* **1992**, *57*, 1627.
26. Moreno Jiménez, F. PhD Dissertation, Universidad Complutense de Madrid, 1994.
27. Herrera Fernández, A.; Martínez-Alvarez, R. unpublished results.
28. Herrera Fernández, A.; Martínez-Alvarez, R.; Chioiua, R.; Chioua, M.; Almy, J.; Loaiza, O. J. *Arkivoc* **2007**, *xvi*, 58.
29. (a) Brown, H. C.; Kanner, B. *J. Am. Chem. Soc.* **1953**, *75*, 3865. (b) Crich, D.; Smith, M.; Yao, Q.; Picione, J. *Synthesis* **2001**, 323.
30. Kakushima, M.; Hamel, P.; Frenette, R.; Rokach, J. *J. Org. Chem.* **1983**, *48*, 3214.
31. García Martínez, A.; Herrera Fernández, A.; Moreno Jiménez, F.; Muñoz Martínez, P.; Alonso Martín, C.; Subramanian, L. R. *Tetrahedron* **1996**, *52*, 7973.
32. Martínez-Alvarez, R.; Herrera Fernández, A.; Chioua, R.; Chioua, M.; Villalba Vilchez, N.; Guzmán Torres, F. *Rapid. Commun. Mass Spectrom.* **1999**, *13*, 2480.
33. Martínez-Alvarez, R.; Herrera Fernández, A.; Sánchez Vazquez, A.; Aladro Maroto, J.; Chioua, R.; Chioua, M. *Rapid Commun. Mass Spectrom.* **1999**, *13*, 79.
34. Herrera, A.; Martínez-Alvarez, R.; Chioua, M.; Chioua, R.; Sánchez, A. *Tetrahedron* **2002**, *58*, 10053.
35. García Martínez, A.; Herrera Fernández, A.; Molero Vilchez, D.; Hanack, M.; Subramanian, L. R. *Synthesis* **1992**, 1053.
36. García Martínez, A.; Herrera Fernández, A.; Martínez-Alvarez, R.; Molero Vilchez, D.; Laorden Gutierrez, M.; Subramanian, L. R. *Tetrahedron* **1999**, *55*, 4825.
37. García Martínez, A.; Herrera Fernández, A.; Molero Vilchez, D.; Laorden Gutierrez, M.; Subramanian, L. R. *Synlett* **1993**, 229.
38. Ferrini, S.; Ponticelli, F.; Taddei, M. *Org. Lett.* **2007**, *9*, 69.
39. Marzaro, G.; Chilin, A.; Pastorini, G.; Guiotto, A. *Org. Lett.* **2006**, *8*, 255.
40. Herrera, A.; Martínez-Alvarez, R.; Chioua, M.; Chioua, R.; Chatt, R.; Sánchez, A.; Almy, J. *Tetrahedron* **2006**, *62*, 2799.
41. Herrera, A.; Martínez-Alvarez, R.; Chioua, R.; Chioua, M. *Tetrahedron. Lett.* **2003**, *44*, 2149.
42. (a) Afonso, A.; Nelly, J. M.; Weinstein, J.; Wolin, R. L.; Rosenblum, S. B. *US Patent* 6 218 401, **2001**; *Chem. Abstr.* **2001**, *134*, 295746. (b) Benoit, J.; Alagille, D.; Merour, J. Y.; Leonce, S. *Chem. Pharm. Bull.* **2000**, *48*, 1872.
43. Herrera, A.; Martínez-Alvarez, R.; González, B.; Illescas, B.; Martín, N.; Seoane, C. *Tetrahedron Lett.* **1997**, *38*, 4873.
44. Herrera, A.; Martínez-Alvarez, R.; Chioua, M.; Chioua, R.; Almy, J. *Lett. Org. Chem.* **2006**, *3*, 703.
45. González B.; Herrera, A.; Illescas, B.; Martín, N.; Martínez-Alvarez, R.; Moreno, F.; Sánchez, L.; Sánchez, A. *J. Org. Chem.* **1998**, *63*, 6807.
46. Herrera, A.; Martínez-Alvarez, R.; Ramiro, P.; Chioua, M.; Torres, R. *Tetrahedron* **2002**, *58*, 3755.
47. Herrera, A.; Martínez-Alvarez, R.; Ramiro, P.; Torres, R. *Z. Kristallogr. NCS.* **2004**, *219*, 305.

48. García Martínez, A.; Herrera Fernández, A.; Moreno Jiménez, F.; Luengo Fraile, M.; Subramanian, L. R. *Synlett* **1994**, 559.
49. Herrera Fernández, A.; Martínez-Alvarez, R.; Ramiro, P.; Almy, J.; Molero, D.; Sánchez, A. *Eur. J. Org. Chem.* **2006**, 3332.
50. (a) Robl, J. A.; Bang-Chi, C.; Chong-Qing, S. *US Patent* 20002061901; *Chem. Abstr.* **2001**, 136, 401651. (b) Ganguly, A. K.; Doll, A. K.; Girijavallabhan, V. M. *Curr. Med. Chem.* **2001**, 8, 1419.
51. Herrera, A.; Martínez-Alvarez, R.; Chioua, R.; Benabdelouahab, F.; Chioua, M. *Tetrahedron* **2004**, 60, 5475.
52. Herrera, A.; Martínez-Alvarez, R.; Ramiro, P.; Almy, J. *Monatsh. Chem.* **2006**, 137, 1421.
53. Herrera, A.; Martínez-Alvarez, R.; Chioua, R.; Almy, J. *Tetrahedron Lett.* **2006**, 47, 5463.
54. Herrera Fernández, A.; Martínez-Alvarez, R.; Ramiro, P. *Tetrahedron* **2003**, 59, 7331.
55. Herrera, A.; Martínez-Alvarez, R.; Ramiro, P.; Sánchez, A.; Torres, R. *J. Org. Chem.* **2004**, 69, 4545.
56. Molero Vilchez, D. PhD Dissertation, Universidad Complutense de Madrid, 1993.
57. Herrera, A.; Martínez-Alvarez, R.; Ramiro, P.; Molero, D.; Almy, J. *J. Org. Chem.* **2006**, 71, 3026.
58. (a) Hurst, D. T. In *Progress in Heterocyclic Chemistry*; Suschitzky, H.; Scriven, E. F. V., Eds.; Pergamon: Oxford, 1995; Vol. 7, p. 244. (b) von Angerer, S.; Abbach, B. *Science of Synthesis* **2004**, 17, 449.
59. Herrera, A.; Martínez-Alvarez, R.; Ramiro, P.; Chioua, M.; Chioua, R. *Synthesis* **2004**, 503.
60. García Martínez, A.; Herrera Fernández, A.; Moreno Jiménez, F.; Martínez Ruiz, P.; Subramanian, L. R. *Synlett* **1995**, 161.
61. Herrera Fernández, A.; Martínez-Alvarez, R. unpublished results.

METAL-MEDIATED C–C AND C–N BOND FORMATION IN THE SYNTHESIS OF BIOACTIVE PURINES

Lise-Lotte Gundersen

Department of Chemistry, University of Oslo, P. O. Box 1033, Blindern N-0315 Oslo, Norway
(e-mail: l.l.gundersen@kjemi.uio.no)

Abstract. Development of metal-mediated C–C and C–N bond forming reactions has facilitated synthesis of a wide variety of purine and purine nucleoside derivatives. Aryl- and alkenyl-substituents can be readily introduced in the purine 2-, 6- or 8-position by Pd-catalyzed Stille, Negishi, or Suzuki-Miyaura coupling on halopurines. The Negishi reaction is normally the method of choice for synthesis of 2-, 6- or 8-alkylpurines, and alkynylpurines are readily available by Sonogashira coupling. C–C Bond formation has to some extent also been carried out via metallated purines, but such strategies seldom compete favourable with couplings between halopurines and organometallic reagents. Arylaminopurines can be synthesized by Buchwald-Hartwig reactions on halopurines or aminopurines. Arylation of purine N-9 and N-1 has been achieved by Cu-mediated reactions with arylboronic acids and a wide range of carbocyclic purine nucleosides has been prepared with Pd(0)-catalyzed allylic alkylation as a key-step. Numerous purines displaying interesting bioactivities, as for instance cytotoxic, antimicrobial and antiviral activities have been synthesized according to the methodologies discussed herein. The same is true also for adenosine receptor ligands, cytokinins and 15-lipoxygenase inhibitors.*

Contents

1. Introduction
2. C–C Bond formation
 - 2.1. Addition of organometallic reagents followed by rearomatization
 - 2.1.1. Addition of organolithium reagents
 - 2.1.2. Addition of organomagnesium reagents
 - 2.2. Cross-coupling of halopurines
 - 2.2.1. Coupling with organolithium reagents
 - 2.2.2. Coupling with organocuprates-copper-mediated couplings
 - 2.2.3. Coupling with organomagnesium reagents
 - 2.2.4. Coupling with organotin reagents (Stille coupling)
 - 2.2.5. Coupling with organozinc reagents (Negishi coupling)
 - 2.2.6. Coupling with organoboron reagents (Suzuki-Miyaura coupling)
 - 2.2.7. Coupling with organoaluminium reagents
 - 2.2.8. Heck coupling
 - 2.2.9. Sonogashira coupling
 - 2.2.10. Direct CH alkylation and arylation

* Only articles published (printed or web preview) before April 15th 2008 have been taken into account.

- 2.2.11. Regioselectivity in cross coupling reactions of dihalopurines
- 2.2.12. Further transformation of coupling products
- 2.3. C–C Bond formation *via* metallated purines
 - 2.3.1. Generation and reactivity of lithiated purines
 - 2.3.2. Generation and reactivity of stannylated purines
 - 2.3.3. Generation and reactivity of zincated purines
 - 2.3.4. Generation and reactivity of magnesiated purines
 - 2.3.5. Generation and reactivity of palladated purines
- 3. C–N Bond formation
 - 3.1. Buchwald-Hartwig coupling
 - 3.1.1. Buchwald-Hartwig reaction on halopurines
 - 3.1.2. Buchwald-Hartwig reaction on aminopurines
 - 3.2. Cu-mediated *N*-arylation
 - 3.3. Palladium(0)-mediated *N*-allylation
- 4. Biological activities
 - 4.1. Cytotoxic purines
 - 4.2. Antimicrobial purines
 - 4.3. Antiviral purines
 - 4.4. Adenosine receptor ligands
 - 4.5. Cytokinin analogs
 - 4.6. Inhibitors of 15-lipoxygenase
- 5. Conclusions

Acknowledgments

References

Abbreviations

1. Introduction

Purine (**1**) is the most abundant nitrogen-containing heterocycle on earth (Scheme 1).¹ Purine (**1**) itself, first synthesized by Emil Fischer in 1899,² is not found in nature, but the bicyclic ring system is present in many of naturally occurring compounds with a wide variety of biological roles.

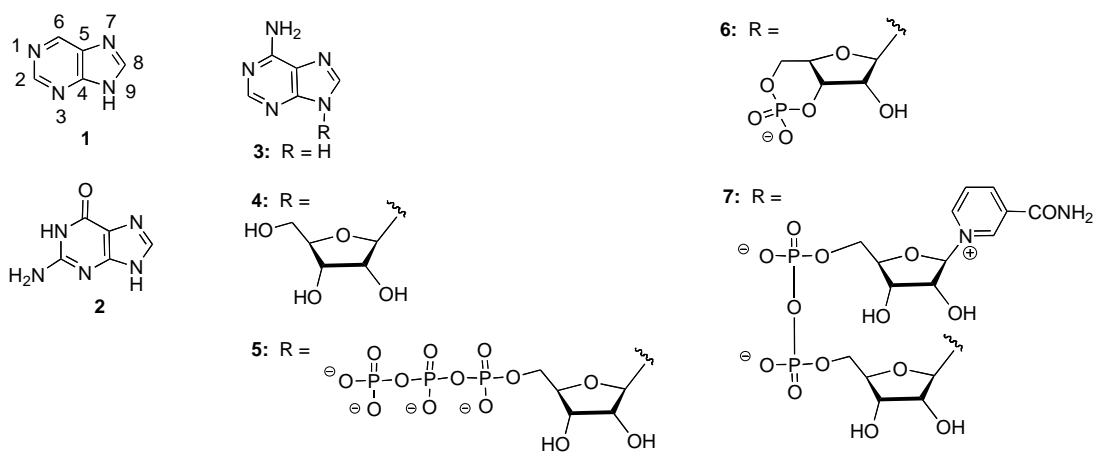

Scheme 1

Guanine (**2**) and adenine (**3**) are DNA and RNA bases and the adenine moiety is found in adenosine (**4**, signalling substance), adenosine 5'-triphosphate (ATP, **5**, energy storage) cyclic AMP (cAMP, **6**, second messenger) and nicotinamide adenine dinucleotide (NADH/NAD⁺, **7**, co-enzyme), all examples of important compounds in humans.

Plants, microorganisms as well as marine sponges, tunicates and related organisms are also producing tremendous amounts of bioactive purines. Plant growth hormones of the cytokinin class, *i.e.* 6-benzylaminopurine (**8**) and *trans*-zeatin (**9**) are purine derivatives³ (Scheme 2). Caffeine (**10**), heteromines **11** (cytotoxic compounds from *Heterostemma brownii*)⁴ and crotonoside (**12**, an antibiotic compound isolated from *Croton tiglium*⁵ and other sources⁶) are other examples of bioactive purines found in higher plants.

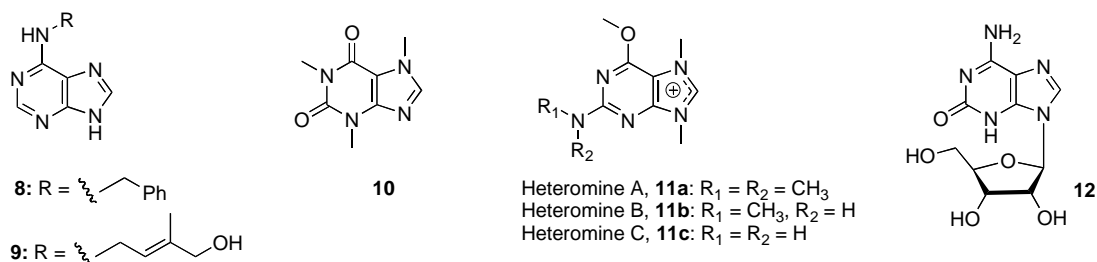

Scheme 2

Cytotoxic and antimicrobial agelasines,⁷ *e.g.* agelasine A (**13**), isolated from marine sponges (*Agelas* sp.), aplidiamine (**14**) from the marine ascidian *Aplidiopsis* sp.,⁸ cytotoxic asmarines,⁹ *i.e.* asmarine A (**15**), from the marine sponge *Raspailia* sp. and the extremely toxic paralytic shell fish poison saxitoxin (**16**) produced by certain dinoflagellates,¹⁰ illustrate some of the structural diversity found for purines isolated from microorganisms and marine sponges (Scheme 3). The same is true for the nucleoside-like compounds amipurimycin (**17**, antifungal compound from *Streptomyces* sp.),¹¹ herbicidin B (**18**, antimicrobial compound from *Streptomyces* sp.),¹² oxetanocine A (**19**, antiviral compound from *Bacillus* sp.),¹³ trachycladine A (**20**, cytotoxic compound found in several marine sponges)¹⁴ and neplanocin A (**21**, antileucemic and antiviral compound from *Streptomyces* sp.).¹⁵

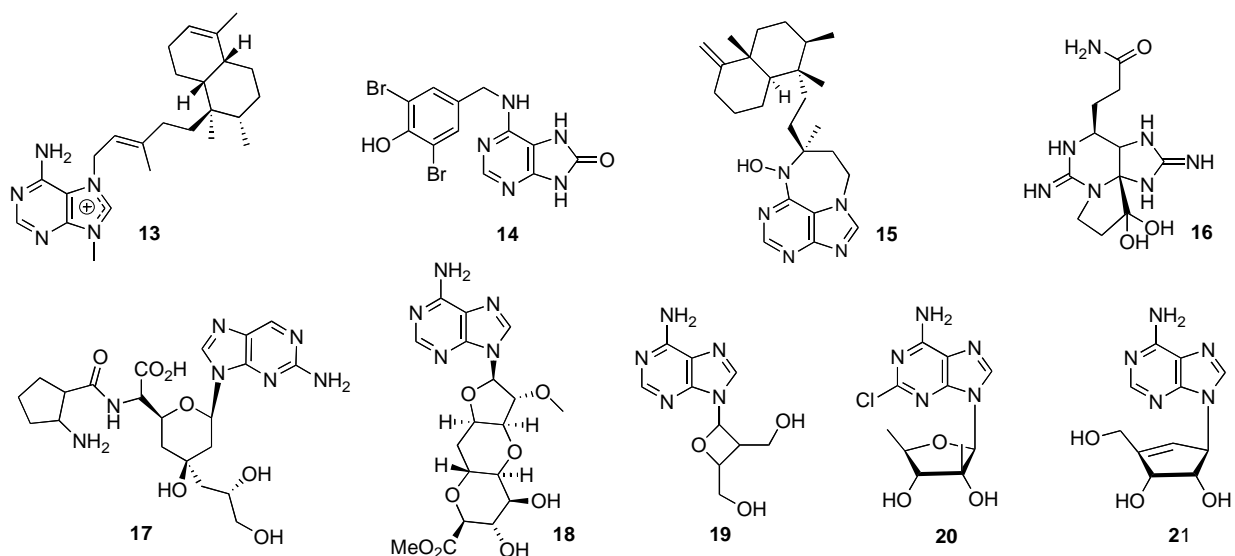

Scheme 3

Since purines are involved in so many essential biological processes, derivatives have been extensively studied as potential drugs and molecular tool and several purines are clinically used as drugs, especially as anticancer- and antiviral compounds. The purine antimetabolites 6-mercaptapurine (**22**)¹⁶ and fludarabine phosphate (**23**),¹⁷ used in cancer therapy, the immunosuppressive drug azathioprine (**24**)^{16d,18} and the antivirals acyclovir (**25**, herpes)¹⁹ and didanosine (ddI, **26**, HIV)²⁰ are some examples of clinically used purine-derived drugs (Scheme 4).

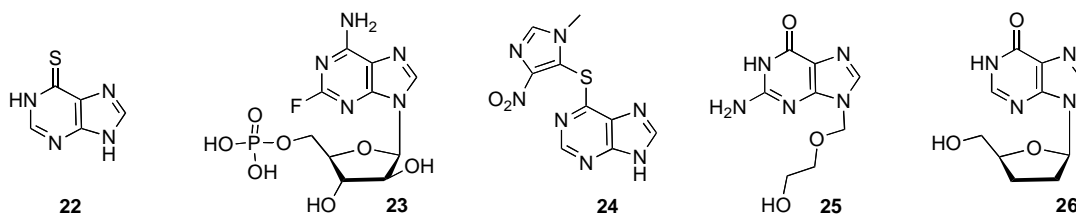

Scheme 4

No wonder, synthesis of modified purines as potential drugs or molecular tools is an active research area. Development of metal-mediated reactions for C–C and C–N bond formation has facilitated the synthesis of a number of novel purines, many of them with highly interesting biological activities. In the chapters, applications of organometallic reactions for C–C and C–N bond formation in purine chemistry are discussed.

2. C–C Bond formation

Before the development of modern organometallic chemistry, especially cross-coupling reactions, methods for the formation of C–C bonds in purines were limited. 6-Chloropurines have been transformed to alkyl or alkenylpurines *via* reaction with an alkyldienfosforane,²¹ and 6-thiopurines may undergo an Eschenmoser rearrangement.²² Furthermore, C–C bond formation under radical conditions²³ are known, but in most instances purines containing carbon substituents in the 2-, 6- or 8-position were prepared by ring closing reactions of appropriately substituted pyrimidines or imidazoles. Today, such compounds may, to some extent, be prepared by addition of an organometallic reagent to the electron deficient purine ring system followed by rearomatization. More important are cross-coupling reactions on halopurines or in some cases, on metallated purines. These strategies are discussed in details below. This chemistry has partly been reviewed before.²⁴

2.1. Addition of organometallic reagents followed by rearomatization

2.1.1. Addition of organolithium reagents

Phenyllithium adds to the 8-position of 6-chloro-9-methylpurine (**27**) to give a mixture of the adduct **28** and rearomatized purine **29** (Scheme 5).²⁵

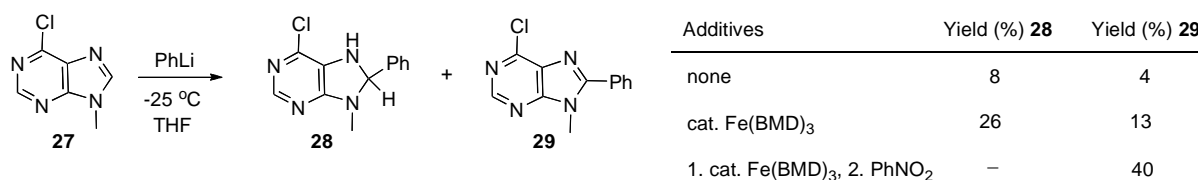

Scheme 5

The reaction is facilitated by catalytic tris(dibenzoylmethido)iron [Fe(BMD)₃] and one pot addition-oxidation can be achieved with nitrobenzene as oxidizing agent. In contrast to these results, 6-chloropurine itself undergoes substitution in the 6-position when treated with phenyllithium (see Section 2.2.1.).²⁶

2.1.2. Addition of organomagnesium reagents

N,N-Dialkylated-2-oxapurines form stable adducts when reacted with Grignard reagents and the products can be rearomatized by DDQ or manganese dioxide. The regioselectivity of the addition is highly dependant on the *N*-alkylation pattern (Schemes 6–9).²⁷

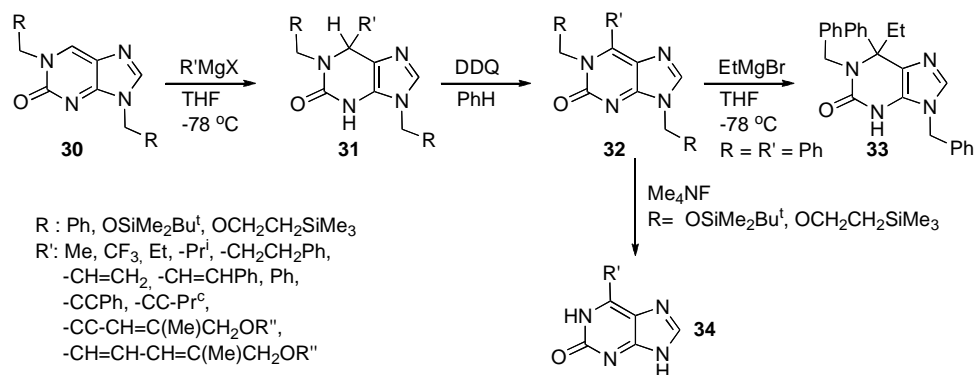

Scheme 6

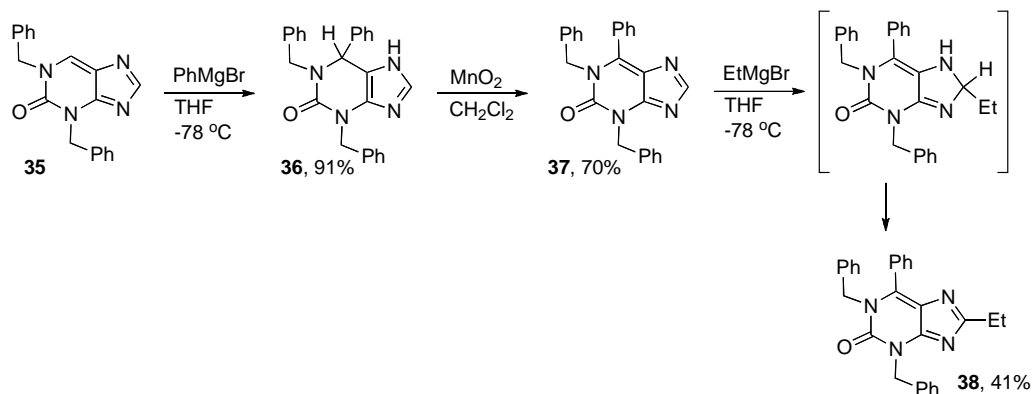

Scheme 7

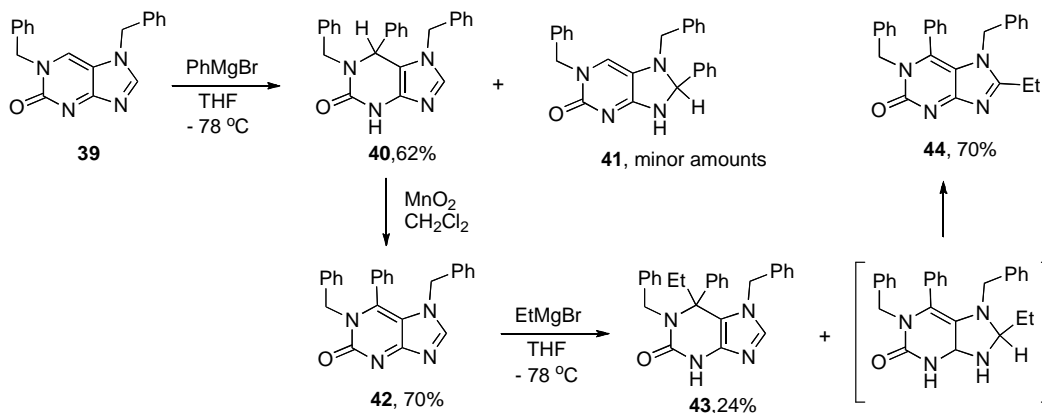

Scheme 8

1,9-Dialkylated 2-oxapurines **30** and **32** react in the 6-position and the adducts **31** and **33** and oxidized compounds **32** and **34** are generally isolated in high yields (Scheme 6).²⁸ 1,3-Dibenzyl-2-oxopurine (**35**) also reacts in the 6-position but the second addition of a Grignard reagent takes place at C-8 and the latter adduct is spontaneously rearomatized to give compound **38** (Scheme 7).^{27a}

Addition of Grignard reagents to 1,7-dibenzyl-2-oxopurine (**39**) was less selective (Scheme 8),^{27a} but attack at C-6 was preferred on the 6-unsubstituted 2-oxopurine **39** and at C-8 when C-6 already carried a substituent (compound **42**). The only dibenzyl-2-oxopurine isomer which preferably adds phenylmagnesium bromide in the 8-position, even if C-6 is unsubstituted, is the 3,7-dibenzylpurine **45** (Scheme 9).^{27a}

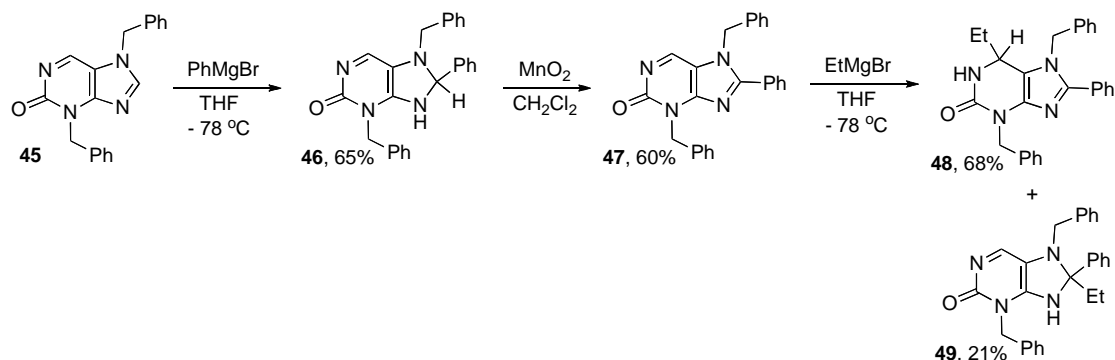

Scheme 9

The trialkylated purinium salt **52**, synthesized as shown in Scheme 10, also reacts selectively with Grignard reagents in the 6-position to give the adducts **53**.²⁸

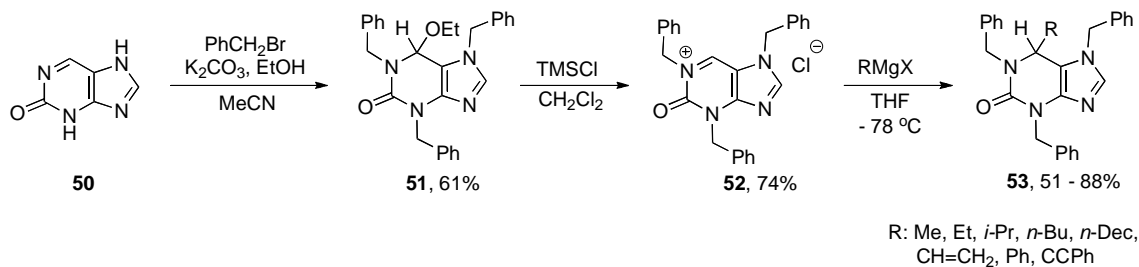

Scheme 10

Introduction of the allyl group at C-8 in 6-chloro-9-tetrahydropyranlyl-purine, probably by an addition-oxidation mechanism, is discussed in Section 2.2.2.²⁹

2.2. Cross-coupling of halopurines

2.2.1. Coupling with organolithium reagents

In most cases, purines are lithiated at C-8 when reacted with organolithium reagents (see Section 2.3.1.), but when 6-chloropurine (**54**) is reacted with 2 equivs. phenyllithium substitution in the 6-position takes place (Scheme 11).²⁶

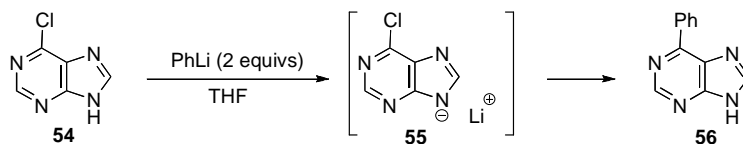

Scheme 11

Since the reaction proceeds *via* the anion **55**, metallation (see Section 2.3.1.) and adduct formation at C-8 (see Section 2.1.1., Scheme 5)²⁵ are precluded.

2.2.2. Coupling with organocuprates-copper-mediated couplings

Copper-mediated coupling reactions are attractive for the introduction of perfluoroalkyl groups, and the first examples of Cu-mediated C–C bond formation in purines were couplings of the organocopper reagent generated from CF₃I and Cu, or CF₃ZnBr and CuBr, with halogenated purine nucleosides **58** (Scheme 12).³⁰ Unfortunately, this method requires the use of highly toxic HMPA and the yields are quite modest. An improved method utilizes trimethyl(perfluoroalkyl)silanes.³¹ Some representative examples are shown in Scheme 12. This latter method was also used for the introduction of the trifluoromethyl group in the purine 2-position.³² Compound **59** has been synthesized in high yield (91%), when the 6-bromo analog of the nucleoside **58c** was treated with FSO₂CF₂CO₂Me and CuI,³³ and the CF₃-group has been introduced at C-2 selectively when a 6-chloro-2-iodopurine was reacted with CF₂Br₂, Zn and CuI, but HMPA was used as co-solvent in both reactions.³⁴

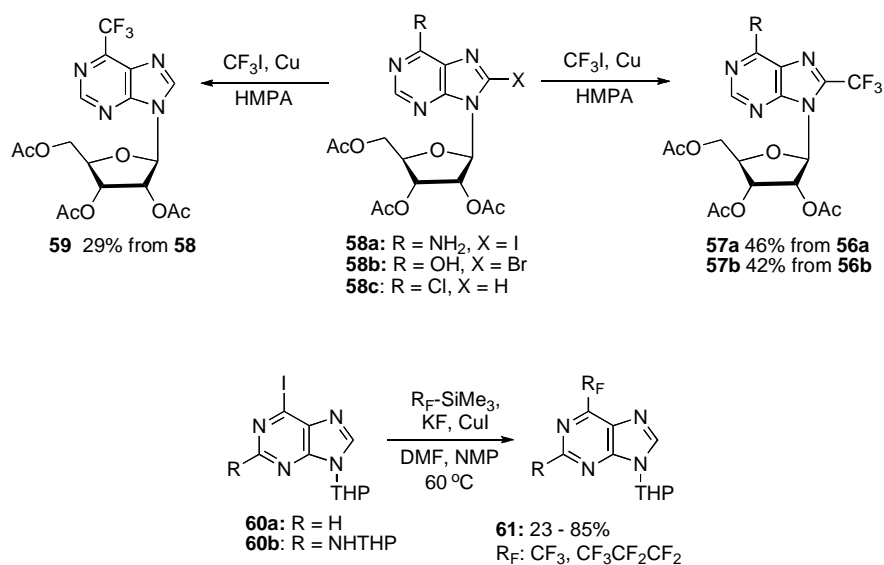

Scheme 12

Also aryl and alkyl groups have been introduced by coupling between 6-halopurines and organocuprates.^{25,29,35} This methodology is especially valuable for the introduction of *sec*- and *tert*-alkyl groups with respect to yield and also when considering other methods for the introduction of such groups, see below. A few representative examples are shown in Scheme 13.³⁵ Interestingly, the allylic reagent reacts at the purine 8-position to give compound **64**, probably by an addition-oxidation mechanism (see also Section 2.1.).²⁹ Cu(I)-mediated dimerization of iodopurines has recently been reported.³⁶

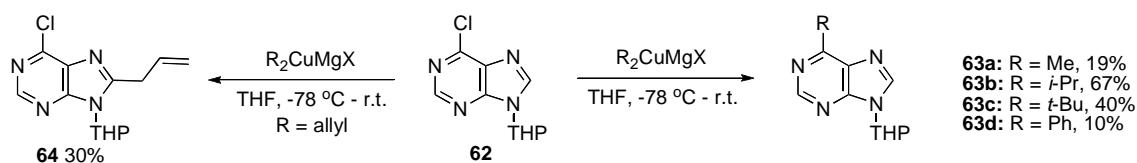

Scheme 13

2.2.3. Coupling with organomagnesium reagents

Addition of Grignard reagents to purines is presented in Section 2.1.2., and copper-mediated coupling of Grignard reagents in Section 2.2.2. Other C–C bond forming reactions involving halopurines and analogs and Grignard reagents are described below. Even though numerous Grignard reagents are easily available, the so-called Kumada-Corriu coupling³⁷ (Pd- or Ni-catalyzed coupling between a Grignard reagent and an aryl- or alkenyl halide or pseudohalide) is rarely employed in purine chemistry. The low chemoselectivity of Grignard reagents and often the need of less stable Ni-catalysts makes the Kumada-Corriu reaction less attractive than the Stille (Section 2.2.4.), Negishi (Section 2.2.5.) or Suzuki-Miyaura coupling (Section 2.2.6.). Ni- or Mn-catalyzed couplings between 6-chloro-³⁸ or 6-methylthiopurines³⁹ and simple aryl, alkyl and homoallyl Grignard reagents have been performed. It is worth noting that the use of relatively basic Grignard reagents is compatible with a free NH function in the purine ring (Scheme 14). Fürstner's Fe-catalyzed coupling of Grignard reagents has been performed successfully on halopurines.⁴⁰ 8-Bromopurines, as well as *O*⁶-tosylpurines, have also been coupled with Grignard reagents in the presence of Pd-catalysts, but the yields are often modest.⁴¹ Some recent examples of a non-catalyzed reaction between 6-iodopurines and Grignard reagents are discussed in Section 2.3.4.

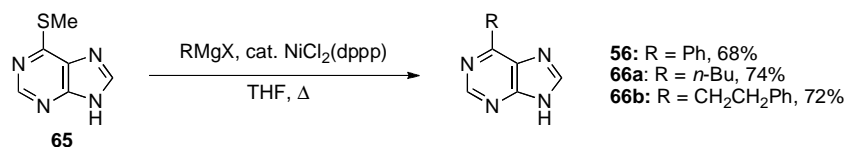

Scheme 14

2.2.4. Coupling with organotin reagents (Stille coupling)

The Stille coupling⁴² is now the most established method for C–C bond formation in purines. Pioneer work was done by Nair, who in the late 1980s demonstrated that 2-iodopurines participate in Pd-catalyzed couplings with various organostannanes and thus synthesized several purine nucleosides with carbon substituents at C-2.^{30b,c,43}

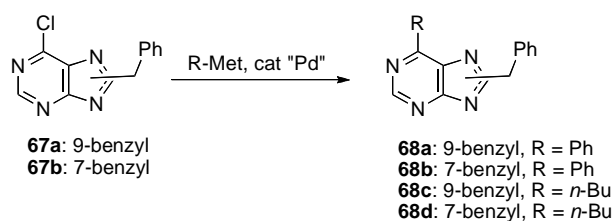

Scheme 15

Table 1. Coupling of 6-chloropurines with organometallic reagents.^{44c,54}

Position of benzyl group	RMet	Solvent	Temp. (°C)	Time (h)	Yield (%)
N-9	PhSnBu ₃	DMF	110	7.0	75, 68a
N-9	PhZnBr	THF	50	0.25	77, 68a
N-9	PhB(OH) ₂	PhMe (K ₂ CO ₃)	100	24	95, 68a
N-7	PhSnBu ₃	DMF	110	4.0	93, 68b
N-7	PhZnBr	THF	50	0.5	84, 68b
N-7	PhB(OH) ₂	PhMe (K ₂ CO ₃)		7.5	70, 68b
N-9	SnBu ₄	DMF	Δ	21	18, 68c
N-9	BuZnBr	THF	50	3.0	84, 68c
N-7	SnBu ₄	DMF	Δ	3.5	65, 68d
N-7	BuZnBr	THF	50	2.0	24, 68d

Soon afterwards the first examples of Stille couplings in the purine 6-⁴⁴ and 8-positions⁴⁵ appeared. Protocols for selective couplings on dihalopurines were established (see Section 2.2.11.)⁴⁶ and soon Stille couplings became the method of choice for the introduction of aryls and alkenyls in the purine 2-,⁴⁷ 6-^{31b,47h,48} and 8-position.^{47b,h,48u,49}

7-Alkylated 6-chloropurines **67b** are more reactive in Stille couplings than the corresponding *N*-9 alkylated isomer **67a** (Scheme 15, Table 1), the opposite is found in Negishi couplings (Section 2.2.5.).^{44c} Alkyl groups could also be introduced this way, but in most cases the Negishi coupling, employing more reactive organozinc compounds (Section 2.2.5.) would be preferred. Alkynyltin reagents react well in Stille couplings on purines, but generally the environmentally more benign Sonogashira coupling (Section 2.2.9.) would be the method of choice for these transformations.

2.2.5. Coupling with organozinc reagents (Negishi coupling)

Couplings between organozinc compounds and halopurines were first reported in 1994; the *N*-benzyl-6-chloropurines **67** reacted with aryl and alkylzinc halides in the presence of a Pd-catalyst (Scheme 15).^{44c} For *N*-alkylated purines this is probably the most convenient way to introduce alkyl groups at C-2, C-6 or C-8, transformations which require harsh conditions employing organotin reagents, see for instance synthesis of compound **68c** (Scheme 15, Table 1) and currently there are numerous reports of Negishi couplings⁵⁰ on halopurines.^{40b,46a,c,47h,48q,49k,51} Nitrile group has been introduced at all purine carbons by Pd-catalyzed coupling with Zn(CN)₂.⁵² Scheme 16 shows the application of the Negishi and Stille reaction in the synthesis of a cyclic tetrameric purine **78**, isolated as a Pd-complex.⁵³ The purine metallation and regioselectivity involved in the synthetic sequence are discussed in Sections 2.3.2. and 2.2.11., respectively.

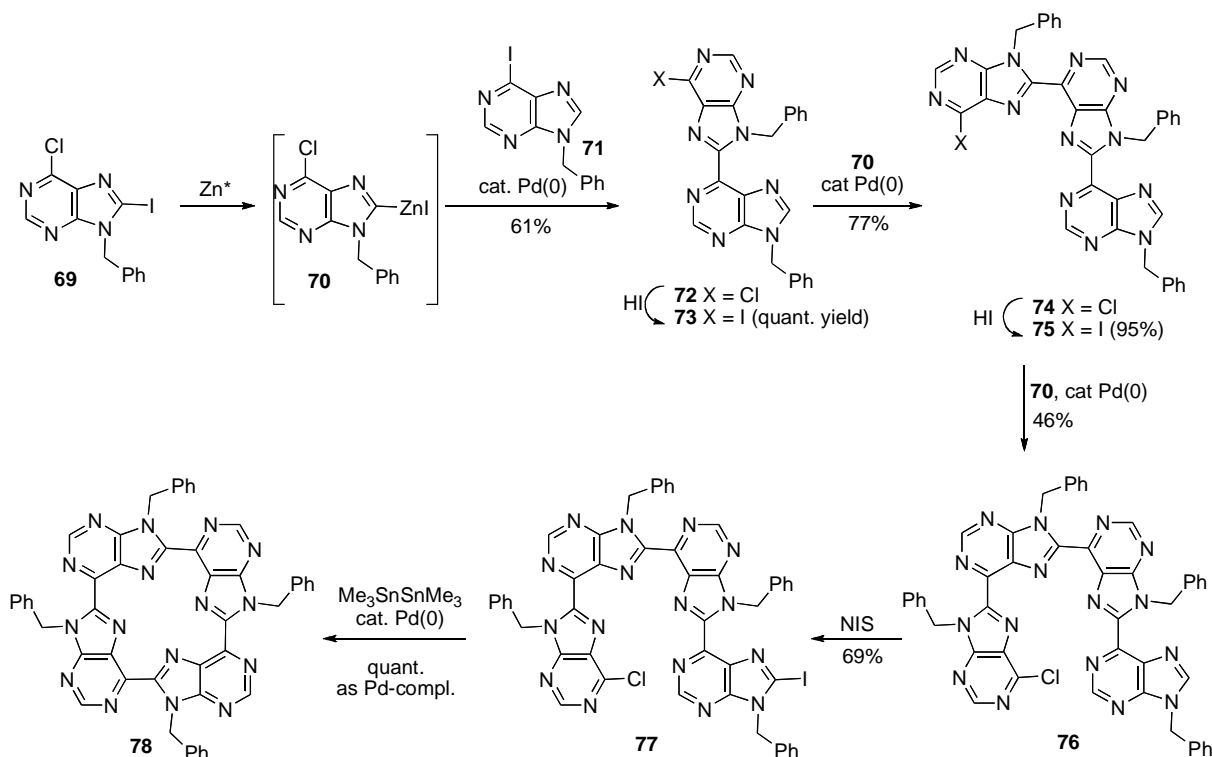

Scheme 16

2.2.6. Coupling with organoboron reagents (Suzuki-Miyaura coupling)

9-Benzyl-6-phenylpurine (**68a**) has been synthesized in excellent yield in a reaction between the corresponding 6-chloropurine **67a** and phenylboronic acid in the presence of catalytic Pd(0) (Scheme 15, Table 1). A facile introduction of alkenyl groups was also achieved by this strategy and electron deficient arylboronic acids reacted satisfactory when the solvent was changed from toluene to DME.⁵⁴ The Suzuki-Miyaura⁵⁵ coupling is now routinely used for functionalization in the purine 2-,^{40b,51e,52c,56} 6-^{31b,c,32,40c,41b,48f,k,49q,r,51e,f,n,52b,56b,m,n,57} and 8-position.^{40c,49h,57l,m,58} Aryl and, to a certain extent, alkenyl groups are conveniently introduced. In most cases reported, the Suzuki-Miyaura coupling is performed on halopurines, but also *O*⁶-sulfonates^{41b,57c,57j} and 6-azolylpurines^{57h} have participated in the reaction even though a more active catalytic system [Ni(0) with imidazolium carbene ligands] may be required. The same is true for coupling on 6-fluoropurines.^{57j}

The Suzuki-Miyaura reaction is, together with the Stille reaction, currently the most popular method for the introduction of aryl or heteroaryl substituents in the purine 2-, 6- or 8-position. The choice of method is often governed by the availability of the desired organometallic coupling partner. The Suzuki-Miyaura coupling may be regarded as environmentally more benign, compared to the Stille coupling where organotin compounds are employed.

Synthesis of 8-aryl adducts of adenine and guanine nucleosides, formed by reaction of radical cation metabolites of carcinogenic polycyclic aromatic hydrocarbons (PAHs), has been attempted by coupling between 8-bromonucleosides and the required arylboronic acid. Boronic acids **80a–c** gave the 8-aryladenine derivatives **81a–c**^{58p} (Scheme 17), or the corresponding guanines,^{58l} but the more sterically hindered boronic acids **80d–f** failed to participate in the coupling, instead they underwent hydrolytic deboration.

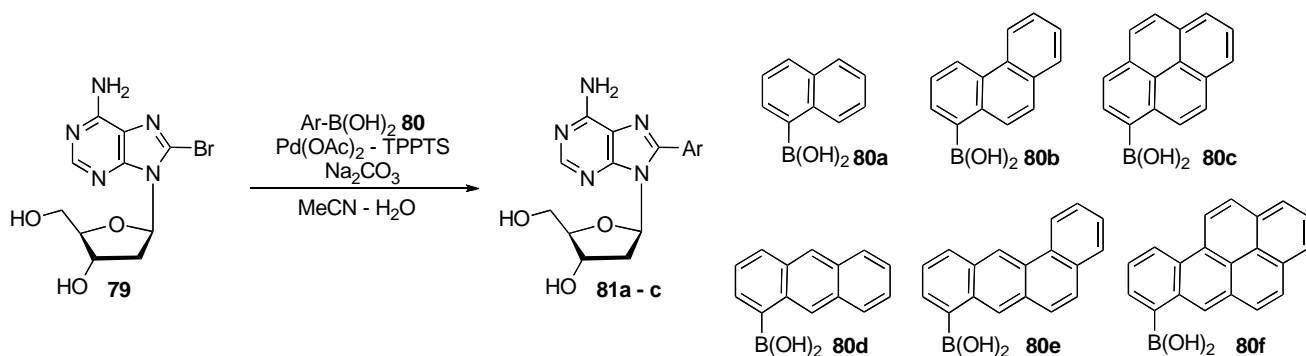

Scheme 17

2.2.7. Coupling with organoaluminium reagents

Since first described more than 15 years ago,⁵⁹ coupling between halopurines and trialkylaluminium species has been employed only occasionally.^{31b,32,40b,d,47f,48s,51f,o,56j,n,60} Trialkylalanes have a quite limited stability and relatively few are commercially available. Since organozinc compounds in general are easier to generate and handle, the Negishi coupling (Section 2.2.5.) is a far more convenient method for the introduction of alkyls at C-2, C-6 or C-8. Reductive dehalogenation, rather than coupling is also reported for Pd-mediated reaction between halopurines and triisopropylaluminum and tributylaluminum^{47f} and it seems to be difficult to obtain regioselective reactions on di- or trihalopurines.^{40b,d,56i}

2.2.8. Heck coupling

The Heck reaction,⁶¹ Pd-mediated coupling between an alkene and, for instance, an aryl or heteroaryl halide, would be an attractive method for the synthesis of alkenylpurines, since no organometallic coupling partner is required, as opposed to the Stille, Negishi or Suzuki-Miyaura reactions. Even though Heck couplings have been frequently carried out on heteroaryl halides,⁶² the only known examples of Heck couplings on purines are the reactions shown in Scheme 18.⁶³ Relatively harsh conditions were required and the products **83**^{63a} and **85**^{63b} were isolated in moderate yields. Reaction between the 6-halopurines **67** and **71** and Michael acceptors in the presence of thallium- or silver-acetate (Scheme 19) lead to *N*-1 substituted hypoxanthines **86** instead of 6-alkenylpurines⁶⁴ and reductive Heck coupling, leading to the regioisomers **87** and **88**, took place in the presence of formic acid (Scheme 19).⁶⁵

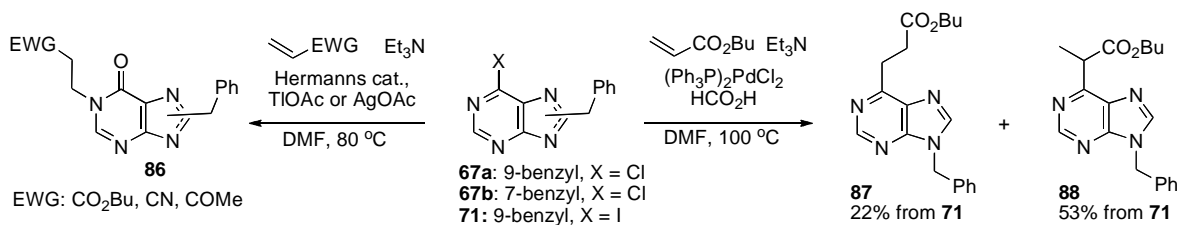
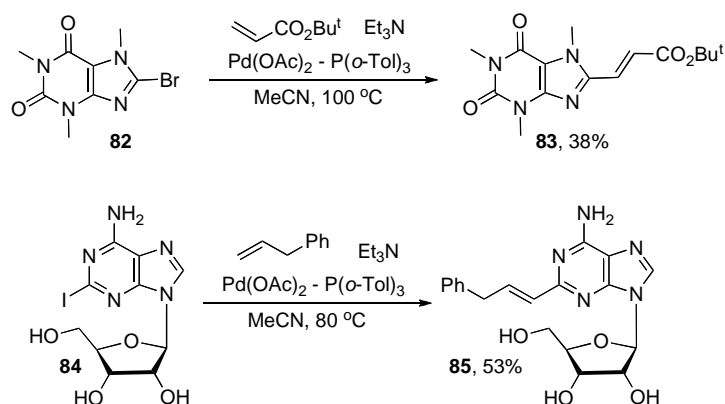

2.2.9. Sonogashira coupling

One of the earliest examples of palladium catalyzed coupling reactions performed on halopurines are syntheses of 2-, 6- and 8-alkynylpurines⁶⁶ employing the Sonogashira reaction,⁶⁷ coupling of terminal alkynes in the presence of catalytic Pd(0) and Cu(I) as well as base.

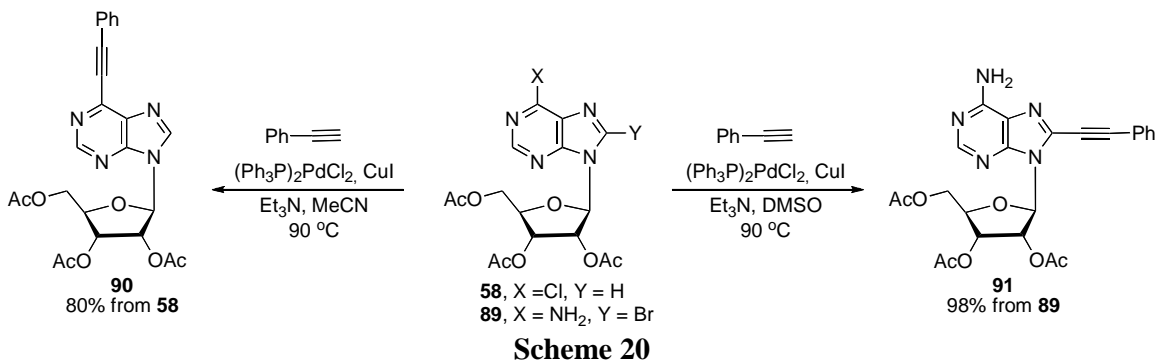

Some of the first examples are shown in Scheme 20.^{66a} The reaction has been used extensively for the introduction of alkynyl substituents in the purine 2-,^{1b,38b,47d,h,51e,52c,56d,f,g,63b,68} 6-^{1b,48d,51d,e,57g,68a,s,69} and 8-position.^{1b,49g,m,58h,q,r,68a,t,69a,70} Not only are many alkynylpurines associated with interesting bioactivities (See Section 4.), but alkynylpurines are often useful intermediates in the synthesis of other purine derivatives (See Section 2.2.12.).

2.2.10. Direct CH alkylation and arylation

The so-called heteroaryl Heck reaction has been utilized for direct CH arylation of a number of heterocycles⁶² and recently purine (**1**) was coupled to neohexene by Rh-mediated CH activation (Scheme 21).⁷¹ Also C-8 arylation of purines **68a** and **92** (Scheme 22),^{56m} as well as purine nucleosides⁷² have been carried out. In both cases, some coupling in the purine 6-position (when unsubstituted) took place as well.

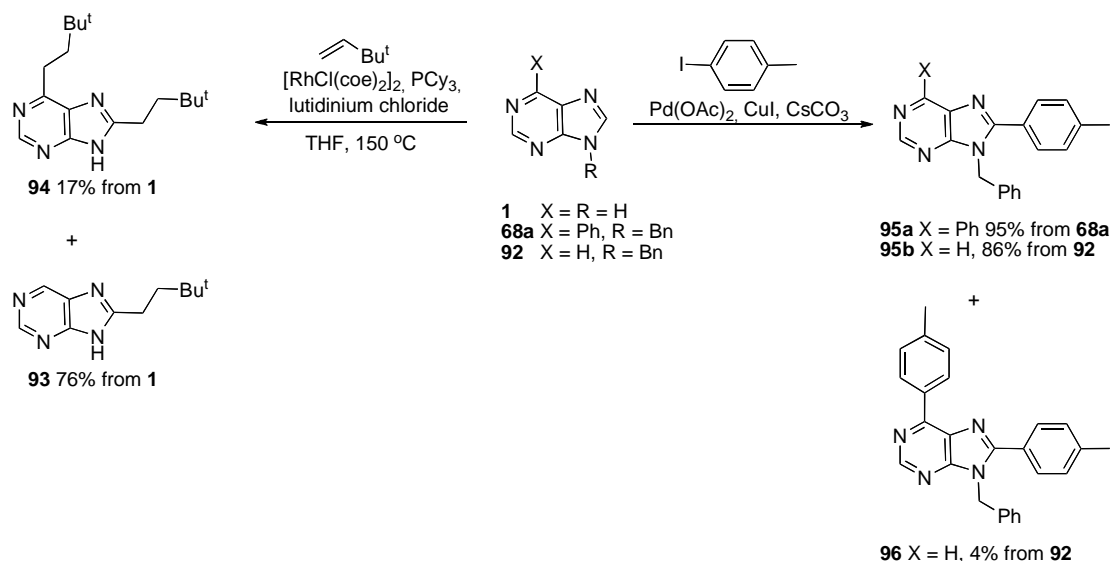

Scheme 21

2.2.11. Regioselectivity in cross coupling reactions of dihalopurines

Coupling takes place in the 6-position when 2,6- **97a** or 6,8-dichloropurines **101a** are subjected to Stille coupling under mild conditions. The selectivity is reversed when more reactive halogens are introduced in the 2- or 6-position (Scheme 22).⁴⁶

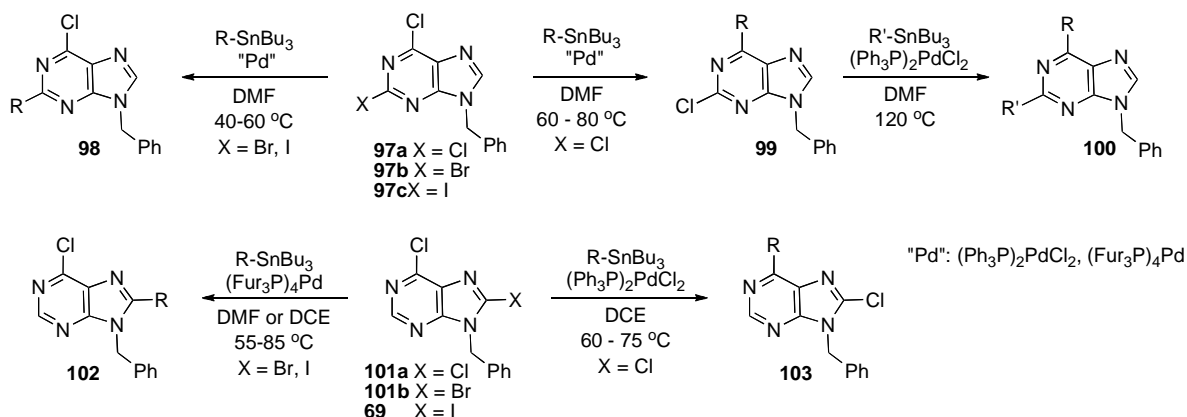

Scheme 22

The same trends are generally observed in couplings with other organometallic reagents, but in case of trialkylaluminium reagents it appears that selective monoalkylation of di- or tri-halopurines is not possible.^{40b,d,56j}

2.2.12. Further transformation of coupling products

Especially alkynyl- and alkenylpurines, formed by any of the coupling reactions discussed above, may be valuable intermediates in the synthesis of a wide variety of purine derivatives. Early work on alkynes includes for instance selective reduction to *Z*-alkenylpurines, reduction to fully saturated alkylpurines and Hg-mediated transformation to methylketones. Benzofuryl purine **104** and benzofurylidene purines **105** and **106** are available from reaction between iodopurine **71** and alkynes under Sonogashira condition (Scheme 23).

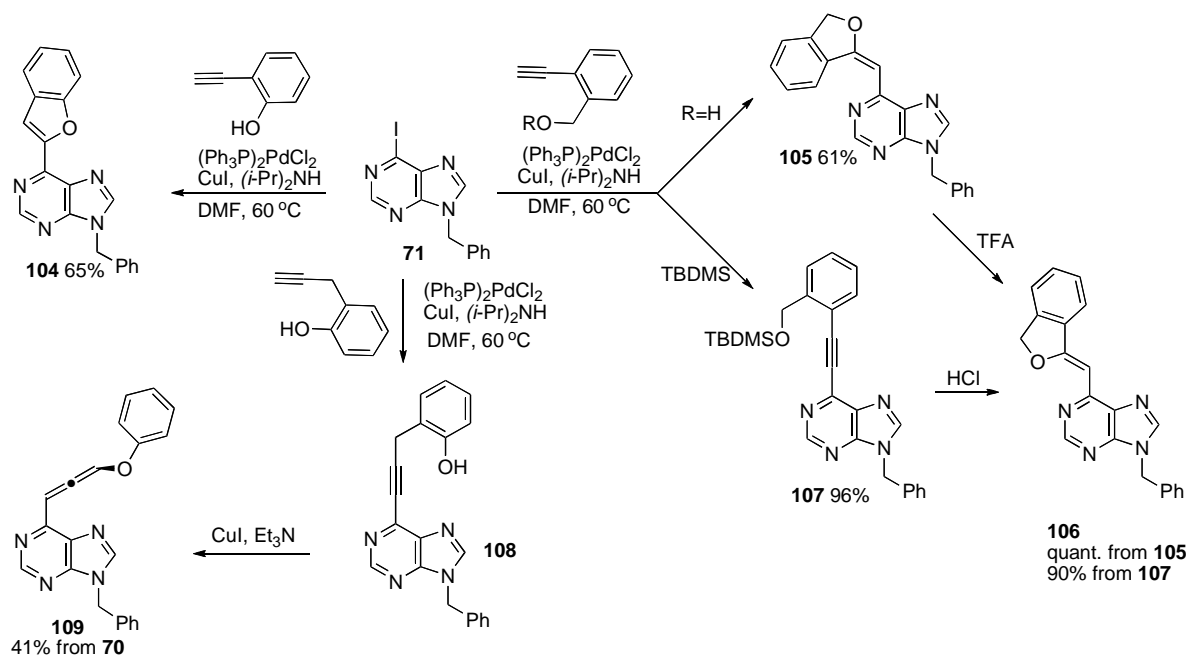

Scheme 23

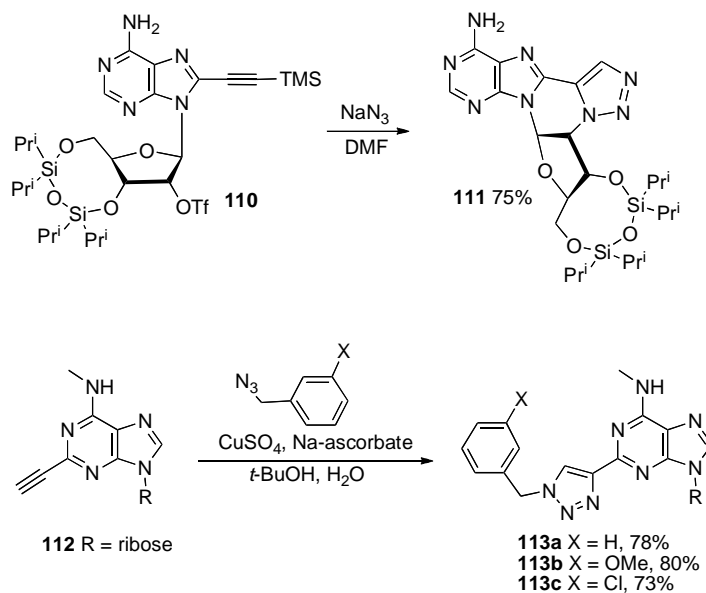

Scheme 24

The alkyne **108** did not cyclize, but unexpectedly rearranged to the allene **109**.^{69d} Triazolypurines (for instance **111** and **113**, Scheme 24) have been synthesized by Huisgen-type [3+2]-cycloaddition on alkynylpurines,^{68w,70u} and 6-alkynylpurines have been subjected to cyclotrimerization; one example is shown in Scheme 25.⁷³

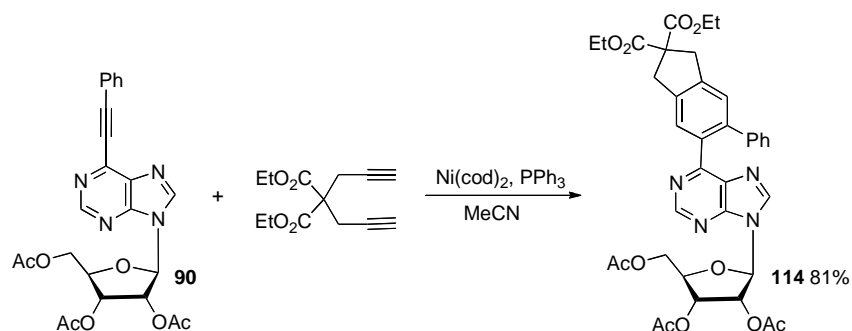

Scheme 25

6-Alkenylpurines are electron deficient alkenes and thus undergo nucleophilic addition^{48b} and Diels-Alder reactions^{48a} as well as participate in Heck couplings^{48d} (Scheme 26). Also 8- and 2-vinyl purines participate in addition and cycloaddition reactions.^{47b}

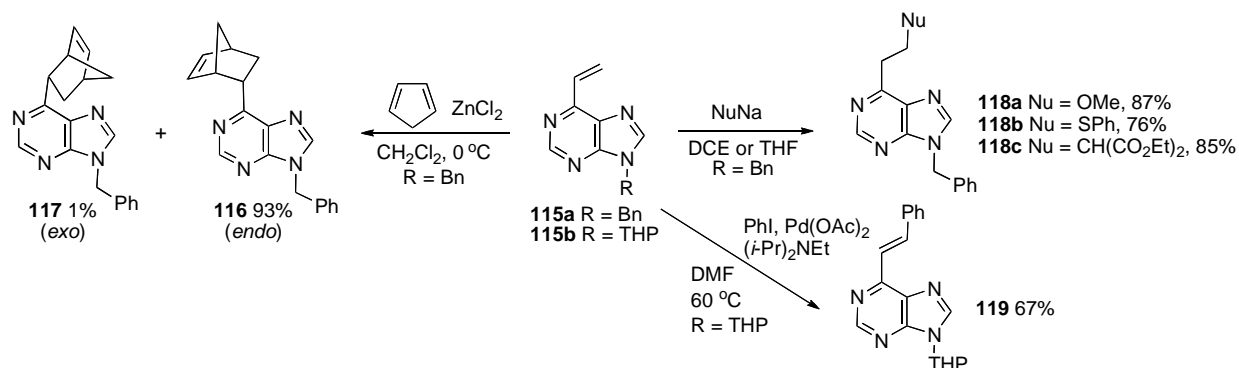

Scheme 26

2.3. C–C Bond formation *via* metallated purines

2.3.1. Generation and reactivity of lithiated purines

Several purines and purine nucleosides have been subjected to direct lithiation in the 8-position when treated with BuLi,⁷⁴ or preferably LDA⁷⁵ and the metallated purines have been trapped with a variety of electrophiles including simple alkyl halides and aldehydes. Metal-halogen exchange on 8-bromopurine nucleosides was also reported.⁷⁶ 2-Lithiated purines may be generated when the 8-position is protected with the TIPS-group and trapped with carbon electrophiles (Scheme 27).⁷⁷ An electron withdrawing chloride at C-6 is required for lithiation at C-2 and unfortunately HMPA is employed in the TIPS-introduction step. 6-Lithiopurine **126** has been generated when iodopurine **60a** is treated with BuLi, but the compound rearranged to the more stable 8-lithiated purine **127**, even at -70 °C (Scheme 27).^{74b}

2.3.2. Generation and reactivity of stannylated purines

2-Stannylated purines are available by lithiation of 6-chloropurines with an excess LTMP and trapping with an excess Bu₃SnCl (Scheme 28)⁷⁸ and the 2-stannylpurines have been subjected to Stille

couplings^{56d,78,79} and reactions with acid chlorides.⁷⁸ The proposed mechanism for the formation of 2-stannyl or 2-silyl purines is shown in Scheme 29.⁷⁸ 2-Stannyl-⁸⁰ and 8-stannylpurines (Scheme 16)⁵³ have also been synthesized by Pd-catalyzed coupling between halopurines and hexaalkylditin.

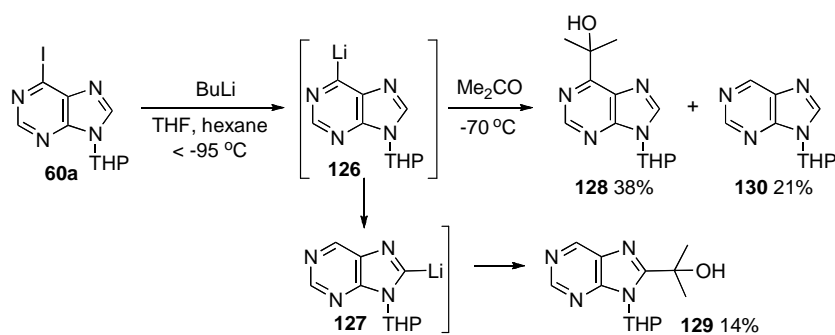
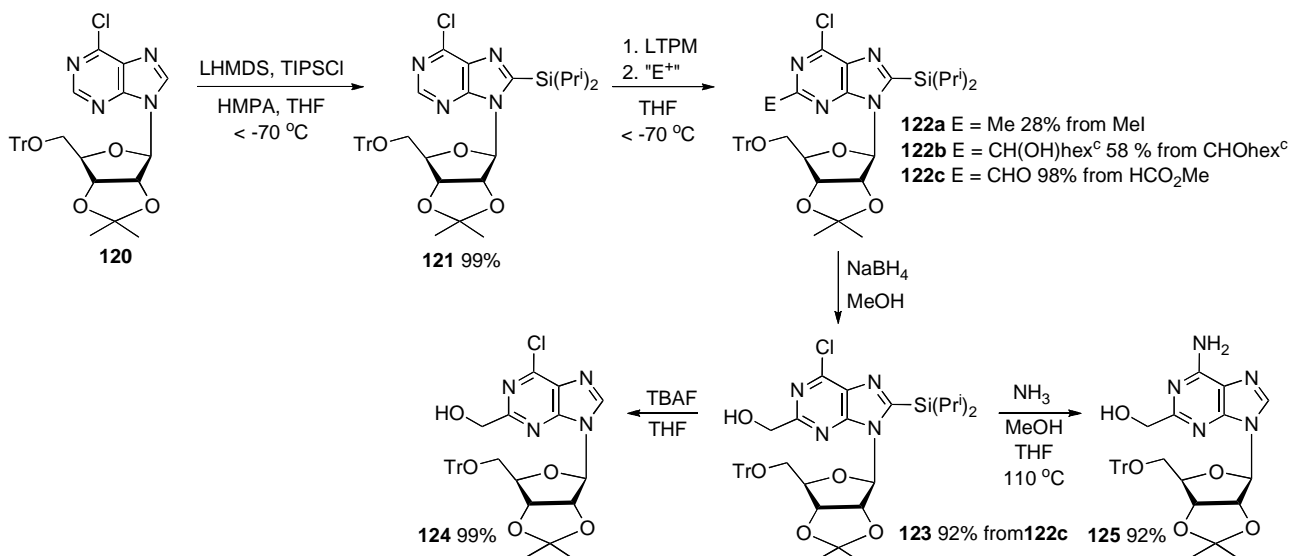

Scheme 27

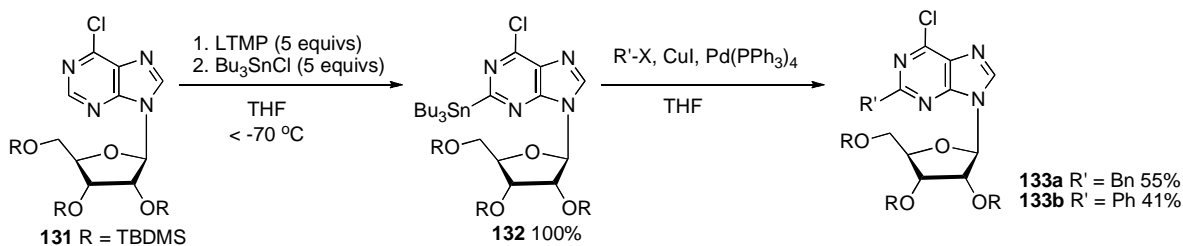

Scheme 28

2.3.3. Generation and reactivity of zincated purines

6-Iodopurines have been converted to organozinc species by direct insertion of zinc dust. In contrast to 6-lithiated purines (Section 2.3.1., Scheme 27), no rearrangement took place and the zincated purines underwent Pd-catalyzed cross couplings with aryl iodides (Scheme 30).^{51a,81} This methodology has not been utilized extensively in purine chemistry, but an example of zincation and coupling at the purine 8-position can be seen in Scheme 16.⁵³

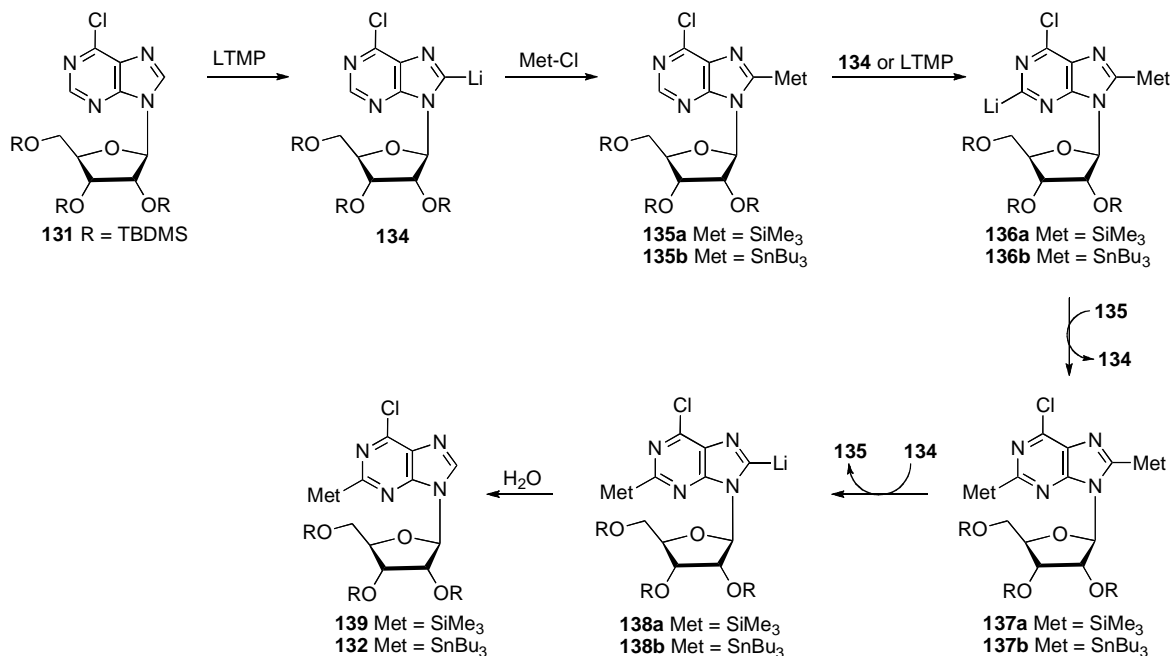

Scheme 29

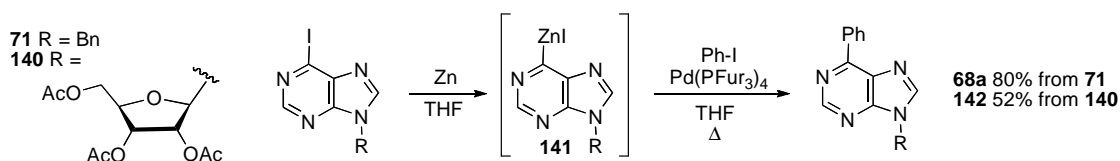

Scheme 30

2.3.4. Generation and reactivity of magnesiated purines

Treatment of 6-iodopurines with isopropylmagnesium chloride at $-80\text{ }^{\circ}\text{C}$ gives the magnesiated purines **144**, which can be trapped with aldehydes (Scheme 31), but which do not react with ketones, nitriles and esters. The purin-6-ylmagnesium compounds **144** are far more stable than the corresponding lithiated purine **126**^{74b} (Section 2.3.1., Scheme 27) and migration of Mg to C-8 was not observed even at room temperature, even though slow decomposition to unknown compounds took place above $0\text{ }^{\circ}\text{C}$.⁸²

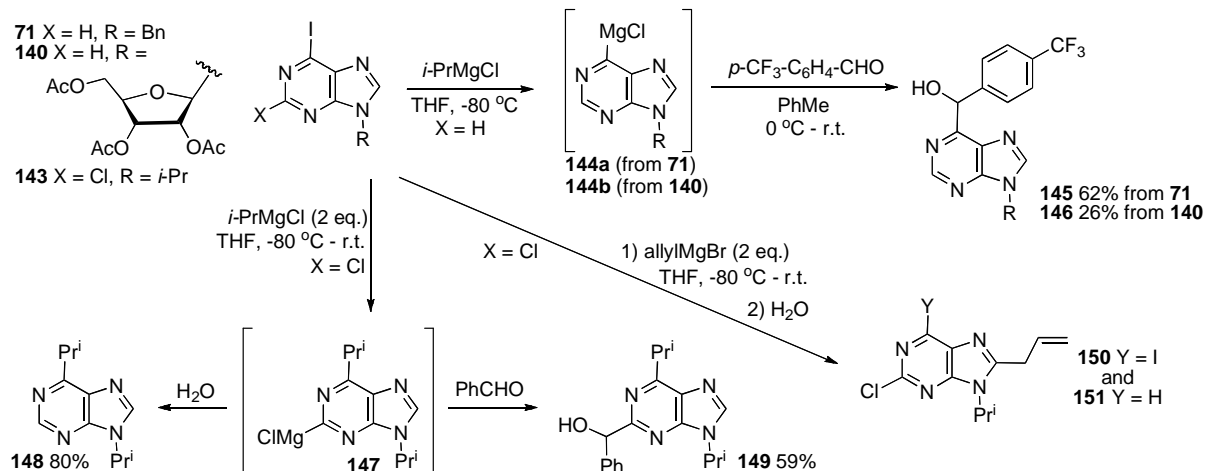

Scheme 31

6-Chloropurines did not react with *i*-PrMgCl, but, when the dihalopurine **143** was reacted with 2 equiv. of *i*-PrMgCl, compound **148** or **149** is obtained depending on quenching conditions.⁸³ It is postulated that the products are formed *via* the organomagnesium species **147**, meaning that not only a chloropurine participated in metal-halogen exchange, but also the Grignard reagent reacted with the iodopurine in an uncatalyzed substitution (For a discussion of other reactions between halopurines and a Grignard derivative, see Section 2.2.3.). Several Grignard reagents react with compound **143** in a similar way giving products structurally related to purines **148** and **149**. However, allylmagnesium bromide reacted at the purine 8-position to give a mixture of the 8-allylpurines **150** and **151**.⁸⁴ It is worth noting that also an allylic cuprate is reported to add in the purine 8-position (see formation of compound **64**,²⁹ Scheme 13). The Grignard reagent **144a** has also been reacted with allylic halides in the presence of catalytic CuI, but the yield of the 6-allylpurines are generally modest (7–54% depending on the allylic halide).⁸⁴

2.3.5. Generation and reactivity of palladated purines

6-Chloropurine **67a** was allowed to react with Pd(PPh₃)₄ in order to gain more knowledge of mechanistical aspects regarding Pd-catalyzed cross-couplings between halopurines and organometallic reagents (Section 2.2.). The monomer **152** and dimer **153** were formed in a 9:1 ratio (Scheme 32).⁸⁵ After treatment with H₂O₂, the dimer **153** could be isolated. The complex **153** reacted with PhSnBu₃ to give the coupling product **68a**. Dimer **153** also catalyzes Stille coupling between chloropurine **67a** and PhSnBu₃ to give the coupling product **68a** in essentially the same yield as when the conventional catalyst (Ph₃P)₂PdCl₂ was used under otherwise identical conditions.

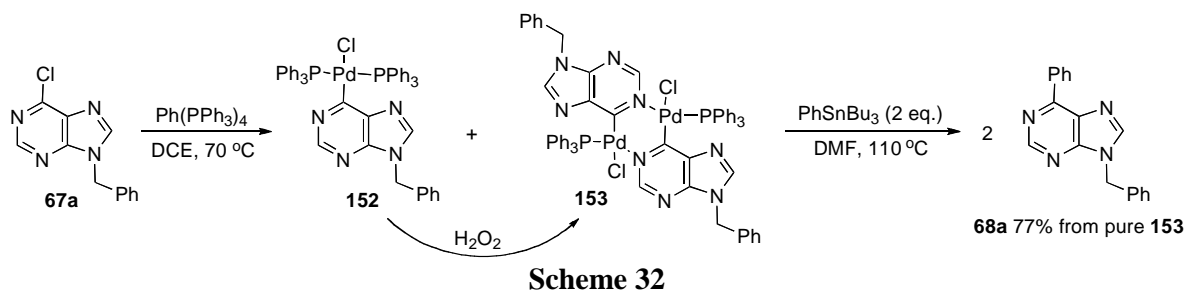

3. C–N Bond formation

3.1. Buchwald-Hartwig reaction

The Buchwald-Hartwig reaction,⁸⁶ Pd-catalyzed coupling between an aryl halide (or pseudohalide) and a primary or secondary amine in the presence of a base, have been employed in purine chemistry. Coupling between halopurines and amines are discussed in Section 3.1.1. and between aminopurines and aryl halides in Section 3.1.2. Some of the early work has been reviewed before.^{24a}

3.1.1. Buchwald-Hartwig reaction on halopurines

Even though halopurines often may be converted to aminopurines simply by substitution reactions with the required primary or secondary amine or ammonia,^{1b} Pd-catalyzed Buchwald-Hartwig coupling between halopurines and amines may be the preferred method when the transformation requires a sensitive or sterically hindered amine. The reaction was first applied in purine chemistry in a synthetic study directed towards spiramycins (Scheme 33)⁸⁷ and soon after the syntheses of spiramycin aminonucleoside (**157**)⁸⁸ and spiramycin VIII (**158**)⁸⁹ were completed.

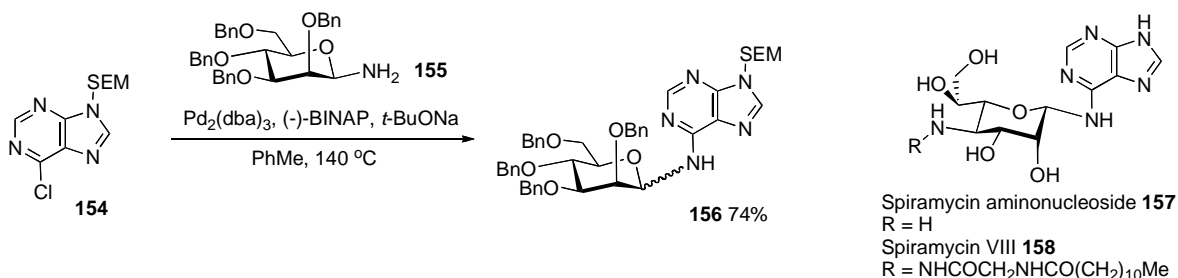

Scheme 33

Almost simultaneously a 2-bromopurine was coupled with a 2-aminopurine under Buchwald-Hartwig conditions⁹⁰ and the process turned out to be a valuable method for synthesis of cross-linked nucleosides and nucleotides.⁹¹ This also constitutes the first example of the reaction applied on an aminopurine and it is discussed further in Section 3.1.2. Pd-catalyzed coupling between amines and 2-, 6- and 8-halo- or pseudohalopurines have become a popular way to synthesize aminopurines,^{56a,c,e,92} especially couplings with aryl amines directed towards products resembling those formed from reactions with mutagenic and carcinogenic compounds.^{58i,91c,93} Fine-tuning of reaction conditions has allowed coupling under much milder conditions than those reported in the early example shown in Scheme 33. Less nucleophilic *N*-compounds, like amides,⁹⁴ pyrrole (**159**)^{48q} (Scheme 34) and other azoles⁹⁵ also participate in these kinds of C–N bond forming reactions. Amide synthesis by Pd-catalyzed coupling of amines with 2-iodopurines in the presence of CO is also reported.^{94c}

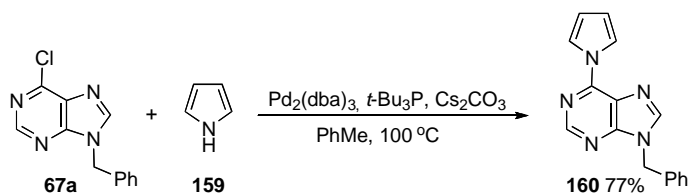

Scheme 34

3.1.2. Buchwald-Hartwig reaction on aminopurines

The first examples of Buchwald-Hartwig coupling on an aminopurine was Pd-catalyzed coupling between the 2-bromopurine **161** and the 2-aminopurine **162** (Scheme 35)^{90,91a} leading to cross-linked nucleosides and nucleotides.⁹¹ The yield of compound **163** was increased to 90% when Cs₂CO₃ was employed as base.^{91b}

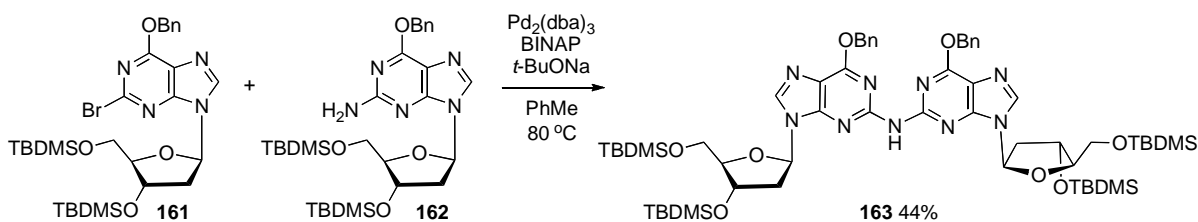

Scheme 35

Just as the reversed strategy (Section 3.1.1.), Buchwald-Hartwig coupling on aminopurines has also been used in syntheses of mutagenic and carcinogenic compounds.^{92,96} The method of choice depends on the

availability and reactivity of the coupling partner. The latter factor is not easily predicted. Recent results indicate that the Xantphos ligand compares favorably to BINAP in couplings on aminopurines.^{93e,93f} Related Cu-mediated reactions are discussed in Section 3.2.

3.2. Cu-mediated *N*-arylation

*N*⁶-Arylation of deoxyadenosine (**164**) has been achieved when the adenine was reacted with aryl halides in the presence of stoichiometric amounts of CuI and DMEDA.^{93n,97} One example is shown in Scheme 36.⁹⁷ Purine itself (**1**) has been arylated at *N*-9 under similar reaction conditions, only with catalytic amount of CuI and a different diamine ligand (Scheme 36).⁹⁸

Another method for *N*-arylation of purines is the Cu-mediated reaction with arylboronic acids. Purines can be arylated at *N*-9 with complete regioselectivity,^{48n,56c,99} as shown in Scheme 37. Phenylation of 6-mercaptapurine **22** gave the diarylated product **168b**, but the primary amino group in compound **167** was unaffected. Even though the conversion in this reaction was lower, no *N*²-arylation was observed.^{99a} The 9-benzyl derivative of compound **167** (compound **169**) has been *N*²-arylated under relatively similar conditions (Scheme 37).¹⁰⁰ Also *N*-9 alkenylation of purines has been achieved.^{99c} Low yield *N*-9 arylation employing arylboronic acids without Cu-catalysis is reported under microwave conditions.¹⁰¹ Guanosine derivatives are arylated at *N*-1,¹⁰² again demonstrating a preference for reaction at ring nitrogens in Cu-mediated *N*-arylation reactions.

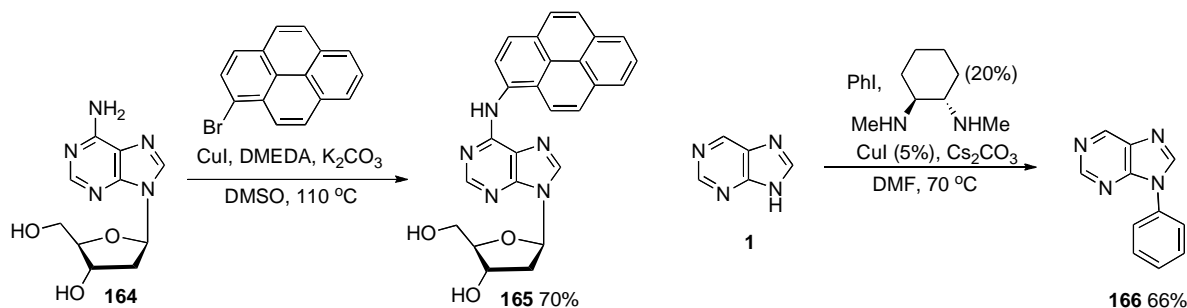

Scheme 36

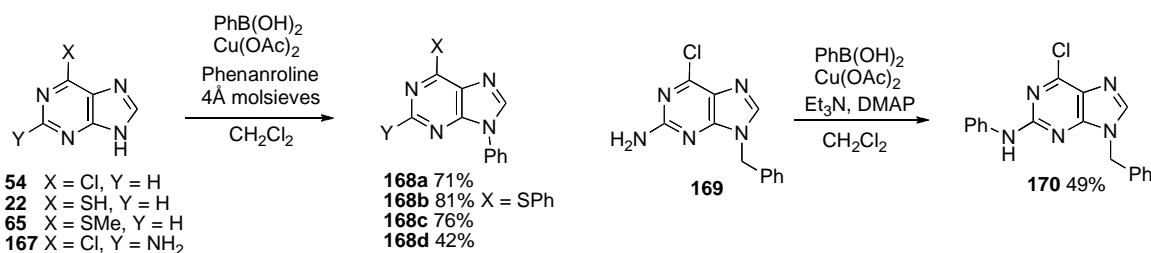

Scheme 37

3.3. Palladium(0)-mediated *N*-allylation

(-)-Aristeromycin **173**, an antibiotic carbocyclic nucleoside found in *Streptomyces* sp. (), was synthesized as a racemate by a Pd(0)-catalyzed *N*-allylation (Trost-Tsuji reaction¹⁰³) of adenine **3** with the epoxide **171** as a key-step (Scheme 38).¹⁰⁴

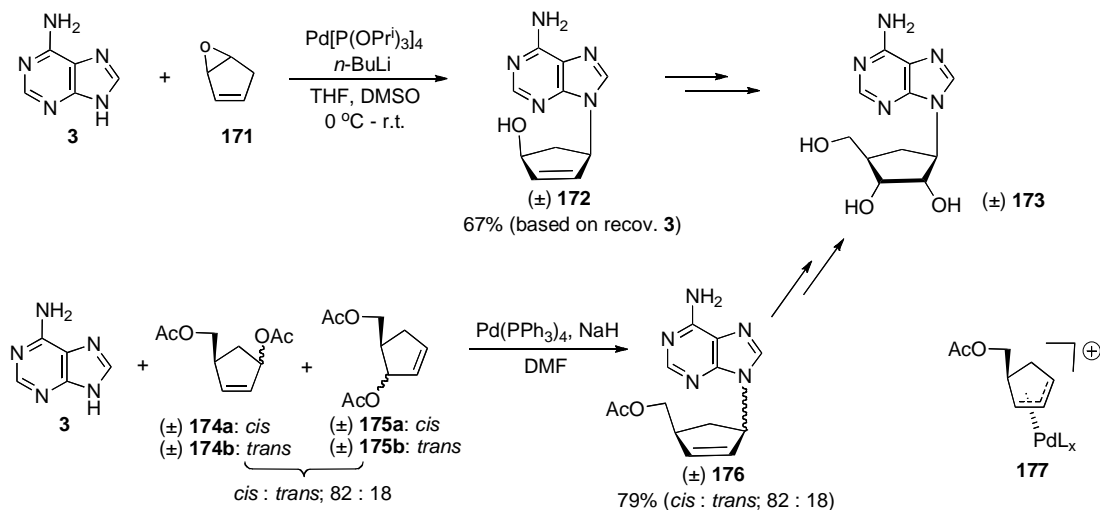

Scheme 38

Soon thereafter, (±)-**173** was synthesized from a mixture of allylic acetates (±)-**174** and (±)-**175**, which gave compound (±)-**176** with the same *cis-trans* ratio as in the mixture of acetates in the *N*-allylation step. Only the regioisomer (±)-**176** is formed since the reaction proceeds *via* the palladium-complex (±)-**177** which is attacked by the purine nucleophile at the least hindered allylic carbon (Scheme 38).¹⁰⁵ (+)-Allyl acetate **174a** gave *ent*-aristeromycin¹⁰⁶ and (–)-Aristeromycin **173** have been synthesized from a close analog of (–)-**175a** (carbonate instead of acetate).¹⁰⁷

In addition to synthesis of natural products like aristeromycin **173** and neoplanocin A **21**¹⁰⁸ (for structure, see Scheme 3), Pd-catalyzed allylic alkylation has been used extensively in synthesis of anti-HIV compounds like carbovir (**182**),^{107,109} the current drug abacavir (**183**)^{109l,m} (Scheme 39), as well as numerous carbocyclic analogs^{60a,110} and also some dihydrofurans and pyranes.¹¹¹ The guanine derivative **178** compares favorably to the chloride **167** with respect to regioselectivity (*N*-9 *vs* *N*-7) in the *N*-allylation step. The silicon based *O*⁶-protecting group is cleaved under very mild conditions (Scheme 39).^{109b,c}

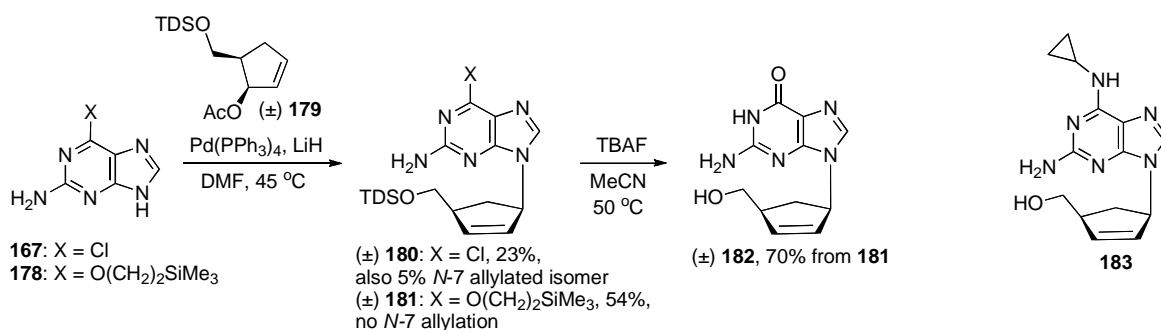

Scheme 39

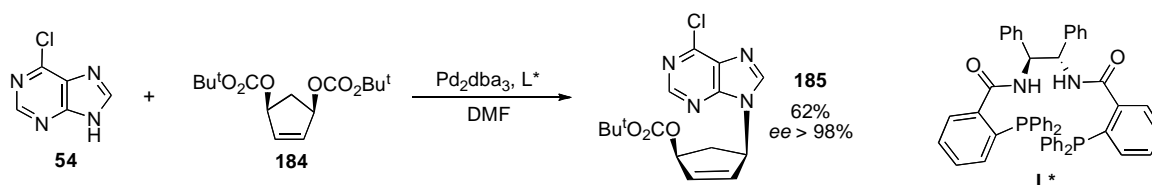

Scheme 40

Enantiopure carbocyclic nucleosides are in most cases synthesized from enantiopure allylic acetates or carbonates. However enantioselective allylation has been achieved when the desired purine was reacted with a *meso*-diester or carbonate **184** as shown in Scheme 40.^{109i,j}

4. Biological activities

The development of metal-mediated methods for facile C–C and C–N bond formation in purines has, of course, allowed synthesis of a wide variety of derivatives, many of which exhibits interesting biological activities. It is beyond the scope of this text to cover all examples, only selected areas related to the authors own research are presented below.

4.1. Cytotoxic purines

As mentioned in the introduction, several purines are clinically used as anticancer drugs, for example the antimetabolites 6-mercaptopurine (**22**)¹⁷ and fludarabine phosphate (**23**)¹⁸ (for structures, see Scheme 4). We found that 6-alkynylpurines **31**, **32** or **186**,^{27d,48l} and to some extent 6-alkenylpurines **187**^{48l} exhibit profound cytotoxic activity against chronic myelogenous leukemia cells (K-562) (Scheme 41). The alkynes **31** and **32** were synthesized by addition of Grignard reagents to oxopurines followed by rearomatization (compounds. **32**) as described in Section 2.1.2.^{27d} The alkynyl groups in compounds **186**^{48l} were introduced by Sonogashira coupling (Section 2.2.9.) and the alkenylpurines **187**^{48l} were formed by Heck coupling on 6-vinylpurines (Section 2.2.12.). Since related alkylpurines were found to display only weak cytotoxic activities and 6-alkenyl- and alkynylpurines are prone to nucleophilic attack (Section 2.2.12.), we speculated that the compounds **31**, **32**, **186** and **187** exhibited their toxicity by reaction with nucleophilic sites in biomolecules. It is worth noting that nucleosides **188**, which can be regarded as amine adducts of 6-alkynyl- or alkenylpurines also have been associated with cytotoxicity against cancer cell lines.^{48m,69f} Also 6-aryl- or heteroarylpurines, synthesized mainly by Suzuki-Miyaura coupling (Section 2.2.6.),^{51n,57a,f} (see for instance compound **189**^{57f} in Scheme 41) and 8-alkynyl arylpurine nucleosides^{70e} synthesized by Sonogashira coupling (Section 2.2.9.) display cytostatic activities.

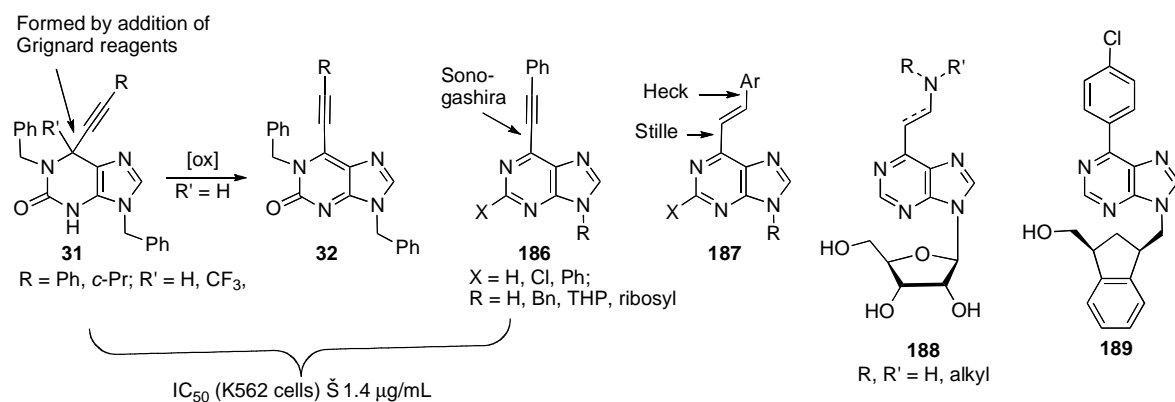

Scheme 41

4.2. Antimicrobial purines

We have found that 6-aryl- or heteroaryl-9-benzylpurines are potent inhibitors of *Mycobacterium tuberculosis in vitro*.^{47h,48e,j,p,q} The structure of some of the most active compounds as well as a SAR

summary is shown in Scheme 42. The 6-aryl groups are introduced by Stille (Section 2.2.4.), Negishi (Section 2.2.5.) or Suzuki-Miyaura coupling (Section 2.2.6.). Our class of potential TB drugs are inactive towards other classes of bacteria as well as several pathogenic protozoa.

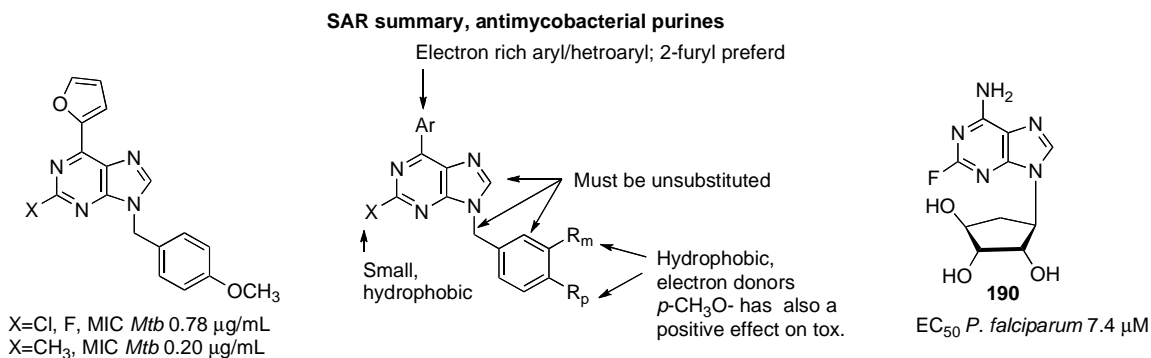

Furthermore, the compounds exhibit no cross-resistance with today's commonly used TB-drugs and the purines are, in contrast to 6-arylpurinenucleosides,^{57a} in general of low toxicity towards mammalian cells. Modified purines have otherwise attracted little attention as potential drugs against pathogenic microorganisms. However, some synthetic carbocyclic nucleosides, available by allylic alkylation as described in Section 3.3., are reported to inhibit growth of pathogenic protozoa; *Plasmodium falciparum* (malaria)^{60a,110z,110jj} and *Leishmania donovani* (visceral leishmaniasis)^{110e,112} by quite selective inhibition of protozoal *S*-adenosyl-L-homocysteine. 2-Fluoronoraristeromycin **109** (Scheme 42) is an example of carbocyclic nucleoside with effect on *P. falciparum*.^{110z}

4.3. Antiviral purines

Natural products like the carbocyclic nucleosides neoplanocin A **21** (see Scheme 3) and aristeromycin **173** (see Scheme 38) manifest potent antiviral activities, but they are far too toxic for clinical use. Hence a number of modified carbocyclic nucleosides have been synthesized and evaluated as antivirals.¹¹³ Pd(0)-catalyzed allylic alkylation has facilitated the synthesis of such compounds and the chemistry is discussed in Section 3.3. The most successful compound is abacavir **183**¹¹⁴ (see Scheme 39), which is a clinically used anti-HIV drug. Compounds **191**,^{79c} **192**,^{44a} **193**,¹¹⁵ and **194**^{92f} (Scheme 43) demonstrate some of the structural diversity among antiviral purines which are not carbocyclic nucleosides and where metal mediated C–C or C–N bond forming reactions have been applied in their synthesis.

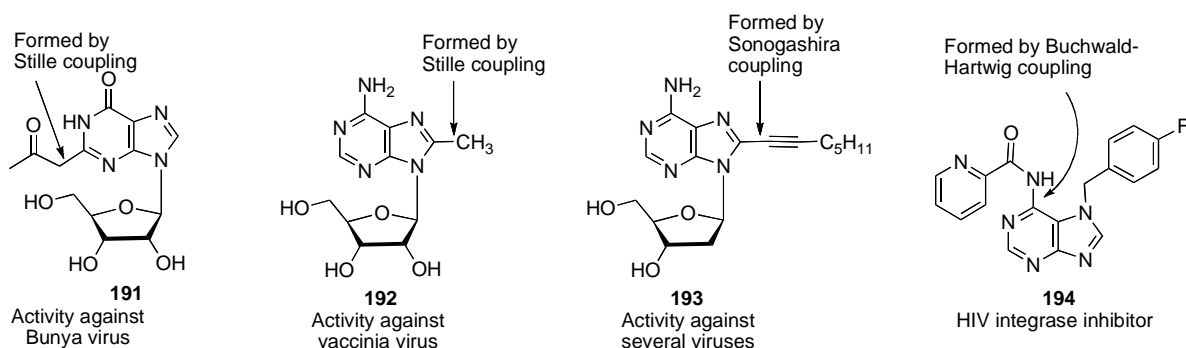

It is worth noting that several 2- or 8-ethynylpurines are potent antivirals, but also highly toxic towards mammalian cells.^{47d,115} Also a 2-ethynyl derivative of the antimycobacterial 6-arylpurines discussed in Section 4.2., displayed high toxicity.^{47h} For a discussion on cytotoxic 6-alkynylpurines, see Section 4.1.

The 2-oxopurine adduct **195** was synthesized by the general route depicted in Scheme 6. Compound **195** may be regarded as a purine analog of the non-nucleoside reverse transcriptase inhibitor Efavirenz **196** (Scheme 44), clinically used anti-HIV drug, but the purine **195** was devoid of antiviral properties.^{27c}

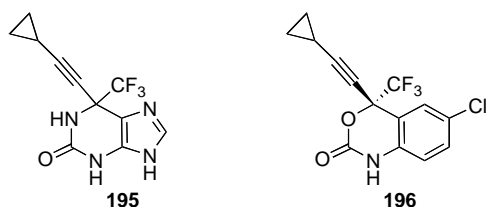

Scheme 44

4.4. Adenosine receptor ligands

Adenosine **4** (Scheme 1) is a signaling substance which mediate its effects by activation of four different G-protein-coupled receptors (A_1 , A_{2A} , A_{2B} and A_3). Selective ligands for one of these receptors may have a drug potential (A_1 antagonists for treatment of asthma, A_{2A} antagonists as anti-Parkinson drugs, A_{2B} antagonists for treatment of chronic pulmonary diseases and A_3 antagonists as anti-inflammatory agents).¹¹⁶ This has led to an extensive investigation of modified purines as selective adenosine receptor ligands. Some examples of quite potent and selective ligands, synthesized by chemistry described herein, are compounds **197**,^{92h} **198**,⁴⁸ⁿ **199**^{63a} and **200**^{68y} (Scheme 45).

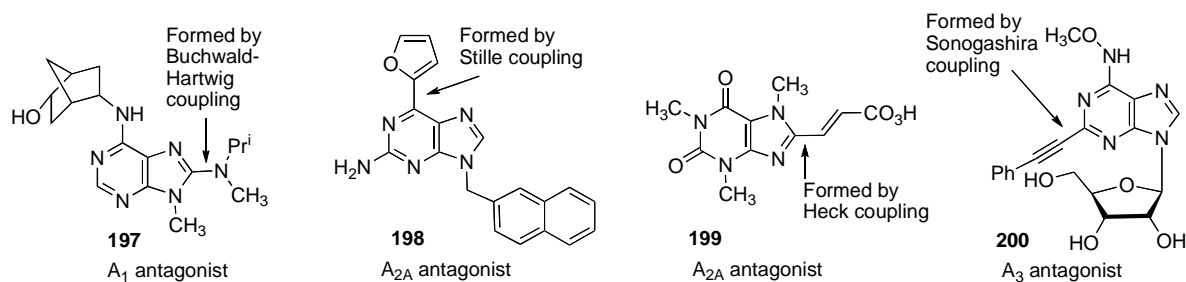

Scheme 45

Compound **201** (Scheme 46), synthesized by a Diels-Alder reaction of a *O*-protected 6-vinylpurine as a key-step (see Section 2.2.12.) displayed, in contrast to the amino analog **202**, no affinity for A_1 receptors.^{48a}

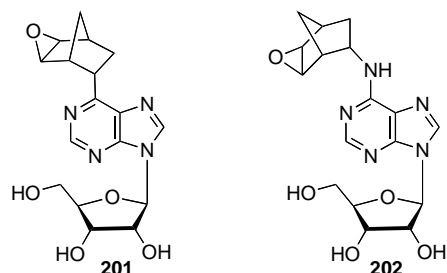

Scheme 46

4.5. Cytokinin analogs

Cytokinins (CKs) are plant growth hormones that promote cell division and cell growth.³ 6-Benzylaminopurine (BAP, **8**) and *trans*-zeatin (*t*-Z, **9**) (Scheme 2) are among the most potent naturally occurring CKs. *trans*-Zeatin is metabolized to inactive adenine by the enzyme system cytokinin oxidase/dehydrogenase. Analogs of BAP and *t*-Z where the NHCH₂ fragment in the side chain is replaced by a two-carbon fragment have been studied as potential CKs with increased enzymatic stability.

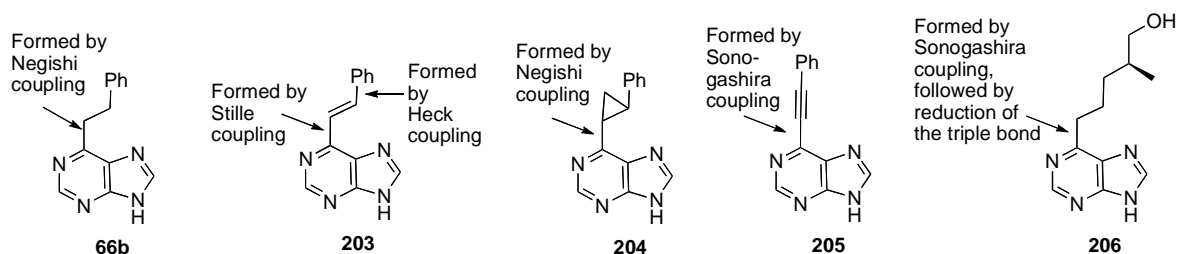

Scheme 47

Compounds **66b**, **203** and **204** displayed CK activity, whereas the alkyne **205** was inactive (Scheme 47).⁵¹¹ Also related *t*-Z analogs with potent CK activity have been synthesized.^{27b,48d,69c} An interesting finding was that the *t*-Z analog **206** was active^{69c} even though it has been believed that unsaturation(s) in the side chain is a requirement for CK action.³

4.6. Inhibitors of 15-lipoxygenase

Reactions involving free radicals are an inherent feature of plant senescence. These reactions contribute to oxidative deterioration that ultimately leads to cell death. Lipase mediated degradation of phospholipids results in release of free fatty acids. The acids may be substrate for lipoxygenases and hence peroxidation and oxidative deterioration is accelerated. Lipoxygenase (LO) has been found in a large number of higher plants, but their physiological role is still disputed. At present, it is generally believed that lipoxygenases play a role in the response of plants to wounding, possibly due to the toxicity of LO metabolites towards invading fungi and bacteria. Other activities of lipoxygenase metabolites have been suggested as well, for instance growth regulation and senescence. Cytokinins (CKs, see also Section 4.5.) mediate antioxidant effects in plants and mammalian cells. *trans*-Zeatin and derivatives inhibit lipoperoxidation in rat kidney homogenates.¹¹⁷ Hence, an investigation of antioxidant properties of purine derivatives originally designed as CK analogs^{27b,48d,551,69c} (Section 4.5.) was undertaken.^{49k,51d,69c} BAP, *t*-Z and synthetic analogs were examined as potential Dipicrylhydrazyl (DPPH) scavengers and as inhibitors of 15-lipoxygenase (15-LO). The natural plant hormones BAP, *t*-Z were essentially inactive in both assays, but several analogs, 6-alkenyl-, 6-cyclopropyl- or 6-alkynylpurines (*i.e.* compounds **203–205**, Scheme 47) have a profound inhibiting effect on 15-lipoxygenase from soybeans. A variety of substituents are tolerated in the purine 2-, 8- and 9-position and also *N*-7 alkylated isomers are active. These compounds were only weak DPPH scavengers and may therefore be regarded as so-called non-antioxidant inhibitors of 15-LO. Compounds with a –CH₂CH₂– fragment attached to C-6 (*i.e.* compound **66b**, Scheme 47) were not 15-LO inhibitors.

5. Conclusions

The introduction of modern metal-mediated C–C and C–N bond forming reactions in purine chemistry has revolutionized synthesis of purine- and purine nucleoside derivatives over the last 20–25 years and allowed easy access to a number of potential drugs and molecular tools. Aryl, alkenyl and alkyl substituents can readily be introduced in the purine 2-, 6- or 8-position by Pd-catalyzed coupling reactions between organometallic reagents and halopurines. C–C Bond formation has to some extent also been carried out *via* metallated purines, but such strategies seldom compete favorably with couplings on halopurines. Traditionally, halopurines have been converted to aminopurines simply by substitution reactions with the required primary- or secondary amine, or ammonia. Also couplings between aminopurines and aryl halides have been performed. The method of choice depends on the availability and reactivity of the coupling partner. The latter factor is not necessarily easy to predict from current knowledge. Aryl substituents may be introduced at ring nitrogens by Cu-mediated reactions with arylboronic acids and a wide range of carbocyclic purine nucleosides have been prepared with Pd(0)-catalyzed allylic alkylation as a key-step. Numerous purines displaying interesting bioactivities like for instance cytotoxic-, antimicrobial- and antiviral activities have been synthesized by the methodologies discussed herein. The same is true also for adenosine receptor ligands, cytokinins and 15-lipoxygenase inhibitors as well as several other classes of bioactive purine derivatives not covered herein. Although not discussed in this chapter, metal mediated C–C or C–N bond formations are also valuable in synthesis of modified DNA and RNA.

Acknowledgments

Financial support from the Norwegian Research Council as well as the University of Oslo to the author's research projects described herein, is highly acknowledged.

References

1. (a) Rosemeyer, H. *Chemistry&Biodiversity* **2004**, *1*, 361, and references therein. (b) Seela, F.; Ramzaeva, N.; Rosemeyer, H. In *Science of Synthesis*; Yamamoto, Y., Ed.; Thieme: Stuttgart, 2004; Vol. 16, p. 1945, and references therein.
2. Fischer, E. *Ber. Dtsch. Chem. Ges.* **1899**, *32*, 2550.
3. Matsubara, S. *Crit. Rev. Plant. Sci.* **1990**, *9*, 17.
4. Lin, Y.-L.; Huang, R.-L.; Chang, C.-M.; Kuo, Y.-H. *J. Nat. Prod.* **1997**, *60*, 982, and references therein.
5. Cherbuliez, E.; Bernhard, K. *Helv. Chim. Acta* **1932**, *15*, 464.
6. (a) Pettit, G. R.; Ode, R. H.; Coomes, R. M.; Ode, S. L. *Lloydia* **1976**, *39*, 363. (b) Fuhrman, F. A.; Fuhrman, G. J.; Mosher, H. S. *Science* **1981**, *212*, 557.
7. Iwagawa, T.; Kaneko, M.; Okamura, H.; Nakatani, M.; van Soest, R. W. M. *J. Nat. Prod.* **1998**, *61*, 1310, and references therein.
8. Kang, H.; Fenical, W. *Tetrahedron Lett.* **1997**, *38*, 941.
9. Rudi, A.; Aknin, M.; Gaydou, E.; Kashman, Y. *J. Nat. Prod.* **2004**, *67*, 1932, and references therein.
10. Scheuer, P. J. *Acc. Chem. Res.* **1977**, *10*, 33, and references therein.
11. Goto, T.; Toya, Y.; Ohgi, T.; Kondo, T. *Tetrahedron Lett.* **1982**, *23*, 1271, and references therein.
12. Terahara, A.; Haneishi, T.; Arai, M.; Hata, T.; Kuwano, H.; Tamura, C. *J. Antibiot.* **1982**, *35*, 1711, and references therein.
13. Seki, J.; Shimada, N.; Takahashi, K.; Takita, T.; Takeuchi, T.; Hoshino, H. *Antimicrobial Agents Chemother.* **1989**, *33*, 773, and references therein.
14. (a) Ichiba, T.; Nakao, Y.; Scheuer, P. J.; Sata, N. U.; Kelly-Borges, M. *Tetrahedron Lett.* **1995**, *36*, 3977. (b) Searle, P. A.; Molinski, T. F. *J. Org. Chem.* **1995**, *60*, 4296.

15. (a) Hayashi, M.; Yaginuma, S.; Yoshioka, H.; Nakatsu, K. *J. Antibiot.* **1981**, *34*, 675. (b) Naba, M.; Nagashima, K.; Tsukagoshi, S.; Sakurai, Y. *Cancer Res.* **1986**, *46*, 1063, and references therein.
16. See for instance: (a) Elion, G. B.; Hitchings, G. H.; Vander-Werff, H. *J. Biol. Chem.* **1951**, *192*, 505. (b) Elion, G. B.; Burgi, E.; Hitchings, G. H. *J. Am. Chem. Soc.* **1952**, *74*, 411. (c) Elgemeie, G. H. *Curr. Pharm. Design* **2003**, *9*, 2627. (d) Coulthard, S. A.; Hogarth, L. A. *Curr. Pharmacogen.* **2004**, *2*, 163.
17. See for instance: (a) Brockman, R. W.; Cheng, Y.-C.; Schabel, F. M., Jr.; Montgomery, J. A. *Cancer Res.* **1980**, *40*, 3610. (b) Nabhan, C.; Gartenhaus, R. B.; Tallman, M. S. *Leukemia Res.* **2004**, *28*, 429. (c) Anderson, V. R.; Perry, C. M. *Drugs* **2007**, *67*, 1633.
18. See for instance: Nathan, H. C.; Bieber, S.; Elion, G. B.; Hitchings, G. H. *Proc. Soc. Exp. Biol. Med.* **1961**, *107*, 796.
19. See for instance: (a) Elion, G. B.; Furman, P. A.; Fyfe, J. A.; De Miranda, P.; Beauchamp, L.; Schaeffer, H. J. *Proc. Natl. Acad. Sci. USA* **1977**, *74*, 5716. (b) Schaeffer, H. J.; Beauchamp, L.; De Miranda, P.; Elion, G. B.; Bauer, D. J.; Collins, P. *Nature* **1978**, *272*, 583. (c) Fyfe, J. A.; Keller, P. M.; Furman, P. A.; Miller, R. L.; Elion, G. B. *J. Biol. Chem.* **1978**, *253*, 8721. (d) Field, H. J.; *Antimicrob. Chemother.* **1983**, *12 (suppl. B)* 129. (e) Gao, H.; Mitra, A. K. *Synthesis* **2000**, 329. (f) Villarreal, E. C. *Prog. Drug Res.* **2003**, *60*, 263.
20. See for instance: (a) Dahlberg, J. E.; Mitsuya, H.; Blam, S. B.; Broder, S.; Aaronson, S. A. *Proc. Nat. Acad. Sci. USA* **1987**, *84*, 2469. (b) Cooney, D. A.; Ahluwalia, G.; Mitsuya, H.; Fridland, A.; Johnson, M.; Hao, Z.; Dalal, M.; Balzarini, J.; Broder, S.; Johns, D. G. *Biochem. Pharmacol.* **1987**, *36*, 1765. (c) Ahluwalia, G.; Cooney, D. A.; Mitsuya, H.; Fridland, A.; Flora, K. P.; Hao, Z.; Dalal, M.; Broder, S.; Johns, D. G. *Biochem. Pharmacol.* **1987**, *36*, 3797. (d) Piacenti, F. *J. Pharmacother.* **2006**, *26*, 1111.
21. Taylor, E. C.; Martin, S. F. *J. Am. Chem. Soc.* **1974**, *96*, 8095.
22. Vorbrüggen, H.; Krolikiewicz, K. *Angew. Chem.* **1976**, *88*, 724.
23. (a) Ikehara, M.; Limn, W.; Fukui, T. *Chem. Pharm. Bull.* **1977**, *25*, 2702. (b) Nair, V.; Richardson, S. G.; Coffman, R. E. *J. Org. Chem.* **1982**, *47*, 4520. (c) McKenzie, T. C.; Epstein, J. W. *J. Org. Chem.* **1982**, *47*, 4881. (d) Nair, V.; Young, D. A. *J. Org. Chem.* **1984**, *49*, 4340. (e) Nair, V.; Chamberlain, S. D. *J. Am. Chem. Soc.* **1985**, *107*, 2183. (f) Nair, V.; Chamberlain, S. D. *J. Org. Chem.* **1985**, *50*, 5069. (g) Desaubry, L.; Bourguignon, J.-J. *Tetrahedron Lett.* **1995**, *36*, 7875. (h) Medebielle, M.; Fujii, S.; Kato, K. *Tetrahedron* **2000**, *56*, 2655.
24. (a) Lakshman, M. *J. Organomet. Chem.* **2002**, *653*, 234. (b) Hocek, M. *Eur. J. Org. Chem.* **2003**, 245.
25. McKenzie, T. C.; Glass, D. *J. Heterocycl. Chem.* **1987**, *24*, 1551.
26. Lettre, H.; Ballweg, H.; Maurer, H.; Rehberger, D. *Naturwissenschaften* **1963**, *50*, 224.
27. (a) Andresen, G.; Gundersen, L.-L.; Rise, F. *Tetrahedron* **1996**, *52*, 12979. (b) Andresen, G.; Eriksen, A. B.; Dalhus, B.; Gundersen, L.-L.; Rise, F. *J. Chem. Soc., Perkin Trans. 1* **2001**, 1662. (c) Andresen, G.; Gundersen, L.-L.; Rise, F. *Arkivoc* **2001**, *x*, 35. (d) Andresen, G.; Gundersen, L.-L.; Nissen-Meyer, J.; Rise, F.; Spilsberg, B. *Bioorg. Med. Chem. Lett.* **2002**, *12*, 567.
28. Andresen, G.; Gundersen, L.-L.; Lundmark, M.; Rise, F.; Sundell, S. *Tetrahedron* **1995**, *51*, 3655.
29. Dvorakova, H.; Dvorak, D.; Holy, A. *Collect. Czech. Chem. Commun.* **1998**, *63*, 2065.
30. (a) Kobayashi, Y.; Yamamoto, K.; Asai, T.; Nakano, M.; Kumadaki, I. *J. Chem. Soc., Perkin Trans. 1* **1980**, 2755. (b) Nair, V.; Buenger, G. S. *J. Am. Chem. Soc.* **1989**, *111*, 8502. (c) Nair, V.; Purdy, D. F.; Sells, T. B. *J. Chem. Soc., Chem. Commun.* **1989**, 878.
31. (a) Hocek, M.; Holy, A. *Collect. Czech. Chem. Commun.* **1999**, *64*, 229. (b) Cesnek, M.; Hocek, M.; Holy, A. *Collect. Czech. Chem. Commun.* **2000**, *65*, 1357. (c) Nunez, M. C.; Pavani, M. G.; Diaz-Gavilan, M.; Rodriguez-Serrano, F.; Gomez-Vidal, J. A.; Marchal, J. A.; Aranega, A.; Gallo, M. A.; Espinosa, A.; Campos, J. M. *Tetrahedron* **2006**, *62*, 11724.
32. Hocek, M.; Holy, A.; Dvorakova, H. *Collect. Czech. Chem. Commun.* **2002**, *67*, 325.
33. Veliz, E. A.; Stephens, O. M.; Beal, P. A. *Org. Lett.* **2001**, *3*, 2969.
34. Ohno, M.; Gao, Z.-G.; Van Rompaey, P.; Tchilibon, S.; Kim, S.-K.; Harris, B. A.; Gross, A. S.; Duong, H. T.; Van Calenbergh, S.; Jacobson, K. *Bioorg. Med. Chem.* **2004**, *12*, 2995.
35. Dvorakova, H.; Dvorak, D.; Holy, A. *Tetrahedron Lett.* **1996**, *37*, 1285.
36. Tobrman, T.; Stepnicka, P.; Cisarova, I.; Dvorak, D. *Eur. J. Org. Chem.* **2008**, 2167.

37. (a) Tamao, K.; Sumitani, K.; Kumada, M. *J. Am. Chem. Soc.* **1972**, *94*, 4374. (b) Corriu, R. J. P.; Masse, J. P. *J. Chem. Soc., Chem. Commun.* **1972**, 144.
38. (a) Bergstrom, D. E.; Reday, P. A. *Tetrahedron Lett.* **1982**, *23*, 4191. (b) Estep, K. G.; Josef, K. A.; Bacon, E. R.; Carabateas, P. M.; Rumney, S.; Pilling, G. M.; Krafte, D. S.; Volberg, W. A.; Dillon, K.; Dugrenier, N.; Briggs, G. M.; Canniff, P. C.; Gorczyca, W. P.; Stankus, G. P.; Ezrin, A. M. *J. Med. Chem.* **1995**, *38*, 2582. (c) Rueping, M.; Ieawsuwan, W. *Synlett* **2007**, 247.
39. Sugimura, H.; Takei, H. *Bull. Chem. Soc. Jpn.* **1985**, *58*, 664.
40. (a) Fürstner, A.; Leitner, A.; Mendez, M.; Krause, H. *J. Am. Chem. Soc.* **2002**, *124*, 13856. (b) Hocek, M.; Dvorakova, H. *J. Org. Chem.* **2003**, *68*, 5773. (c) Hocek, M.; Hockova, D.; Dvorakova, H. *Synthesis* **2004**, 889. (d) Hocek, M.; Pohl, R.; Cisarova, I. *Eur. J. Org. Chem.* **2005**, 3026. (e) Fürstner, A.; Leitner, A.; Seidel, G. *Org. Synth.* **2005**, *81*, 33.
41. (a) Cong-Danh, N.; Beacourt, J.-P.; Pichat, L. *Tetrahedron Lett.* **1979**, 3159. (b) Nagatsugi, F.; Ogata, Y.; Imoto, S.; Sasaki, S. *Heterocycles* **2007**, *73*, 493.
42. See for instance: (a) Mitchell, T. N. In *Metal-catalyzed Cross-coupling Reactions*; De Meijere, A.; Diederich, F., Eds.; Wiley-VCH: Weinheim, 2004; 2nd ed., p. 125. (b) Espinet, P.; Echavarren, A. M. *Angew. Chem. Int. Ed.* **2004**, *43*, 4704.
43. (a) Nair, V.; Turner, G. A.; Chamberlain, S. D. *J. Am. Chem. Soc.* **1987**, *109*, 7223. (b) Nair, V.; Turner, G. A.; Buenger, G. S.; Chamberlain, S. D. *J. Org. Chem.* **1988**, *53*, 3051. (c) Nair, V.; Buenger, G. S. *Synthesis* **1988**, 848. (d) Nair, V.; Lyons, A. G. *Tetrahedron* **1989**, *45*, 3653. (e) Nair, V.; Lyons, A. G. *Tetrahedron* **1990**, *46*, 7677. (f) Nair, V.; Purdy, D. F. *Tetrahedron* **1991**, *47*, 365.
44. (a) Van Aerschot, A. A.; Mamos, P.; Weyns, N. J.; Ikeda, S.; De Clercq, E.; Herdewijn, P. A. *J. Med. Chem.* **1993**, *36*, 2938. (b) Gundersen, L.-L. *Tetrahedron Lett.* **1994**, *35*, 3155. (c) Gundersen, L.-L.; Bakkestuen, A. K.; Aasen, A. J.; Øverås, H.; Rise, F. *Tetrahedron* **1994**, *50*, 9743.
45. (a) Moriarty, R. M.; Epa, W. R.; Awasthi, A. K. *Tetrahedron Lett.* **1990**, *31*, 5877. (b) Mamos, P.; Van Aerschot, A. A.; Weyns, N. J.; Herdewijn, P. A. *Tetrahedron Lett.* **1992**, *33*, 2413.
46. (a) Gundersen, L.-L.; Langli, G.; Rise, F. *Tetrahedron Lett.* **1995**, *36*, 1945. (b) Langli, G.; Gundersen, L.-L.; Rise, F. *Tetrahedron* **1996**, *52*, 5625. (c) Nolsøe, J. M. J.; Gundersen, L.-L.; Rise, F. *Acta Chem. Scand.* **1999**, *53*, 366.
47. (a) Yamamoto, Y.; Seko, T.; Nemoto, H. *J. Org. Chem.* **1989**, *54*, 4734. (b) Liu, F.; Dalhus, B.; Gundersen, L.-L.; Rise, F. *Acta Chem. Scand.* **1999**, *53*, 269. (c) Chiosis, G.; Lucas, B.; Shtil, A.; Huezo, H.; Rosen, N. *Bioorg. Med. Chem.* **2002**, *10*, 3555. (d) Nair, V.; Bera, B.; Kern, E. R. *Nucleosides, Nucleotides, Nucleic Acids* **2003**, *22*, 115. (e) Story, S.; Gupta, M.; Bonsu, E.; Nair, V. *Nucleosides, Nucleotides, Nucleic Acids* **2005**, *24*, 717. (f) Minetti, P.; Tinti, M. O.; Carminati, P.; Castorina, M.; Di Cesare, M. A.; Di Serio, S.; Gallo, G.; Ghirardi, O.; Giorgi, F.; Giorgi, L.; Piersanti, G.; Bartocchini, F.; Tarzia, G. *J. Med. Chem.* **2005**, *48*, 6887. (g) Nair, V.; Uchil, V.; Neamati, N. *Bioorg. Med. Chem. Lett.* **2006**, *16*, 1920. (h) Brændvang, M.; Gundersen, L.-L. *Bioorg. Med. Chem.* **2007**, *15*, 7144.
48. (a) Øverås, A. T.; Gundersen, L.-L.; Rise, F. *Tetrahedron* **1997**, *53*, 1777. (b) Øverås, A. T.; Bakkestuen, A. K.; Gundersen, L.-L.; Rise, F. *Acta Chem. Scand.* **1997**, *51*, 1116. (c) Nagatsugi, F.; Kawasaki, T.; Tanaka, Y.; Maeda, M.; Sasaki, S. *Nucleic Acids Symp. Ser.* **1998**, *39*, 103. (d) Bråthe, A.; Gundersen, L.-L.; Rise, F.; Eriksen, A. B.; Vollnes, A. V.; Wang, L. *Tetrahedron* **1999**, *55*, 211. (e) Bakkestuen, A. K.; Gundersen, L.-L.; Langli, G.; Liu, F.; Nolsøe, J. M. J. *Bioorg. Med. Chem. Lett.* **2000**, *10*, 1207. (f) Hocek, M.; Holy, A.; Votruba, I.; Dvorakova, H. *Collect. Czech. Chem. Commun.* **2001**, *66*, 483. (g) Nagatsugi, F.; Usui, D.; Kawasaki, T.; Maeda, M.; Sasaki, S. *Bioorg. Med. Chem. Lett.* **2001**, *11*, 343. (h) Fujiwara, T.; Kimoto, M.; Sugiyama, H.; Hirao, I.; Yokoyama, S. *Bioorg. Med. Chem. Lett.* **2001**, *11*, 2221. (i) Nagatsugi, F.; Matsuyama, Y.; Maeda, M.; Sasaki, S. *Bioorg. Med. Chem. Lett.* **2002**, *12*, 487. (j) Gundersen, L.-L.; Nissen-Meyer, J.; Spilsberg, B. *J. Med. Chem.* **2002**, *45*, 1383. (k) Havelkova, M.; Dvorak, D.; Hocek, M. *Tetrahedron* **2002**, *58*, 7431. (l) Bråthe, A.; Gundersen, L.-L.; Nissen-Meyer, J.; Rise, F.; Spilsberg, B. *Bioorg. Med. Chem. Lett.* **2003**, *13*, 877. (m) Wang, J.-F.; Zhang, L.-R.; Yang, Z.-J.; Zhang, L.-H. *Bioorg. Med. Chem.* **2004**, *12*, 1425. (n) Kiselgof, E.; Tulshian, D. B.; Arik, L.; Zhang, H.; Fawzi, A. *Bioorg. Med. Chem. Lett.* **2005**, *15*, 2119. (o) Mitsui, T.; Kimoto, M.; Harada, Y.; Yokoyama, S.; Hirao, I. *J. Am. Chem. Soc.* **2005**, *127*, 8652. (p) Bakkestuen, A. K.; Gundersen, L.-L.; Utenova, B. T. *J. Med. Chem.* **2005**, *48*, 2710. (q)

- Brændvang, M.; Gundersen, L.-L. *Bioorg. Med. Chem.* **2005**, *13*, 6360. (r) Capek, P.; Pohl, R.; Hocek, M. *J. Org. Chem.* **2005**, *70*, 8001. (s) Hocek, M.; Silhar, P.; Shih, I.-h.; Mabery, E.; Mackman, R. *Bioorg. Med. Chem. Lett.* **2006**, *16*, 5290. (t) Brændvang, M.; Gundersen, L.-L. *Synthesis* **2006**, 2993. (u) Uchil, V.; Seo, B.; Nair, V. *J. Org. Chem.* **2007**, *72*, 8577.
49. (a) Sessler, J. L.; Wang, B.; Harriman, A. *J. Am. Chem. Soc.* **1993**, *115*, 10418. (b) Sessler, J. L.; Wang, B.; Harriman, A. *J. Am. Chem. Soc.* **1995**, *117*, 704. (c) Ozola, V.; Persson, T.; Gronowitz, S.; Hörnfeldt, A.-B. *J. Heterocycl. Chem.* **1995**, *32*, 863. (d) Tu, C.; Keane, C.; Eaton, B. E. *Nucleosides, Nucleotides* **1995**, *14*, 1631. (e) Manfredini, S.; Baraldi, P. G.; Bazzanini, R.; Marangoni, M.; Simoni, D.; Balzarini, J.; De Clercq, E. *J. Med. Chem.* **1995**, *38*, 199. (f) Bookser, B. C. *Tetrahedron Lett.* **2000**, *41*, 2805. (g) Lang, P.; Magnin, G.; Mathis, G.; Burger, A.; Biellmann, J.-F. *J. Org. Chem.* **2000**, *65*, 7825. (h) Brill, W. K.-D.; Riva-Toniolo, C. *Tetrahedron Lett.* **2001**, *42*, 6515. (i) Lang, P.; Gerez, C.; Tritsch, D.; Fontecave, M.; Biellmann, J.-F.; Burger, A. *Tetrahedron* **2003**, *59*, 7315. (j) Koh, Y.-h.; Landesman, M. B.; Amador, R.; Rong, F.; An, H.; Hong, Z.; Girardet, J.-L. *Nucleosides, Nucleotides, Nucleic Acids* **2004**, *23*, 501. (k) Bråthe, A.; Gundersen, L.-L.; Malterud, K. E.; Rise, F. *Arch. Pharm. Chem. Life Sci.* **2005**, *338*, 159. (l) Randazzo, A.; Esposito, V.; Galeone, A.; Varra, M.; Virgilio, A.; Mayol, L. *Nucleosides, Nucleotides, Nucleic Acids* **2005**, *24*, 539. (m) Bookser, B. C.; Matelich, M. C.; Ollis, K.; Ugarkar, B. G. *J. Med. Chem.* **2005**, *48*, 3389. (n) Kaucher, M. S.; Davis, J. T. *Tetrahedron Lett.* **2006**, *47*, 6381. (o) Kim, B.-T.; Kim, B.-S.; Han, C.-H.; O, K.-J.; Kim, S.-J.; Chun, J.-C.; Lee, J.-H.; Kim, S.-E.; Hwang, K.-J. *Bull. Korean Chem. Soc.* **2006**, *27*, 986. (p) Moreau, C.; Wagner, G. K.; Weber, K.; Guse, A. H.; Potter, B. V. L. *J. Med. Chem.* **2006**, *49*, 5162. (q) Arsenyan, P.; Ikaunieks, M.; Belyakov, S. *Tetrahedron Lett.* **2007**, *48*, 961. (r) Andrei, M.; Bjørnstad, V.; Langli, G.; Rømming, C.; Klaveness, J.; Tasken, K.; Undheim, K. *Org. Biomol. Chem.* **2007**, *5*, 2070. (s) Greco, N. J.; Tor, Y. *Tetrahedron* **2007**, *63*, 3515. (t) Nair, V.; Uchil, V.; Chi, G.; Dams, I.; Cox, A.; Seo, B. *Nucleosides, Nucleotides, Nucleic Acids* **2007**, *26*, 665.
50. See for instance: Negishi, E.-i.; Zeng, X.; Tan, Z.; Qian, M.; Huang, Z. In *Metal-catalyzed Cross-coupling Reactions*; De Meijere, A.; Diederich, F., Eds.; Wiley-VCH: Weinheim, 2004; 2nd ed, p. 815.
51. (a) Prasad, A. S. B.; Stevenson, T. M.; Citineni, J. R.; Nyzam, V.; Knochel, P. *Tetrahedron* **1997**, *53*, 7237. (b) Hocek, M.; Masojidkova, M.; Holy, A. *Collect. Czech. Chem. Commun.* **1997**, *62*, 136. (c) Hassan, A. E. A.; Abou-Elkair, R. A. I.; Montgomery, J. A.; Secrist, J. A., III *Nucleosides, Nucleotides, Nucleic Acids* **2000**, *19*, 1123. (d) Bråthe, A.; Andresen, G.; Gundersen, L.-L.; Malterud, K. E.; Rise, F. *Bioorg. Med. Chem.* **2002**, *10*, 1581. (e) Hocek, M.; Votruba, I.; Dvorakova, H. *Tetrahedron* **2003**, *59*, 607. (f) Hocek, M.; Hockova, D.; Stambasky, J. *Collect. Czech. Chem. Commun.* **2003**, *68*, 837. (g) Silhar, P.; Pohl, R.; Votruba, I.; Hocek, M. *Org. Lett.* **2004**, *6*, 3225. (h) Switzer, C.; Sinha, S.; Kim, P. H.; Heuberger, B. D. *Angew. Chem. Int. Ed.* **2005**, *44*, 1529. (i) Silhar, P.; Pohl, R.; Votruba, I.; Hocek, M. *Org. Biomol. Chem.* **2005**, *3*, 3001. (j) Ogan, M. D.; Kucera, D. J.; Pendri, Y. R.; Rinehart, J. K. *J. Labelled Comp. Radiopharm.* **2005**, *48*, 645. (k) Silamkoti, A. V.; Allan, P. W.; Hassan, A. E. A.; Fowler, A. T.; Sorscher, E. J.; Parker, W. B.; Secrist, J. A., III *Nucleosides, Nucleotides, Nucleic Acids* **2005**, *24*, 881. (l) Bråthe, A.; Gundersen, L.-L.; Rise, F.; Eriksen, A. B. *J. Plant Growth Regul.* **2005**, *24*, 41. (m) Silhar, P.; Pohl, R.; Votruba, I.; Hocek, M. *Collect. Czech. Chem. Commun.* **2005**, *70*, 1669. (n) Hocek, M.; Naus, P.; Pohl, R.; Votruba, I.; Furman, P. A.; Tharnish, P. M.; Otto, M. J. *J. Med. Chem.* **2005**, *48*, 5869. (o) Silhar, P.; Pohl, R.; Votruba, I.; Klepetarova, B.; Hocek, M. *Collect. Czech. Chem. Commun.* **2006**, *71*, 788.
52. (a) Gundersen, L.-L. *Acta Chem. Scand.* **1996**, *50*, 58. (b) Ding, Y.; Girardet, J.-L.; Hong, Z.; Lai, V. C. H.; An, H.; Koh, Y.-h.; Shaw, S. Z.; Zhong, W. *Bioorg. Med. Chem. Lett.* **2005**, *15*, 709. (c) Costanzi, S.; Tikhonova, I. G.; Ohno, M.; Roh, E. J.; Joshi, B. V.; Colson, A.-O.; Houston, D.; Maddileti, S.; Harden, T. K.; Jacobson, K. A. *J. Med. Chem.* **2007**, *50*, 3229.
53. Guthmann, H.; Könemann, M.; Bach, T. *Eur. J. Org. Chem.* **2007**, 632.
54. Havelkova, M.; Hocek, M.; Cesnek, M.; Dvorak, D. *Synlett* **1999**, 1145.
55. See for instance: Miyaura, N. In *Metal-catalyzed Cross-coupling Reactions*; De Meijere, A.; Diederich, F., Eds.; Wiley-VCH: Weinheim, 2004; 2nd ed., p. 41.
56. (a) Lakshman, M. K.; Hilmer, J. H.; Martin, J. Q.; Keeler, J. C.; Dinh, Y. Q. V.; Ngassa, F. N.; Russon, L. M. *J. Am. Chem. Soc.* **2001**, *123*, 7779. (b) Havelkova, M.; Dvorak, D.; Hocek, M. *Synthesis* **2001**, 1704. (c) Ding, S.; Gray, N. S.; Ding, Q.; Schultz, P. G. *Tetrahedron Lett.* **2001**, *42*, 8751. (d) Kim, H.

- O. *Arch. Pharmacol Res.* **2001**, *24*, 508. (e) Brill, W. K.-D.; Riva-Toniolo, C.; Müller, S. *Synlett* **2001**, 1097. (f) Brun, V.; Legraverend, M.; Grierson, D. S. *Tetrahedron* **2002**, *58*, 7911. (g) Raboisson, P.; Lugnier, C.; Muller, C.; Reimund, J.-M.; Schultz, D.; Pinna, G.; Le Bec, A.; Basaran, H.; Desaubry, L.; Gaudiot, F.; Seloum, M.; Bourguignon, J.-J. *Eur. J. Med. Chem.* **2003**, *38*, 199. (h) Wan, Z.; Boehm, J. C.; Bower, M. J.; Kassis, S.; Lee, J. C.; Zhao, B.; Adams, J. L. *Bioorg. Med. Chem. Lett.* **2003**, *13*, 1191. (i) van Tilburg, E. W.; Gremmen, M.; von Frijtag Drabbe Künzel, J.; de Groote, M.; IJzerman, A. P. *Bioorg. Med. Chem.* **2003**, *11*, 2183. (j) Hocek, M.; Pohl, R. *Synthesis* **2004**, 2869. (k) Chang, L. C. W.; Spanjersberg, R. F.; von Frijtag Drabbe Künzel, J. K.; Mulder-Krieger, T.; Brussee, J.; IJzerman, A. P. *J. Med. Chem.* **2006**, *49*, 2861. (l) Vandromme, L.; Piguel, S.; Lozach, O.; Meijer, L.; Legraverend, M.; Grierson, D. S. *Bioorg. Med. Chem. Lett.* **2006**, *16*, 3144. (m) Cerna, I.; Pohl, R.; Klepetarova, B.; Hocek, M. *Org. Lett.* **2006**, *8*, 5389. (n) Capek, P.; Vrabel, M.; Hasnik, Z.; Pohl, R.; Hocek, M. *Synthesis* **2006**, 3515.
57. (a) Hocek, M.; Holy, A.; Votruba, I.; Dvorakova, H. *J. Med. Chem.* **2000**, *43*, 1817. (b) Hocek, M.; Holy, A.; Votruba, I.; Dvorakova, H. *Collect. Czech. Chem. Commun.* **2000**, *65*, 1683. (c) Lakshman, M. K.; Thomson, P. F.; Nuqui, M. A.; Hilmer, J. H.; Sevova, N.; Boggess, B. *Org. Lett.* **2002**, *4*, 1479. (d) Fernandez, F.; Garcia-Mera, X.; Morales, M.; Rodriguez-Borges, J. E.; De Clercq, E. *Synthesis* **2002**, 1084. (e) Berree, F.; Girard-Le Bleis, P.; Carboni, B. *Tetrahedron Lett.* **2002**, *43*, 4935. (f) Yao, S.-W.; Lopes, V. H. C.; Fernandez, F.; Garcia-Mera, X.; Morales, M.; Rodriguez-Borges, J. E.; Cordeiro, M. N. D. S. *Bioorg. Med. Chem.* **2003**, *11*, 4999. (g) Liu, J.; Janeba, Z.; Robins, M. J. *Org. Lett.* **2004**, *6*, 2917. (h) Liu, J.; Robins, M. J. *Org. Lett.* **2004**, *6*, 3421. (i) Fernandez, F.; Garcia-Mera, X.; Morales, M.; Vilarino, L.; Caamano, O.; De Clercq, E. *Tetrahedron* **2004**, *60*, 9245. (j) Liu, J.; Robins, M. J. *Org. Lett.* **2005**, *7*, 1149. (k) Lakshman, M. K.; Gunda, P.; Pradhan, P. *J. Org. Chem.* **2005**, *70*, 10329. (l) Capek, P.; Pohl, R.; Hocek, M. *Org. Biomol. Chem.* **2006**, *4*, 2278. (m) Collier, A.; Wagner, G. K. *Synth. Commun.* **2006**, *36*, 3713. (n) Villemin, D.; Jullien, A.; Bar, N. *Tetrahedron Lett.* **2007**, *48*, 4191.
58. (a) Amann, N.; Wagenknecht, H.-A. *Synlett* **2002**, 687. (b) Gudmundsson, K. S.; Daluge, S. M.; Condreay, L. D.; Johnson, L. C. *Nucleosides, Nucleotides, Nucleic Acids* **2002**, *21*, 891. (c) Western, E. C.; Daft, J. R.; Johnson, E. M., II; Gannett, P. M.; Shaughnessy, K. H. *J. Org. Chem.* **2003**, *68*, 6767. (d) Gannett, P. M.; Heavner, S.; Daft, J. R.; Shaughnessy, K. H.; Epperson, J. D.; Greenbaum, N. L. *Chem. Res. Toxicol.* **2003**, *16*, 1385. (e) Mayer, E.; Valis, L.; Huber, R.; Amann, N.; Wagenknecht, H.-A. *Synthesis* **2003**, 2335. (f) Gubala, V.; Betancourt, J. E.; Rivera, J. M. *Org. Lett.* **2004**, *6*, 4735. (g) Kohyama, N.; Katashima, T.; Yamamoto, Y. *Synthesis* **2004**, 2799. (h) Laufer, S. A.; Domeyer, D. M.; Scior, T. R. F.; Albrecht, W.; Hauser, D. R. J. *J. Med. Chem.* **2005**, *48*, 710. (i) Valis, L.; Wagenknecht, H.-A. *Synlett* **2005**, 2281. (j) Capek, P.; Hocek, M. *Synlett* **2005**, 3005. (k) Western, E. C.; Shaughnessy, K. H. *J. Org. Chem.* **2005**, *70*, 6378. (l) Harvey, R.; Dai, Q.; Ran, C.; Lim, K.; Blair, I.; Penning, T. M. *Polycyclic Aromat. Compd.* **2005**, *25*, 371. (m) McLaughlin, C. K.; Lantero, D. R.; Manderville, R. A. *J. Phys. Chem. A* **2006**, *110*, 6224. (n) Collier, A.; Wagner, G. *Org. Biomol. Chem.* **2006**, *4*, 4526. (o) Sun, K. M.; McLaughlin, C. K.; Lantero, D. R.; Manderville, R. A. *J. Am. Chem. Soc.* **2007**, *129*, 1894. (p) Dai, Q.; Xu, D.; Lim, K.; Harvey, R. G. *J. Org. Chem.* **2007**, *72*, 4856. (q) Capek, P.; Cahova, H.; Pohl, R.; Hocek, M.; Gloeckner, C.; Marx, A. *Chem. Eur. J.* **2007**, *13*, 6196. (r) Vrabel, M.; Pohl, R.; Klepetarova, B.; Votruba, I.; Hocek, M. *Org. Biomol. Chem.* **2007**, *5*, 2849.
59. Hirota, K.; Kitade, Y.; Kanbe, Y.; Maki, Y. *J. Org. Chem.* **1992**, *57*, 5268.
60. (a) Kitade, Y.; Kozaki, A.; Miwa, T.; Nakanishi, M. *Tetrahedron* **2002**, *58*, 1271. (b) Kasibhatla, S. R.; Hong, K.; Biamonte, M. A.; Busch, D. J.; Karjian, P. L.; Sensintaffar, J. L.; Kamal, A.; Lough, R. E.; Brekken, J.; Lundgren, K.; Grecko, R.; Timony, G. A.; Ran, Y.; Mansfield, R.; Fritz, L. C.; Ulm, E.; Burrows, F. J.; Boehm, M. F. *J. Med. Chem.* **2007**, *50*, 2767.
61. See for instance: Bräse, S.; de Meijere, A. In *Metal-catalyzed Cross-coupling Reactions*; De Meijere, A.; Diederich, F., Eds.; Wiley-VCH: Weinheim, 2004; 2nd ed., p. 217.
62. See for instance: Li, J. J.; Gribble, G. W. *Palladium in Heterocyclic Chemistry*; Pergamon: Oxford, 2000.

63. (a) Jacobson, K. A.; Shi, D.; Gallo-Rodriguez, C.; Manning, M. Jr; Müller, C.; Daly, J. W.; Neumeyer, J. L.; Kiriasis, L.; Pflleiderer, W. *J. Med. Chem.* **1993**, *36*, 2639. (b) Zhao, Y.; Baranger, A. M. *J. Am. Chem. Soc.* **2003**, *125*, 2480.
64. Havelkova, M.; Studenovsky, M.; Dvorak, D. *Collect. Czech. Chem. Commun.* **2000**, *65*, 797.
65. Tobrman, T.; Dvorak, D. *Tetrahedron Lett.* **2004**, *45*, 273.
66. (a) Koyama, S.; Kumazawa, Z.; Kashimura, N. *Nucl. Acids, Symp. Ser.* **1982**, *11*, 41. (b) Matsuda, A.; Satoh, K.; Tanaka, H.; Miyasaka, T. *Nucl. Acids, Symp. Ser.* **1983**, *12*, 5. (c) Koyama, S.; Kondo, H.; Kumazawa, Z.; Kashimura, N.; Nishida, R. *Nucl. Acids, Symp. Ser.* **1983**, *12*, 35. (d) Matsuda, A.; Shinozaki, M.; Miyasaka, T.; Machida, H.; Abiru, T. *Chem. Pharm. Bull.* **1985**, *33*, 1766.
67. See for instance: Marsden, J. A.; Haley, M. M. In *Metal-catalyzed Cross-coupling Reactions*; De Meijere, A.; Diederich, F., Eds.; Wiley-VCH: Weinheim, 2004; 2nd ed., p. 317.
68. (a) Korshun, V. A.; Manasova, E. V.; Berlin, Y. A. *Russ. J. Bioorg. Chem.* **1997**, *23*, 300, and references therein. (b) Legraverend, M.; Ludwig, O.; Bisagni, E.; Leclerc, S.; Meijer, L. *Bioorg. Med. Chem. Lett.* **1998**, *8*, 793. (c) Baraldi, P. G.; Cacciari, B.; Pineda de Las Infantas, M. J.; Romagnoli, R.; Spalluto, G.; Volpini, R.; Costanzi, S.; Vittori, S.; Cristalli, G.; Melman, N.; Park, K.-S.; Ji, X.-d.; Jacobson, K. A. *J. Med. Chem.* **1998**, *41*, 3174. (d) Volpini, R.; Camaioni, E.; Costanzi, S.; Vittori, S.; Klotz, K.-N.; Cristalli, G. *Nucleosides, Nucleotides* **1999**, *18*, 2511. (e) Legraverend, M.; Tunnah, P.; Noble, M.; Ducrot, P.; Ludwig, O.; Grierson, D. S.; Leost, M.; Meijer, L.; Endicott, J. *J. Med. Chem.* **2000**, *43*, 1282. (f) Gunji, H.; Vasella, A. *Helv. Chim. Acta* **2000**, *83*, 1331. (g) Harada, H.; Asano, O.; Hoshino, Y.; Yoshikawa, S.; Matsukura, M.; Kabasawa, Y.; Nijima, J.; Kotake, Y.; Watanabe, N.; Kawata, T.; Inoue, T.; Horizoe, T.; Yasuda, N.; Minami, H.; Nagata, K.; Murakami, M.; Nagaoka, J.; Kobayashi, S.; Tanaka, I.; Abe, S. *J. Med. Chem.* **2001**, *44*, 170. (h) Rieger, J. M.; Brown, M. L.; Sullivan, G. W.; Linden, J.; Macdonald, T. L. *J. Med. Chem.* **2001**, *44*, 531. (i) Harada, H.; Asano, O.; Kawata, T.; Inoue, T.; Horizoe, T.; Yasuda, N.; Nagata, K.; Murakami, M.; Nagaoka, J.; Kobayashi, S.; Tanaka, I.; Abe, S. *Bioorg. Med. Chem.* **2001**, *9*, 2709. (j) Zablocki, J.; Palle, V.; Blackburn, B.; Elzein, E.; Nudelman, G.; Gothe, S.; Gao, Z.; Li, Z.; Meyer, S.; Belardinelli, L. *Nucleosides, Nucleotides, Nucleic Acids* **2001**, *20*, 343. (k) Brun, V.; Legraverend, M.; Grierson, D. S. *Tetrahedron Lett.* **2001**, *42*, 8161. (l) Brun, V.; Legraverend, M.; Grierson, D. S. *Tetrahedron Lett.* **2001**, *42*, 8169. (m) van Tilburg, E. W.; von Frijtag Drabbe Kunzel, J.; de Groote, M.; IJzerman, A. P. *J. Med. Chem.* **2002**, *45*, 420. (n) Volpini, R.; Costanzi, S.; Lambertucci, C.; Taffi, S.; Vittori, S.; Klotz, K.-N.; Cristalli, G. *J. Med. Chem.* **2002**, *45*, 3271. (o) Lee, J.; Kim, S. E.; Lee, J. Y.; Kim, S. Y.; Kang, S. U.; Seo, S. H.; Chun, M. W.; Kang, T.; Choi, S. Y.; Kim, H. O. *Bioorg. Med. Chem. Lett.* **2003**, *13*, 1087. (p) Cesnek, M.; Holy, A.; Masojdkova, M. *Collect. Czech. Chem. Commun.* **2003**, *68*, 2201. (q) Mathieu, R.; Baurand, A.; Schmitt, M.; Gachet, C.; Bourguignon, J.-J. *Bioorg. Med. Chem.* **2004**, *12*, 1769. (r) Vittori, S.; Costanzi, S.; Lambertucci, C.; Portino, F. R.; Taffi, S.; Volpini, R.; Klotz, K.-N.; Cristalli, G. *Nucleosides, Nucleotides, Nucleic Acids* **2004**, *23*, 471. (s) Hocek, M.; Stepnicka, P.; Ludvik, J.; Cisarova, I.; Votruba, I.; Reha, D.; Hobza, P. *Chem. Eur. J.* **2004**, *10*, 2058. (t) Volpini, R.; Costanzi, S.; Lambertucci, C.; Vittori, S.; Martini, C.; Trincavelli, M. L.; Klotz, K.-N.; Cristalli, G. *Purinergic Signalling* **2005**, *1*, 173. (u) Vittori, S.; Volpini, R.; Lambertucci, C.; Taffi, S.; Klotz, K. N.; Cristalli, G. *Nucleosides, Nucleotides, Nucleic Acids* **2005**, *24*, 935. (v) Zhu, R.; Frazier, C. R.; Linden, J.; Macdonald, T. L. *Bioorg. Med. Chem. Lett.* **2006**, *16*, 2416. (w) Cosyn, L.; Gao, Z.-G.; Van Rompaey, P.; Lu, C.; Jacobson, K. A.; Van Calenbergh, S. *Bioorg. Med. Chem.* **2006**, *14*, 1403. (x) Cosyn, L.; Palaniappan, K. K.; Kim, S.-K.; Duong, H. T.; Gao, Z.-G.; Jacobson, K. A.; Van Calenbergh, S. *J. Med. Chem.* **2006**, *49*, 7373. (y) Volpini, R.; Dal Ben, D.; Lambertucci, C.; Taffi, S.; Vittori, S.; Klotz, K.-N.; Cristalli, G. *J. Med. Chem.* **2007**, *50*, 1222. (z) Ghatnekar, J.; Hägerlöf, M.; Oredsson, S.; Alm, K.; Elmroth, S. K. C.; Persson, T. *Bioorg. Med. Chem.* **2007**, *15*, 7426.
69. (a) Camaioni, E.; Costanzi, S.; Vittori, S.; Volpini, R.; Klotz, K.-N.; Cristalli, G. *Bioorg. Med. Chem.* **1998**, *6*, 523. (b) Hocek, M.; Votruba, I. *Bioorg. Med. Chem. Lett.* **2002**, *12*, 1055. (c) Berg, T. C.; Gundersen, L.-L.; Eriksen, A. B.; Malterud, K. E. *Eur. J. Org. Chem.* **2005**, 4988. (d) Berg, T. C.; Bakken, V.; Gundersen, L.-L.; Petersen, D. *Tetrahedron* **2006**, *62*, 6121. (e) Inoue, N.; Sugimoto, O.; Tanji, K.-i. *Heterocycles* **2007**, *72*, 665. (f) Kuchar, M.; Hocek, M.; Pohl, R.; Votruba, I.; Shih, I.-h.; Mabery, E.; Mackman, R. *Bioorg. Med. Chem.* **2008**, *16*, 1400.

70. (a) Sessler, J. L.; Wang, R. *Angew. Chem. Int. Ed.* **1998**, *37*, 1726. (b) Sessler, J. L.; Wang, R. *J. Org. Chem.* **1998**, *63*, 4079. (c) Gunji, H.; Vasella, A. *Helv. Chim. Acta* **2000**, *83*, 2975. (d) Gunji, H.; Vasella, A. *Helv. Chim. Acta* **2000**, *83*, 3229. (e) Catalanotti, B.; Galeone, A.; Gomez-Paloma, L.; Mayol, L.; Pepe, A. *Bioorg. Med. Chem. Lett.* **2000**, *10*, 2005. (f) Tierney, M. T.; Grinstaff, M. W. *Org. Lett.* **2000**, *2*, 3413. (g) Sessler, J. L.; Sathiosatham, M.; Brown, C. T.; Rhodes, T. A.; Wiederrecht, G. *J. Am. Chem. Soc.* **2001**, *123*, 3655. (h) Beilstein, A. E.; Grinstaff, M. W. *J. Organomet. Chem.* **2001**, 637-639, 398. (i) Lambertucci, C.; Costanzi, S.; Vittori, S.; Volpini, R.; Cristalli, G. *Nucleosides, Nucleotides, Nucleic Acids* **2001**, *20*, 1153. (j) Volpini, R.; Costanzi, S.; Lambertucci, C.; Vittori, S.; Klotz, K.-N.; Lorenzen, A.; Cristalli, G. *Bioorg. Med. Chem. Lett.* **2001**, *11*, 1931. (k) Bhardwaj, P. K.; Vasella, A. *Helv. Chim. Acta* **2002**, *85*, 699. (l) Crisp, G. T.; Jiang, Y.-L. *Tetrahedron Lett.* **2002**, *43*, 3157. (m) Coutouli-Argyropoulou, E.; Tsitabani, M.; Petrantonakis, G.; Terzis, A.; Raptopoulou, C. *Org. Biomol. Chem.* **2003**, *1*, 1382. (n) Eppacher, S.; Bhardwaj, P. K.; Bernet, B.; Gala, J. L. B.; Knöpfel, T.; Vasella, A. *Helv. Chim. Acta* **2004**, *87*, 2969. (o) Flasche, W.; Cismas, C.; Herrmann, A.; Liebscher, J. *Synthesis* **2004**, 2335. (p) Faraoni, R.; Blanzat, M.; Kubicek, S.; Braun, C.; Schweizer, W. B.; Gramlich, V.; Diederich, F. *Org. Biomol. Chem.* **2004**, *2*, 1962. (q) Okamoto, A.; Kanatani, K.; Ochi, Y.; Saito, Y.; Saito, I. *Tetrahedron Lett.* **2004**, *45*, 6059. (r) Scheidt, H. A.; Flasche, W.; Cismas, C.; Rost, M.; Herrmann, A.; Liebscher, J.; Huster, D. *J. Phys. Chem. B* **2004**, *108*, 16279. (s) Okamoto, A.; Ochi, Y.; Saito, I. *J. Chem. Soc., Chem. Commun.* **2005**, 1128. (t) Abou-Elkhair, R. A. I.; Netzel, T. L. *Nucleosides, Nucleotides, Nucleic Acids* **2005**, *24*, 85. (u) O'Mahony, G.; Ehrman, E.; Grøtli, M. *Tetrahedron Lett.* **2005**, *46*, 6745. (v) Garg, N. K.; Woodrooffe, C. C.; Lacenere, C. J.; Quake, S. R.; Stoltz, B. M. *J. Chem. Soc., Chem. Commun.* **2005**, 4551. (w) Saito, Y.; Hanawa, K.; Motegi, K.; Omoto, K.; Okamoto, A.; Saito, I. *Tetrahedron Lett.* **2005**, *46*, 7605. (x) Ali, H.; Ahmed, N.; Tessier, G.; van Lier, J. E. *Bioorg. Med. Chem. Lett.* **2006**, *16*, 317. (y) Firth, A. G.; Fairlamb, I. J. S.; Darley, K.; Baumann, C. G. *Tetrahedron Lett.* **2006**, *47*, 3529. (z) Reddy, M. R.; Shibata, N.; Kondo, Y.; Nakamura, S.; Toru, T. *Angew. Chem. Int. Ed.* **2006**, *45*, 8163. (aa) Zhang, X.; Bernet, B.; Vasella, A. *Helv. Chim. Acta* **2006**, *89*, 2861. (bb) Zhang, X.; Bernet, B.; Vasella, A. *Helv. Chim. Acta* **2007**, *90*, 792. (cc) Olejniczak, A.; Wojtczak, B.; Lesnikowski, Z. *J. Nucleosides, Nucleotides, Nucleic Acids* **2007**, *26*, 1611. (dd) Saito, Y.; Matsumoto, K.; Bag, S. S.; Ogasawara, S.; Fujimoto, K.; Hanawa, K.; Saito, I. *Tetrahedron* **2008**, *64*, 3578.
71. (a) Tan, K. L.; Bergman, R. G.; Ellman, J. A. *J. Am. Chem. Soc.* **2002**, *124*, 13964. (b) Tan, K. L.; Park, S.; Ellman, J. A.; Bergman, R. G. *J. Org. Chem.* **2004**, *69*, 7329.
72. Cerna, I.; Pohl, R.; Hocek, M. *J. Chem. Soc., Chem. Commun.* **2007**, 4729.
73. Turek, P.; Novak, P.; Pohl, R.; Hocek, M.; Kotora, M. *J. Org. Chem.* **2006**, *71*, 8978, and references therein.
74. (a) Barton, D. H. R.; Hedgecock, C. J. R.; Lederer, E.; Motherwell, W. B. *Tetrahedron Lett.* **1979**, 279. (b) Leonard, N. J.; Bryant, J. D. *J. Org. Chem.* **1979**, *44*, 4612.
75. See for instance: (a) Tanaka, H.; Uchida, Y.; Shinozaki, M.; Hayakawa, H.; Matsuda, A.; Miyasaka, T. *Chem. Pharm. Bull.* **1983**, *31*, 787. (b) Hayakawa, H.; Haraguchi, K.; Tanaka, H.; Miyasaka, T. *Chem. Pharm. Bull.* **1987**, *35*, 72. (c) Hayakawa, H.; Tanaka, H.; Sasaki, K.; Haraguchi, K.; Saitoh, T.; Takai, F.; Miyasaka, T. *J. Heterocyclic Chem.* **1989**, *26*, 189.
76. Cong-Danh, N.; Beacourt, J.-P.; Pichat, L. *Tetrahedron Lett.* **1979**, 2385.
77. Kumamoto, H.; Tanaka, H.; Tsukioka, R.; Ishida, Y.; Nakamura, A.; Kimura, S.; Hayakawa, H.; Kato, K.; Miyasaka, T. *J. Org. Chem.* **1999**, *64*, 7773.
78. (a) Kato, K.; Hayakawa, H.; Tanaka, H.; Kumamoto, H.; Miyasaka, T. *Tetrahedron Lett.* **1995**, *36*, 6507. (b) Kato, K.; Hayakawa, H.; Tanaka, H.; Kumamoto, H.; Shindoh, S.; Shuto, S.; Miyasaka, T. *J. Org. Chem.* **1997**, *62*, 6833.
79. (a) Palle, V. P.; Elzein, E. O.; Gothe, S. A.; Li, Z.; Gao, Z.; Meyer, S.; Blackburn, B.; Zablocki, J. A. *Bioorg. Med. Chem. Lett.* **2002**, *12*, 2935. (b) Elzein, E.; Palle, V.; Wu, Y.; Maa, T.; Zeng, D.; Zablocki, J. *J. Med. Chem.* **2004**, *47*, 4766. (c) Gupta, M.; Nair, V. *Tetrahedron Lett.* **2005**, *46*, 1165. (d) Nicolaou, K. C.; Pratt, B. A.; Arseniyadis, S.; Wartmann, M.; O'Brate, A.; Giannakakou, P. *ChemMedChem* **2006**, *1*, 41.
80. Kim, H. S.; Ohno, M.; Xu, B.; Kim, H. O.; Choi, Y.; Ji, X. D.; Maddileti, S.; Marquez, V. E.; Harden, T. K.; Jacobson, K. A. *J. Med. Chem.* **2003**, *46*, 4974.

81. Stevenson, T. M.; Prasad, A. S. B.; Citineni, J. R.; Knochel, P. *Tetrahedron Lett.* **1996**, *37*, 8375.
82. Tobrman, T.; Dvorak, D. *Org. Lett.* **2003**, *5*, 4289.
83. Tobrman, T.; Dvorak, D. *Org. Lett.* **2006**, *8*, 1291.
84. Klecka, M.; Tobrman, T.; Dvorak, D. *Collect. Czech. Chem. Commun.* **2006**, *71*, 1221.
85. Gundersen, L.-L. *Acta Chem. Scand.* **1996**, *50*, 462.
86. See for instance: Jiang, L.; Buchwald, S. L. In *Metal-catalyzed Cross-coupling Reactions*; De Meijere, A.; Diederich, F., Eds.; Wiley-VCH: Weinheim, 2004; 2nd ed., p. 699.
87. Chida, N.; Suzuki, T.; Tanaka, S.; Yamada, I. *Tetrahedron Lett.* **1999**, *40*, 2573.
88. Suzuki, T.; Tanaka, S.; Yamada, I.; Koashi, Y.; Yamada, K.; Chida, N. *Org. Lett.* **2000**, *2*, 1137.
89. Suzuki, T.; Suzuki, S. T.; Yamada, I.; Koashi, Y.; Yamada, K.; Chida, N. *J. Org. Chem.* **2002**, *67*, 2874.
90. Harwood, E. A.; Sigurdsson, S. T.; Edfeldt, N. B. F.; Reid, B. R.; Hopkins, P. B. *J. Am. Chem. Soc.* **1999**, *121*, 5081.
91. (a) Harwood, E. A.; Hopkins, P. B.; Sigurdsson, S. T. *J. Org. Chem.* **2000**, *65*, 2959. (b) De Riccardis, F.; Johnson, F. *Org. Lett.* **2000**, *2*, 293. (c) Dai, Q.; Ran, C.; Harvey, R. G. *Org. Lett.* **2005**, *7*, 999. (d) Qian, M.; Glaser, R. *J. Am. Chem. Soc.* **2005**, *127*, 880.
92. (a) Barends, J.; van der Linden, J. B.; van Delft, F. L.; Koomen, G.-J. *Nucleosides, Nucleotides* **1999**, *18*, 2121. (b) Lakshman, M. K.; Keeler, J. C.; Hilmer, J. H.; Martin, J. Q. *J. Am. Chem. Soc.* **1999**, *121*, 6090. (c) Gunda, P.; Russon, L. M.; Lakshman, M. K. *Angew. Chem. Int. Ed.* **2004**, *43*, 6372. (d) Stauffer, S. R.; Steinbeiser, M. A. *Tetrahedron Lett.* **2005**, *46*, 2571. (e) Pottabathini, N.; Bae, S.; Pradhan, P.; Hahn, H.-G.; Mah, H.; Lakshman, M. K. *J. Org. Chem.* **2005**, *70*, 7188. (f) Li, X.; Vince, R. *Bioorg. Med. Chem.* **2006**, *14*, 5742. (g) Jin, G.; Wu, C. C. N.; Tawatao, R. I.; Chan, M.; Carson, D. A.; Cottam, H. B. *Bioorg. Med. Chem. Lett.* **2006**, *16*, 4559. (h) Jin, C.; Burgess, J. P.; Rehder, K. S.; Brine, G. A. *Synthesis* **2007**, 219.
93. (a) Bonala, R. R.; Shishkina, I. G.; Johnson, F. *Tetrahedron Lett.* **2000**, *41*, 7281. (b) Wang, Z.; Rizzo, C. J. *Org. Lett.* **2001**, *3*, 565. (c) Schoffers, E.; Olsen, P. D.; Means, J. C. *Org. Lett.* **2001**, *3*, 4221. (d) Meier, C.; Gräsl, S. *Synlett* **2002**, 802. (e) Gillet, L. C. J.; Schärer, O. D. *Org. Lett.* **2002**, *4*, 4205. (f) Johnson, F.; Bonala, R.; Tawde, D.; Torres, M. C.; Iden, C. R. *Chem. Res. Toxicol.* **2002**, *15*, 1489. (g) Lakshman, M. K.; Gunda, P. *Org. Lett.* **2003**, *5*, 39. (h) Lakshman, M. K.; Ngassa, F. N.; Bae, S.; Buchanan, D. G.; Hahn, H.-G.; Mah, H. *J. Org. Chem.* **2003**, *68*, 6020. (i) Chakraborti, D.; Colis, L.; Schneider, R.; Basu, A. K. *Org. Lett.* **2003**, *5*, 2861. (j) Elmquist, C. E.; Stover, J. S.; Wang, Z.; Rizzo, C. J. *J. Am. Chem. Soc.* **2004**, *126*, 11189. (k) Bonala, R.; Torres, M. C.; Iden, C. R.; Johnson, F. *Chem. Res. Toxicol.* **2006**, *19*, 734. (l) Takamura-Enya, T.; Ishikawa, S.; Mochizuki, M.; Wakabayashi, K. *Chem. Res. Toxicol.* **2006**, *19*, 770. (m) Champeil, E.; Pradhan, P.; Lakshman, M. K. *J. Org. Chem.* **2007**, *72*, 5035. (n) Jacobsen, M. I.; Meier, C. *Nucleosides, Nucleotides, Nucleic Acids* **2007**, *26*, 1217. (o) Ran, C.; Dai, Q.; Ruan, Q.; Penning, T. M.; Blair, I. A.; Harvey, R. G. *J. Org. Chem.* **2008**, *73*, 992.
94. (a) Terrazas, M.; Ariza, X.; Farras, J.; Guisado-Yang, J. M.; Vilarrasa, J. *J. Org. Chem.* **2004**, *69*, 5473. (b) Terrazas, M.; Ariza, X.; Vilarrasa, J. *Org. Lett.* **2005**, *7*, 2477. (c) Vandromme, L.; Legraverend, M.; Kreimerman, S.; Lozach, O.; Meijer, L.; Grierson, D. S. *Bioorg. Med. Chem.* **2007**, *15*, 130. (d) Piguel, S.; Legraverend, M. *J. Org. Chem.* **2007**, *72*, 7026.
95. Lagisetty, P.; Russon, L. M.; Lakshman, M. K. *Angew. Chem. Int. Ed.* **2006**, *45*, 3660.
96. (a) De Riccardis, F.; Bonala, R. R.; Johnson, F. *J. Am. Chem. Soc.* **1999**, *121*, 10453. (b) Takamura-Enya, T.; Ishikawa, S.; Mochizuki, M.; Wakabayashi, K. *Tetrahedron Lett.* **2003**, *44*, 5969. (c) Stover, J. S.; Rizzo, C. J. *Org. Lett.* **2004**, *6*, 4985. (d) Bonala, R. R.; Torres, M. C.; Attaluri, S.; Iden, C. R.; Johnson, F. *Chem. Res. Toxicol.* **2005**, *18*, 457. (e) Takamura-Enya, T.; Enomoto, S.; Wakabayashi, K. *J. Org. Chem.* **2006**, *71*, 5599. (f) Ngassa, F. N.; DeKorver, K. A.; Melistas, T. S.; Yeh, E. A.-H.; Lakshman, M. K. *Org. Lett.* **2006**, *8*, 4613.
97. Ran, C.; Dai, Q.; Harvey, R. G. *J. Org. Chem.* **2005**, *70*, 3724.
98. Antilla, J. C.; Baskin, J. M.; Barder, T. E.; Buchwald, S. L. *J. Org. Chem.* **2004**, *69*, 5578.
99. (a) Bakkestuen, A. K.; Gundersen, L.-L. *Tetrahedron Lett.* **2003**, *44*, 3359. (b) Yue, Y.; Zheng, Z.-G.; Wu, B.; Xia, C.-Q.; Yu, X.-Q. *Eur. J. Org. Chem.* **2005**, 5154. (c) Jacobsen, M. F.; Knudsen, M. M.; Gothelf, K. V. *J. Org. Chem.* **2006**, *71*, 9183.

100. Joshi, R. A.; Patil, P. S.; Muthukrishnan, M.; Ramana, C. V.; Gurjar, M. K. *Tetrahedron Lett.* **2004**, *45*, 195.
101. Huang, H.; Liu, H.; Chen, K.; Jiang, H. *J. Comb. Chem.* **2007**, *9*, 197.
102. (a) Strouse, J. J.; Jeselnik, M.; Tapaha, F.; Jonsson, C. B.; Parker, W. B.; Arterburn, J. B. *Tetrahedron Lett.* **2005**, *46*, 5699. (b) Dai, Q.; Ran, C.; Harvey, R. G. *Tetrahedron* **2006**, *26*, 1764.
103. Trost, B. M. *Acc. Chem. Res.* **1980**, *13*, 385.
104. Trost, B. M.; Kuo, G.-H.; Benneche, T. *J. Am. Chem. Soc.* **1988**, *110*, 621.
105. Saville-Stones, E. A.; Lindell, S. D.; Jennings, N. S.; Head, J. C.; Ford, M. J. *J. Chem. Soc., Perkin Trans. 1* **1991**, 2603.
106. Roberts, S. M.; Shoberu, K. A. *J. Chem. Soc., Perkin Trans. 1* **1991**, 2605.
107. Trost, B. M.; Li, L.; Guile, S. D. *J. Am. Chem. Soc.* **1992**, *114*, 8745.
108. Trost, B. M.; Madsen, R.; Guile, S. D. *Tetrahedron Lett.* **1997**, *38*, 1707.
109. (a) Peel, M. R.; Sternbach, D. D.; Johnson, M. R. *J. Org. Chem.* **1991**, *56*, 4990. (b) Gundersen, L.-L.; Benneche, T.; Undheim, K. *Tetrahedron Lett.* **1992**, *33*, 1085. (c) Gundersen, L.-L.; Benneche, T.; Rise, F.; Gogoll, A.; Undheim, K. *Acta Chem. Scand.* **1992**, *46*, 761. (d) MacKeith, R. A.; McCague, R.; Olivo, H. F.; Palmer, C. F.; Roberts, S. M. *J. Chem. Soc., Perkin Trans. 1* **1993**, 313. (e) Merlo, V.; Reece, F. J.; Roberts, S. M.; Gregson, M.; Storer, R. *J. Chem. Soc., Perkin Trans. 1* **1993**, 1717. (f) Jung, M. E.; Rhee, H. *J. Org. Chem.* **1994**, *59*, 4719. (g) Nokami, J.; Matsuura, H.; Nakasima, K.; Shibata, S. *Chem. Lett.* **1994**, 1071. (h) Berranger, T.; Langlois, Y. *Tetrahedron Lett.* **1995**, *36*, 5523. (i) Trost, B. M.; Madsen, R.; Guile, S. G.; Elia, A. E. H. *Angew. Chem. Int. Ed.* **1996**, *35*, 1569. (j) Trost, B. M.; Madsen, R.; Guile, S. D.; Brown, B. *J. Am. Chem. Soc.* **2000**, *122*, 5947. (k) Brown, B.; Hegedus, L. S. *J. Org. Chem.* **2000**, *65*, 1865. (l) Crimmins, M. T.; Zuercher, W. *J. Org. Lett.* **2000**, *2*, 1065. (m) Crimmins, M. T.; King, B. W.; Zuercher, W. J.; Choy, A. L. *J. Org. Chem.* **2000**, *65*, 8499. (n) Roy, B. G.; Jana, P. K.; Achari, B.; Mandal, S. B. *Tetrahedron Lett.* **2007**, *48*, 1563.
110. (a) Ramesh, K.; Wolfe, M. S.; Lee, Y.; Velde, D. V.; Borchardt, R. T. *J. Org. Chem.* **1992**, *57*, 5861. (b) Liotta, F.; Unelius, C. R.; Kozak, J.; Norin, T. *Acta Chem. Scand.* **1992**, *46*, 686. (c) Coe, D. M.; Roberts, S. M.; Storer, R. *J. Chem. Soc., Perkin Trans. 1* **1992**, 2695. (d) Siddiqi, S. M.; Chen, X.; Schneller, S. W. *Nucleosides, Nucleotides* **1993**, *12*, 267. (e) Da Silva, A. D.; Coimbra, E. S.; Fourrey, J.-L.; Machado, A. S.; Robert-Gero, M. *Tetrahedron Lett.* **1993**, *34*, 6745. (f) Hodgson, D. M.; Witherington, J.; Moloney, B. A. *J. Chem. Soc., Perkin Trans. 1* **1994**, 3373. (g) Margolin, A. L.; Borcharding, D. R.; Wolf-Kugel, D.; Margolin, N. *J. Org. Chem.* **1994**, *59*, 7214. (h) Dyatkina, N.; Semizarov, D.; Victorova, L.; Kravetsky, A.; Theil, F.; von Janta-Lipinski, M. *Nucleosides, Nucleotides* **1995**, *14*, 723. (i) Dyatkina, N. B.; Theil, F.; von Janta-Lipinski, M. *Tetrahedron* **1995**, *51*, 761. (j) Akella, L. B.; Vince, R. *Tetrahedron* **1996**, *52*, 2789. (k) Burlina, F.; Favre, A.; Fourrey, J.-L.; Thomas, M. *J. Chem. Soc., Chem. Commun.* **1996**, 1623. (l) Dhanda, A.; Knutsen, L. J. S.; Nielsen, M.-B.; Roberts, S. M.; Varley, D. R. *J. Chem. Soc., Perkin Trans. 1* **1999**, 3469. (m) Rhee, H.; Yoon, D.-O.; Jung, M. E. *Nucleosides, Nucleotides, Nucleic Acids* **2000**, *19*, 619. (n) An, G.-I.; Rhee, H. *Nucleosides, Nucleotides, Nucleic Acids* **2000**, *19*, 1111. (o) Freer, R.; Geen, G. R.; Ramsay, T. W.; Share, A. C.; Slater, G. R.; Smith, N. M. *Tetrahedron* **2000**, *56*, 4589. (p) Kim, W.; Kim, H.; Rhee, H. *Heterocycles* **2000**, *53*, 219. (q) Kitade, Y.; Kozaki, A.; Yatome, C. *Tetrahedron Lett.* **2001**, *42*, 433. (r) Gurjar, M. K.; Maheshwar, K. *J. Org. Chem.* **2001**, *66*, 7552. (s) Ko, O. H.; Hong, J. H. *Tetrahedron Lett.* **2002**, *43*, 6399. (t) Roy, A.; Schneller, S. W. *J. Org. Chem.* **2003**, *68*, 9269. (u) Hong, J. H.; Oh, C.-H.; Cho, J.-H. *Tetrahedron* **2003**, *59*, 6103. (v) Weigl, U.; Heimberger, M.; Pierik, A. J.; Retey, J. *Chem. Eur. J.* **2003**, *9*, 652. (w) Lerner, C.; Siegrist, R.; Schweizer, E.; Diederich, F.; Gramlich, V.; Jakob-Roetne, R.; Zürcher, G.; Borroni, E. *Helv. Chim. Acta* **2003**, *86*, 1045. (x) Hong, J. H.; Ko, O. H. *Bull. Korean Chem. Soc.* **2003**, *24*, 1289. (y) Hong, J. H. *Arch. Pharmacol. Res.* **2003**, *26*, 1109. (z) Kitade, Y.; Kojima, H.; Zulfiquir, F.; Kim, H.-S.; Wataya, Y. *Bioorg. Med. Chem. Lett.* **2003**, *13*, 3963. (aa) Hegedus, L. S.; Cross, J. *J. Org. Chem.* **2004**, *69*, 8492. (bb) Kim, A.; Hong, J. H. *Nucleosides, Nucleotides, Nucleic Acids* **2004**, *23*, 813. (cc) Velcicky, J.; Lanver, A.; Lex, J.; Prokop, A.; Wieder, T.; Schmalz, H.-G. *Chem. Eur. J.* **2004**, *10*, 5087. (dd) Agrofoglio, L. A.; Amblard, F.; Nolan, S. P.; Charamon, S.; Gillaizeau, I.; Zevaco, T. A.; Guenot, P. *Tetrahedron* **2004**, *60*, 8397. (ee) Kim, J. W.; Choi, B. G.; Hong, J. H. *Bull. Korean Chem. Soc.* **2004**, *25*, 1812. (ff) Ko, O. H.; Hong, J. H. *Arch. Pharm.* **2004**, *337*, 579. (gg) Kim, A.; Hong, J. H. *Nucleosides, Nucleotides, Nucleic Acids*

- 2005, 24, 63. (hh) Oh, C. H.; Hong, J. H. *Bull. Korean Chem. Soc.* **2005**, 26, 1520. (ii) Lanver, A.; Schmalz, H.-G. *Eur. J. Org. Chem.* **2005**, 1444. (jj) Kitade, Y.; Ando, T.; Yamaguchi, T.; Hori, A.; Nakanishi, M.; Ueno, Y. *Bioorg. Med. Chem.* **2006**, 14, 5578. (kk) Huang, W.; Miller, M. J.; De Clercq, E.; Balzarini, J. *Org. Biomol. Chem.* **2007**, 5, 1164. (ll) Hong, J. H. *Arch. Pharmacol Res.* **2007**, 30, 131.
111. (a) Trost, B. M.; Shi, Z. *J. Am. Chem. Soc.* **1996**, 118, 3037. (b) Paquette, L. A.; Bibart, R. T.; Seekamp, C. K.; Kahane, A. L. *Org. Lett.* **2001**, 3, 4039. (c) Trost, B. M.; Brown, B. S.; McEachern, E. J.; Kuhn, O. *Chem. Eur. J.* **2003**, 9, 4442. (d) Guppi, S. R.; Zhou, M.; O'Doherty, G. A. *Org. Lett.* **2006**, 8, 293.
112. Hiraoka, O.; Satake, H.; Iguchi, S.; Matsuda, A.; Ueda, T.; Wataya, Y. *Biochem. Biophys. Res. Commun.* **1986**, 134, 1114.
113. For a review, see for instance: Jeong, L. S.; Lee, J. A. *Antivir. Chem. Chemother.* **2004**, 15, 235.
114. Melroy, J.; Nair, V. *Curr. Pharm. Design* **2005**, 11, 3847.
115. Sagi, G.; Ötvös, L.; Ikeda, S.; Andrei, G.; Snoeck, R.; De Clercq, E. *J. Med. Chem.* **1994**, 37, 1307.
116. For a review, see for instance: Baraldi, P. G.; Aghazadeh, M.; Gessi, S.; Borea, P. A. *Chem. Rev.* **2008**, 108, 238.
117. Mérillon, J. M.; Huguet, F.; Fauconneau, B.; Rideau, M. *Phytother. Res.* **1996**, 10, 704.

Abbreviations

ATP	Adenosine 5'-triphosphate
BAP	6-Benzylaminopurine
BINAP	2,2'-Bis(diphenylphosphino)-1,1'-binaphthyl
BMD	Dibenzoylmethido
cAMP	Cyclic adenosine 5'-triphosphate
CK	Cytokinin
coe	cis-Cyclooctene
cod	Cyclooctadiene
Cy	Cyclohexyl
dba	Dibenzylideneacetone
DCE	1,2-Dichloroethane
ddi	Dinanosine
DDQ	Dichlorodicyanoquinone
DMAP	4-Dimethylaminopyridine
DME	Dimethoxyethane
DMEDA	Dimethylethylenediamine
DMF	Dimethylformamide
DMSO	Dimethylsulfoxide
DNA	Deoxyribonucleic acid
DPPH	Dipicrylhydrazyl
dppp	1,3-Bis(diphenylphosphino)propane
EC ₅₀	Concentration required for 50% effect
EWG	Electron withdrawing group
Fur	Furyl
Hermanns catalyst	(<i>trans</i> -Di- μ -acetobis[2-(di- <i>o</i> -tolylphosphino)benzyl]dipalladium(II)),
HIV	Human immunodeficiency virus
HMPA	Hexamethylphosphoramide
IC ₅₀	Concentration required for 50% inhibition
LDA	Lithium diisopropylamide
LHMDS	Lithium hexamethyldisilazide
LO	Lipoxygenase
LTMP	Lithium 2,2,6,6-tetramethylpiperidide
Met	Metal
MIC	Minimum inhibitory concentration

Mtb	<i>Mycobacterium tuberculosis</i>
NADH/NAD ⁺	Nicotinamide adenine dinucleotide
NIS	<i>N</i> -Iodosuccinimide
NMP	<i>N</i> -Methylpyrrolidine
PAH	Polycyclic aromatic hydrocarbons
RNA	Ribonucleic acid
SAR	Structure activity relationships
SEM	(Trimethylsilyl)ethoxymethyl
TB	Tuberculosis
TBAF	Tetrabutylammonium fluoride
TBDMS	<i>tert</i> -Butyldimethylsilyl
TDS	Texyldimethylsilyl
THF	Tetrahydrofuran
THP	Tetrahydropyranyl
TIPS	Triisopropylsilyl
TMS	Trimethylsilyl
Tol	Tolyl
TPPTS	3,3',3''-Phosphinidynetris(benzenesulfonic acid) trisodium salt
Tr	Trityl
<i>t</i> -Z	<i>trans</i> -Zeatin
Xantphos	4,5-Bis(diphenylphosphino)-9,9-dimethylxanthene

INDOLE PHYTOALEXINS FROM BRASSICACEAE: SYNTHESIS AND ANTICANCER ACTIVITY

Peter Kutschy*^a and Roman Mezencev^b

^a*P. J. Šafárik University, Faculty of Science, Institute of Chemical Sciences, Department of Organic Chemistry, Moyzesova 11, SK-041 00 Košice, Slovakia (e-mail: peter.kutschy@upjs.sk)*

^b*Georgia Institute of Technology, College of Science, School of Biology, 315 Ferst Drive, Atlanta, GA 30332, USA*

Abstract. *Cruciferous indole phytoalexins are represented by indole, 1-methoxyindole, oxindole or indoline moiety with a linear side chain or substituent in the indole position 2, or 2 and 3 and/or benzene part of indole moiety, 3-thiazol-2-yl substituent, 2,3-fused or 3-spiro attached heterocycle. Unique structure of these natural products and their presence in our daily food makes investigation of their biological effects warranted. Besides moderate antibacterial and antifungal activity, some of these compounds were reported to exhibit also antiproliferative and cancer chemopreventive effects. While the quantities isolated from cruciferous plants are often insufficient for investigation of their biological properties, synthetic methods have been elaborated to allow for the detail screening of indole phytoalexins. This review provides the comprehensive information on structure and synthesis of cruciferous indole phytoalexins and some of their analogs. Inhibition of carcinogenesis and proliferation of cancer cells by indole phytoalexins is discussed together with their possible molecular mechanisms of action and prospective development of new anticancer drugs.*

Contents

1. Introduction
 2. Structure and synthesis
 - 2.1. Phytoalexins with sulfur-containing side chain or substituent at indole nucleus
 - 2.2. Phytoalexins with a side chain or substituent at indole nucleus not containing sulfur
 - 2.3. 3-(Thiazole-2-yl)indole derived phytoalexins
 - 2.4. 2,3-Fused indole phytoalexins
 - 2.5. Spiroindoline[3,5']- and spiroindoline[2,5']dihydrothiazole type phytoalexins
 3. Anticancer activity
 - 3.1. Cytostatic and cytotoxic effects
 - 3.2. Cancer chemopreventive activity
 - 3.3. Modulation of immune response
 4. Conclusions
- Acknowledgment
References

1. Introduction

Phytoalexins are antimicrobial low molecular weight secondary metabolites, produced by plants after their exposure to biological (attack of phytopathogenic microorganisms), chemical (heavy metals), or

physical (UV radiation) stress.¹ The first three indole-derived sulfur-containing phytoalexins brassinin, 1-methoxybrassinin and cyclobrassinin were reportedly isolated in 1986 by Takasugi and co-workers from *Pseudomonas cichorii* inoculated Chinese cabbage.^{2a} During the past two decades about forty phytoalexins have been isolated from the plant family *Brassicaceae* (syn. *Cruciferae*), including economically important oilseeds, vegetables and condiments, such as oilseed rape, cabbage, radish, mustard and many others. Cruciferous plants are grown all around the world and constitute the significant part of our daily food. By now, cruciferous indole phytoalexins have been reviewed with regard to their isolation,³ antimicrobial activity, occurrence,⁴ antiproliferative and cancer chemopreventive activity,⁵ synthesis, biosynthesis, biotransformation and their role in plant protection.⁶⁻⁹ However, these natural products have not yet been classified based on their chemical structure, synthetic methods and anticancer activity. Indole phytoalexins isolated from plant family *Brassicaceae* could be prospective natural leads for new biologically active compounds. However, due to their low concentrations in plant materials and tedious methods of their isolation and purification, synthesis of indole phytoalexins and their analogs is critically important for future studies of their biological properties.^{10b}

2. Structure and synthesis

Vast majority of cruciferous phytoalexins has unique indole-derived structure that includes the sulfur atom in a side chain, substituent, or attached five or six-membered heterocyclic ring. Structurally, these natural products can be classified into five groups: (i) Phytoalexins with sulfur-containing side chain or substituent at the indole nucleus; (ii) Phytoalexins with a side chain or substituent at the indole nucleus not containing sulfur; (iii) 3-(Thiazole-2-yl)indole derived phytoalexins; (iv) 2,3-Fused indole phytoalexins, and (v) Spiroindoline[3,5']- and spiroindoline[2,5']dihydrothiazole type phytoalexins.

2.1. Phytoalexins with sulfur-containing side chain or substituent at indole nucleus

Within the group of compounds with a sulfur-containing side chain or substituent at indole nucleus (**1**–**12**, Figure 1), brassinin (**1a**), 1-methoxybrassinin (**1b**) isolated from Chinese cabbage² and brassitin (**1c**) from Japanese radish¹¹ possess the methyl dithiocarbamate (**1a** and **1b**) or thiocarbamate group (**1c**). Compounds **1d** and **1e**, from Chinese cabbage^{2b} and *Brassica oleracea*¹² are their congeners, whereas compounds **2a** and **2b** isolated from *Brassica oleracea*,¹³ as well as **3** and **4** from wasabi¹⁴ are characterized by the presence of the C=N double bond in their side chain, derivable by methylation of corresponding methyl dithiocarbamate functionality. Wasalexin A (**3**), wasalexin B (**4**) and dithiocarbamate side chain- containing dioxibrassinin (**5**) from *Brassica oleracea*¹⁵ possess in their structures oxindole moiety. Interestingly, compounds **3** and **4** differ only in their geometric isomerism. Brussalexin A (**6**) found in Brussels sprouts¹⁶ is besides the compounds **1c** and **1d** the third monothiocarbamate phytoalexin; however the only one of all phytoalexins with sulfur atom attached to indole *via* methylene group. Although brussalexin B has not been described to date, further phytoalexins from Brussels sprouts are expected to be described soon.¹⁶ Phytoalexins **7** isolated from cauliflower,¹⁷ **8** and **9** from Chinese cabbage¹⁸ and **10** from cabbage¹⁵ are derivatives of indole-3-carboxaldehyde. Interestingly, brassicanal B (**9**) was found to be present in equilibrium of opened side chain and cyclic form.¹⁸ Unique structures of rapalexin A (**11a**) and B (**11b**) isolated from *Brassica rapa*¹⁹ represent the first known natural aromatic isothiocyanates. Finally the brassicanate A (**12**), isolated from rutabaga²⁰ is a derivative of methyl indole-3-carboxylate. Two phytoalexins

of this group (**5** and **10**) are chiral. While absolute configuration of (–)-brassicinal C (**10**) remains unknown, the absolute stereochemistry of (*S*)-(–)-dioxibrassinin (**5**) has recently been determined comparing calculated theoretical and experimental VCD (Vibrational Circular Dichroism) spectra of natural (–)-isomer obtained by chiral HPLC.²¹

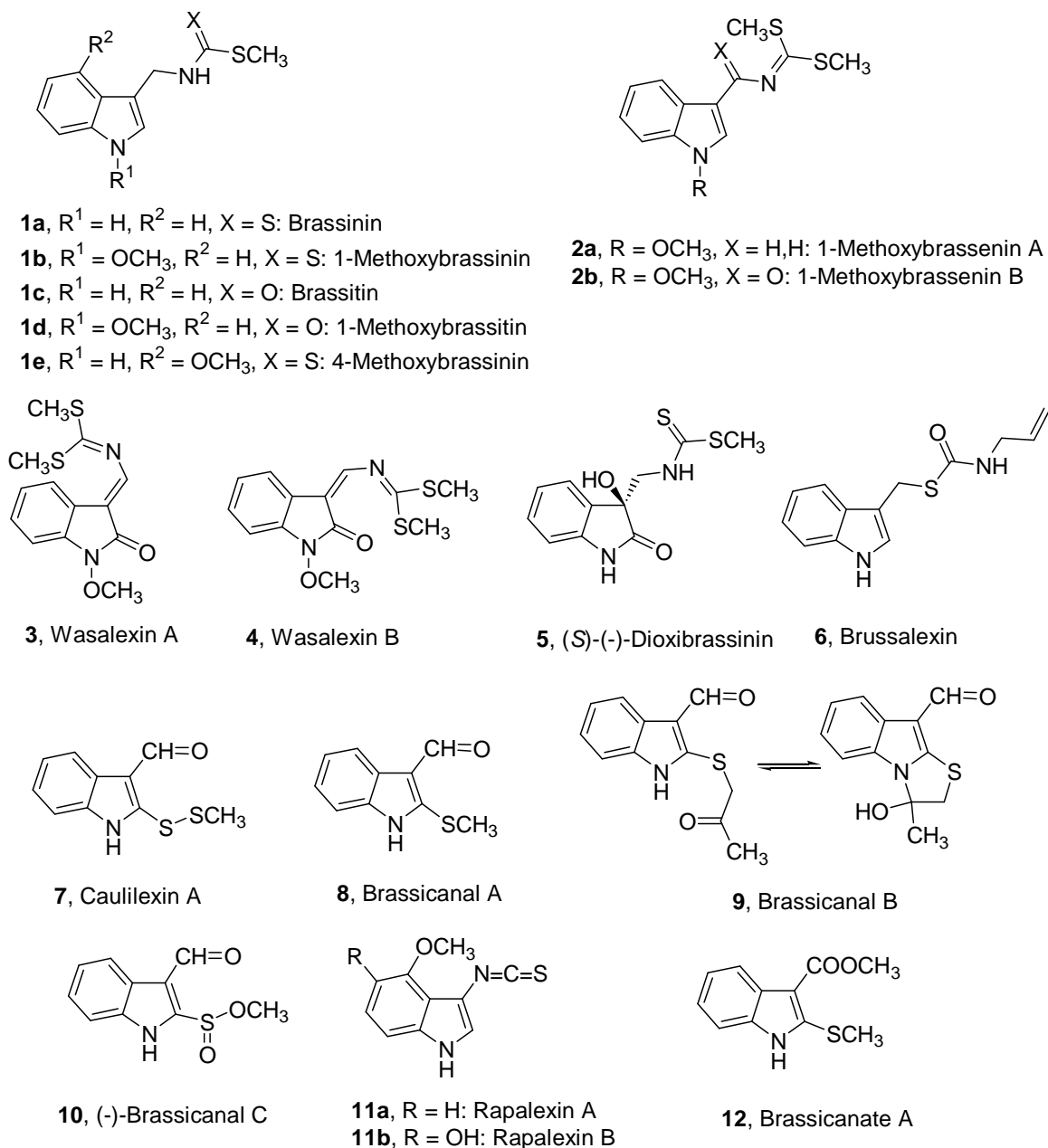
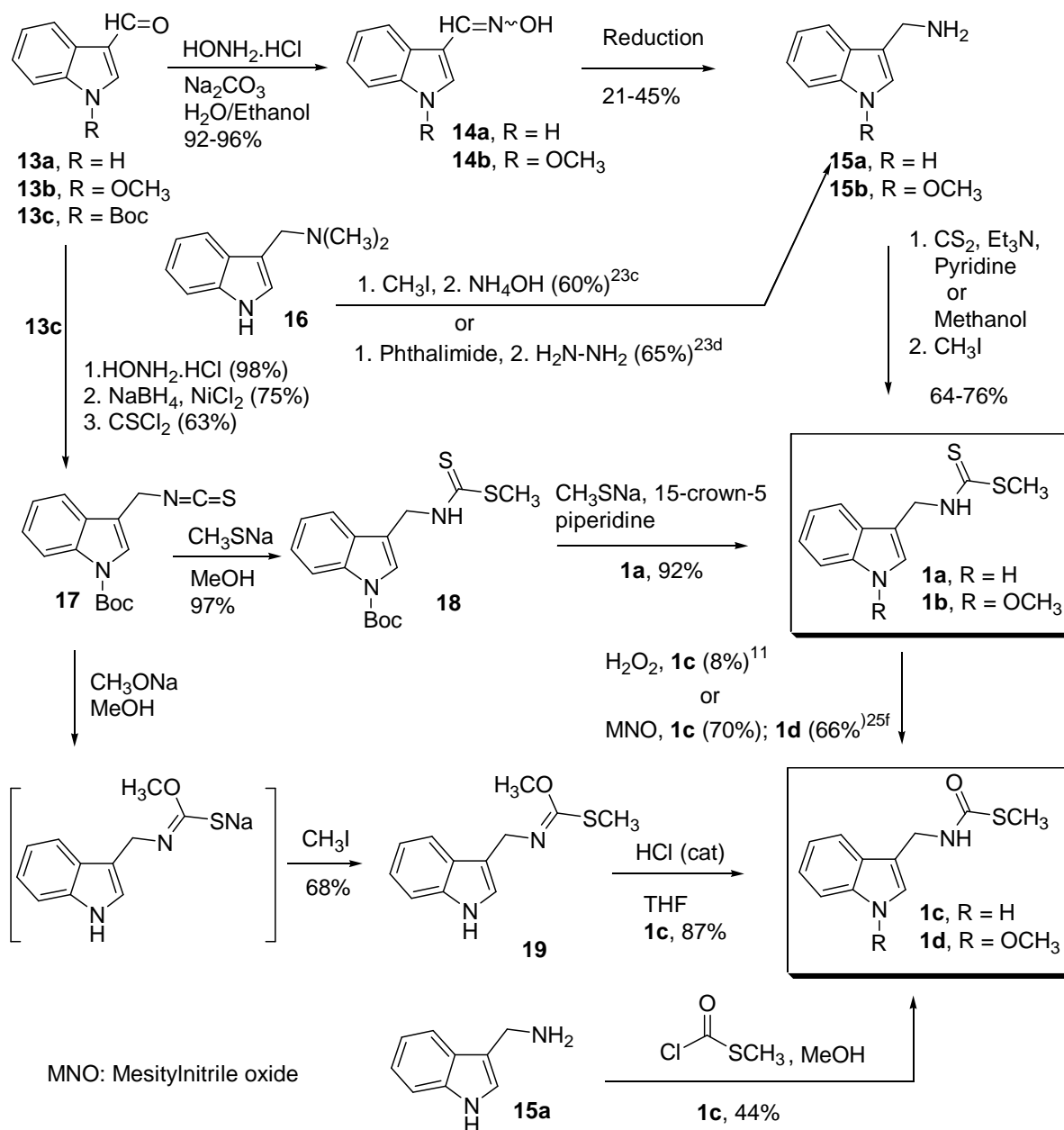

Figure 1

Synthesis of brassinin (**1a**) has been among the most frequently investigated syntheses of cruciferous phytoalexins. Majority of reported syntheses start from indole-3-carboxaldehyde (**13a**), employing the reaction of (1*H*-indole-3-yl)methylamine (**15a**) as the key intermediate, with CS₂ and CH₃I in basic medium² (Scheme 1). Amine **15a** was obtained either by reduction of corresponding oxime (**14a**) or suitable transformation of gramine (**16**). Using the oxime **14a** readily available from indole-3-carboxaldehyde (**13a**) by standard procedure in 96% yield,²² various reduction systems have been developed. Thus reduction with

Dewarda's alloy was described to afford amine **15a** in 99% yield, calculated from UV spectra.^{23a} Isolated yield however did not exceed 40–45%.^{10b}



Scheme 1

Reduction with NaBH₄, catalyzed by nickel boride, *in situ* generated from NiCl₂ and NaBH₄, afforded amine **15a** in 45% yield.¹⁰ In another procedure, oxime was reduced in methanol by hydrogen on Raney nickel catalyst, and the amine formed was not isolated but immediately treated with carbon disulfide and iodomethane to afford brassinin (**1a**) in 72% overall yield.^{23b} Amine **15a** was also obtained from gramine (**16**) in 60% yield by its quarternization and subsequent treatment with ammonium hydroxide^{23c} or in 65% yield by transformation to phthalimido derivative and its subsequent hydrazinolysis.^{23d} A biomimetic approach to brassinin (**1a**) was achieved *via* [1-(*tert*-butoxycarbonyl)indole-3-yl]methyl isothiocyanate (**17**),¹⁰ the only described derivative of indole-3-ylmethyl isothiocyanate, which is supposedly an unstable

biosynthetic intermediate of brassinin.²⁴ Treatment of isothiocyanate **17** with sodium thiomethoxide, followed by deprotection under specific conditions, afforded brassinin (**1a**) in a high yield¹⁰ (Scheme 1). 4-Methoxybrassinin (**1e**) was synthesized from 4-methoxygramine which, after quarternization and treatment with ammonium hydroxide, afforded 4-methoxy-(1*H*-indole-3-yl)methylamine (74%). Its reaction with CS₂ and CH₃I in basic medium resulted in the formation of **1e** in 64% yield.^{23c} 1-Methoxybrassinin (**1b**) was prepared analogously to brassinin (**1a**). Starting 1-methoxyindole-3-carboxaldehyde (**13b**)^{25a} can be advantageously obtained by Vilsmeier formylation of 1-methoxyindole prepared from indoline by the Somei's tungstate method.^{25b} Reduction of oxime **14b**^{25c} to unstable amine **15b** by LiAlH₄ or NiCl₂-NaBH₄ resulted in reductive removal of 1-methoxy group with the formation of (1*H*-indole-3-yl)methylamine (**15a**).^{25d} Reduction with NaBH₄ in the presence of methanesulfonyl chloride afforded 21% yield of amine **15b** which was transformed in 64% yield to 1-methoxybrassinin (**1b**) by treatment with carbon disulfide and iodomethane.^{25d} Significant improvement was achieved by using TiCl₃-NaBH₃CN reduction system. The crude amine after treatment with CS₂ and CH₃I in basic medium afforded **1b** in 60% yield from oxime **15b**.^{25e} Simple replacement of basic solvent by methanol improved overall yield to 76% and shortened the reaction time from 24 h to 15 min.^{25f} To avoid the reduction of oxime **14b**, the amine **15b** was also prepared from 1-unsubstituted amine **15a** which was trifluoroacetylated at primary amino group by ethyl trifluoroacetate (91%) and then reduced to indoline by Et₃SiH (82%). Subsequent tungstate oxidation, methylation and deprotection afforded 75% yield of 1-methoxyamine **15b** which after treatment with CS₂ and CH₃I in basic medium afforded 1-methoxybrassinin (**1b**).^{25g} Brassitin (**1c**) was obtained in 8% yield by direct oxidation of brassinin (**1a**) with hydrogen peroxide¹¹ or recently by acylation of (1*H*-indole-3-yl)methylamine (**15a**) with methyl chlorothioformate²⁶ (Scheme 1). Another approach to brassitin (**1c**) in 87% yield is based on selective acid-catalyzed hydrolysis of compound **19**, preserving the methylthio and hydrolyzing the methoxy group (Scheme 1). Intermediate **19** was synthesized in a one pot reaction from isothiocyanate **17**, using sodium methoxide in methanol not only as a nucleophile, but also as a deprotecting agent and as a base, needed for methylation.^{10b} A convenient method for transformation of thiocarbonyl group in **1a** and **1b** to carbonyl group by mesitylnitrile oxide (MNO) smoothly afforded brassitin (**1c**) and 1-methoxybrassinin (**1d**) in 70 and 66% yield^{25f} (Scheme 1).

Phytoalexins **2a**, **2b**, **3** and **4** characterized by the presence of the C=N double bond in their side chain can be obtained by alkylation of corresponding dithiocarbamate or coupling with suitable reagent already containing dimethyl carbonimidodithioate grouping. 1-Methoxybrassinin A (**2a**) was prepared by simple methylation of **1a** with iodomethane in methanol in the presence of K₂CO₃ (99% yield),¹³ or in acetonitrile using lithium hydride as a base in 78% yield^{25f} (Scheme 2). 1-Methoxyindole-3-carboxylic acid (**20**) obtained from aldehyde **13b** by oxidation with NaClO₂ in 84% yield^{27a} was used as starting compound for the synthesis of 1-methoxybrassinin B (**2b**). Acid **20** was converted by treatment with PCl₃ to an unstable acid chloride **21**, which after reaction with KSCN afforded 1-methoxyindole-3-ylcarbonyl isothiocyanate (**22**). Reaction of isothiocyanate **22** with NaSH and methyl iodide resulted in the formation of thioester **23** (25% yield from acid **20**) as a side product and desired dithiocarbamate **24** (23% yield from acid **20**). Methylation of **24** afforded 1-methoxybrassinin B (**2b**, 81%). Direct introduction of C=N double bond by coupling of acid chloride **21** with dimethyl carbonimidodithioate hydroiodide [HI.HN=C(SCH₃)₂] afforded **2b** in 47% overall yield^{27b} (Scheme 2). Wassalexins A (**3**) and B (**4**) were synthesized from 1-methoxyindole (**25**) which was transformed to 1-methoxyoxindole (**26**) in two steps (Scheme 3) in 60% yield.^{28a} Subsequent

formylation and treatment of resulting enol **27** with thionyl chloride afforded 3-chloromethyleneoxindole (**28**).

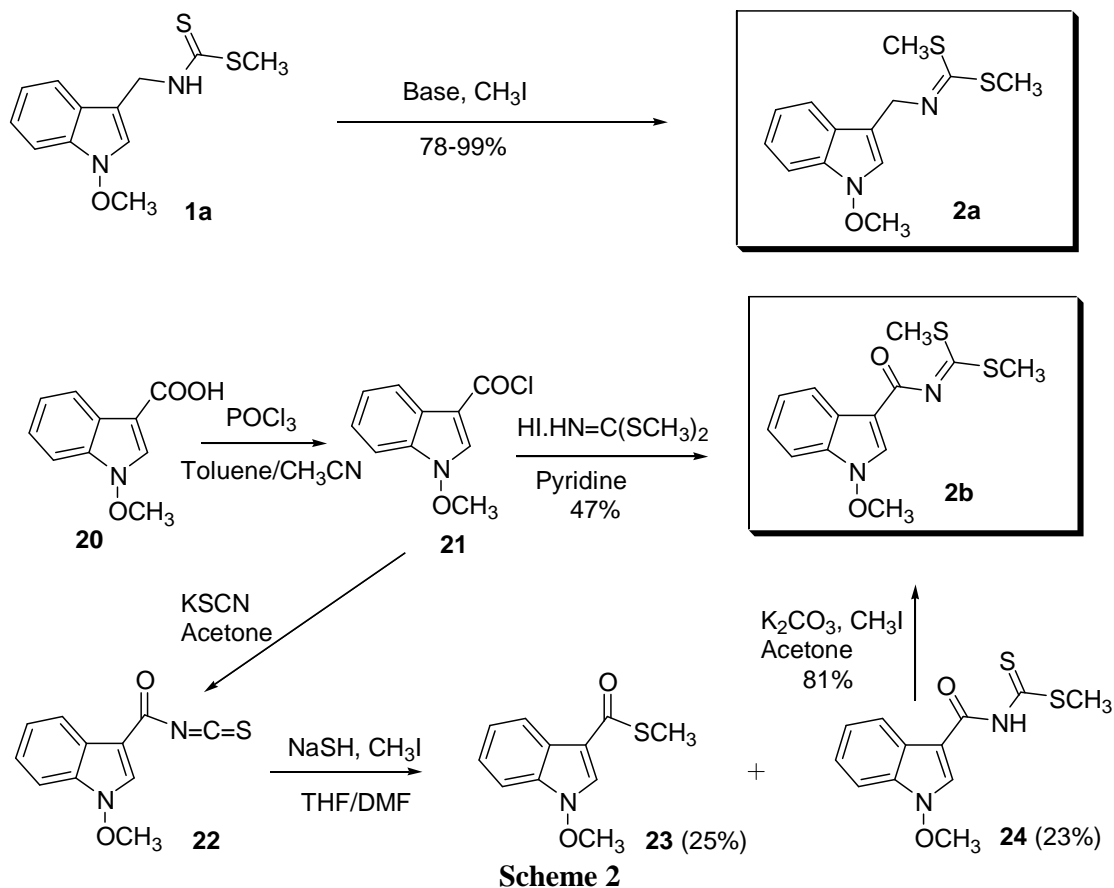

Scheme 2

Transformation to corresponding enamine (**29**), and its treatment with carbon disulfide and iodomethane in the presence of sodium hydride resulted in the synthesis of a mixture of *E/Z* isomeric phytoalexins **3** and **4** in the ratio 2:1, separated by reversed-phase TLC¹⁴ (Scheme 3). Enamine **29** was also prepared by the more effective method *via* Vilsmeier formylation of 1-methoxyoxindole and a new ammonia workup in 86% yield.^{28b}

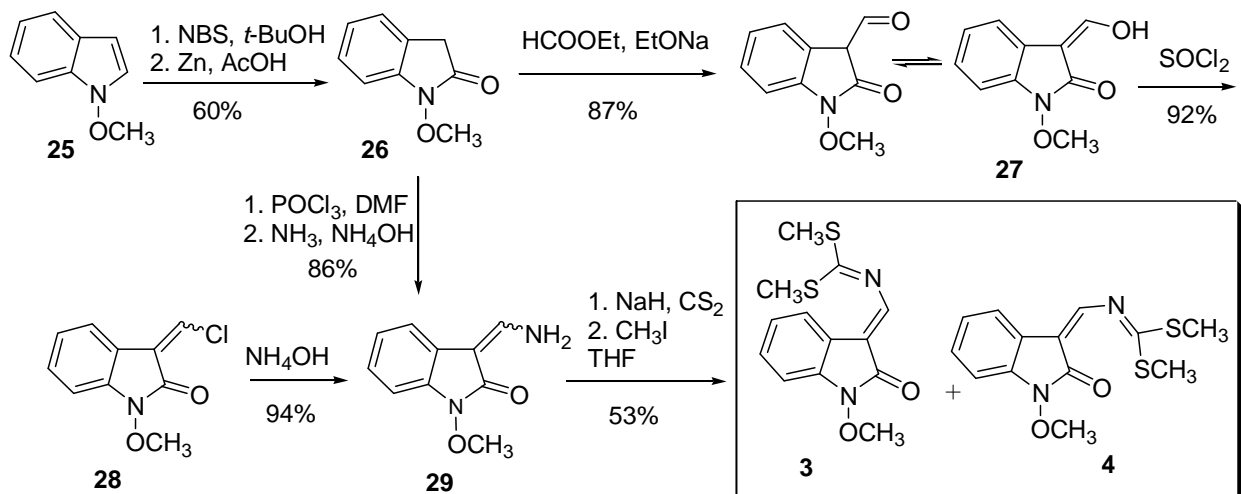

Scheme 3

The third of the oxindole sulfur-containing phytoalexins dioxibrassinin (**5**), was prepared from isatin (**30**) after its transformation to nitro derivative **31** which was reduced by hydrogen to amine **32** on Adams catalyst^{29a} or Pd/C.^{29b} Treatment of **32** with carbon disulfide and iodomethane in basic medium afforded phytoalexin **5**¹⁵ (Scheme 4).

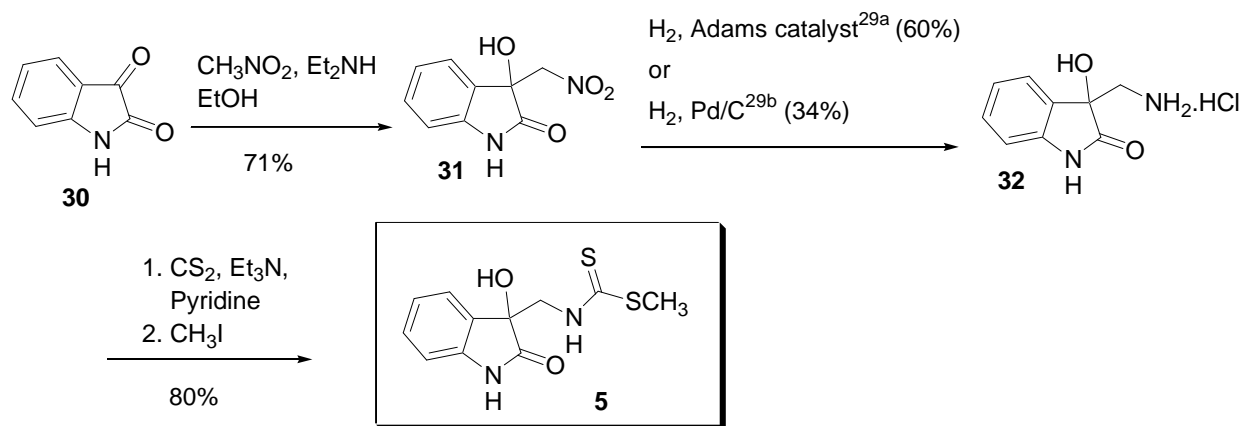

Scheme 4

Synthesis of brussalexin (**6**) started by hydrolysis of Boc-protected indolyl-3-methylthioacetate (**34**) to Boc-protected thiol **35**, which after coupling with allyl isocyanate afforded 1-Boc-brussalexin (**36**). The direct hydrolysis of indolyl-3-methylthioacetate (**33**) was unsuccessful. Subsequent two-step deprotection *via* corresponding *N*-carboxylic acid resulted in the preparation of brussalexin (**6**) in 73% overall yield (Scheme 5).¹⁶

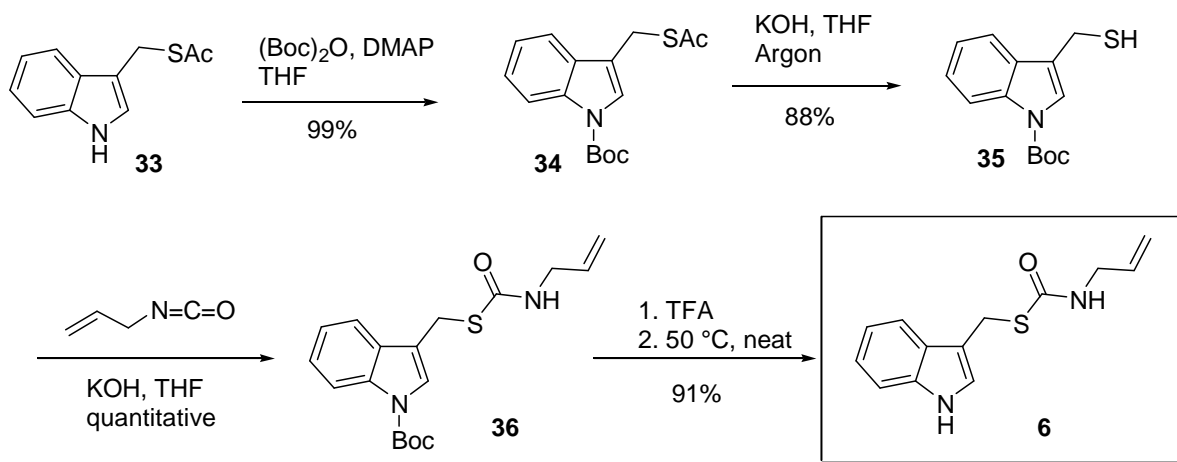

Scheme 5

Syntheses of indole-3-carboxaldehyde phytoalexins **7–10** require the introduction of sulfur-containing substituent into position 2 and formyl group into position 3 of indole nucleus. A suitable starting compound is the indoline-2-thione (**37**) which can be advantageously prepared by treatment of oxindole with P_2S_5 in THF.^{30a,28b} Starting compound **37** can be either formylated in position 3 or derivatized on sulfur and then 3-formylated. *S*-Methylation to 2-methylthioindole (**39**)^{30b} and subsequent formylation,¹⁸ or formylation followed by *S*-methylation^{30c} afforded brassicanal A (**8**, Scheme 6, yields not given). Brassicanal B (**9**) was

prepared in 33% yield by bromoacetone alkylation and subsequent formylation of **37**, whereas racemic brassicanal C (±)-**10** resulted from iodine oxidation of aldehyde **38** in the presence of methanol.¹⁷ Analogous oxidation in the presence of sodium thiomethoxide afforded caulilexin A (**7**) in 33% yield¹⁷ (Scheme 6).

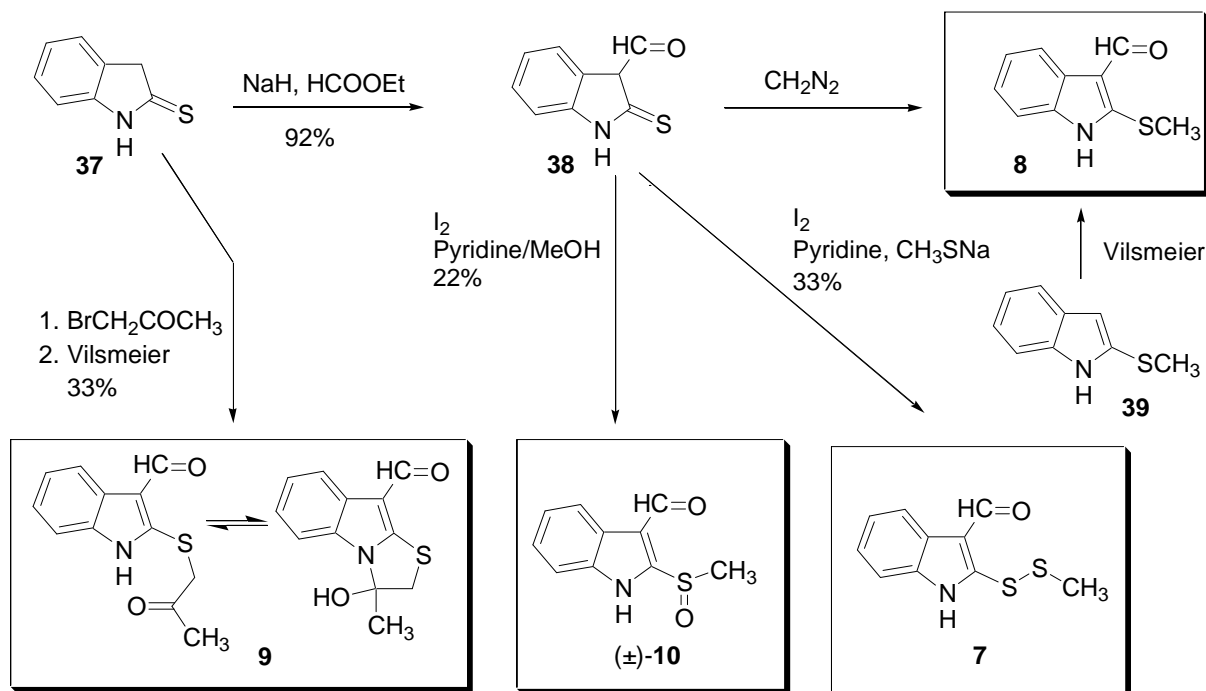

Scheme 6

(Indole-3-yl)isothiocyanate type phytoalexins **11a** and **11b** have been prepared by standard treatment of corresponding amines with thiophosgene.¹⁹ However the preparation of amines had to be designed first, what was done by using indoles **40**^{31a} and **42**^{31b} as starting compounds (Scheme 7).

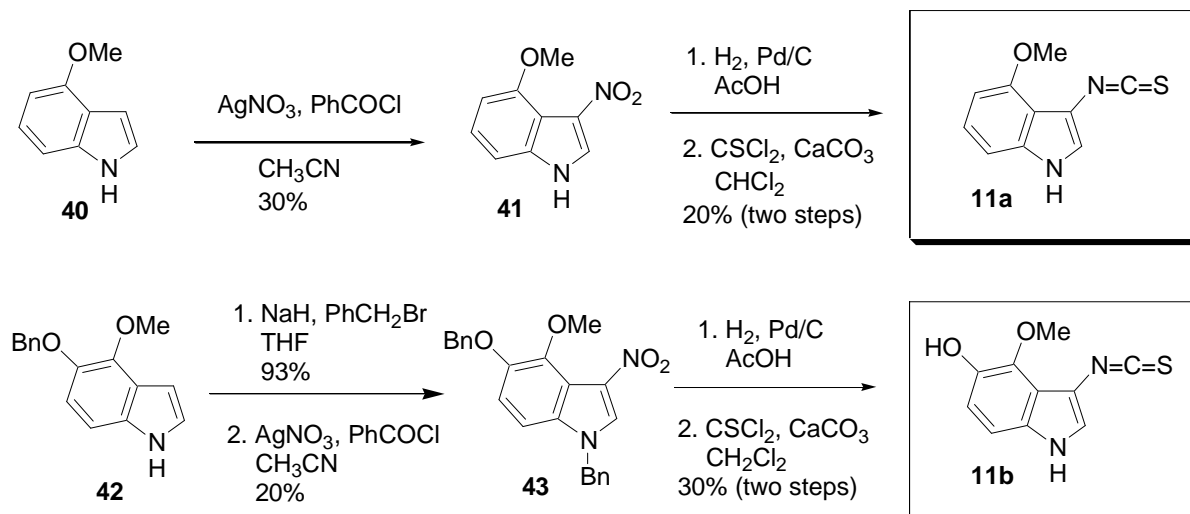

Scheme 7

1-Boc-2-chloroindole-3-carboxaldehyde (**44**) was found to be a suitable starting material for the synthesis of brassicanal A (**12**)²⁰ (Scheme 8). The key synthetic step was the nucleophilic replacement of activated chlorine atom in the intermediate **46** by sodium hydrogen sulfide.

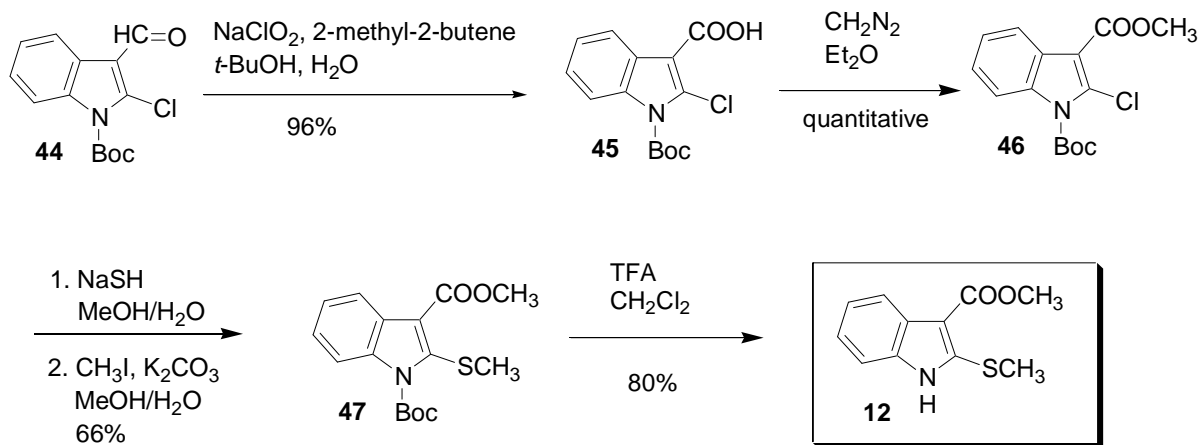

Scheme 8

2.2. Phytoalexins with a side chain or substituent at indole nucleus not containing sulfur

Substances that do not contain sulfur atom in a side chain or substituent at indole moiety (**48–51**) are shown at Figure 2. Within this group of cruciferous phytoalexins, the ester **48** was isolated from wassabi,^{32a} *N*-formyl(indole-3-ylmethyl)amine (**49**, caulilexin B) from cauliflower,¹⁷ indolyl-3-acetonitrile (**50a**) from brown mustard,^{32b} whereas its derivatives **50b** from cauliflower¹⁷ and **50c** from stinkweed.^{32c} 4-Methoxyisatin (**51**, isalexin) was obtained from rutabaga.²⁰

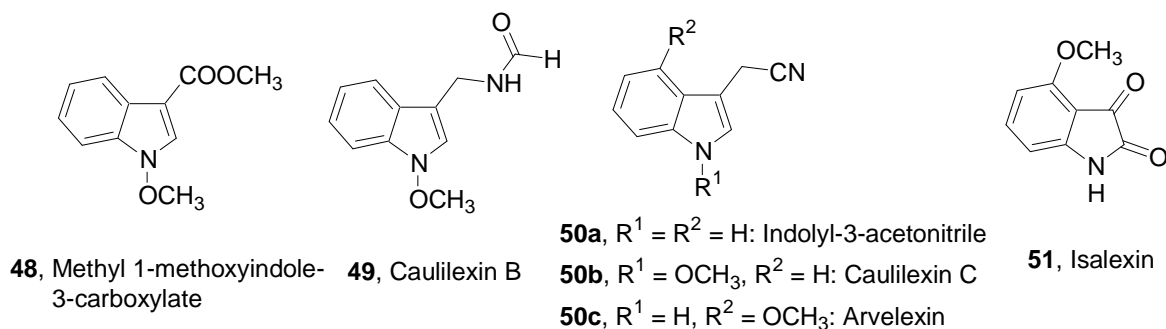
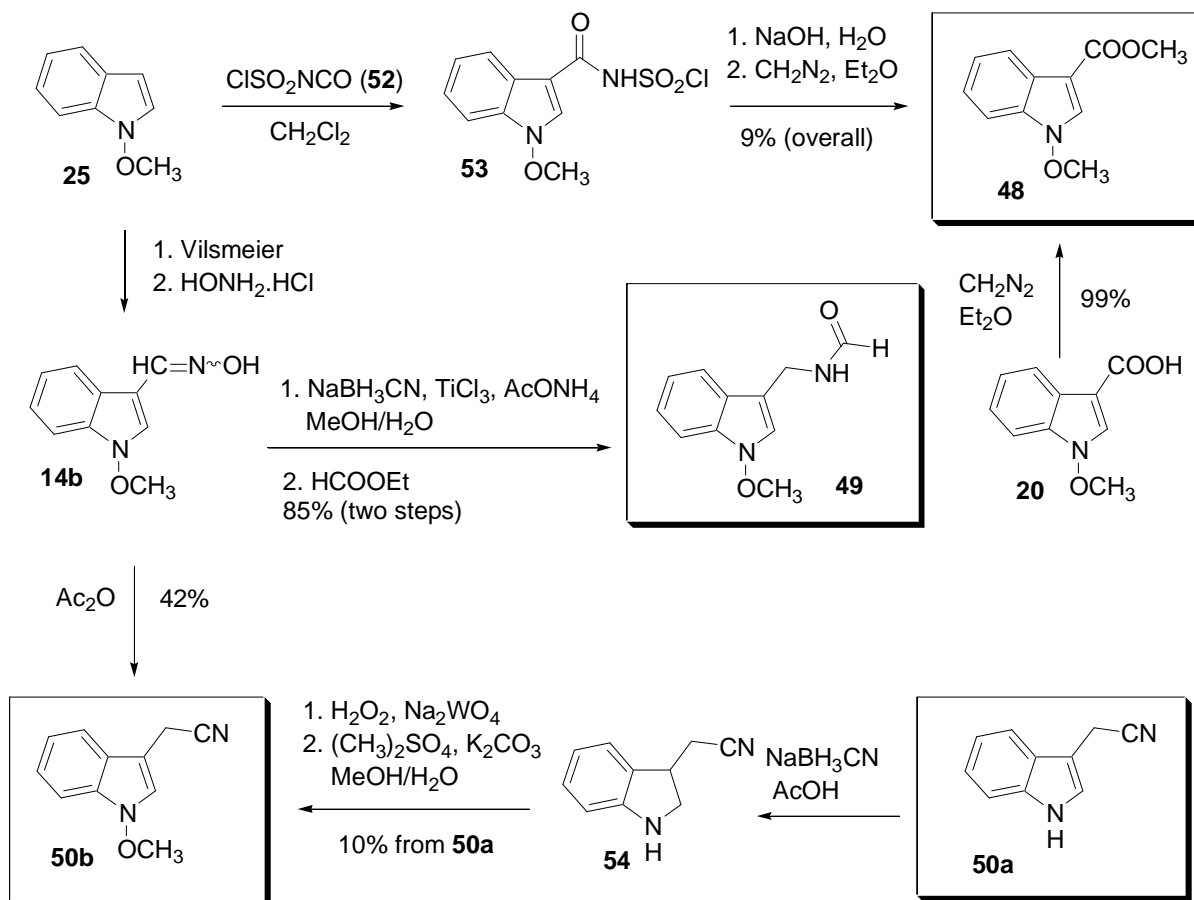

Figure 2

Methyl 1-methoxyindole-3-carboxylate (**48**) was synthesized by nucleophilic addition of 1-methoxyindole (**25**) to chlorosulfonylisocyanate (**52**), subsequent hydrolysis of chlorosulfonylamide (**53**) followed by esterification of the formed 1-methoxyindole-3-carboxylic acid in 9% overall yield^{32a} (Scheme 9). More effectively the phytoalexin **48** was prepared by methylation of acid **20** with diazomethane^{27a} (Scheme 9). Synthesis of caulilexin B also started from 1-methoxyindole (**25**) which was transformed to oxime **14b**, and amine **15b** obtained after reduction (see Scheme 1) was formylated to the target compound **49**¹⁷ (Scheme 9). Dehydration of oxime **14b** with acetic anhydride afforded caulilexin C (**50b**) that was also obtained from another phytoalexin **50a** (this simple compound is commercially available) after reduction to corresponding indoline derivative **54**, oxidation and methylation in 10% overall yield¹⁷ (Scheme 9).

The third derivative of indolyl-3-acetonitrile, arvelexin (**50c**) was synthesized by nucleophilic substitution of bromine in bromoacetonitrile with 4-methoxyindolyl magnesium bromide^{32c} (Scheme 10). Structurally simple phytoalexin isalexin (**51**, 4-methoxyisatin) was synthesized before its isolation from rutabaga.²⁰ The synthesis involves directed *ortho*-lithiation of *N*-Boc-*m*-anisidine (**56**) with BuLi followed

by treatment with diethyl oxalate. Acid-catalyzed hydrolysis of the obtained intermediate **57** resulted in spontaneous cyclization to product **51**^{32d} (Scheme 10).



Scheme 9

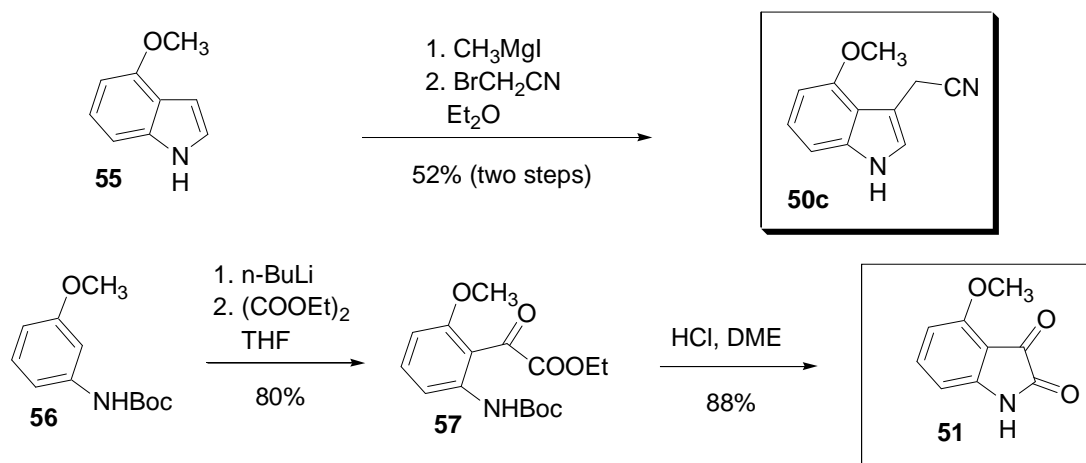

Scheme 10

2.3. 3-(Thiazole-2-yl)indole derived phytoalexins

Structure of this small group of natural products (**58**, Figure 3) is characterized by thiazole-2-yl substituent attached by σ -bond to indole 3-position. Camalexin (**58a**) and its 6-methoxy derivative **58b**

isolated from false flax^{33a} as well as 1-methyl derivative **58c** from shepherd's purse^{33b} possess the biaryl heterocyclic scaffold with unsubstituted thiazole ring. Camalexin is among the most investigated indole phytoalexins.^{33c}

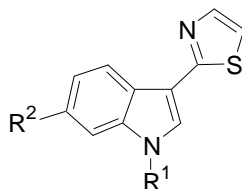

- 58a**, R¹ = R² = H: Camalexin
58b, R¹ = H, R² = OCH₃: 6-Methoxycamalexin
58c, R¹ = CH₃, R² = H: 1-Methylcamalexin

Figure 3

Several different approaches to camalexin scaffold have been developed. The most straightforward method is the coupling of indole with thiazole using the intrinsic nucleophilic nature of indole in position 3, enhanced by transformation of indole (**59a**) or 4-methoxyindole (**59b**) to corresponding indolylmagnesium bromides (**60**) and subsequent coupling of these nucleophilic species with 2-bromothiazole^{33d} (Scheme 11).

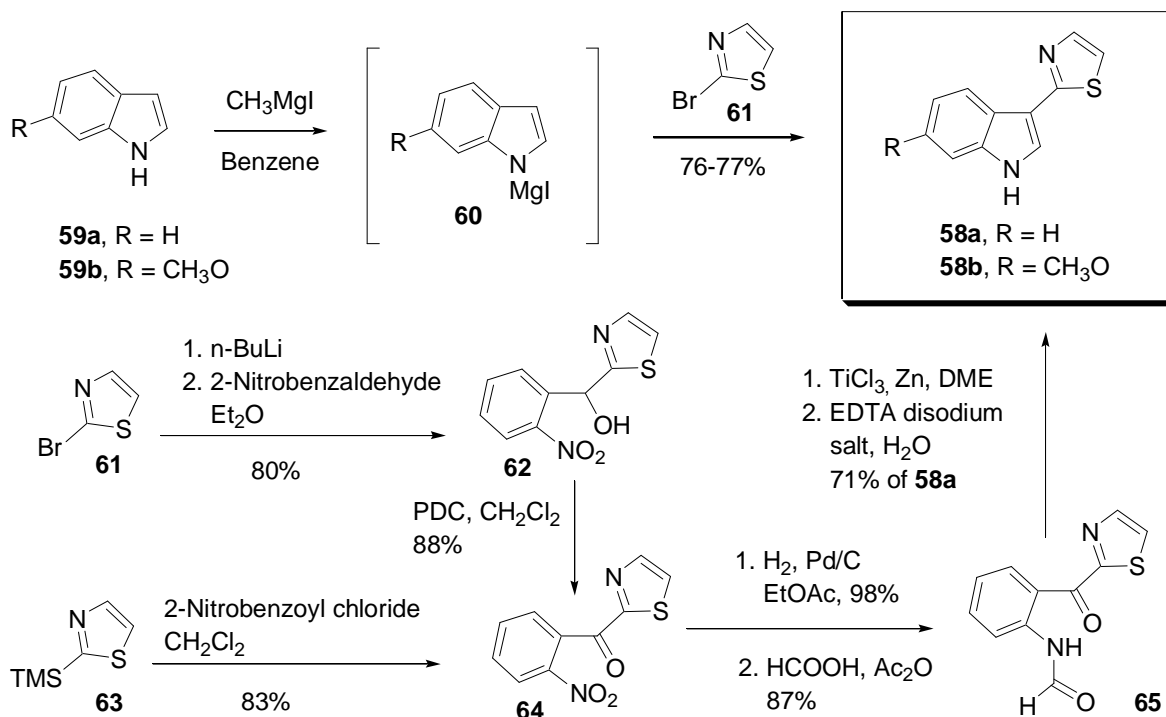

Scheme 11

Another synthesis of camalexin started from performed thiazole and indole ring was constructed. Thus 2-bromothiazole (**61**) was lithiated and treated with 2-nitrobenzaldehyde. The obtained alcohol **62** was oxidized to ketone (**64**) that can also be prepared by the reaction of 2-trimethylsilyl thiazole (**63**, Dondoni's thiazole) with 2-nitrobenzoyl chloride. Hydrogenation and subsequent formylation of resulting amino group

gave oxoamide (**65**) and its reductive cyclization resulted in the formation of camalexin (**58a**) in 71% yield (Scheme 11).^{33e} 1-Methylcamalexin (**58c**) was obtained by methylation of camalexin by treatment with sodium hydride and methyl iodide (yield not given).⁷ Construction of thiazole ring on indole nucleus represents the less effective approach to the synthesis of **58a**. Indole-3-carboxamide (**66**) was converted to camalexin in two steps in 35% overall yield by transformation to corresponding thioamide and subsequent reaction with chloroacetaldehyde diethyl acetal.^{33d}

In a biomimetic synthesis of camalexin,^{33f} cyclocondensation of 1-Boc protected aldehyde **67** with methyl L-cysteinate (**68**) produced a diastereoisomeric mixture of saturated derivative **69**, which after dehydrogenation with activated MnO₂, Boc removal and decarboxylation in basic medium afforded camalexin (**58a**, Scheme 12).

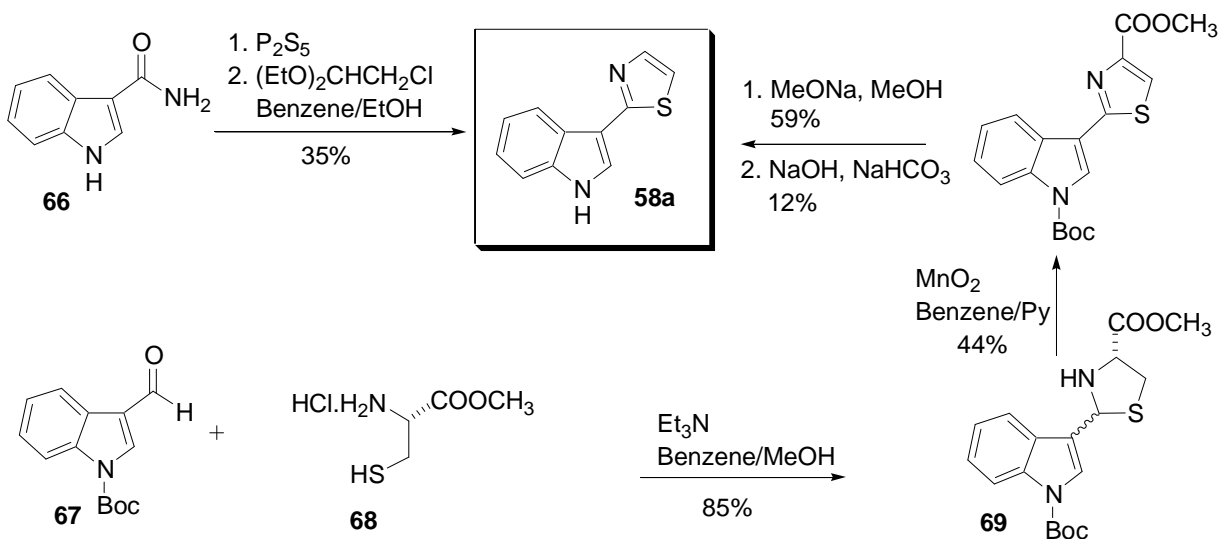

Scheme 12

2.4. 2,3-Fused indole phytoalexins

Compounds having the six- or five-membered heterocycle fused to 2,3-positions of indole ring (**70–74**, Figure 4) are characterized by thiazino[6,5-b]indole or isothiazolo[5,4-b]indole tricyclic systems. Cyclobrassinin (**70a**) isolated from Chinese cabbage was among the first discovered indole phytoalexins.² Later on, its sulphoxide **70b** from brown mustard,^{34a} corresponding 9-methoxy derivatives **70c** and **70d** from white mustard^{25e} as well as dehydro-4-methoxybrassinin (**71**) from turnip^{34b} were isolated. 4-Oxo-thiazino[6,5-b]indole derivative **72** was described to be isolated from kohlrabi in 1994.^{34c} In 2004 it was found that cyclobrassinin (**72**), is not a natural product and its structure corresponds to isomeric *N*-methyl derivative named rutalexin (**73**) isolated from rutabaga.²⁰ Isothiazoloindole phytoalexins **74** were isolated from brown mustard (**74a**)^{34d} and white mustard (**74b**).^{32a}

Compounds **70a**, **70d** and a non natural derivative **75** were prepared by modifications of the Huggershoff's oxidative bromocyclization of corresponding brassinins **1a**, **1b** and **1e**, using various bromination agents (Scheme 13). Thus the formation of electrophilic sulfur intermediate (sulfenyl bromide) was achieved by pyridinium tribromide (**70a**, 34%),² NBS (*N*-bromosuccinimide, **70a**, 35%^{23b} **75**, 20%^{34b}), dioxane dibromide (**70a**, 45%^{34e}) or phenyltrimethylammonium tribromide (**70a**, 59%^{23d}). Sinalbin B (**70d**) was prepared in 41% yield by the above mentioned bromocyclization of 1-methoxybrassinin (**1b**) with

NBS.^{25e} Oxidation of cyclobrassinin (**70a**) with MCPBA (*m*-chloroperbenzoic acid) afforded sulphoxide phytoalexin **70b** in 80% yield,^{34f} whereas analogous oxidation of **70d** resulted in the formation of **70c** in 20% yield.^{25e} Dehydrogenation of unnatural derivative of cyclobrassinin **75** by DDQ (2,3-dichloro-5,6-dicyanobenzoquinone) was used for the preparation of dehydro-4-methoxycyclobrassinin (**71**).^{34b}

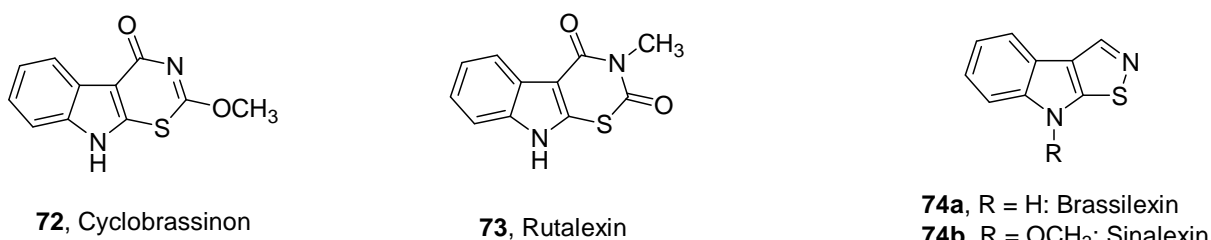
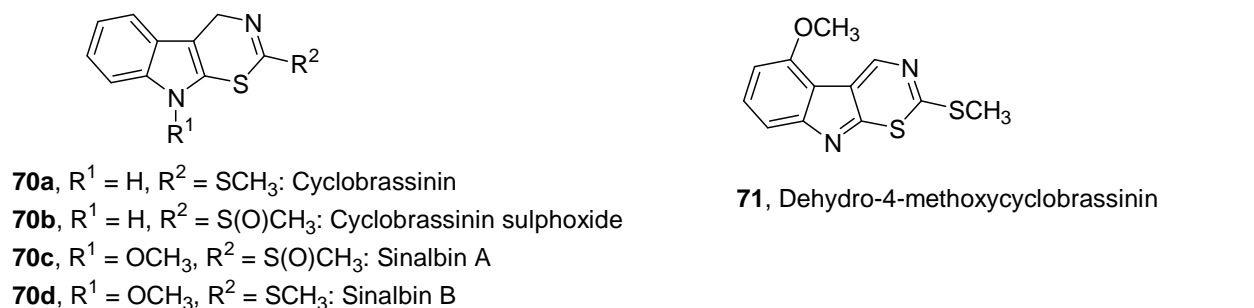
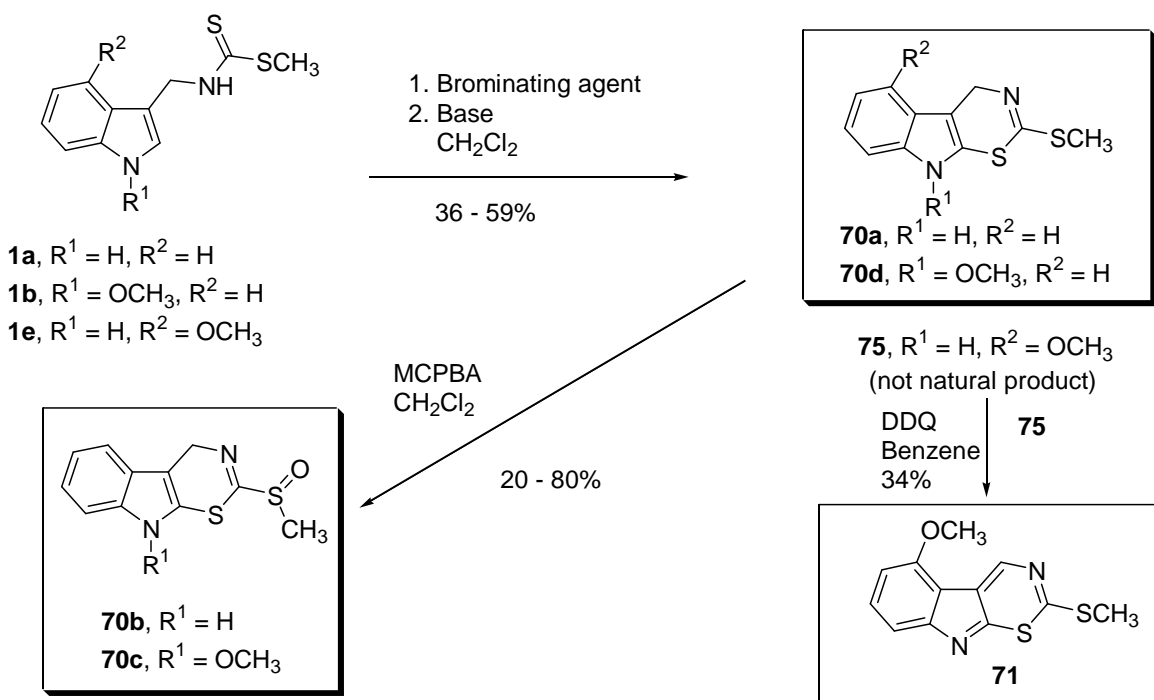

Figure 4



Scheme 13

Whereas compounds **70a** and **70d** can be prepared by various modifications of the oxidative bromocyclization of corresponding dithiocarbamate phytoalexins brassinin (**1a**) and 1-methoxybrassinin (**1b**, see Scheme 13), synthesis of 1,3-thiazinone derivatives **72** and **73** requires another approach, preferably

using derivatives of 2-chloroindole-3-carboxaldehyde as starting compounds (Scheme 14). Initially, cyclobrassinon (**72**) was synthesized, from 1-Boc-2-chloroindole-3-carboxaldehyde (**78**) by radical bromination, reaction of the obtained acid bromide with KSCN to corresponding acyl isothiocyanate **76**, which was treated with methanol, obtained carbamate cyclized and thus formed 9-Boc-cyclobrassinon (**77**) deprotected by heating without the solvent.^{35a,b} In the original paper by Gross^{34c} only the ¹H NMR (CDCl₃) and mass spectrum of putative **72** was published, melting point was not given. Although our product **72** showed identical mass spectrum, compound was not soluble in CDCl₃ and its ¹H NMR (DMSO-*d*₆) spectrum exhibited differences in chemical shifts of $\delta(\text{OCH}_3)$ at 4.18, versus 3.55^{34c} ppm and $\delta(\text{NH})$ 12.69 versus 8.56^{34c} ppm which we attributed to different solvent used.

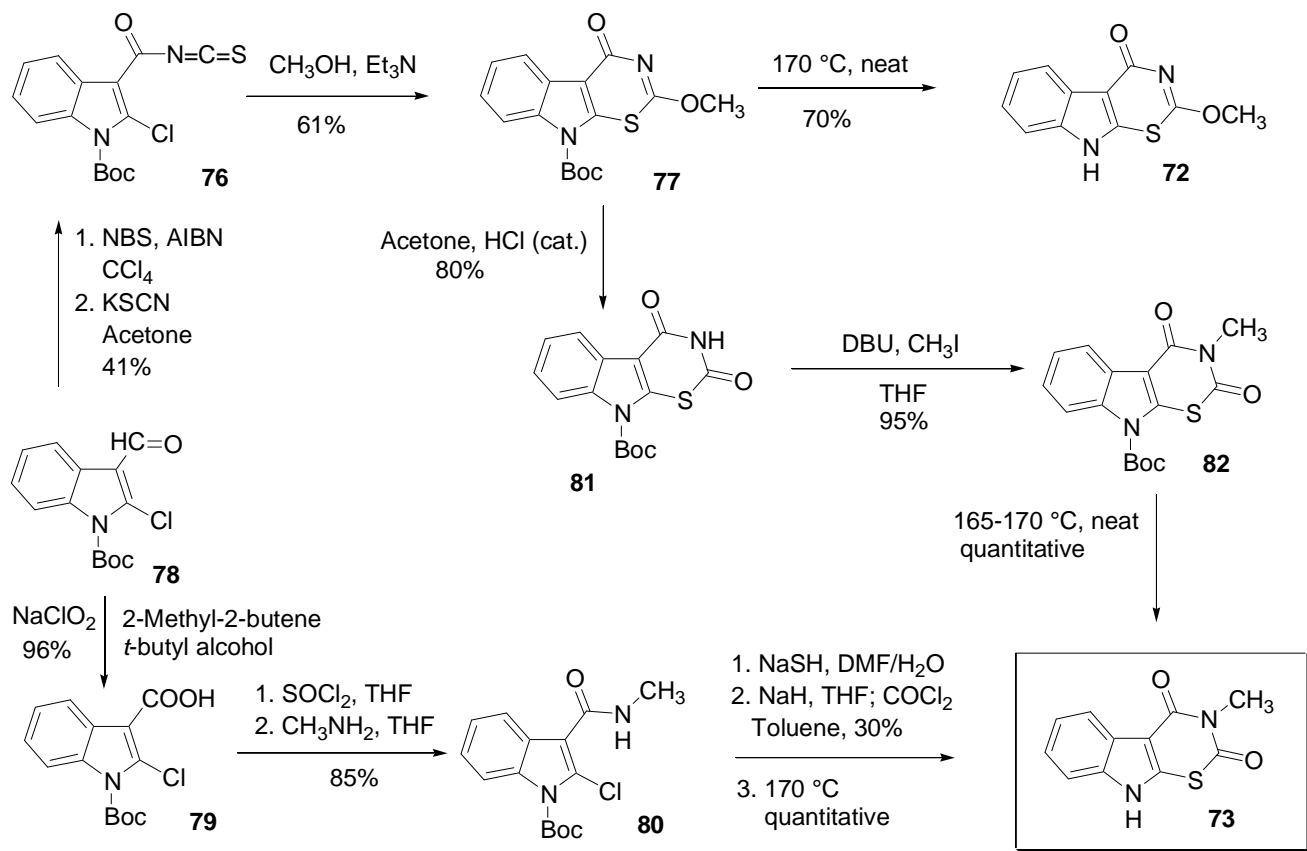

Scheme 14

Original sample for comparison was not available; however we evidenced the structure **72** by ¹³C NMR and IR spectra which were in full agreement with the expected data. In 2004 Pedras *et al.* isolated from rutabaga tubers the phytoalexin rutalexin (**73**).²⁰ Since its spectroscopic data were similar to that of cyclobrassinon, they also investigated phytoalexins produced in kohlrabi and again isolated rutalexin, but have not isolated or detected cyclobrassinon (**72**). They synthesized rutalexin (**73**) from 1-Boc-2-chloroindole-3-carboxaldehyde which was oxidized with NaClO₂ to 1-Boc-2-chloroindole-3-carboxylic acid (**79**), then transformed **79** with SOCl₂ to acid chloride which after successive treatment with methyl amine, NaSH and phosgene and subsequent deprotection afforded rutalexin (**73**, Scheme 14), identical with the natural product.²⁰ Comparison of natural rutalexin with synthetic rutalexin and cyclobrassinon showed that the structure of natural product first isolated from kohlrabi and named cyclobrassinon is identical to rutalexin

and cyclobrassinon is not a natural product. Similarly to cyclobrassinon, rutalexin showed poor solubility in CDCl_3 and its ^1H NMR spectrum recorded in $\text{DMSO}-d_6$ exhibited differences in chemical shifts of $\delta(\text{OCH}_3)$ at 3.37, versus 3.55^{34c} ppm and $\delta(\text{NH})$ 12.57 versus 8.56^{34c} ppm, caused by different solvent. We have found that toxic phosgene in reported synthesis of rutalexin may be avoided. The advanced intermediate **77** of cyclobrassinon synthesis can be effectively converted to rutalexin by a three step process consisting of acid catalyzed hydrolysis to corresponding dione **81**, subsequent *N*-methylation to 9-Boc-rutalexin (**82**) and final deprotection^{35c} (Scheme 14).

The first synthesis of brassilexin (**74a**) was achieved by PPA (polyphosphoric acid) catalyzed cyclization of sulfide **83** obtained by treatment of oxime **14a** with sulfur chloride.^{36a} In alternative synthesis, the reaction of aldehyde **13a** with sulfur chloride produced the disulfide analogous to monosulfide **83** which after treatment with ammonia afforded brassilexin (**74a**) in 30% overall yield^{36b} (Scheme 15).

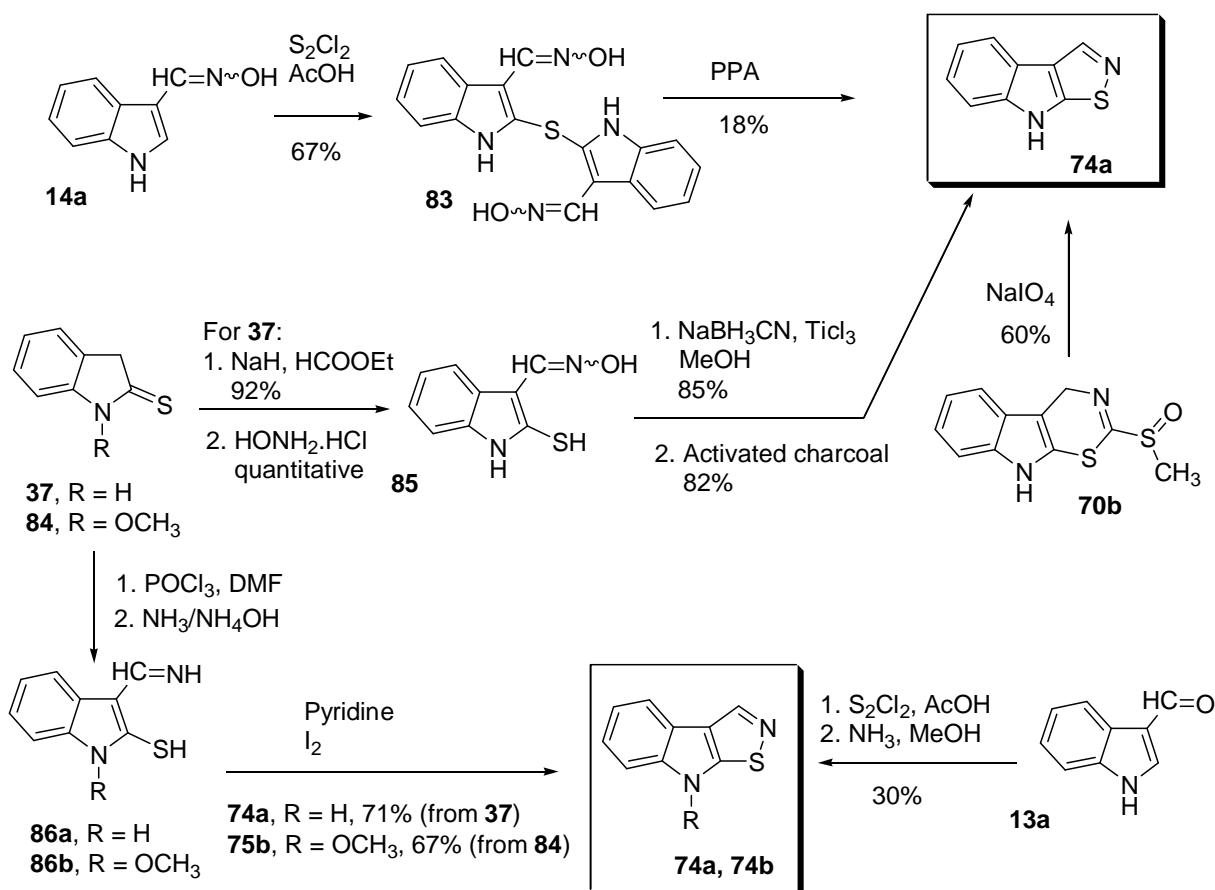

Scheme 15

Brassilexin (**74a**) was also obtained by sodium periodate mediated oxidative ring contraction of cyclobrassinin sulphoxide (**70b**)^{34f} and by treatment of cyclobrassinin with the same reagent in 30% yield.^{36c} In another efficient synthesis brassilexin (**74a**) was synthesized from indoline-2-thione (**37**) in four steps in 64% overall yield (Scheme 15). Thione **37** was formylated and *via* oxime **85** transformed to amine which cyclized on activated charcoal to brassilexin (**74a**).^{36d} The most efficient synthesis of brassilexin (**74a**) was achieved by Vilsmeier formylation of **37** followed by unprecedented ammonia workup. Obtained imine intermediate **86a** gave after oxidation with iodine the high yield of target compound^{28b,36e} (Scheme 15). The same procedure was successfully applied in the synthesis of sinalexin^{28b,36e} (**74b**, Scheme 15).

2.5. Spiroindoline[3,5']- and spiroindoline[2,5']dihydrothiazole type phytoalexins

Cruciferous phytoalexins with the spiro-attached thiazoline ring to indole 3 or 2 position (**87–91**, Figure 5) are chiral alkaloids. Their absolute configuration however was determined quite a long time after isolation. (*S*)-(-)-Spirobrassinin (**87**),^{37a} (2*R*,3*R*)-(-)-1-methoxyspirobrassinol methyl ether (**89**)^{37b} and optically inactive 1-methoxyspirobrassinol (**90**)^{37b} were isolated from Japanese radish, whereas (*R*)-(+)-1-methoxyspirobrassinin (**88**) from kohlrabi.^{34c} Compound **90** exists in solution as a mixture of diastereoisomers **90a** and **90b** in a 2:1 ratio owing to its unstable hemiaminal structure.^{37b} (+)-Erucalexin with yet unknown absolute stereochemistry was isolated recently as a phytoalexin of dog mustard.^{37c}

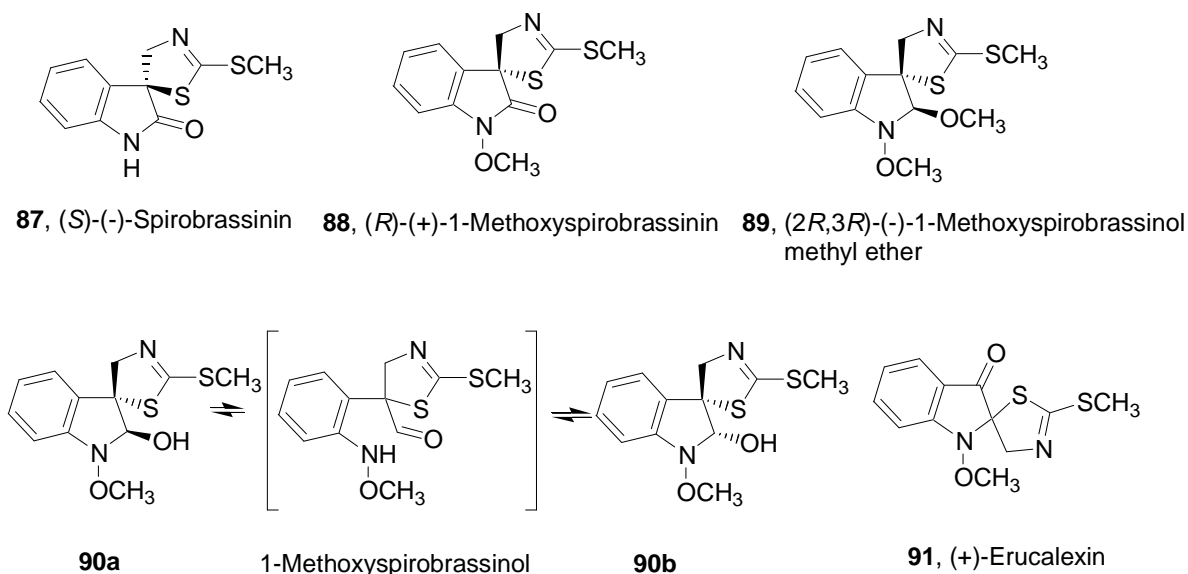
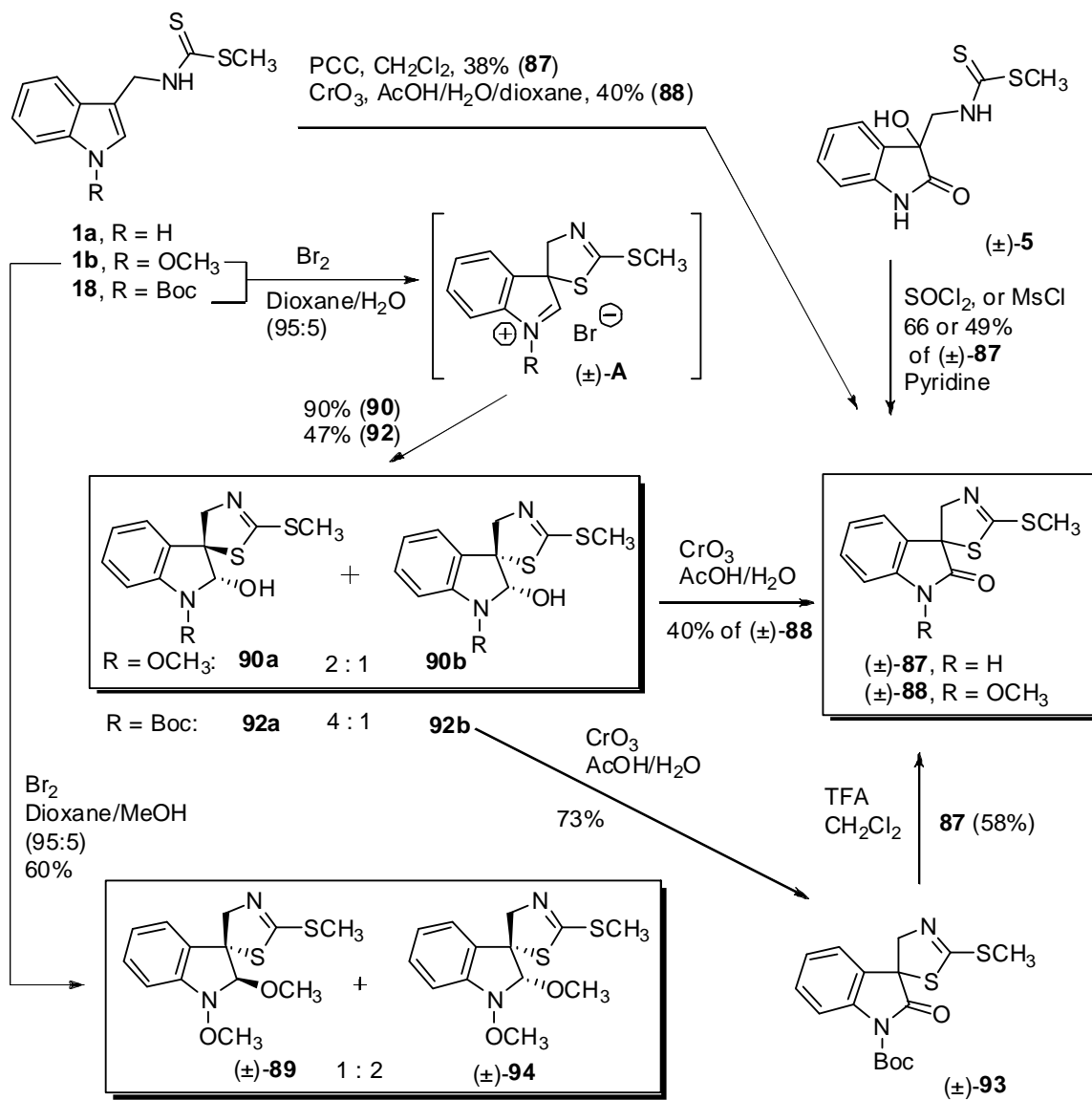

Figure 5

Racemic spirobrassinin [()-**87**] was synthesized by thionyl chloride or methanesulfonyl chloride (MsCl) mediated cyclization of dioxibrassinin [()-**5**, Scheme 16].^{29b,37d} In 2002, spirocyclization strategy toward spiroindoline phytoalexins was developed.^{34e} Treatment of 1-methoxybrassinin (**1b**) with dioxane dibromide in dioxane in the presence of 5% of water produced a mixture of diastereoisomers of 1-methoxyspirobrassinol **90a** and **90b** in 90% yield (Scheme 16). It was proposed that the primarily formed sulfenyl bromide cyclized to intermediate iminium ion **A** which reacted with water as a nucleophile. Oxidation of a mixture of diastereoisomers **90a** and **90b** afforded racemic 1-methoxyspirobrassinin [()-**88**] in 40% yield. Spirocyclization reaction in the presence of methanol produced a mixture of natural [()-**89**] and unnatural [()-**94**] diastereoisomer of 1-methoxyspirobrassinol methyl ether in a ratio 1:2. If the 1-Boc-brassinin (**18**) was cyclized in the presence of water, corresponding mixture of diastereoisomers **92a** and **92b** afforded after oxidation with CrO₃ and deprotection the racemic spirobrassinin [()-**87**, Scheme 16]. Recently a direct biomimetic oxidation of brassinin (**1a**) and 1-methoxybrassinin (**1b**) to racemic spirobrassinin [()-**87**] and 1-methoxyspirobrassinin [()-**88**] was described by their treatment with pyridinium chlorochromate (PCC) or CrO₃ in 38–40% yield.^{37c}

Natural enantiomer of spirobrassinin [(*S*)-(-)-**87**] was prepared by resolution of ()-**87** with (*S*)-(-)-1-phenylethyl isocyanate. Separation of diastereoisomers by flash chromatography and removal of amide group by sodium methoxide afforded the enantiomers (-)-**87** and (+)-**87** (Scheme 17).



Scheme 16

However diastereoisomers (+)-**96** and (+)-**97** were not suitable for determination of absolute configuration since these compounds are not crystalline. Therefore acylation with (1*S*,4*R*)-(-)-camphanoyl chloride (**98**) was employed. Flash chromatographic separation of diastereoisomers (-)-**99** and (-)-**100** was somewhat complicated by their instability on silica gel, however rapid separation, in less than 1 h, gave sufficient 22% yields of both diastereoisomers. The diastereoisomers (-)-**99** and (-)-**100** were assigned to (-)-**87** and (+)-**87** by a direct comparison of products obtained from the reactions of (-)-**87** and (+)-**87** with **98** (Scheme 17). The diastereomeric amides (-)-**99** and (-)-**100** afforded suitable single crystals which were submitted to X-ray analysis and thus absolute configuration of (-)-**87** was confirmed as *S* and that of (+)-**87** as *R*.^{29b}

Racemic 1-methoxyspirobrassinin [(±)-**88**] was separated to enantiomers by chiral HPLC and the ECD (Electronic Circular Dichroism) and VCD spectra of natural isomer (+)-**88** were compared with those of known (*S*)-(-)-spirobrassinin [(*S*)-(-)-**87**]. Because most major signals showed opposing signs, the direct comparison suggested that the absolute configuration of (+)-**88** is *R*.^{37e} Natural diastereoisomer of

1-methoxyspirobrassininol methyl ether [(±)-**89**] was prepared with improved diastereoselectivity in a ratio of ()-**89** : ()-**94** = 69 : 31 and 37% isolated yield, performing the spirocyclization with bromine in dry dichloromethane with a complex of CH₃ONa with 15-crown-5 ether as nucleophile (Scheme 18).

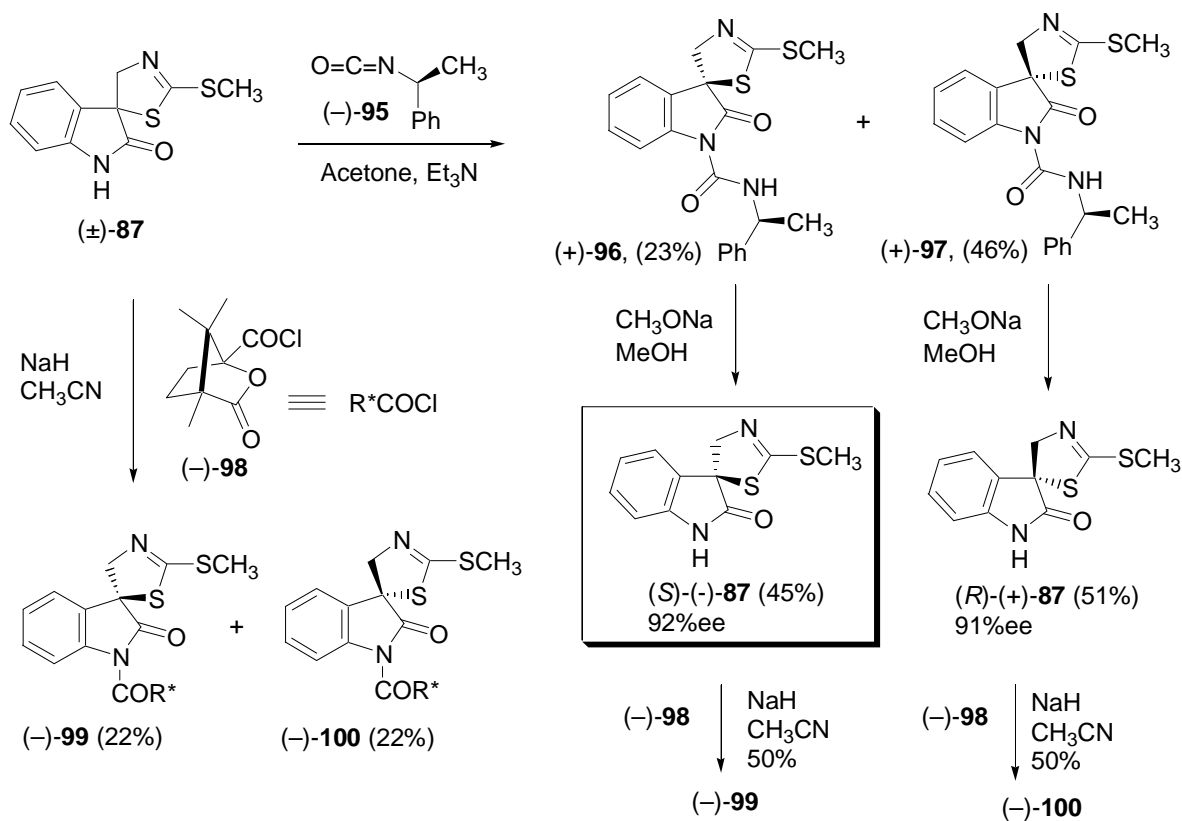

Scheme 17

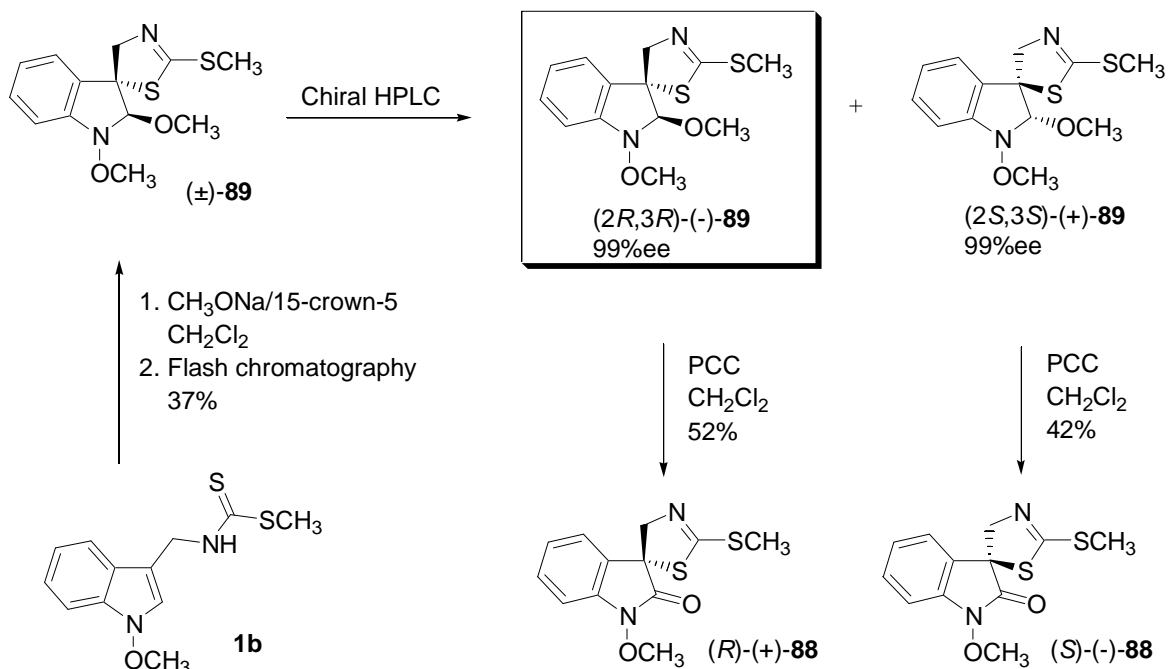

Scheme 18

It was suggested that in this case the nucleophile preferably approaches the intermediate iminium ion **A** (see Scheme 16) from the less hindered CH₂ side of thiazoline ring.^{37e} Diastereoisomer (–)-**89** was resolved to natural (–)-**89** and unnatural enantiomer (+)-**89** by chiral HPLC. Comparison of the calculated and observed VCD spectra of natural isomer (–)-**89** suggested that the absolute configuration of natural (–)-**89** is *2R,3R*. In order to confirm this result, a chemical correlation was performed. A naturally occurring (–)-**89** was transformed to 1-methoxyspirobrassinin **88** by oxidation with PCC (Scheme 18). Its ECD spectrum was identical with that of (*R*)-(+)-**88**. Analogous oxidation of unnatural (+)-**89** afforded (*S*)-(–)-**88**. Therefore with respect to its *trans*-diastereoisomeric structure (sulfur and oxygen atoms on the opposite sides of indoline ring), absolute configuration of (–)-**89** was confirmed to be *2R,3R*.^{37e}

Stereoselective synthesis of 1-methoxyspirobrassinin [(*R*)-(+)-**88**] and 1-methoxyspirobrassininol methyl ether [(*2R,3R*)-(–)-**89**] was achieved by spirocyclization of 1-methoxybrassinin in the presence of (1*S,2R,5S*)-(+)-menthol as a nucleophile reacting with the iminium intermediate **A** (Scheme 19).^{37f}

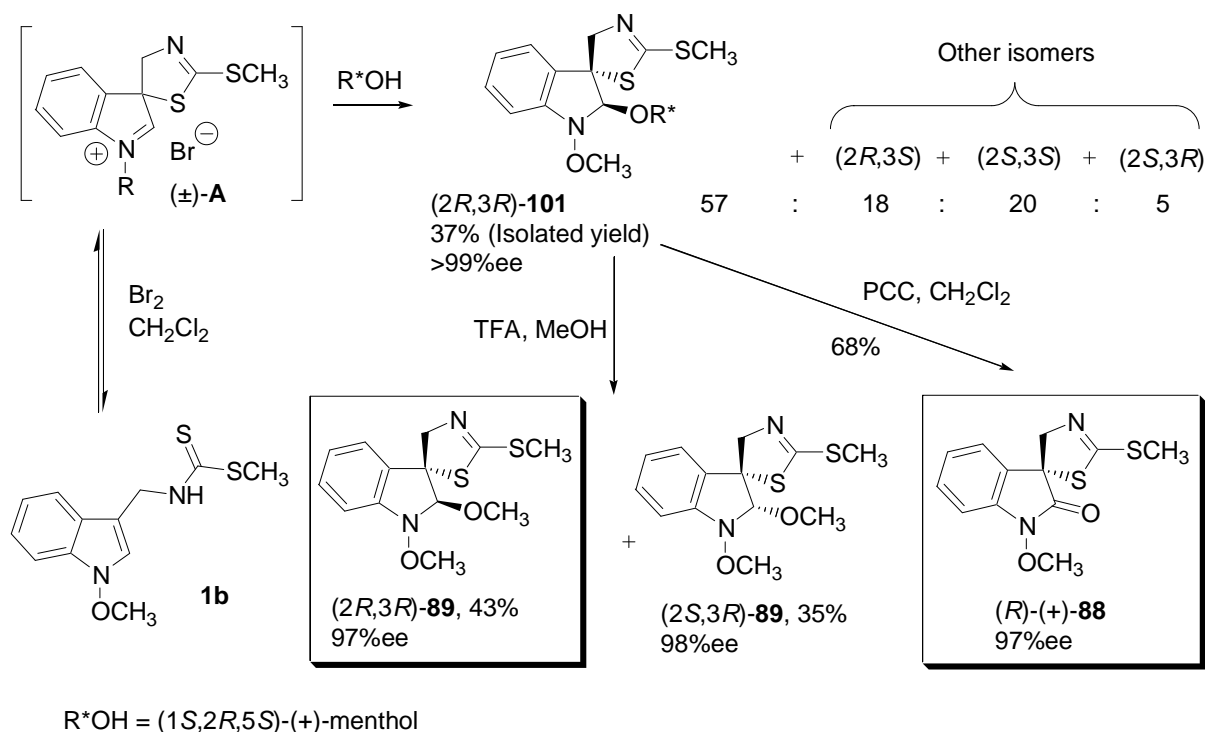

Scheme 19

It was supposed that the chiral secondary alcohol would approach methoxyiminium ion **A** from the less hindered CH₂-side of thiazoline ring in the direction of Bürgi-Dunitz trajectory and one of the possible four diastereoisomers would be major. In this model, the (*R*)-methoxyiminium ion should be preferably attacked by the 1*S*-enantiomer of the alcohol from the less hindered CH₂-side of thiazoline ring. With the 1*R*-enantiomer of alcohol the situation was expected to be opposite. The reaction with (1*S,2R,5S*)-(+)-menthol resulted in the formation of diastereoisomer (*2R,3R*)-**101** as the expected major product. Other isomers were also formed, but the main product could be isolated by column chromatography in 37% yield (Scheme 19). Oxidation of (*2R,3R*)-**101** with PCC afforded natural (*R*)-(+)-**88**, whereas its methanolysis in the presence of TFA resulted in the formation of a mixture of natural (*2R,3R*)-**89** and unnatural isomer

(2*S*,3*R*)-**89** easily separable by column chromatography.^{37f} As expected, application of (1*R*,2*S*,5*R*)-(-)-menthol resulted in the formation of products with opposite stereochemistry.^{37f}

Racemic erucalexin [(\pm)-**91**] was synthesized from 1-methoxyindole (**52**). Its lithiation, formylation of 2-indolyl lithium with dimethylformamide (DMF) and subsequent reaction with hydroxylamine afforded corresponding oxime **102**. The oxime was transformed to 1-methoxyisobrassinin (**103**) by standard procedure and the later submitted to oxidative cyclization affording [(\pm)-**91**, Scheme 20].^{37c}

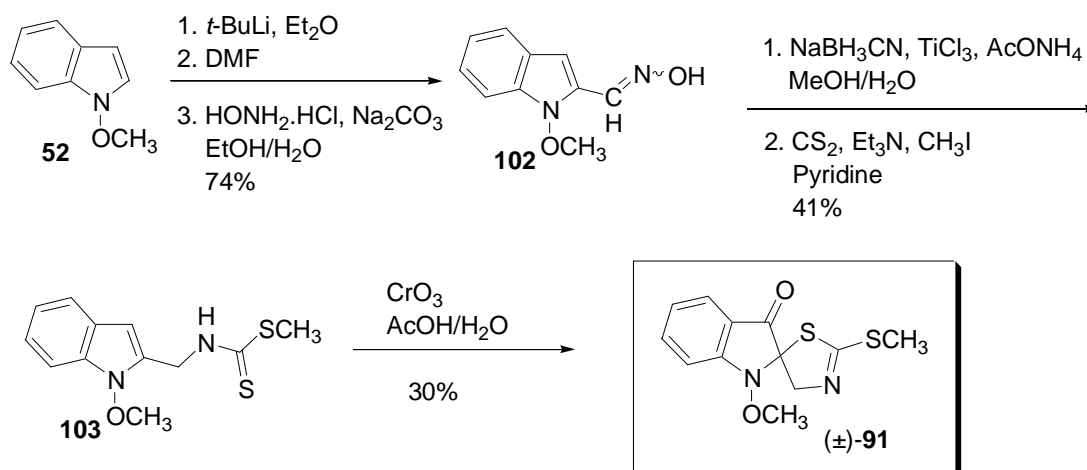

Scheme 20

3. Anticancer activity

Phytoalexins are structurally diverse group of generally lipophilic low molecular weight compounds with non-specific and not particularly potent antimicrobial activity.³⁸ Their mode of action (MOA) against plant pathogens is not well understood, but it likely involves disruption of cell membranes among variety of other biochemical and physiological processes.³⁹ In addition to their antimicrobial effects, some phytoalexins have been found to exhibit the anticancer activity against human and animal cancers. In particular, 4-ipomeanol from the sweet potato *Ipomoea batatas* infected with the fungus *Fusarium solani*, and resveratrol (*trans*-3,5,4'-trihydroxystilbene), found in *Vitis vinifera*, labrusca and muscadine grapes was evaluated in early clinical trials for cancer chemoprevention,^{40a} treatment of non-small cell lung cancer^{40b} and advanced hepatocellular carcinoma.^{40c} Several indole phytoalexins from cruciferous plants have also been shown to exert significant anticancer activity, in addition to their antimicrobial (antifungal and antibacterial) activity in pre-clinical trials. For this reason, indole phytoalexins may be interesting lead compounds for anticancer drug development.⁵

3.1. Cytostatic and cytotoxic effects

Cytotoxic effects of indole phytoalexins brassinin (**1a**), (\pm)-spirobrassinin [(\pm)-**87**] and cyclobrassinin (**70a**) were tested on murine leukemia L1210 and melanoma B16 cells using the MTT (thiazolyl blue) assay after 24 h of cultivation. The highest cytotoxic effect was induced by brassinin that at concentration 100 $\mu\text{mol} \times \text{L}^{-1}$ reduced the growth of L1210 and B16 cells by 35%, while at 10 $\mu\text{mol} \times \text{L}^{-1}$ it reduced proliferation of these cell lines by 15% and 9% of the solvent control ($p < 0.05$). Spirobrassinin was the less efficient against both cell lines and at concentration 100 $\mu\text{mol} \times \text{L}^{-1}$ reduced the cell growth of L1210 by

12% ($p < 0.05$). Spirobrassinin did not demonstrate statistically significant cytotoxic effect on L1210 cells at $10 \mu\text{mol} \times \text{L}^{-1}$ and on melanoma B16 at concentrations up to $100 \mu\text{mol} \times \text{L}^{-1}$. Similarly, under the conditions of reported experiment, cyclobrassinin (**70a**) did not exhibit significant potency against L1210 and B16 cell lines at concentrations up to $10 \mu\text{mol} \times \text{L}^{-1}$.^{41a} However, the relatively short time of exposition of cancer cells to tested drugs in reported experiment may have resulted in low sensitivity and false negative (no activity) results for some evaluated compounds at certain concentrations.

Cyclobrassinin (**70a**), brassilexin (**74a**), and their non-natural analogs, such as homocyclobrassinin and 5-methoxybrassilexin were evaluated as growth inhibitors with cultured human oral epidermoid carcinoma KB and normal monkey kidney cells. Cells were treated with tested compounds for 3 days and the effects on cell proliferation were evaluated by a neutral red-based assay. Under this experimental design, brassilexin, homocyclobrassinin and 5-methoxybrassilexin displayed comparable cytostatic/cytotoxic potencies with their respective IC_{50} values of 46, 42 and $49 \mu\text{mol} \times \text{L}^{-1}$, while cyclobrassinin was less potent with IC_{50} value of $99.4 \mu\text{mol} \times \text{L}^{-1}$. However, the IC_{50} of brassilexin on the normal monkey kidney cells was found to be the same as for the human KB carcinoma cells ($46 \mu\text{mol} \times \text{L}^{-1}$), and this lack of selectivity for cancer cells was interpreted as a general cytotoxicity effect that, together with relatively low magnitude of antiproliferative effect, discouraged further *in vivo* evaluations of these compounds.^{41b} Furthermore, according to another report, some indole phytoalexins, *e.g.* 1-methoxyspirobrassinin (**88**) and 1-methoxyspirobrassinol (**90**) may in fact exhibit a stimulating effect on proliferation of human breast cancer MCF-7 and human colorectal carcinoma CACO-2 cells.^{41c} In a view of the above findings, the effects of indole phytoalexins on cancer cells are very complex and there is a great need for an in depth understanding of their mode of action and structure-activity relationships.

More promising results were obtained by an evaluation of antiproliferative activity of camalexin (**58a**) against the human breast cancer cell line SKBr3 (which overexpresses topoisomerase II α) by MTT assay. Camalexin exhibited remarkable antiproliferative activity against SKBr3 cells after 4-day treatment ($\text{IC}_{50}=2.7 \mu\text{mol} \times \text{L}^{-1}$) and was more potent than cisplatin ($\text{IC}_{50}=7.4 \mu\text{mol} \times \text{L}^{-1}$) and melphalan ($\text{IC}_{50}=13.0 \mu\text{mol} \times \text{L}^{-1}$). On the other hand, the antiproliferative activity of camalexin against SKBr3 was significantly lower compared to agents such as mitoxantrone ($\text{IC}_{50}=0.016 \mu\text{mol} \times \text{L}^{-1}$), etoposide ($\text{IC}_{50}=0.60 \mu\text{mol} \times \text{L}^{-1}$), and amsacrine ($\text{IC}_{50}=0.16 \mu\text{mol} \times \text{L}^{-1}$) which are known to act *via* inhibition of topoisomerase II.^{41d} For this reason, antiproliferative effect of camalexin presumably does not include inhibition of topoisomerase II, in spite of its close structural resemblance with natural thiazolyl indolequinone BE 10988 which has anticancer properties and acts as an inhibitor of topoisomerase II.^{41e}

According to another report, brassinin (**1a**), its non-natural isomer isobrassinin and its analog isocyclobrassinin exhibit significant inhibitory effects of on the growth of human cervical cancer HeLa, human breast adenocarcinoma MCF-7, and human epidermoid carcinoma A431 cells (MTT assay; 72 h treatment by drugs at $30 \mu\text{mol} \times \text{L}^{-1}$). Isocyclobrassinin demonstrated highest potency against both MCF-7 and A431 cells with $\text{IC}_{50} < 10 \mu\text{mol} \times \text{L}^{-1}$. Moreover, 2-phenylimino-1,3-thiazino[5,6-b]indole, structurally related to isobrassinin, at a concentration $10 \mu\text{mol} \times \text{L}^{-1}$ showed on MCF-7 cells comparable potency to that of anticancer agent cisplatin with growth inhibition to about 50% of the control.^{41f}

Brassinin (**1a**), 1-methoxybrassinin (**1b**), (\pm)-spirobrassinin [(\pm)-**87**], (\pm)-1-methoxyspirobrassinin [(\pm)-**88**], and 1-methoxyspirobrassinol (**90**, mixture of diastereoisomers) were also found to inhibit growth of human T-ALL Jurkat cells after 72-h treatment at a concentration of $100 \mu\text{mol} \times \text{L}^{-1}$ to 55.6%, 38.2%,

49.0%, 50.1%, and 49.6% respectively. In all of these cases, the growth of treated cells was significantly different to that of untreated control ($p < 0.01$). 1-Methoxybrassinin (**1b**), the most efficient compound in this report, was shown to induce apoptosis in treated Jurkat cells after 24 hours (cell cycle distribution by flow cytometry; DNA fragmentation assay by agarose electrophoresis), and after 72 hours (by flow cytometry using Annexin V/propidium iodide staining).^{41g}

1-Methoxybrassinin B (**2b**) and its demethoxy analog brassinin B demonstrated by MTT test cytostatic/cytotoxic effects on human breast MCF-7 and cervical HeLa cancer cells and on human T-acute lymphoblastic leukemia cells Jurkat, CEM and CEM-VCR, at drug concentrations of $100 \mu\text{mol} \times \text{L}^{-1}$ and 72-h incubation. In this experiment both compounds inhibited growth of cancer cells by at least 50% of the control with 1-methoxybrassinin B (**2b**) being more potent. In contrast, their nucleoside analogs 1-(α -D-ribofuranosyl)brassinin B, 1-(β -D-ribofuranosyl)brassinin B and 1-(β -D-glucopyranosyl)brassinin B did not exhibit significant activity under the same conditions, with the notable exception of 1-(α -D-ribofuranosyl)brassinin B that inhibited growth of HeLa cells to about 58%. Acetyl and isopropylidene protecting groups on sugar hydroxyls partially reversed the loss of activity caused by glycosylation of brassinin B, which was interpreted in terms of the increased activity with the increased hydrophobicity of these molecules.^{27b} This report does not provide statistical analysis of its biological results, therefore it is impossible to conclude how significant are differences in potencies between compounds and between cell lines. Nevertheless, there appears to be small, if any difference, in potencies of all tested compounds between CEM and vincristine-resistant subline CEM-VCR. Phenotype of CEM-VCR cell line used in this screening was previously characterized by other investigators as P-glycoprotein (P-gp) and Lung Resistance Protein (LRP) positive.^{41h} As a result, a conclusion can be drawn that 1-methoxybrassinin B (**2b**) and brassinin B are not substrates of these multidrug resistance-related proteins. This conclusion, not stated in the original report, is of great significance with respect to anticancer properties of 1-methoxybrassinin B and brassinin B and possibly other indole phytoalexins.

In order to investigate the effects of chirality of indole phytoalexins on anticancer response, chiral indole phytoalexins 1-methoxyspirobrassinin (**88**) and 1-methoxyspirobrassinol methyl ether (**89**) were recently prepared in their individual enantiomeric forms and their cytostatic/cytotoxic effects were evaluated. The natural (*2R,3R*) enantiomer of 1-methoxyspirobrassinol methyl ether (**89**) was much more potent inhibitor of Jurkat cells proliferation than its (*2S,3S*) enantiomer (cell growth 36.9% vs. 79.8% of the control), while in the case of 1-methoxyspirobrassinin there was overall weak activity against Jurkat cells with no differences between its enantiomers.^{37e} This finding suggests that 1-methoxyspirobrassinol methyl ether with moderate antiproliferative activity and significant difference in activities of its enantiomers has some chiral molecular target in a cell, which preferably interacts with more potent (*2R,3R*) enantiomer (eutomer), while weak antiproliferative effect of 1-methoxyspirobrassinin (**88**) is mediated through some other mode of action where target is not chiral or its chirality is not involved in the underlying mode of action.

The mode of action by which indole phytoalexins inhibit proliferation of cancer cells and induce apoptosis has not been elucidated yet. Some possible mechanisms and cellular targets have been suggested from structural similarities of indole phytoalexins to the other compounds with known mechanisms involved in anticancer activity. Specifically, brassinin, spirobrassinin as well as some of their analogs belong to the group of dithiocarbamates (DTC), some of which also demonstrate anticancer effects *via* inhibition of

nuclear factor kappa B (NF- κ B)^{42a} and proteasome^{42b} activities. Some DTC, such as proline dithiocarbamate and diethyl dithiocarbamate induce p53-dependent expression of p21/KIP1/CIP1 leading to G₁/S arrest, as was demonstrated in human hepatoma Hep G2 cells.^{42c} DTC also trigger the expression of myeloid differentiation antigens and inhibit proliferation of human promonocytic leukemia U-937 cells through mechanism that involves activation of the transcription factor AP-1.^{42d}

NF- κ B plays a pivotal role in immune response, cell growth and regulation of apoptosis. Activation of NF- κ B associated with certain apoptotic stimuli (TNF, ionizing radiation, certain chemotherapeutic compounds) has been found to protect cells from apoptosis induced by these stimuli. In addition, inhibition of NF- κ B activation potentiates apoptosis induced by these agents. As the resistance to cancer therapies appears to be mediated by resistance to apoptosis, these agents are less effective for cancer therapy due to simultaneous activation of NF- κ B. For this reason, new approaches to cancer therapy that inhibit activation of NF- κ B may prove to be highly effective in the treatment of various cancers.^{42e} Inhibition of NF- κ B by 3,3'-diindolylmethane was shown to increase sensitivity of MDA-MB-231 cells to docetaxel-induced apoptosis^{42f} and this finding supports prospective therapeutic value of NF- κ B inhibitors in combination with certain apoptosis inducing chemotherapeutic agents. Inhibition of NF- κ B signaling by DTC is caused, at least in part, by inhibition of proteasome. Proteasome inhibition prevents ubiquitin-proteasome pathway to degrade I κ B and cyclins, which in turn blocks activation of NF- κ B and cell proliferation, respectively.^{42g}

Spirobrassinin and some of its analogs can possibly stimulate the activity of p53 tumor suppressor through blocking its interaction with mdm2 oncoprotein. Spirooxindoles, including 6-chloro-4'-(3-chlorophenyl)-2'-(2,2-dimethylpropyl)-2-oxo-1,2-dihydrospiro[indole-3,3'-pyrrolidine]-5'-carboxylic acid dimethylamide, were identified by structure-based drug design and experimentally confirmed as potent inhibitors of p53-mdm2 interaction.^{42h} This mechanism may be involved in activity of these compounds against approximately 50% of human cancers where p53 retains its wild-type form but its activity is inhibited by the mdm2 oncoprotein interacting directly with p53 and targeting it for degradation by ubiquitin-proteasome pathway.⁴²ⁱ

Mode of action of some indole phytoalexins, *e.g.* brassinin, 4-methylbrassinin and cyclobrassinin in estrogen receptor (ER)-positive cells can also be mediated by enhanced C2-hydroxylation of estradiol (E2) leading to its conversion to anticarcinogenic 2-hydroxyestrone (2-OHE1). Treatment of stable myc transfectant mammary epithelial cells MMEC/myc3 with above mentioned indole phytoalexins at non-cytotoxic concentrations (10 μ mol \times L⁻¹) resulted in suppression of anchorage-independent cellular growth and the increase of 2-OHE1.^{43a} In ER-positive human cancer cells MCF-7, E2 increases expression of protooncogen c-myc, while growth-inhibiting antiestrogen tamoxifen reduces c-myc expression.^{43b} Consequently, indole phytoalexins appear to inhibit cell proliferation of ER-positive cells *via* inhibition of c-myc signaling at least in part through up-regulated C2-hydroxylation of E2.

In addition, some indole phytoalexins may exhibit their anticancer effects by depletion of cellular glutathione. 2-Piperidyl analogs of 1-methoxyspirobrassinin namely *cis*-1-methoxy-, *cis*-1-Boc-, *trans*-1-methoxy- and *trans*-1-Boc-2-deoxy-2-(1-piperidyl)spirobrassinin (**104a–105b**, Scheme 21) were shown to exert a remarkable glutathione-depleting effects on MCF-7 cells. As cellular glutathione is often involved in multidrug resistance of cancer cells to some anticancer agents and radiation, these compounds could be developed as radio- and/or chemosensitizing agents for combination cancer chemotherapy.⁴⁴ Potentiation of vincristine-induced cytostatic/cytotoxic effects on human glioblastoma U-87 MG cells has already been

demonstrated for brassinin (**1a**), spirobrassinin (**87**), 1-methoxyspirobrassinin (**88**) and 1-methoxy-spirobrassinol (**90**).^{41c}

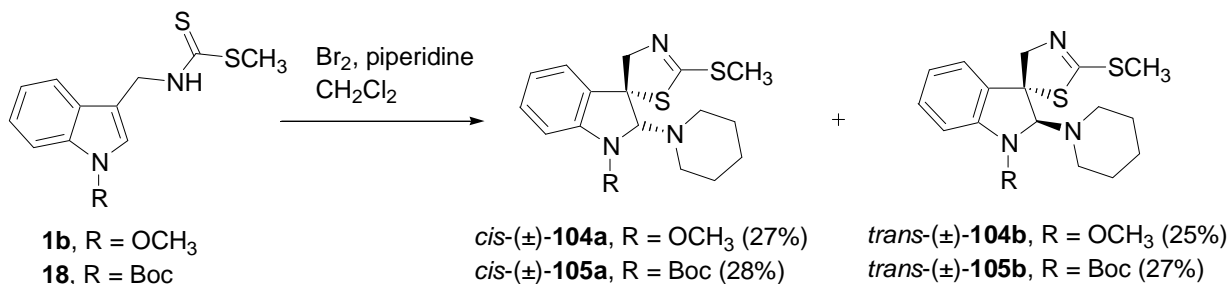

Scheme 21

3.2. Cancer chemopreventive activity

Chemoprevention of cancer is a pharmacological approach to arrest or reverse the process of carcinogenesis, and thus to prevent cancer, as contrasted with conventional chemotherapy for treatment of an existing disease.^{45a} In recent decades, considerable attention has been directed towards cancer prevention by natural products.^{45b} According to the results of six prospective epidemiological studies, the consumption of brassica vegetables, including cabbages, kale, broccoli, Brussels sprouts and cauliflower, is inversely associated with the risk of lung cancer, stomach cancer and all cancers together. Similarly, 64% of 74 case-control epidemiological studies found inverse association between the consumption of one or more brassica vegetables and risk of lung, stomach, colon and rectal cancers. The protective effect of brassica vegetables is attributed to indoles and isothiocyanates formed upon hydrolysis of glucosinolates by the plant enzyme myrosinase and gastrointestinal microflora.^{45c,d} These findings also inspired research of the possible role of indole phytoalexins in chemopreventive potential of crucifers. The chemopreventive effects of brassinin (**1a**), cyclobrassinin (**70a**) and non-natural compound 2-methylbrassinin were evaluated in the model of mammary carcinogenesis based on 7,12-dimethylbenz[*a*]anthracene (DMBA)-induced precancerous lesions in mouse mammary gland organ culture.^{45e} There appeared a good correlation between the chemopreventive activity in this assay and *in vivo* carcinogenesis, and agents showing chemopreventive activity in this organ culture experiment often show chemopreventive activity in *N*-methyl-*N*-nitrosourea or DMBA-induced mammary *in vivo* carcinogenesis in Sprague-Dawley rats.^{45f,g} The obtained results indicated that brassinin (**1a**) and cyclobrassinin (**70a**) were comparably active inhibitors of pre-neoplastic mammary lesions formation in the cell culture. Both compounds inhibited the incidence of mammary lesions in a dose dependent manner, and at concentration 10 μmol × L⁻¹ there was 80.0% (brassinin) and 90.9% (cyclobrassinin) reduction in the number of mammary glands with lesions, as compared to the control glands incubated with a vehicle. However, 2-methylbrassinin was not significantly active in this experiment, which together with the fact that cyclobrassinin is biosynthetically derived by oxidative cyclization of brassinin lead to a possible conclusion, that oxidative cyclization of brassinin may be a metabolic activation step.^{23b} Significant chemopreventive activity in the model of mouse mammary carcinogenesis was also demonstrated for cyclobrassinin (91.0%), spirobrassinin (76.3%), brassinin (73.0%) and *N*-ethyl-2,3-dihydrobrassinin (66.3%) at a concentration of tested drugs 10 mg × L⁻¹. Several methyl substituted analogues of brassinin (4-methylbrassinin, 5-methylbrassinin, 7-methylbrassinin) and 5-chlorobrassinin

exhibited destruction to the mammary glands and therefore these substances were considered to be toxic in this model.^{45h} Furthermore, brassinin (**1a**) exhibited dose-dependent inhibition of DMBA-induced mouse skin tumors, promoted by TPA (12-*O*-tetradecanoylphorbol-13-acetate) in CD-1 mice. In this two-stage skin carcinogenesis model, brassinin inhibited formation of tumors only when present during the TPA treatment phase and additional protection was not achieved when brassinin was present during both initiation and promotion phases of experiment. These data support inhibition of carcinogenesis during the promotion phase but do not exclude inhibition during the initiation phase.^{23b}

The mechanism of chemopreventive activity of cruciferous indole phytoalexins has not been elucidated yet. According to Wattenberg,⁴⁵ⁱ there are three main categories of cancer chemopreventive agents: (i) agents that prevent carcinogen formation; (ii) blocking agents (anti-initiators) that are effective when administered prior to, or simultaneously with the carcinogen and that may either inhibit the metabolic activation of pro-carcinogens or enhance detoxification and scavenge the ultimate carcinogens prior to their action; and (iii) suppressing agents (anti-promoters) that are also effective when given subsequently after administration of carcinogen during tumor promotion. Since the brassinin and cyclobraassinin have induced 4- and 29-fold increase of a phase II detoxification enzyme NAD(P)H:quinone oxidoreductase activity (QR) in mammary gland organ culture, it appears that in this concept brassinin and cyclobraassinin belong to the group of anti-initiators. On the other hand, in the two stage skin carcinogenesis model brassinin acted as an anti-promoter showing inhibition of promotional stage of carcinogenesis.^{23b}

With respect to their cancer chemopreventive properties, a bit alarming is the predicted mutagenicity of spirobrassinin (**87**) and 1-methoxyspirobrassinol methyl ether (**89**). Although this prediction was performed only by *in silico* screening and needs to be experimentally confirmed, it casts doubts about the future role of some indole phytoalexins in cancer chemoprevention.^{41c}

3.3. Modulation of immune response

Another critical finding regarding the anticancer effects of indole phytoalexins is associated with the activity of indoleamine 2,3-dioxygenase (IDO). IDO (EC 1.13.11.42) is an interferon-gamma (IFN- γ)-inducible enzyme that catalyzes the initial and rate-limiting step in the degradation of the essential amino acid tryptophan. Elevated tryptophan catabolism was found in a wide variety of human cancers and this finding was historically interpreted as a consequence of tumoricidal effect of IFN- γ . However, IDO activity was later found as a requirement for physiological protection of the allogenic fetus from rejection by maternal immune system and the available evidence suggests that malignant tumors can exploit IDO-mediated immune tolerance to promote immune escape.^{46a} For this reason, IDO became an important drug target for anticancer drugs development that may expand the options of cancer immunotherapy by low molecular weight compounds.^{46b}

Brassinin (**1a**) was found to be a moderate inhibitor of IDO,²⁶ and this finding opened a new avenue for anticancer drug development based on indole phytoalexins. It is important to emphasize that this mode of action could not be involved in reported *in vitro* cytotoxicity (see part 3.1.) and cancer chemopreventive activity (see part 3.2.), except for the mouse skin carcinogenesis model, and thus it represents an additional (indirect) anticancer mechanism of the indole phytoalexins in addition to their cytostatic/cytotoxic and anti-initiator effects. Structure-activity relationships study of brassinin derivatives as IDO inhibitors revealed that dithiocarbamate moiety, but not indole ring, is necessary for IDO inhibition. Furthermore, substitution of *S*-

methyl group of brassinin with large aromatic groups increased *in vitro* IDO-inhibitory activity by 3 times above the standard IDO inhibitor 1-methyl-tryptophan.²⁶ Recently, the role of inhibition of IDO in anticancer effects of brassinin and its pharmacologically more stable derivative 5-bromobrassinin was validated *in vivo*. Specifically, in mice bearing B16-F10 melanoma isografts, treatment with 5-bromo-brassinin produced significant suppression of tumor growth, but this effect was not observed in athymic nude mice and in genetically modified mice with functional disruption of both alleles for *Indo* gene.^{46c} Furthermore, 5-bromo-brassinin administered by oral bolus at 400 mg/kg dose significantly potentiated paclitaxel-induced regression of autochthonous mammary gland carcinomas in MMTV-*Neu* mice.^{46c} These results strongly support IDO inhibition as essential component of the antitumor mode of action of brassinin and 5-bromo-brassinin *in vivo* and indicate possible benefits of combined therapy by IDO-inhibitors targeting tumor tolerance and conventional anticancer drugs.

4. Conclusion

Chemical synthesis is a powerful tool, frequently applied in the natural products studies. Synthesis of cruciferous indole phytoalexins is no exception of this general rule, since the isolation from plants is time consuming and affords only a very small quantities of these natural products, frequently insufficient for the study of their structure and biological properties. Only little attention has been devoted to syntheses of chiral phytoalexins, probably because their absolute configuration was not known until recently. The search for new approaches to achieve high yielding and stereoselective syntheses of these natural products and their analogs is very important since these substances exhibit promising biological, particularly anticancer properties. Various indole phytoalexins exhibit cytostatic/cytotoxic effects on cultured leukemia and solid tumor cell lines *in vitro*, as well as cancer chemopreventive effects on models of mammary and skin carcinogenesis by inhibition of initiation and promotion phases of chemical carcinogenesis. Recently, 5-bromobrassinin was reported as the first indole phytoalexin-related compound inhibiting growth of solid tumors *in vivo* both in monotherapy and in combination therapy with conventional anticancer agent paclitaxel. In spite of their relatively mild cytostatic/cytotoxic effects, and in some cases pro-proliferative and probably also mutagenic effects, some of these compounds may be developed as prospective drugs for combination anticancer chemo/immuno/radio-therapy due to their remarkable glutathione-depleting and/or immune-tolerance suppressing effects. To achieve this goal, further *in vivo* studies as well as identification of molecular targets of phytoalexins and their structure-activity relationships are needed.

Acknowledgment

This work was supported by the Slovak Research and Development Agency under the contract No. APVV-0514-06.

References

1. Purkayastha, R. P. *Progress in Phytoalexin Research during the Past 50 Years* In *Handbook of Phytoalexin Metabolism and Action*; Daniel, M.; Purkayastha, R. P., Eds.; Marcel Dekker: New York, 1995; p. 1.
2. (a) Takasugi, M.; Katsui, N.; Shirata, A. *J. Chem. Soc., Chem. Commun.* **1986**, 1077. (b) Takasugi, M.; Monde, K.; Katsui, N.; Shirata, A. *Bull. Chem. Soc. Jpn.* **1988**, *61*, 285.
3. Rouxel, T.; Kollman, A.; Balesdent, M.-H. *Phytoalexins from Crucifers* In *Handbook of Phytoalexin Metabolism and Action*; Daniel, M.; Purkayastha, R. P., Eds.; Marcel Dekker: New York, 1995; p. 229.

4. Gross, D. J. *Plant. Dis. Prot.* **1993**, *100*, 281.
5. Mezencev, R.; Mojžiš, J.; Pilátová, M.; Kutschy, P. *Neoplasma* **2003**, *50*, 239.
6. Pedras, M. S. C.; Okanga, F. I.; Zaharia, I. L.; Khan, A. Q. *Phytochemistry* **2000**, *53*, 161.
7. Pedras, M. S. C.; Jha, M.; Ahiahonu, P. K. W. *Curr. Org. Chem.* **2003**, *7*, 1635.
8. Ruszkowska, J.; Wrobel, J. T. *Adv. Exp. Med. Biol.* **2003**, *527*, 629.
9. Pedras, M. S. C.; Zheng, Q.; Sarma-Mamillapale, V. H. *Nat. Prod. Commun.* **2007**, *2*, 319.
10. (a) Kutschy, P.; Achbergerová, I.; Dzurilla, M.; Takasugi, M. *Synlett* **1997**, 289. (b) Kutschy, P.; Dzurilla, M.; Takasugi, M.; Török, M.; Achbergerová, I.; Homzová, R.; Rácová, M. *Tetrahedron* **1998**, *54*, 3549.
11. Monde, K.; Takasugi, M.; Shirata, A. *Phytochemistry* **1995**, *39*, 581.
12. Monde, K.; Sasaki, K.; Shirata, A.; Takasugi, M. *Phytochemistry* **1990**, *29*, 1499.
13. Monde, K.; Sasaki, K.; Shirata, A.; Takasugi, M. *Phytochemistry* **1991**, *30*, 3921.
14. Pedras, M. S. C.; Sorensen, J.; Okanga, F. I.; Zaharia, I. L. *Bioorg. Med. Chem. Lett.* **1999**, *9*, 3015.
15. Monde, K.; Sasaki, K.; Shirata, A.; Takasugi, M. *Phytochemistry* **1991**, *30*, 2915.
16. Pedras, M. S. C.; Zheng, Q.-A.; Sarwar, M. G. *Org. Biomol. Chem.* **2007**, *5*, 1167.
17. Pedras, M. S. C.; Sarwar, M. G.; Suchy, M.; Adio, A. M. *Phytochemistry* **2006**, *67*, 1503.
18. Monde, K.; Katsui, N.; Shirata, A.; Takasugi, M. *Chem. Lett.* **1990**, 206.
19. Pedras, M. S. C.; Zheng, Q.-A.; Gadagi, R. S. *Chem. Commun.* **2007**, 368.
20. Pedras, M. S. C.; Montaut, S.; Suchy, M. *J. Org. Chem.* **2004**, *69*, 4471.
21. Monde, K.; Taniguchi, T.; Miura, N.; Nishimura, S.-I.; Harada, N.; Dukor, R. K.; Nafie, L. A. *Tetrahedron Lett.* **2003**, *44*, 6017.
22. Putochin, N. *Ber. Deut. Chem. Ges.* **1926**, *59*, 1987.
23. (a) Schallenberg, J.; Meyer, E. Z. *Naturforsch.* **1983**, *38b*, 108. (b) Mehta, R. G.; Liu, J.; Constantinou, A.; Thomas, C. F.; Hawthorne, A.; You, M.; Gerhäuser, C.; Pezzuto, J. M.; Moon, R. C.; Moriarty, R. M. *Carcinogenesis* **1995**, *16*, 399. (c) Yamada, F.; Kobayashi, K.; Shimizu, A.; Aoki, N.; Somei, M. *Heterocycles* **1993**, *36*, 2783. (d) Csomós, P.; Fodor, I.; Sohár, P.; Bernáth, G. *Tetrahedron* **2005**, *61*, 9257.
24. (a) Monde, K.; Takasugi, M.; Ohnishi, T. *J. Am. Chem. Soc.* **1994**, *116*, 6650. (b) Pedras, M. S. C.; Okinyo, D. P. O. *Org. Biomol. Chem.* **2008**, *6*, 51.
25. (a) Acheson, R. M.; Hunt, P. G.; Littelwood, D. M.; Murrer, B. A.; Rosenberg, H. E. *J. Chem. Soc., Perkin Trans. 1* **1978**, 1117. (b) Somei, M.; Kawasaki, T. *Heterocycles* **1989**, *29*, 1251. (c) Hanley, A. B.; Parsley, K. L.; Lewis, J. A.; Fenwick, G. R. *J. Chem. Soc., Perkin Trans. 1* **1990**, 2273. (d) Kawasaki, T.; Somei, M. *Heterocycles* **1990**, *31*, 1605. (e) Pedras, M. S. C.; Zaharia, I. L. *Phytochemistry* **2000**, *55*, 213. (f) Čurillová, Z. *PhD. Thesis*, P. J. Šafárik University in Košice, **2006**. (g) Somei, M.; Kobayashi, K.; Shimizu, K.; Kawasaki, T. *Heterocycles* **1992**, *33*, 77.
26. Gaspari, P.; Banerjee, T.; Malachowski, W. P.; Muller, A. J.; Prendergast, G. C.; DuHadaway, J.; Bennett, S.; Donovan, A. M. *J. Med. Chem.* **2006**, *49*, 684.
27. (a) Somei, M.; Tanimoto, A.; Orita, H.; Yamada, F.; Ohta, T. *Heterocycles* **2001**, *54*, 425. (b) Čurillová, Z.; Kutschy, P.; Solčániová, E.; Pilátová, M.; Mojžiš, J.; Kováčik, V. *ARKIVOC* **2008**, *viii*, 85.
28. (a) Kawasaki, T.; Kodama, A.; Noshida, T.; Shimizu, K.; Somei, M. *Heterocycles* **1991**, *32*, 221. (b) Pedras, M. S. C.; Jha, M. *J. Org. Chem.* **2005**, *70*, 1828.
29. (a) Conn, W. R.; Lindwall, H. G. *J. Am. Chem. Soc.* **1936**, *58*, 1236. (b) Suchý, M.; Kutschy, P.; Monde, K.; Goto, H.; Harada, N.; Takasugi, M.; Dzurilla, M.; Balentová, E. *J. Org. Chem.* **2001**, *66*, 3940.
30. (a) Schreen, J. W.; Ooms, P. H. J.; Nivard, R. J. F. *Synthesis* **1973**, 149. (b) Hino, T.; Tsuneoka, M.; Nakagawa, M.; Akabori, S. *Chem. Pharm. Bull.* **1969**, *17*, 550. (c) Pedras, M. S. C.; Okanga, F. I. *J. Chem. Soc., Chem. Commun.* **1998**, 1565.
31. (a) Makosza, M.; Danikiewicz, W.; Wojciechowski, K. *Liebigs. Ann. Chem.* **1988**, 203. (b) Delgado, A.; Clardy, J. *J. Org. Chem.* **1993**, *58*, 2862.
32. (a) Pedras, M. S. C.; Sorensen, J. *Phytochemistry* **1998**, *49*, 1959. (b) Pedras, M. S. C.; Nycholat, C. M.; Montaut, S.; Xu, Y.; Khan, A. Q. *Phytochemistry* **2002**, *59*, 611. (c) Pedras, M. S. C.; Chumala, B.

- P.; Suchý, M. *Phytochemistry* **2003**, *64*, 949. (d) Hewawasam, P.; Meanwell, N. A. *Tetrahedron Lett.* **1994**, *35*, 7303.
33. (a) Browne, L. M.; Conn, K. L.; Ayer, W. A.; Tewari, J. P. *Tetrahedron* **1991**, *47*, 3909. (b) Jimenez, L. D.; Ayer, W. A.; Tewari, J. P. *Phytoprotection* **1997**, *78*, 99. (c) Review: Glawisching, E. *Phytochemistry* **2007**, *68*, 401. (d) Ayer, W. A.; Craw, P. A.; Ma, Y.; Miao, S. *Tetrahedron* **1992**, *48*, 2919. (e) Fürstner, A.; Ernst, A. *Tetrahedron* **1995**, *51*, 773. (f) Dzurilla, M.; Kutschy, P.; Záleťová, J.; Ružinský, M.; Kováčik, V. *Molecules* **2001**, *6*, 716.
34. (a) Devys, M.; Barbier, M.; Kollmann, A.; Rouxel, T.; Bousquet, J.-F. *Phytochemistry* **1990**, *29*, 1087. (b) Monde, K.; Tamura, K.; Takasugi, M.; Kobayashi, K.; Somei, M. *Heterocycles* **1994**, *38*, 263. (c) Gross, D.; Porzel, A.; Schmidt, J. Z. *Naturforsch., Sect. C* **1994**, *49*, 281. (d) Devys, M.; Barbier, M.; Loiselet, I.; Rouxel, T.; Sarniquet, A.; Kollmann, A.; Bousquet, J.-F. *Tetrahedron Lett.* **1988**, *29*, 6447. (e) Kutschy, P.; Suchý, M.; Monde, K.; Harada, N.; Marušková, R.; Čurillová, Z.; Dzurilla, M.; Miklošová, M.; Mezencev, R.; Mojžiš, J. *Tetrahedron Lett.* **2002**, *43*, 9489. (f) Devys, M.; Barbier, M. *Naturforsch., Sect. C* **1992**, *47*, 318.
35. (a) Suchý, M.; Kutschy, P.; Dzurilla, M.; Kováčik, V.; Andreani, A.; Alföldi, J. *Tetrahedron Lett.* **2001**, *42*, 6961. (b) Kutschy, P.; Suchý, M.; Andreani, A.; Dzurilla, M.; Kováčik, V.; Alföldi, J.; Rossi, M.; Gramatová, M. *Tetrahedron* **2002**, *58*, 9029. (c) Kutschy, P.; Čurillová, Z., unpublished results.
36. (a) Devys, M.; Barbier, M. *Synthesis* **1990**, 214. (b) Devys, M.; Barbier, M. *Org. Prep. Proced. Int.* **1993**, *25*, 344. (c) Devys, M.; Barbier, M. *Synthesis* **1990**, 214. (c) Devys, M.; Barbier, M. *Synthesis* **1990**, 214. (c) Devys, M.; Barbier, M. *J. Chem. Soc., Perkin Trans I* **1990**, 2856. (d) Pedras, M. S. C.; Okanga, F. I. *J. Chem. Soc., Chem. Commun.* **1998**, 1565. (e) Pedras, M. S. C.; Zaharia, I. *Org. Lett.* **2001**, *3*, 1231.
37. (a) Takasugi, M.; Monde, K.; Katsui, N.; Shirata, A. *Chem. Lett.* **1987**, 1631. (b) Monde, K.; Takasugi, M.; Shirata, A. *Phytochemistry*, **1995**, *39*, 581. (c) Pedras, M. S. C.; Suchý, M.; Ahiahonu, P. W. K. *Org. Biomol. Chem.* **2006**, *4*, 691. (d) Monde, K.; Osawa, S.; Harada, K.; Takasugi, M.; Suchý, M.; Kutschy, P.; Dzurilla, M.; Balentová, E. *Chem. Lett.* **2000**, 886. (e) Monde, K.; Taniguchi, T.; Miura, N.; Kutschy, P.; Čurillová, Z.; Pilátová, M.; Mojžiš, J. *Bioorg. Med. Chem.* **2005**, *13*, 5206. (f) Čurillová, Z.; Kutschy, P.; Budovská, M.; Nakahashi, H.; Monde, K. *Tetrahedron Lett.* **2007**, *48*, 8200.
38. Smith, C. J. *New Phytol.* **1996**, *132*, 1.
39. Rogers, E. E.; Glazebrook, J.; Ausubel, F. N. *Mol. Plant-Microbe Interact.* **1996**, *9*, 748.
40. (a) Boocock, D. J.; Faust, G. E.; Patel, K. R.; Schinas, A. M.; Brown, V. A.; Ducharme, M. P.; Booth, T. D.; Crowell, J. A.; Perloff, M.; Gescher, A. J.; Steward, W. P.; Brenner, D. E. *Cancer Epidemiol. Biomarkers Prev.* **2007**, *16*, 1246. (b) Kasturi, V. K.; Dearing, M. P.; Piscitelli, S. C.; Russell, E. K.; Sladek, G. G.; O'Neil, K.; Turner, G. A.; Morton, T. L.; Christian, M. C.; Johnson, B. E.; Kelley, M. J. *Clin. Cancer Res.* **1998**, *4*, 2095. (c) Lakhanpal, S.; Donehower, R. C.; Rowinsky, E. K. *Invest. New Drugs* **2001**, *19*, 69.
41. (a) Sabol, M.; Kutschy, P.; Siegfried, L.; Miroššay, A.; Suchý, M.; Hrbková, H.; Dzurilla, M.; Marušková, R.; Starková, J.; Paulíková, E. *Biologia* **2000**, *55*, 701. (b) Tempte, C.; Devys, M.; Barbier, M. *Z. Naturforsch* **1991**, *46c*, 706. (c) Mezencev, R.; Mojžiš, J.; Pilátová, M.; Kutschy, P.; Čurillová, Z. *IJCP* **2004**, *1*, 105. (d) Moody, C. J.; Roffey, J. R. A.; Stephens, M. A.; Stratford, I. J. *Anti-Cancer Drugs* **1997**, *8*, 489. (e) Oka, H.; Yoshinari, T.; Murai, T. *J. Antibiot.* **1991**, *44*, 486. (f) Csomós, P.; Zupkó, I.; Réthy, B.; Fodor, L.; Falkay, G.; Bernáth, G. *Bioorg. Med. Chem. Lett.* **2006**, *16*, 6273. (g) Pilátová, M.; Šarišský, M.; Kutschy, P.; Miroššay, A.; Mezencev, R.; Čurillová, Z.; Suchý, M.; Monde, K.; Mirossay, L.; Mojžiš, J. *Leukemia Res.* **2005**, *29*, 415. (h) Džubák, P.; Hajdúch, M.; Gažák, R.; Svobodová, A.; Psotová, J.; Walterová, D.; Sedmera, P.; Křen, P. *Bioorg. Med. Chem.* **2006**, *14*, 3793.
42. (a) Schreck, R.; Meier, B.; Männel, D. N.; Dröge, W.; Baeuerle, P. A. *J. Exp. Med.* **1992**, *175*, 1181. (b) Cvek, B.; Dvorak, Z. *Curr. Pharm. Des.* **2007**, *13*, 3155. (c) Liu, G-Y.; Frank, N.; Bartsch, H.; Lin, J-K. *Mol. Carcinog.* **1998**, *22*, 235. (d) Aragonós, J.; López-Rodríguez, C.; Corbí, A.; Gómez del Arco, P.; López-Cabrera, M.; de Landázuri, M. O.; Redondo, J. M. *J. Biol. Chem.* **1996**, *271*, 10924. (e) Wang, C-Y.; Mayo, M. W.; Baldwin, A. S. (Jr.). *Science* **1996**, *274*, 784. (f) Rahman, K. M.; Ali, S.; Aboukameel, A.; Sarkar, S. H.; Wang, Z.; Philip, P. A.; Sakr, W. A.; Raz, A. *Mol. Cancer Ther.* **2007**, *6*, 2757. (g) Montagut, C.; Rovira, A.; Albanell, J. *Clin. Transl. Oncol.* **2006**, *8*, 313. (h) Ding,

- K.; Lu, Y.; Nikolovska-Coleska, Z.; Qiu, S.; Ding, Y.; Gao, W.; Stuckey, J.; Krajewski, K.; Roller, P. P.; Tomita, Y.; Parrish, D. A.; Deschamps, J. R.; Wang, S. *J. Am. Chem. Soc.* **2005**, *127*, 10130. (i) Michael, D.; Oren, M. *Semin. Cancer Biol.* **2003**, *13*, 49.
43. (a) Telang, N. T.; Inoue, S.; Mehta, R. G.; Moriarty, R. M.; Bradlow, H. L.; Osborne, M. P. *In Vitro Cell. Dev. Biol.* **1995**, *31*, V-1009. (b) Santos, G. F.; Scott, G. K.; Lee, W. M.; Liu, E.; Benz, C. *J. Biol. Chem.* **1988**, *263*, 9565.
44. Mezencev, R.; Kutschy, P.; Salayová, A.; Čurillová, Z.; Mojžiš, J.; Pilátová, M.; McDonald, J. *Chemotherapy* **2008**, *54*, 372.
45. (a) Report of the Chemoprevention Working Group to the American Association for Cancer Research *Cancer Res.* **1999**, *59*, 4743. (b) Greenwald, P.; Nixon, D. W.; Malone, W. F.; Kelloff, G. J.; Stern, H. R.; Witkin, K. M. *Cancer (Phil)* **1990**, *65*, 1483. (c) van Poppel, G.; Verhoeven, D. T.; Verhagen, H.; Goldbohm, R., A. *Adv. Exp. Med. Biol.* **1999**, *472*, 159. (d) Talalay, P.; Fahey, J. W. *J. Nutr.* **2001**, *11 Suppl*, 3027S. (e) Mehta, R. G.; Hawthorne, M. E.; Steele, V. E. *Methods Cell Sci* **1997**, *19*, 19. (f) Mehta, R. G.; Steele, V. E.; Kelloff, C. M.; Moon, R. C. *Anticancer Res.* **1991**, *11*, 587. (g) Mehta, R. G.; Moon, R. C. *Anticancer Res.* **1991**, *11*, 593. (h) Mehta, R. G.; Liu, J.; Constantinou, A.; Hawthorne, M.; Pezzuto, J. M.; Moon, R. C.; Moriarty, R. M. *Anticancer Res.* **1994**, *14*, 1209. (i) Wattenberg, L. W. *Cancer Res.* **1985**, *45*, 1.
46. (a) Muller, A. J.; Malachowski, W. P.; Prendergast, G. C. *Expert Opin. Ther. Targets* **2005**, *9*, 831. (b) Muller, A. J.; Prendergast, G. C. *Cancer Res.* **2005**, *65*, 8065. (c) Banerjee, T.; DuHadaway, J. B.; Gaspari, P.; Sutanto-Ward, E.; Munn, D. H.; Mellor, A. L.; Malachowski, W. P.; Prendergast, G. C.; Muller, A. J. *Oncogene* **2008**, *27*, 2851.

Note added during proofs: Very recently the absolute configuration of brassicanal C [(–)-**10**] was determined as *S* by electronic circular dichroism (ECD) and vibrational circular dichroism (VCD) as published in the paper: Taniguchi, T.; Monde, K.; Nakanishi, K.; Berova, N. *Org. Biomol. Chem.* **2008**, *6*, 4399.

SYNTHESIS OF PHOSHEPINES AND APPLICATION IN ASYMMETRIC CATALYSIS

Natalia V. Dubrovina,^{*a} Ivan A. Shuklov,^b Armin Börner^{*a,b}

^aInstitut für Chemie der Universität Rostock, A.-Einstein-Str. 3a, D-18059 Rostock, Germany

(e-mail: natalia.dubrovina@uni-rostock.de; armin.boerner@catalysis.de)

^bLeibniz-Institut für Katalyse an der Universität Rostock e.V., A.-Einstein-Str. 29a, D-18059 Rostock, Germany

Abstract. Phosphepines have attracted considerable attention as ligands and organocatalysts for asymmetric transformations. An overview of synthetic venues to achiral and chiral phosphepines is presented. Recent applications of these seven-membered P-heterocycles in asymmetric catalysis are considered as well.

Contents

1. Introduction
2. General strategies for the synthesis of phosphepines
 - 2.1. Cyclization of a single component
 - 2.1.1. Thermal cyclization of arenylphosphonic acid
 - 2.1.2. Electrophilic cyclization
 - 2.1.3. Reductive coupling *via* McMurry reaction
 - 2.1.4. *Via* ring-closing metathesis
 - 2.2. Ring formation by cyclization of two components
 - 2.2.1. *Via* reaction of 1,6-dilithium salts with dichlorophosphines
 - 2.2.2. *Via* reaction of silylphosphines with acyl chloride
 - 2.2.3. *Via* radical cyclization reactions of silylphosphines with alkenes
 - 2.2.4. Nucleophilic addition reaction between 1,5-hexadiene and phosphine
 - 2.3. Ring-expansion
 - 2.3.1. From phospholes and dihydrophospholes
 - 2.3.2. From phosphinine derivatives *via* ring enlargement by a carbene unit
 - 2.4. Synthesis and modification of chiral dinaphthophosphepines
 - 2.4.1. Monodentate phosphepines
 - 2.4.2. Bidentate phosphepines
3. Asymmetric catalysis with phosphepines
 - 3.1. Asymmetric catalysis with transition metal complexes
 - 3.1.1. Asymmetric hydrogenation
 - 3.1.1.1. Monodentate phosphepines
 - 3.1.1.2. Bidentate phosphepines
 - 3.1.1.3. Asymmetric hydrogenation with self-assembling phosphepine catalyst
 - 3.1.2. Rh-catalyzed asymmetric hydroformylation
 - 3.1.3. Pd-catalyzed asymmetric allylic alkylation and amination (Tsuji-Trost reaction)
 - 3.1.3.1. Pd-catalyzed asymmetric allylic alkylation

- 3.1.3.2. Pd-catalyzed asymmetric allylic amination
- 3.1.4. Enantioselective catalytic allylation of carbonyl groups by umpolung of π -allyl palladium complexes
- 3.1.5. Pd-mediated Suzuki-Miyaura coupling
- 3.1.6. Asymmetric hydroboration
- 3.1.7. Rh-catalyzed 1,4-additions of arylboronic acids to enones
- 3.1.8. Pt-catalyzed alkoxy- and hydroxycyclization of enynes
- 3.2. Organocatalysis
 - 3.2.1. Asymmetric acylations and benzoylations
 - 3.2.2. Asymmetric [3+2] cycloadditions of imines with allenes
 - 3.2.3. Asymmetric [4+2] cycloadditions of imines with allenes

References and notes

1. Introduction

Phosphepines are unsaturated seven-membered ring heterocycles containing one phosphorous atom.¹ In contrast to saturated 7-membered ring phosphines (phosphepanes), phosphepines contain at least one double bond (**I–III**, Figure 1).

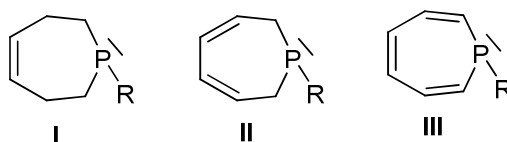

Figure 1

Due to the trivalent phosphorus, they can act as “soft” ligands and coordinate therefore preferentially to “soft” metals (HSAB-concept). Like other acyclic and cyclic phosphines, they display considerable σ -donor and π -acceptor properties and may thus significantly alter the electronic properties of a metal. This feature has been employed in metal catalyzed reaction. Moreover, appropriate substitution of the heterocycle produces chiral phosphepines, which can be applied as chiral ancillary ligands in asymmetric catalysis. Besides this application chiral phosphepines have also been used as basic organocatalysts in stereoselective transformations. In last years several efforts have been carried out to evidence the large potential of chiral phosphepines for these purposes. In this review will be give a summary about typical and recent developments and trends in the synthesis of phosphepines. Their use as ligands and organocatalysts in asymmetric catalysis will conclude the review.

2. General strategies for the synthesis of phosphepines

Synthesis of single ring phosphepines as well as benzo- and naphtho-fused derivatives can be performed in various manners. Considering general strategies in the literature, the following methodologies can be classified:

- a) Cyclization of a single component
- b) Ring formation by cyclization of two components
- c) Ring-expansion

2.1. Cyclization of a single component

2.1.1. Thermal cyclization of arenylphosphonic acids

A thermally mediated cyclodephosphonation reaction for the synthesis of arylphosphepines has been suggested by Robinson and Pettit in 1972.² They heated diphosphonic acid **1** in a sublimation apparatus for 24 hours at high temperature under vacuum (Scheme 1).

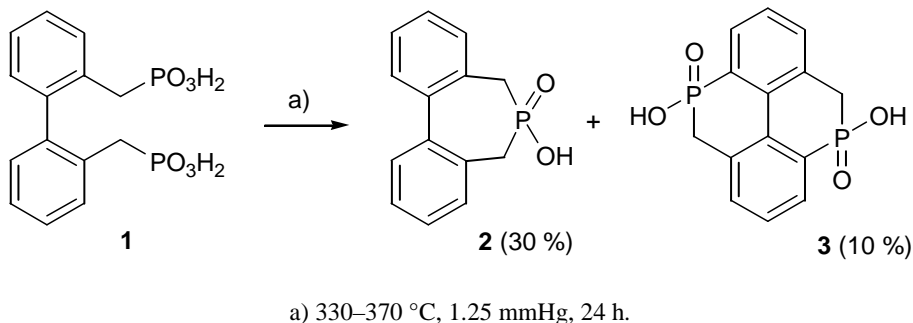

Scheme 1

The major product of this transformation is 6,7-dihydro-6-hydroxy-5H-dibenzo[*c,e*]phosphepin-6-oxide (**2**). As a side product 4,9-diphosphapyrene derivative **3** was isolated in 10% yield.

2.1.2. Electrophilic cyclizations

In 1975 a route to phosphepines *via* cyclization of alkenyl-substituted phosphonium salts in the presence of polyphosphoric acid was discovered by Dilbeck, Morris and Berlin.³ Thus, treatment of tertiary benzyl phosphines **4a,b** with allylic halides gave phosphonium salts containing a β -alkenyl substituent (Scheme 2). Benzyl diphenyl phosphine **4a** could be quaternized with allyl bromide under reflux to yield open-chain allylbenzyl diphenyl phosphonium bromide **5a**. Compound **4b** was reacted with crotyl bromide to give **5b**. The cyclization was carried out with polyphosphoric acid at high temperature for a short time to produce the phosphepines **6a,b** in yields of 24–30%.

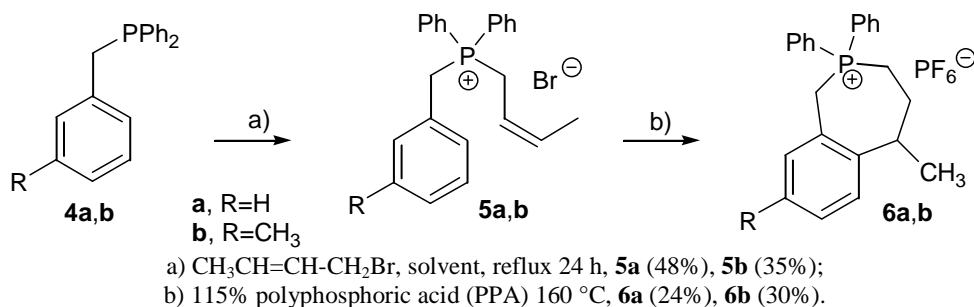

Scheme 2

In 1995 Montchamp, Frost and co-workers have developed a route to cyclic saturated phosphinic acids.⁴ The method involves a double Arbuzov reaction of bis(trimethylsiloxy)phosphine (BTSP) with dielectrophiles (Scheme 3). In detail, a mixture of 1,6-dibromohexane (**7**), BTSP (generated from ammonium hypophosphite and hexamethyldisilazane (HMDS)) was refluxed in mesitylene for several hours under argon to give phosphonium salt **8**. Under these conditions, it is converted by disproportionation into **9**. The subsequent silylation of the latter in the presence of a base generated bis(trimethylsilyl) phosphonite **10**

and proceeded faster than the competing disproportionation of **9** into the pertinent phosphine and phosphonate, respectively. Intramolecular attack of phosphorus on the second electrophilic centre in phosphonite **10** resulted in the formation of the phosphonium salt **11** underwent elimination of Me₃SiBr to give the trimethylsilylated cyclic phosphinate **12**. Hydrolysis of the latter at room temperature with aqueous NaCl afforded the corresponding cyclic phosphinic acid **13** in 58% yield.

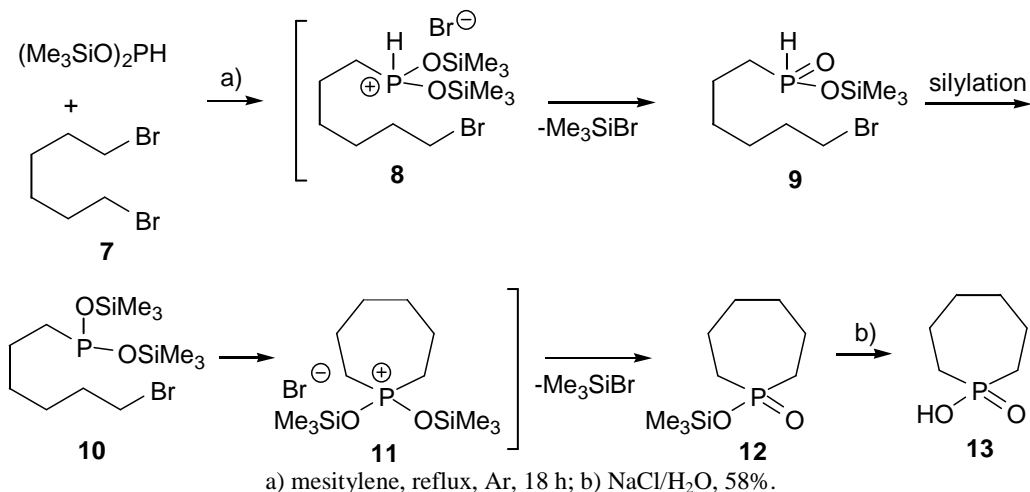

Scheme 3

2.1.3. Reductive coupling *via* McMurry reaction

The synthesis of the first stable, monocyclic phosphepine 2,7-di-*tert*-butyl-1-phenyl-1*H*-phosphepine (**17**) was demonstrated by Märkl and Burger.⁵ This seven-membered *P*-heterocycle could be prepared as depicted in Scheme 4. The intermediate bisaldehyde **16** was obtained in 20% yield by addition of bis(hydroxymethyl)phenylphosphine (**14**) to 4,4-dimethyl-2-pentynal (**15**) in acetonitrile. Intermolecular reductive coupling *via* a McMurry reaction in the presence of TiCl₃-Zn(Cu) in boiling THF gave the 2,7-di-*tert*-butyl-substituted phosphepine **17**. The compound revealed thermally stable and did not isomerize into the bicyclic analogue.

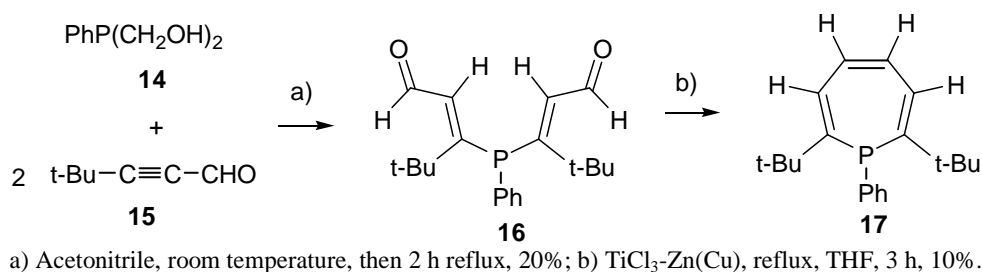

Scheme 4

2.1.4. *Via* ring-closing metathesis

A versatile method for the synthesis of phosphepines *via* ring-closing metathesis was developed by Gouverneur *et al.*⁶ Formation of seven-membered ring **20** from symmetrical diene **18** containing a phosphine-borane group required 12 mol% of the Grubbs catalyst **19** to give the product **20** in 63% yield (Scheme 5).

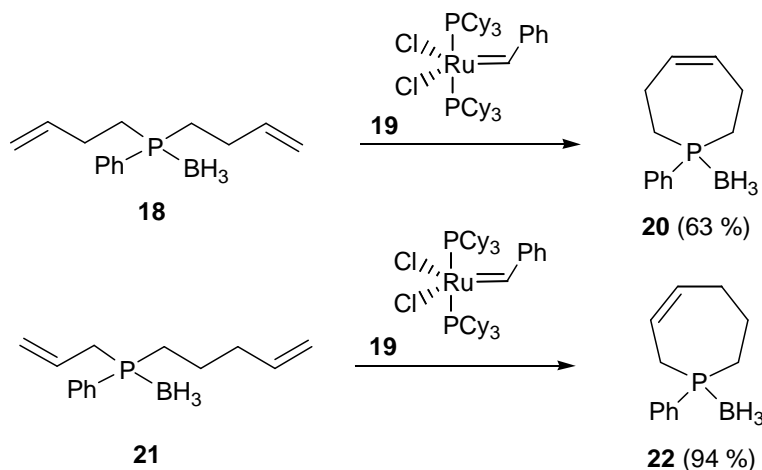

Scheme 5

Noteworthy, the isomeric seven-membered *P*-heterocycle **22** could be prepared from nonsymmetrical diene **21** in 94% yield in the presence of only 4 mol% of the Grubbs catalyst **19**.

The groups of Lammertsma⁷ and Ellman⁸ reported a similar strategy for the synthesis of tetrahydrophosphepines which in turn were used as ligands in metal complexes. As substrates for the metathesis reaction, corresponding phosphine oxides instead of borane complexes were used.

Recently, the group of Gladysz reported an advance in the synthesis of phosphepines *via* ring-closing metathesis.⁹ The starting phosphine PhP[(CH₂)₂CH=CH₂]₂ could be prepared from PPh₂, *n*-BuLi and Br(CH₂)₂CH=CH₂ and were subsequently converted into *trans*-(Cl)(C₆F₅)Pt{PPh[(CH₂)₂CH=CH₂]₂}₂ (**23**) displaying square-planar geometry (Scheme 6).

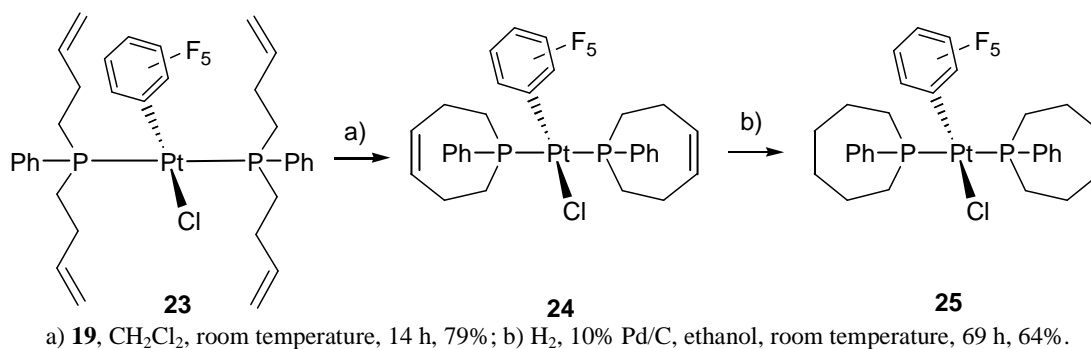

Scheme 6

Metathesis of the ligands in the coordination sphere of Pt-complex **23** mediated by Grubbs' catalyst **19** gave complex (*Z,Z*)-**24** as a main product in 86% yield. The complex could be hydrogenated to give the *trans*-complex **25**. The structure of the latter was confirmed by X-ray analysis.

2.2. Ring formation by cyclization of two components

2.2.1. *Via* reaction of 1,6-dilithium salts with dichlorophosphines

Historically the first synthesis of dibenzophosphepine was demonstrated by Mann, Millar and Smith in 1953.¹⁰ They synthesized 10,11-dihydrodibenzo[b,f]phosphepine (**27**) *via* cyclization from 2,2'-dibromodibenzyl (**26**) with *n*-butyllithium and phenyldichlorophosphine as shown in Scheme 7. Phosphepine **27** was obtained in a yield of 23% after two crystallizations.

Suggs and Freedman¹¹ and Segall *et al.*¹² used the same route for the synthesis of phosphepines **28–30** (Scheme 8). In 1993 Yasuike, Tsuchiya and co-workers reported an improved protocol.¹³

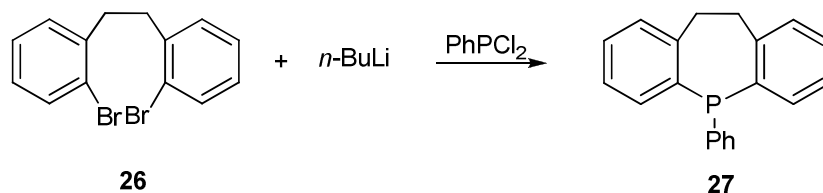

Scheme 7

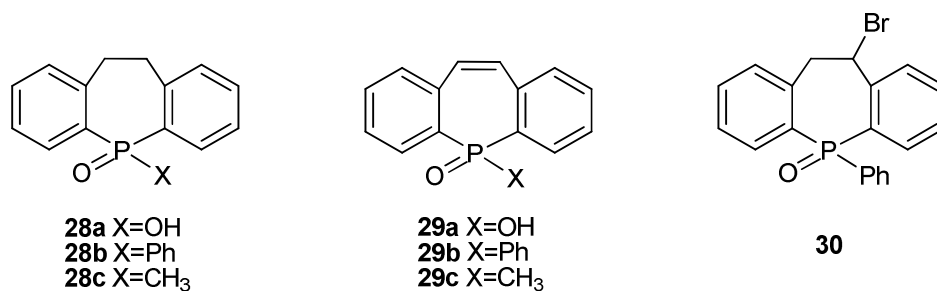

Scheme 8

The group of Tsuchiya disclosed the first general synthesis of 3-benzophosphepines according to Scheme 9.¹⁴ 1,2-Bis(2-bromovinyl)benzene (**32**) was obtained stereoselectively in high overall yield by a double Wittig reaction of *o*-phthalaldehyde (**31**) with bromomethylenetriphenylphosphorane. The product was treated with *tert*-butyllithium to give the intermediate dilithium salt, which was immediately reacted with PhPCl₂ to give the fully unsaturated phosphepine **33**.

The preparation of chiral dinaphtho[2,1-*c*;1',2'-*e*]phosphepines according to this method will be discussed separately in Section 2.4.

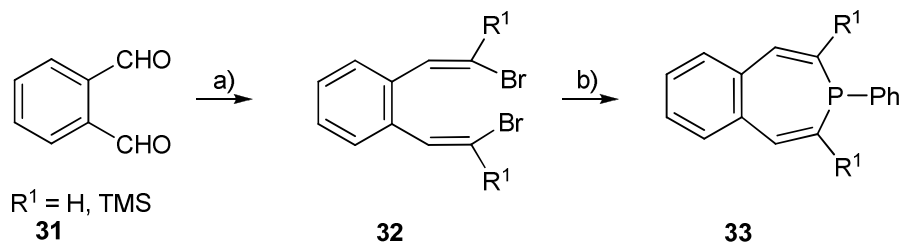

a) [Ph₃P⁺CHR¹Br] Br⁻/*t*-BuOK, THF, -80 °C, 2 h, or -80 °C to room temperature, 8 h; 90%; b) 1. *t*-BuLi, Et₂O, -80 °C, 20 min; 2. PhPCl₂, -80 °C to room temperature, 3 h, 15–40%.

Scheme 9

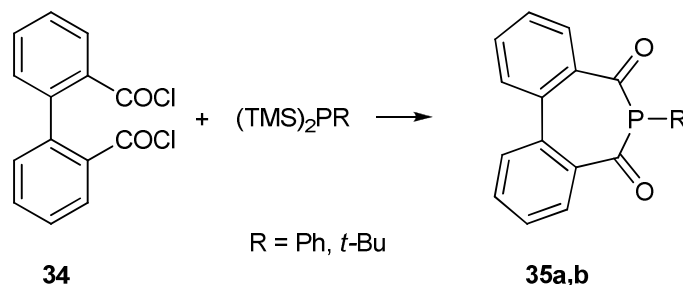

Scheme 10

2.2.2. Via reaction of silylphosphines with acyl chloride

Cowley and co-workers described the reaction of dichloride of diphenic acid **34** with bis(trimethylsilyl)phosphines as a route to dibenzophosphepine derivatives **35a,b** (Scheme 10).¹⁵

2.2.3. Via radical cyclization reactions of silylphosphines with alkenes

The radical reaction of Me_3SiPH_2 with a diolefin was examined by Schubert, Norman and co-workers.¹⁶ Thus, the cyclization of hexa-1,5-diene (**36**) with Me_3SiPH_2 in the presence of azobisisobutyronitrile (AIBN) led to the *P*-silyl-substituted phosphine **37** (Scheme 11). The acyclic dialkenylphosphine was obtained as a side-product. The target phosphepane **38** could be finally prepared after removal of the silylgroup by hydrolyzation.

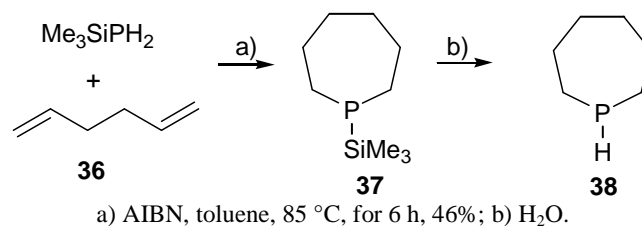

Scheme 11

2.2.4. Nucleophilic addition reaction between 1,5-hexadiene and phosphine

In 1973 Märkl und Dannhardt¹⁷ described a one-step approach to aryldihydrophosphepines **40a–c** by addition of primary arylphosphines to hexa-1,5-diyne **39a–c** as shown in Scheme 12.

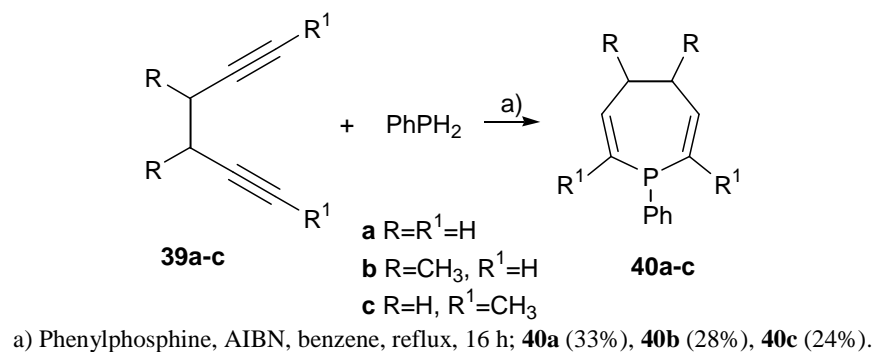

Scheme 12

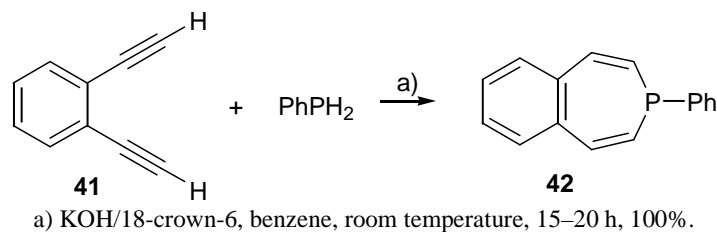

Scheme 13

Addition of phenylphosphine to 1,2-diethynylbenzene (**41**) catalyzed by KOH/18-crown-6 leads to *P*-phenylbenzophosphepine (**42**) as shown in Scheme 13.¹⁸ The desired product **42** was obtained in quantitative yield. Benzophosphepine **42** is thermolabile in decalin at 80 °C.

In 1976 Winter described the transition-metal-catalyzed cyclization of triarylphosphine oxide based bisacetylene **43** as a method for the synthesis of tribenzo[*b,d,f*]phosphepine oxide (**45**) (Scheme 14).¹⁹ As catalyst for the ring closure dichlorobis(benzonitrile)palladium or the Wilkinson's catalyst [Rh(PPh₃)₃Cl] was used. Phosphepine oxide **45** was obtained in a yield of 20%. The corresponding phosphine could be obtained by the reduction of the phosphine oxide with trichlorosilane.

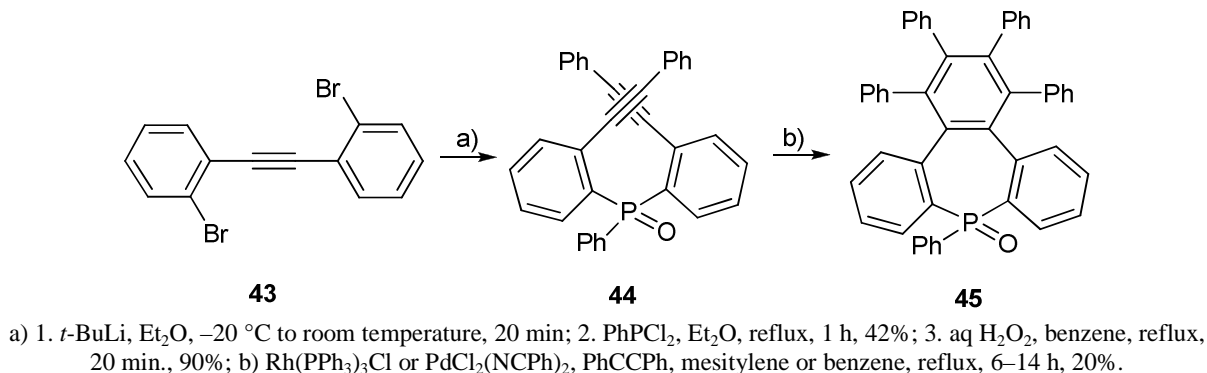

Scheme 14

Winter and Luppold reported the photolysis of phosphine **46** with Fe(CO)₅ followed by oxidation with air as a method for the preparation of dibenzophosphepine oxide **47** (Scheme 15).²⁰

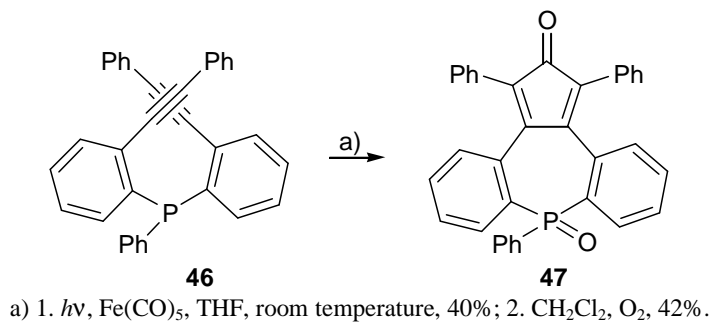

Scheme 15

2.3. Ring expansion

2.3.1. From phospholes and dihydrophospholes

In 1970, Märkl and Schubert reported the first synthesis of a phosphepine by ring enlargement starting from 1-phenyl-2,5-dihydro-1*H*-phosphole 1-oxide (**48**) (Scheme 16).²¹ The initial step involved the photochemically induced [2+2]-cycloaddition of 1-phenyl-3-phospholene 1-oxide (**48**) with dichlormaleinimide to yield both *cis*- and *trans*-adduct **49**. The *cis*-isomer of **49** was subsequently hydrolyzed with sulfuric acid and esterificated with diazomethane to give methyl ester **50**.

The dichloro-compound **50** was dehalogenized with nickel tetracarbonyl to give phosphobicyclo[3.2.0]heptene derivative **51**, which underwent thermal-catalyzed valence isomerization to afford phosphepine oxide **52**.

As an alternative method for the synthesis of unsubstituted phosphepines **57** and **59** the reductive dehalogenation of squaric acid derivative **54** was suggested (Scheme 17).²¹

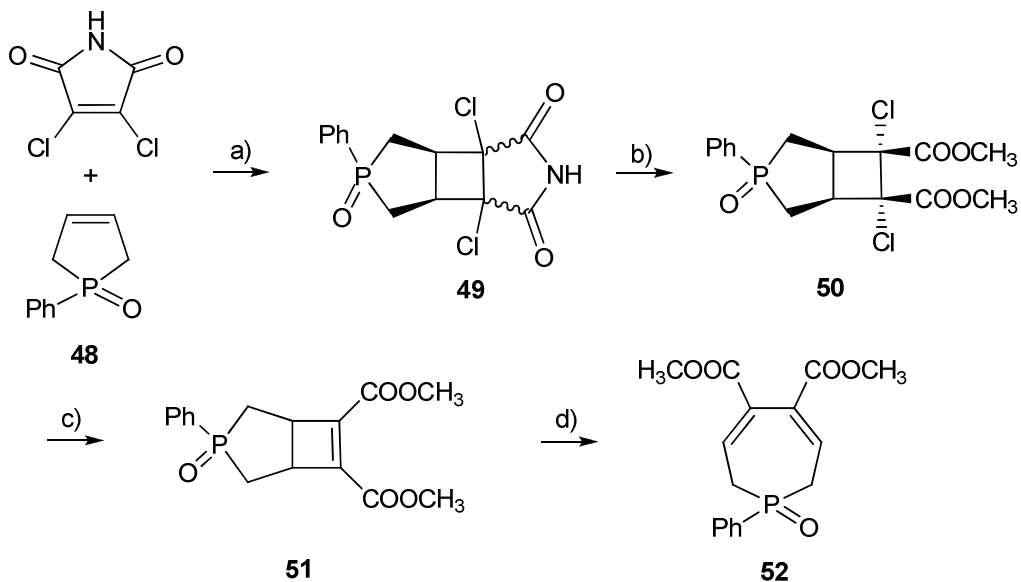

a) Irradiation (Philips HPK 125 W); b) 1. H₂SO₄, 2. CH₂N₂; c) Ni(CO)₄, benzene, reflux, 72%; d) diphenylether, reflux, 260 °C.

Scheme 16

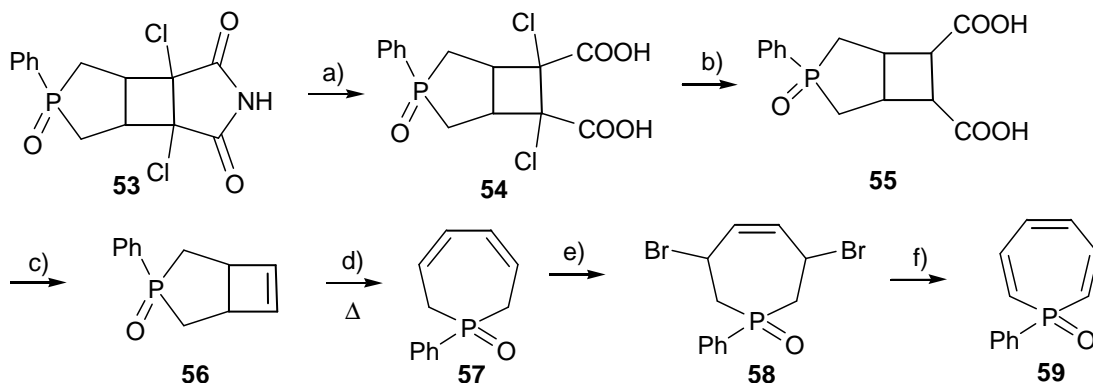

a) H₂SO₄; b) H₂/Ni-Raney, 100 °C; c) electrolysis, pyridine/H₂O, 100 V, 0.7 Amp., 64%; d) diphenylether, reflux, 260 °C, 81%; e) Br₂, 0 °C; f) Et₃N, room temperature.

Scheme 17

The resulting heterocycle **55** was transformed into phosphobicyclo[3,2,0]heptene (**56**) through an electrolysis. Phosphaporphine **57** was derived from compound **56** in 81% yields by thermal-catalyzed valence isomerization in diphenylether under reflux. It was transformed *via* a consecutive bromination and dehydrobromination step into phosphaporphine oxide **59**.

A similar approach was demonstrated by Kurita, Tsuchiya and co-workers and it is depicted in Scheme 18.²² In detail, in the first step addition of methyl acrylate to phosphindole **60** gave tricyclic compound **61**.

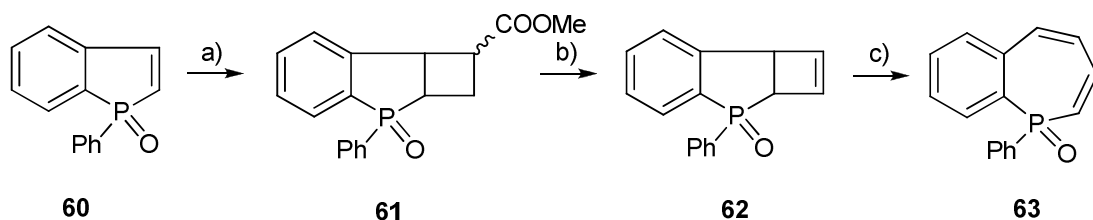

a) Methyl acrylate, benzene, irradiation (400 W, high-pressure Hg lamp), 3–4 h, 65%; b) 1. hydrolysis; 2. Pb(OAc)₄, Cu(OAc)₂, pyridine, benzene, 90–95 °C, 1.5 h, 55%; c) flash vacuum pyrolysis (6.0 x 10⁻⁵ mmHg, 550 °C), 85%.

Scheme 18

Ester **61** was first hydrolyzed and then oxidatively decarboxylated to give cyclobutene derivative **62**. Flash vacuum pyrolysis at 550 °C resulted in valence isomerization with ring-opening and afforded phosphepine oxide **63** in an overall yield of 26%. Reduction of **63** with trichlorosilane led to 1-phenylbenzophosphepine.

Quin and Middlemas used the same strategy of for the production of 3,6-dioxo-2,3,4,5,6,7-hexahydrophosphepine (**66**) (Scheme 19).²³ 1,2-Dimethylenecyclobutane (**64**) served as starting material for the McCormack cycloaddition with phosphorus(III)halides to give phosphole **65**. The latter was subjected to ring-opening ozonolysis at low temperature to give after treatment with trimethyl phosphite 3,6-dioxo-2,3,4,5,6,7-hexahydrophosphepine (**66**) in an overall yield of 90%.

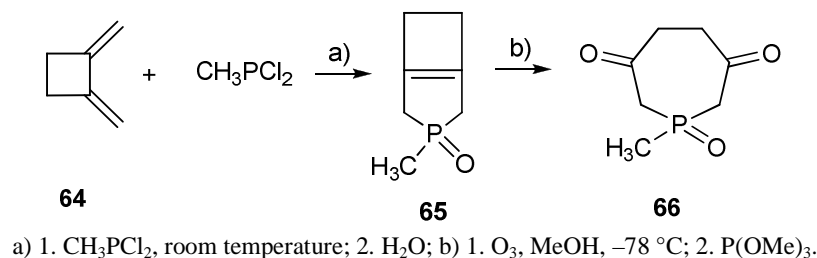

Scheme 19

The group of Mathey demonstrated a facile synthesis of metal coordinated dihydrophosphepines **69,70** starting from tungsten complex **68** as depicted in Scheme 20.²⁴ The starting material was prepared from 3,4-dimethylphosphole. Complex **68** rearranged into the chlorophosphepine W-complex **69** in the presence of AlCl_3 . After hydrolysis and treatment with methanol, dihydrophosphepine W-complex **70** was isolated in 55% overall yield.

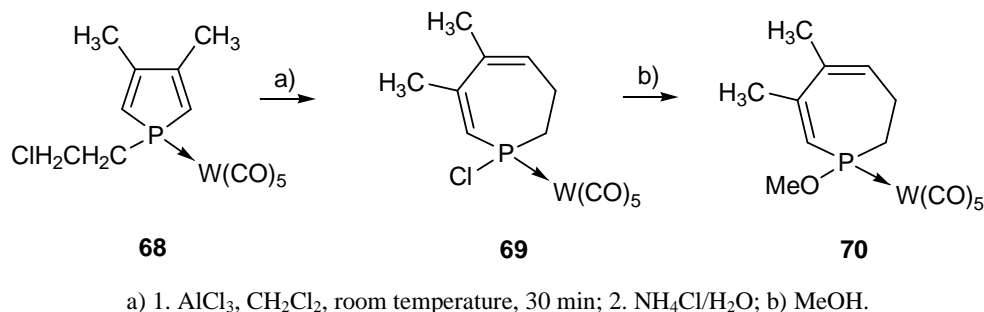

Scheme 20

2.3.2. From phosphinine derivatives *via* ring enlargement by a carbene unit

For the ring enlargement of six-membered *P*-heterocycles (phosphinines) into seven-membered heterocycles (phosphepine) in the literature two main methods can be identified: a) synthesis *via* ring enlargement by addition of a carbene unit and b) valence isomerization between 1-phosphanorcaradienes and 1-phospha-2*H*-tropylienes (2*H*-phosphepines).

In 1987 Märkl *et al.* synthesized dihydrophosphepine **73** *via* addition of diphenylcarbene to the P-C double bond of diphenylphosphabenzene (**71**) to give the fused bicyclic compound **72** (Scheme 21).²⁵ The targeted seven-membered *P*-heterocycle **73** was obtained by ring opening of the phosphocyclopropane ring in **72** with hydrogen chloride in almost quantitative yield.

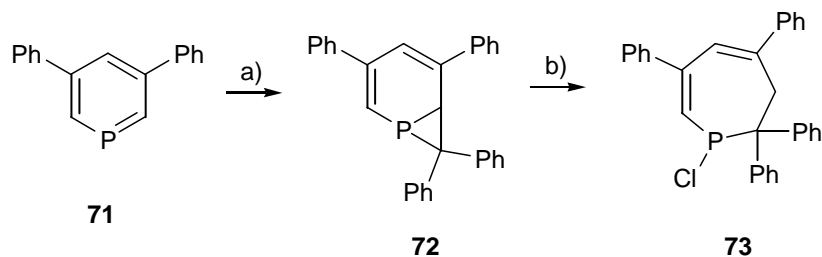

a) Diphenyldiazomethane (Ph_2CN_2); b) HCl, 98%.

Scheme 21

The reaction of the pentacarbonyl complex of phosphinine **75** with diazomethane or monosubstituted diazomethanes led to the metal carbonyl complexes of the type **74** (Scheme 22).²⁵ In contrast, **75** reacts with diphenyldiazomethane to give 1-phosphanorcaradiene complexes **76**.

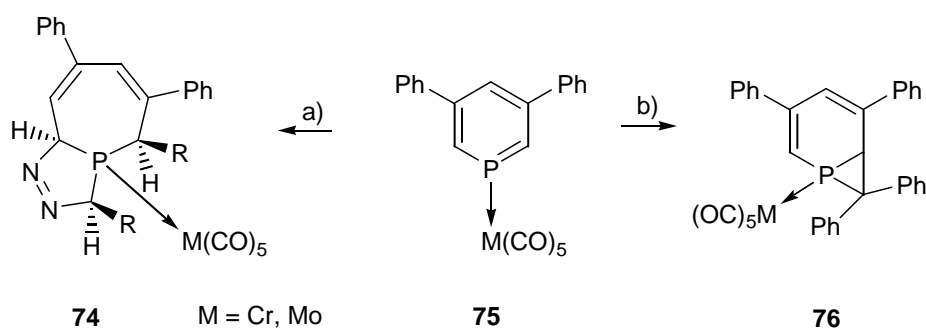

M = Cr, Mo
a) RCHN_2 or CH_2N_2 ; b) Ph_2CN_2 , **76a** (61%), **76b** (87%).

Scheme 22

The same research group described for the first time valence isomerization between 1-phosphanorcaradienes **77** and 2*H*-phosphepines **79**.²⁵ Compound **78** could be quantitatively reconverted into phosphine **77** by a base induced dehydrochlorination reaction (Scheme 23).

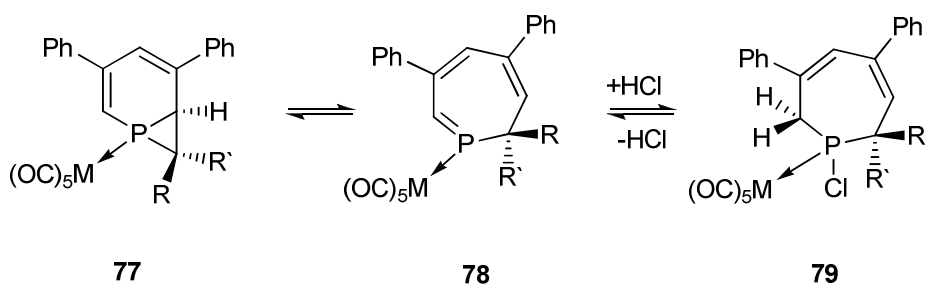

Scheme 23

Keglevich and co-workers described the reaction of the isomeric dienes **80** with dichlorocarbene.²⁶ Under the applied reactions conditions the intermediates **81** underwent cyclopropane ring opening to give the single phosphepine oxide **82** (Scheme 24).

The yield of the desired seven-membered heterocycles **82** was low due to the subsequent polymerization. The highest yield reached only 15% ($Y=n\text{-Bu}$). This method was also employed for the synthesis of related phosphepines.²⁷

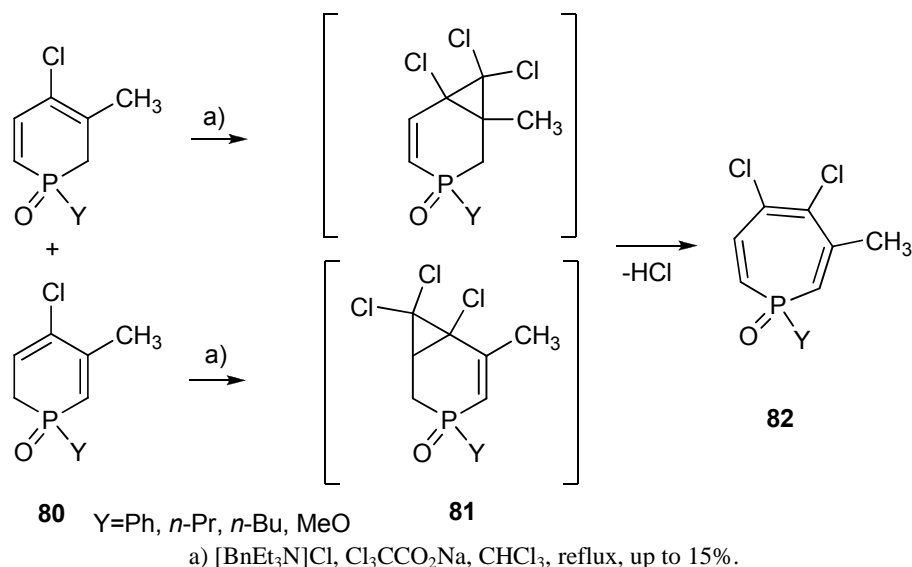

Scheme 24

2.4. Synthesis and modification of chiral dinaphthophosphepines

2.4.1. Monodentate phosphepine

This section covers the synthesis and modifications of chiral dinaphtho[2,1-*c*;1',2'-*e*]phosphepines, which are the most studied class of arylfused phosphepines up to now. All hitherto known dinaphtho[2,1-*c*;1',2'-*e*]phosphepine derivatives were synthesized by ring formation from two components: binaphthyl derivative (C6-synthon) that provides six-atoms to the final phosphepine ring and a P1-synthon.

In 1994 the Gladiali group described the synthesis of chiral 4-phenyl-4,5-dihydro-3*H*-dinaphtho[2,1-*c*;1',2'-*e*]phosphepine (**84**) starting from 2,2'-dimethyl-1,1'-dinaphthyl (**83**) (Scheme 25).²⁸

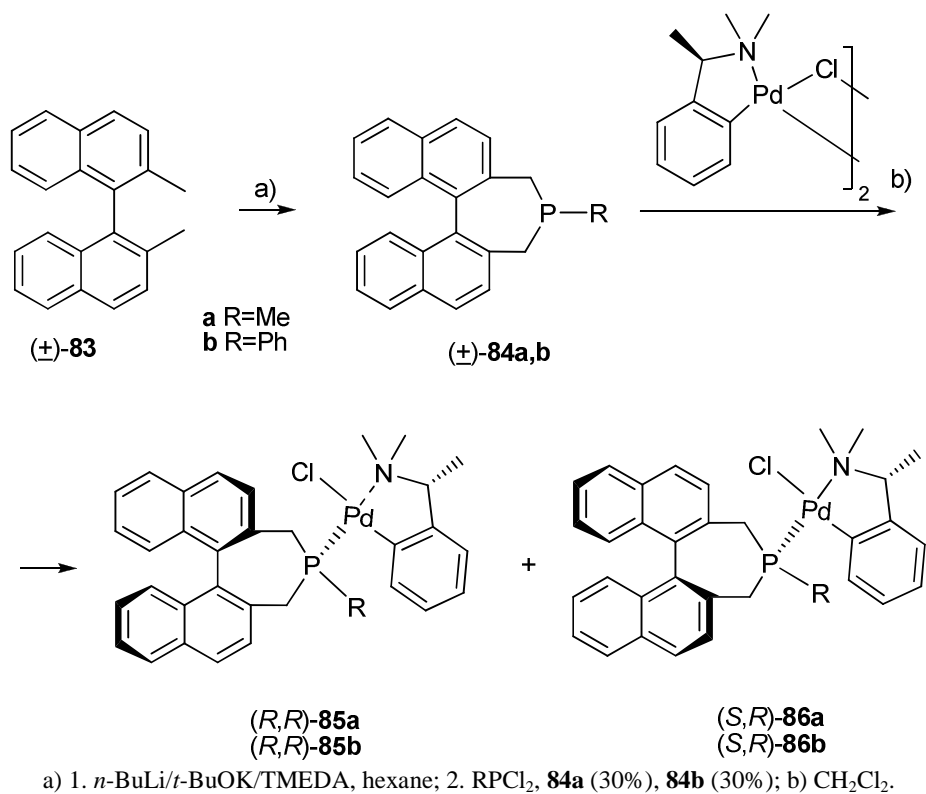

Scheme 25

The starting compound **83** was prepared from 1-bromo-2-methylnaphthalene by aryl-aryl coupling of 1-bromo-2-methylnaphthalene with its Grignard reagent in the presence of a catalytic amount of bis(triphenylphosphine)dichloro-nickel.²⁹ Metallation of **83** with *n*-BuLi/*t*-BuOK/TMEDA afforded the pertinent Li-salt which was quenched with *P*-substituted dichlorophosphines. The resulted phosphepines **84a,b** were obtained in yields of 30%. Resolution of the racemic compounds **84a,b** was accomplished by means of an ortho-metallated enantiopure palladium amine complex.³⁰ The resultant diastereomeric Pd-complexes **85** and **86** were recrystallized to give the less soluble and diastereomerically pure isomers **85a** and **85b**. Finally enantiopure phosphepines were liberated by treatment of Pd-complexes **85a,b** with 1,2-bis(diphenylphosphino)ethane.

In 1998 Stelzer and co-workers³¹ reported the first synthesis of the secondary racemic phosphepine **88**. It has been obtained in a yield of 75% by phosphination of 2,2'-bis(halomethyl)-1,1'-binaphthyl with PH₃ in aprotic dipolar solvents such as dimethyl sulfoxide (DMSO) as shown in Scheme 26.

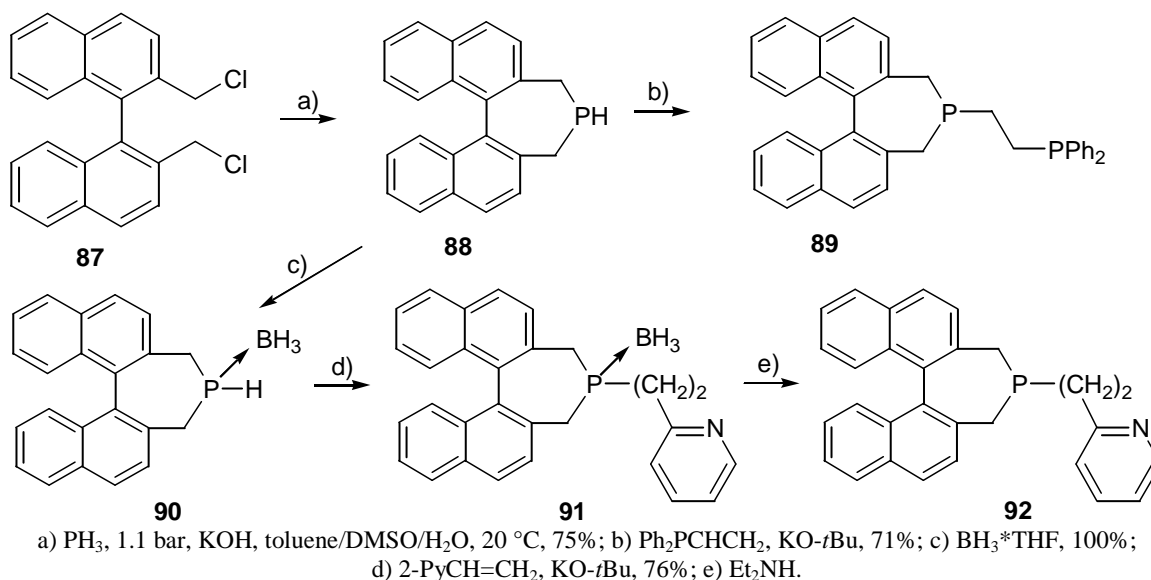

Scheme 26

As a base a concentrated potassium hydroxide solution was found to be advantageous. In the ³¹P{¹H} NMR spectrum, **88** exhibits a singlet in a range typically found for secondary phosphines at δ=−30.6. Compound **91** (δ=48.7 ppm) was prepared by addition of 2-vinylpyridine to the secondary phosphine borane adduct **90**. Upon treatment with Et₂NH the unprotected phosphepine **92** was obtained. Compared with **88**, the ³¹P{¹H} NMR signals of its borane complex **90** (δ=19.2 ppm) is shifted downfield by ca. 50 ppm. The secondary phosphepine **88** or its borane adduct **90** are of special interest as starting material and building blocks for the synthesis of functionalized and bidentate ligands due the reactivity of the PH function. Thus, for example alkylation gives mixed diphosphine **89**.

Coupling of the borane adduct of **94** with 2,2'-bromomethyl-1,1'-binaphthyl (**93**) leads to the borane complex **95** containing three units of axial asymmetry (Scheme 27).³¹ The ³¹P{¹H} NMR spectrum of bisphosphepine **95** showed four signals (δ=50.9, 50.1, 49.7 and 49.2 ppm, in C₆D₆), two of them being of about equal intensity (δ=50.1 and 49.2 ppm). Liberation of **95** with NEt₂H gave the racemic phosphepine characterized in the ³¹P{¹H} spectrum by resonances at δ 10.9, 10.0, 8.8, and 8.7.

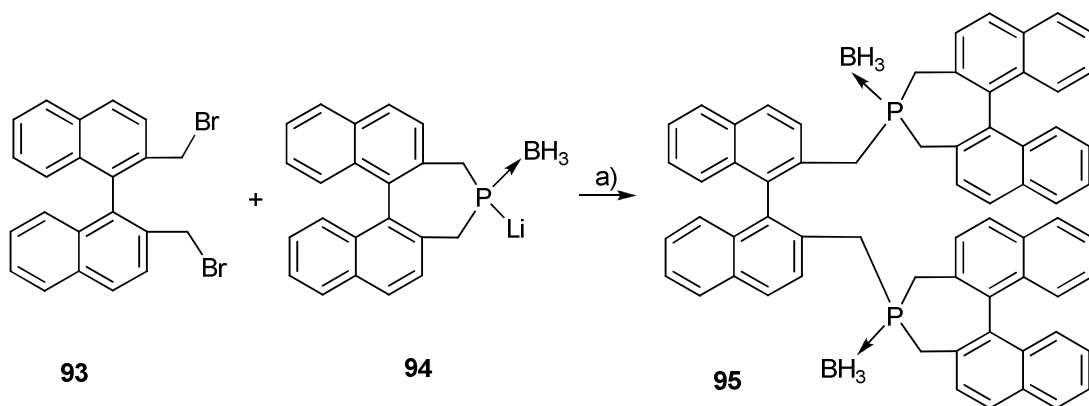

a) *n*-BuLi, $-78\text{ }^{\circ}\text{C}$, THF, 2 h, 66%.

Scheme 27

The lithium salt **94** was also used as building block for the preparation of bisphosphines **96–99** (Scheme 28). Thus, coupling of the borane adduct **94** with α,ω -dihalogen compounds gave the products in moderate to good yields (48–86%).³¹

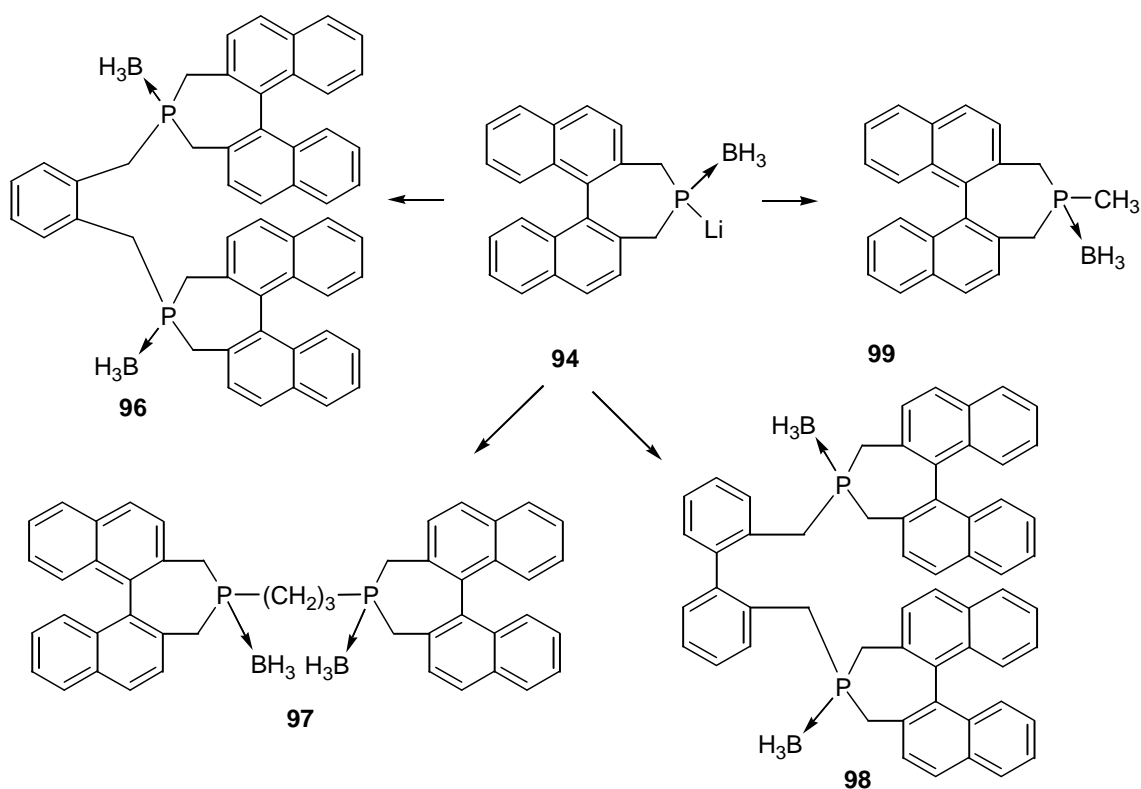

Scheme 28

The BH_3 groups in borane adducts **96–99** could be removed by heating with an excess of diethylamine at $50\text{ }^{\circ}\text{C}$ for 8 h. The products were characterized by NMR spectroscopy, mass spectrometry and noteworthy also by X-ray structural analysis.

Schmutzler and co-workers used 4,4-di-*tert*-butyl-4,5-dihydro-3*H*-dinaphtho[2,1-*c*;1',2'-*e*] phosphepinium bromide (**100**) as starting material for the synthesis of *P*-unsymmetrically substituted derivatives of NAPHOS (**101**) representing a widely used ligand in homogeneous catalysis (Scheme 29).³²

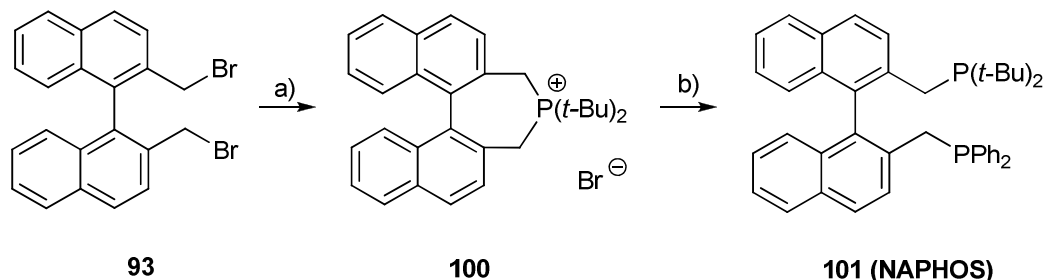

a) *t*-Bu₂PH, toluene, reflux for 8 h, 66%; b) KPh₂, DMF, room temperature, 24 h, 66%.

Scheme 29

The synthesis of the key compound 4,4-di-*tert*-butyl-4,5-dihydro-3*H*-dinaphtho[2,1-*c*:1',2'-*e*]phosphepinium bromide (**100**) was achieved starting from dibromide **93**, which was reacted with di-*tert*-butylphosphine. It was characterized by NMR, mass spectrometry and X-ray crystallography. Treatment of the salt with KPh₂ afforded NAPHOS.

Alternatively to the approach of Gladiali *et al.*, Zhang and co-workers developed a practical route to the chiral phosphepine **104a** based upon readily accessible enantiopure (*R*)-2,2'-dimethyl-1,1'-dinaphthyl [(*R*)-BINOL, **102**] as a starting material (Scheme 30).³³

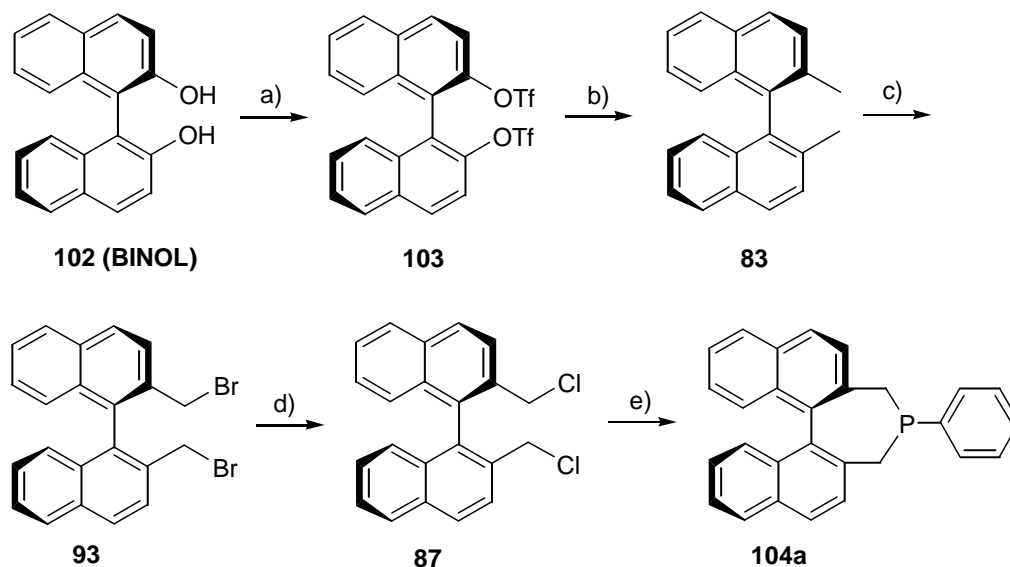

a) Tf₂O, pyridine, CH₂Cl₂, 99%; b) MeMgBr, NiCl₂(dppp), Et₂O, 99%; c) NBS, benzoyl peroxide, CCl₄, 69%;
d) LiCl, DMF, 93%; e) C₆H₅PH₂, NaH, THF, 90%.

Scheme 30

(*R*)-1,1'-Binaphthyl-2,2'-bistriflate (**103**) was prepared from (*R*)-BINOL (**102**) with an excess of triflic anhydride in pyridine. In turn the triflate was converted into 2,2'-dimethyl-1,1'-binaphthyl (**83**) via nickel-catalysed Kumada coupling with methylmagnesium bromide in high yield (99%). Radical bromination of **83** with *N*-bromosuccinimide (NBS) gave bromide **93**. Halogen exchange with LiCl afforded enantiopure (*R*)-2,2'-dichloromethyl-1,1'-binaphthyl (**87**) in 93% yield. Ring closure to **104a** was achieved by refluxing **87** with phenylphosphine and NaH.

The groups of Beller³⁴ and Zhang³⁵ developed a related pathway for preparing monodentate chiral phosphorus ligands **104a-f** as shown in Scheme 31.

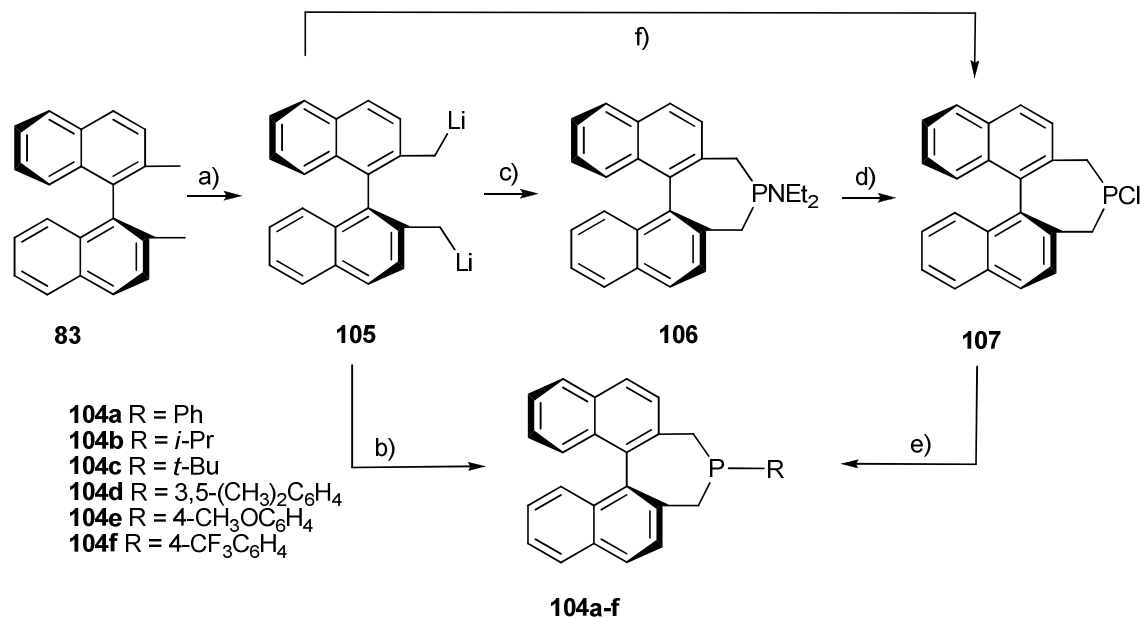

a) *n*-BuLi/TMEDA, Et₂O, -78 °C to room temperature, 60%; b) RPCl₂, hexane, 0 °C then reflux 2 h; c) Et₂NPCl₂, hexane, 0 °C then reflux 2 h; d) HCl, 80%; e) RMgBr, THF, reflux 2 h; f) hexane, PCl₃, 40%.

Scheme 31

Based on (*S*)-2,2'-dimethyl-1,1'-binaphthyl (**83**), a large set of chiral monodentate phosphorus ligands used in asymmetric catalysis could be derived. In one approach, double metallation of **83** with *n*-butyl lithium/TMEDA (tetramethylethylenediamine) and quenching with corresponding dichlorophosphines gave phosphepines **104a–d** in yields of 60–83%.

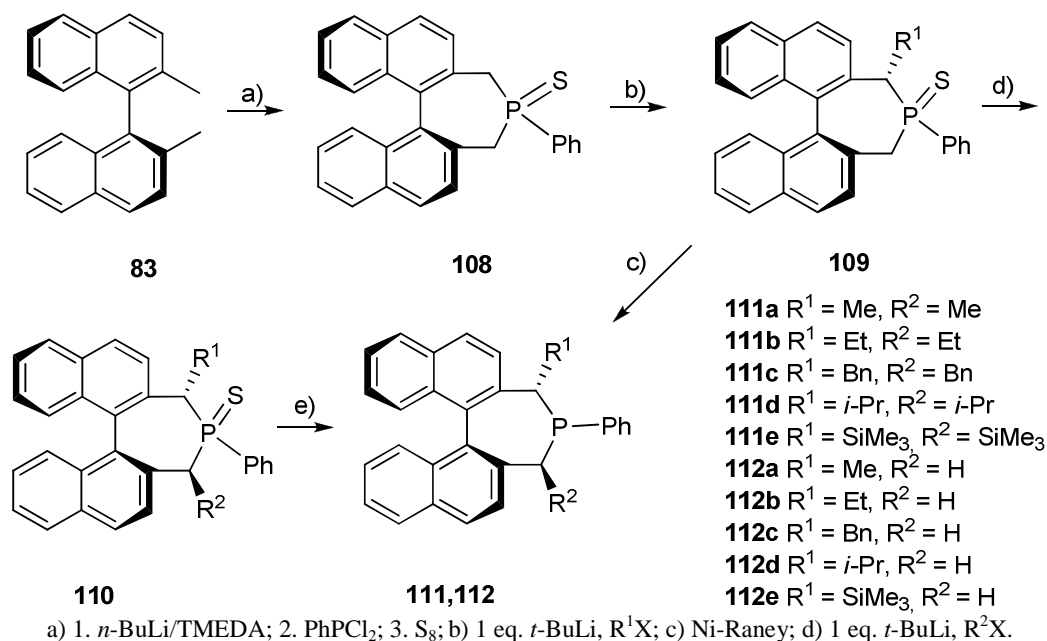

Scheme 32

The second approach was based on the double metallation of **83**, quenching with Et₂NPCl₂ and subsequent reaction with HCl (Beller) or direct quenching of dilithium salt with PCl₃ (Zhang) to give 4-chloro-4,5-dihydro-3*H*-dinaphtho[2,1-*c*;1',2'-*e*]phosphepine (**107**). The chloro derivate was used as

starting material in subsequent Grignard reactions with RMgBr. The desired phosphepines **104a–f** were isolated in 62–76% yield. The Beller group used this pathway also for the preparation of substituted 4,5-dihydro-3*H*-dinaphtho[2,1-*c*:1',2'-*e*]phosphepine ligands.³⁶

Widhalm and co-workers synthesized α -substituted phosphepines (Scheme 32).³⁷ Again (*S*)-2,2'-dimethylbinaphthyl (**83**) was used as starting compound. It was first converted into phosphepine sulphide **108**. This compound was stereoselectively deprotonated and then alkylated to give the asymmetrical and symmetrical, mono- and bis- α,α' -substituted phosphepines **111** and **112**. Raney nickel has been employed as a reducing agent for the removal of the sulfur.

Recently, the group of Beller utilized a similar approach to the synthesis of phosphepine **111a**, but employing phosphepine oxide **113** instead of the sulfide **108** to obtain finally (*S,S*,*Sp*)-3,5-dimethyl-4-phenyl-4,5-dihydro-3*H*-dinaphtho[2,1-*c*:1',2'-*e*] phosphepine (**111a**) (Scheme 33).³⁸

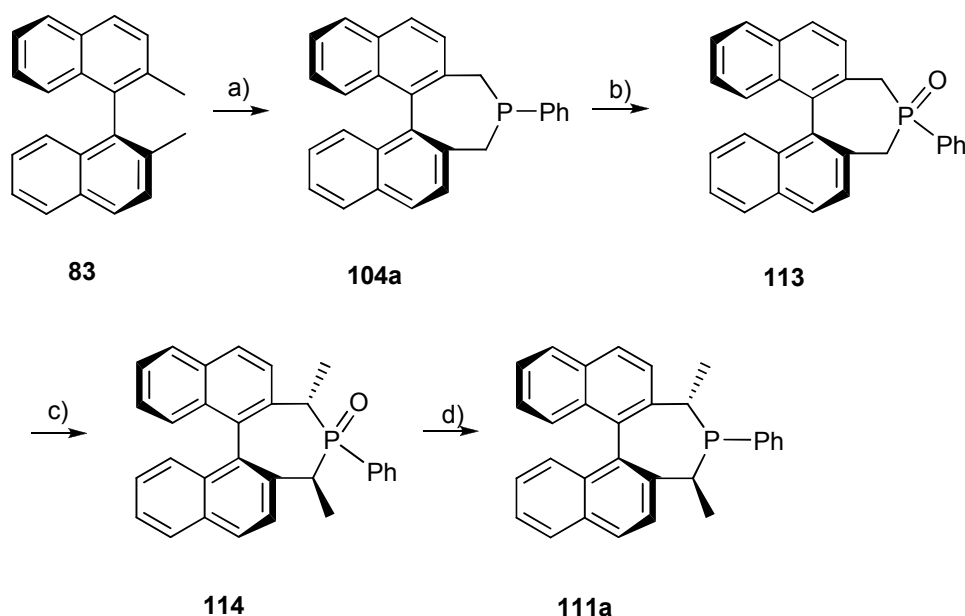

a) 1. *n*-BuLi/TMEDA; 2. RPCl_2 ; or 1. *n*-BuLi/TMEDA; 2. Et_2NPCl_2 ; 3. HCl, 4. PhMgX or PhLi ; b) H_2O_2 ; c) LDA/MeI; d) HSiCl_3 .

Scheme 33

Main steps are the oxidation of phosphepine **104a** with H_2O_2 followed by deprotonation and alkylation with CH_3I (2 equiv) at room temperature. The reaction is completely stereoselective and only one of four possible dialkylated products was obtained. Detailed NMR-studies confirmed the formation of exclusively one stereoisomer. Racemization of the binaphthyl backbone in the course of reactions was excluded too.

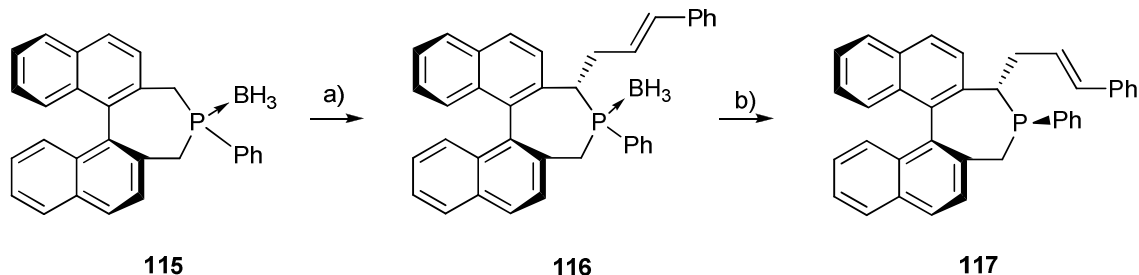

a) *n*-BuLi/TMEDA, 2. PhPCl_2 ; 3. $\text{BH}_3 \cdot \text{THF}$; b) 1. *n*-BuLi, $\text{PhCHCHCH}_2\text{Br}$, 2. $\text{Et}_2\text{NH/THF}$.

Scheme 34

In this connectivity, Widhalm and co-workers developed a synthetic route to an unsymmetrically α -substituted phosphine (Scheme 34).³⁹ The phosphine **117** bearing a side arm with an olefin functionality was prepared starting from the borane complex of (*S*)-4-phenyl-4,5-dihydro-3*H*-dinaphtho[2,1-*c*:1',2'-*e*] (**115**) *via* stereoselective deprotonation with *n*-BuLi, followed by treatment with cinnamyl bromide. The borane group was removed by treatment with Et₂NH to give (*S,S_a,S_p*)-**117** in 61%.

2.4.2. Bidentate phosphine

In 1999, Zhang and co-workers reported a route to bisphosphine **118** based on enantiopure (*R*)-BINOL (**102**) as a starting material (Scheme 35).³³

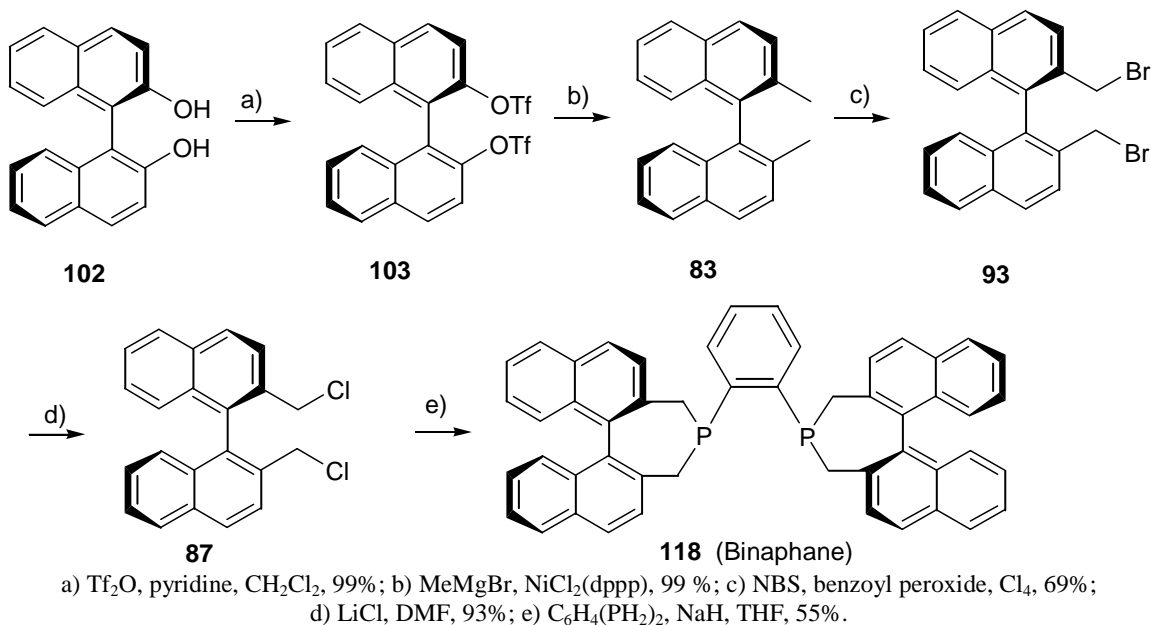

Scheme 35

As already described in Scheme 30, esterification of the diol with Tf₂O gives the corresponding bistriflate **103**. Kumada-coupling with MeMgBr furnished 2,2'-dimethyl-1,1'-binaphthyl (**83**) in quantitative yield. The dibromide **93** was obtained by radical bromination of **63**. Conversion into the dichloride **87** was achieved *via* halogen exchange with LiCl in a yield of 93%. By using NaH as a base, condensation of (*R*)-2,2'-dichloromethyl-1,1'-binaphthyl (**87**) with 1,2-bis(phosphino)benzene yielded Binaphane **118** in a yield of 55%.

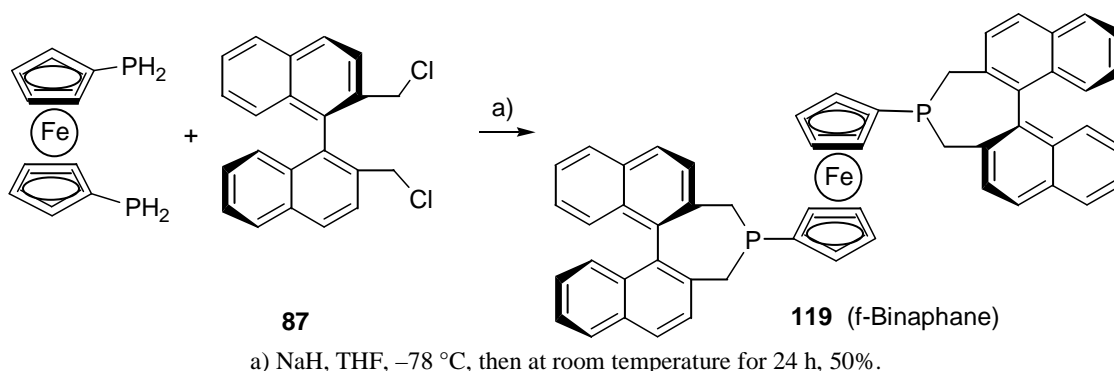

Scheme 36

In a similar approach, the same group disclosed the synthesis of the air-stable, chiral 1,1'-bis-phosphinoferrrocene (**119**; abbreviated as f-Binaphane) (Scheme 36).⁴⁰

Parallel to this work the group of Moberg reported on the synthesis of phosphepine **123** (Scheme 37).⁴¹ The compound contains two different units: 4,5-dihydro-3*H*-dinaphtho[1,2-*c*:2',1'-*e*]azepine and 4,5-dihydro-3*H*-dinaphtho[1,2-*c*:2',1'-*e*]phosphepine. It may therefore serve in organometallic chemistry as a mixed bidentate ligand. In the initial step, amino-phosphonate **120** was synthesized *via* reaction of (*S*)-2,2'-di(bromomethyl)-1,1'-binaphthyl **93** with (2-aminoethyl)-phosphonic acid diethyl ester in the presence of triethylamine. The reduction of amino-phosphonate **120** with LiAlH₄ followed by treatment with BH₃*SMe₂ gave the borane protected aminophosphine **121**. By using NaH as a base, the condensation of (*S*)-**93** with aminophosphine yielded “*pseudo-C*₂” (*S,S*)-**122** in 76%. Aminophosphine **123** was obtained finally by reaction with DABCO. By application of (*R*)-2,2'-dibromomethyl-1,1'-binaphthyl (**93**), the corresponding diastereomeric “*pseudo-meso*” P,N-ligands (*R,S*)-**122** and (*R,S*)-**123**, respectively, were available.

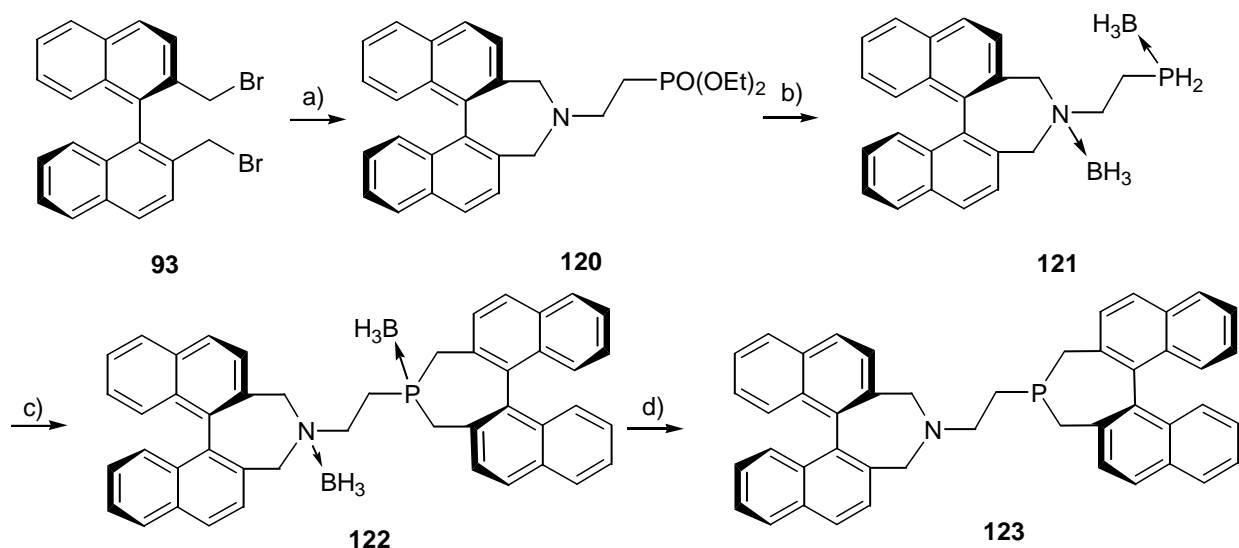

a) NH₂CH₂CH₂PO(OEt)₂, NEt₃, THF, 94%; b) 1. LiAlH₄, THF, 91%; 2. BH₃*SMe₂, THF, 99%; c) (*S*)-**93** or (*R*)-**93**, NaH, 76%; d) DABCO, CH₂Cl₂, 96%.

Scheme 37

Recently, the same group published in a similar approach the synthesis of a related N,P-hybrid, where the *N*-unit is part of a configurationally labile binaphthyl backbone (Scheme 38).⁴²

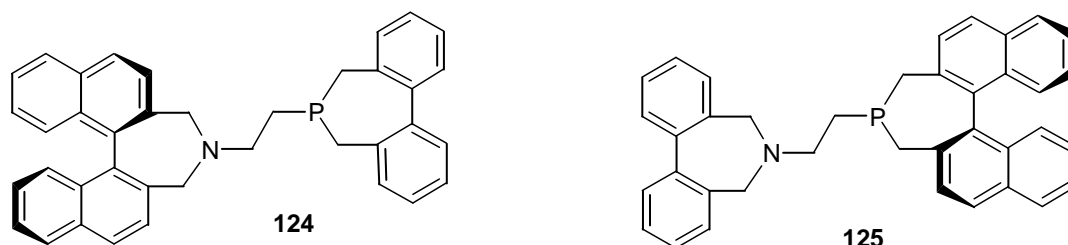

Scheme 38

A 3,3'-disubstituted bisphosphepine was generated by Zhang in 2002 (Scheme 39).³⁵ In key steps 2,2'-dimethyl-1,1'-binaphthyl was lithiated with 2.5 equiv. of *n*-butyllithium in ether to give dilithium salts

(*S*)-**126a,b** as a red powder in 60% yield.⁴³ Double nucleophilic substitution of the latter with 1,2-bis-(dichlorophosphine)ethane furnished the desired potentially bidentate ligand **127a,b**.

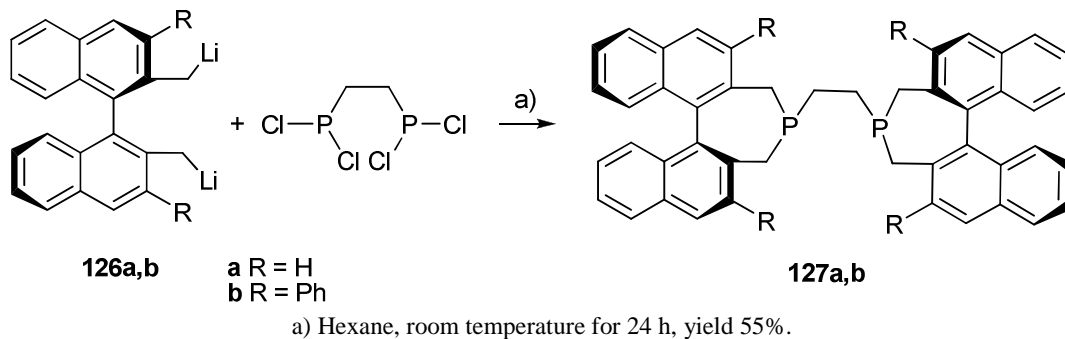

Scheme 39

In 2003, the same research group designed the more rigid bisphosphepine **130** displaying besides atropisomery additionally two stereogenic phosphorus centres (Scheme 40).⁴⁴ Double metallation of enantiomerically pure (*S*)-**83** with *n*-BuLi/TMEDA led to the dilithium salt **105**. It was reacted with *t*-BuPCl₂ and sulfur in order to get the phosphine sulfide **128**. Deprotonation of **128** with *t*-BuLi/TMEDA in HMPA (hexamethyl phosphoramide)/THF, followed by Cu-mediated coupling, led to the phosphinesulfide **129** as a single isomer.

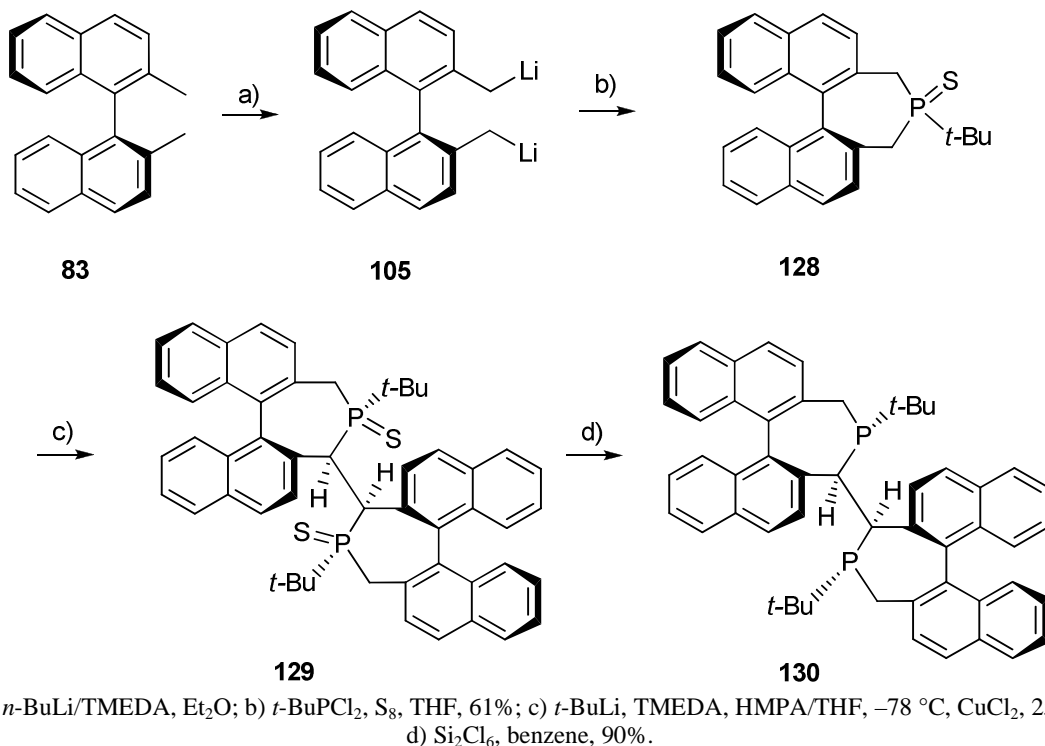

Scheme 40

Worthy of note is that non-converted starting material **128** could be recovered in 50% yield. The absolute configuration of **129** was confirmed by its X-ray crystallography. The free phosphepine **130** was obtained by desulfurization of **129** with hexachlorodisilane.

The bidentate phosphepine **131** as a diastereomeric mixture was already described by the group of Stelzer in 1998.³¹ Ten years later, Junge and Beller reported the synthesis of this compound in enantiopure form according to Scheme 41. As starting material served dilithium salt **105** again which was generated from (*S*)-**83** as shown above. The salt was quenched with chlorophosphepine **107** to give bisphosphepine **131** in a yield of 70%. The potentially bidentate ligand was prepared in both diastereomeric forms [(*S,S,S*) and (*S,R,S*)] in order to identify in asymmetric catalysis matched and mismatched correlations.

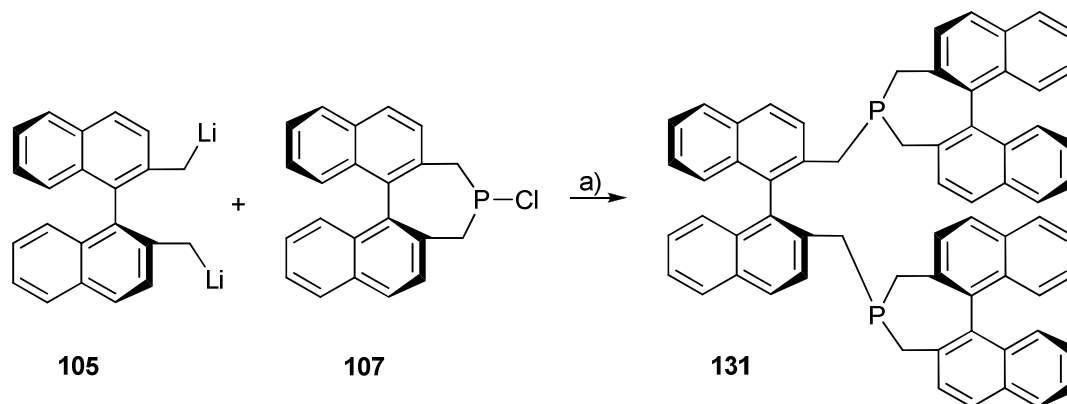

a) Toluene, stirring for 10 h at room temperature, 70%.

Scheme 41

A similar approach was employed for the synthesis of the trisbinaphthyl-derived bisphosphinite **132** (Scheme 42).⁴⁵ The compound was synthesized straightforward in fair yield by reaction of chlorophosphepine **107** with enantiopure BINOL (**102**) in the presence of triethylamine. Both diastereomers (*S,S,S*) and (*S,R,S*) were prepared based on this protocol. Crude **132** was purified by recrystallization of its rhodium complex.

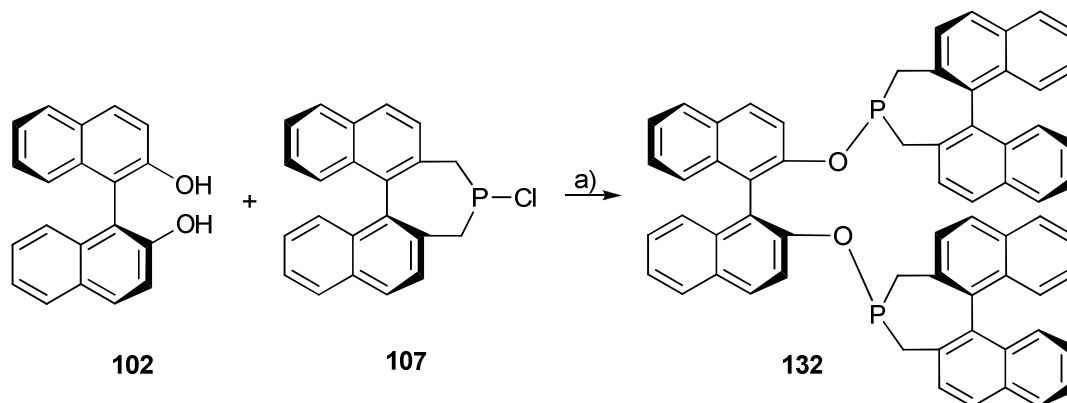

a) Et₃N, toluene, 0 °C, then stirring for 2 h at room temperature, 81%.

Scheme 42

A mixed phosphine-phosphinite was generated from the already mentioned compound **107** and (*S*)-(-)-2-(diphenylphosphino)-2'-hydroxy-1,1'-binaphthyl⁴⁶ (**133**) (Scheme 43).⁴⁷ The condensation was carried out in toluene at reflux in the presence of triethylamine as a base to remove HCl.

Recently, we reported an example of a phosphepine bearing a 2-pyridone unit in the backbone (Scheme 44).⁴⁸ As a starting material enantiopure (*S*)- or (*R*)-BINOL (**102**) was used.

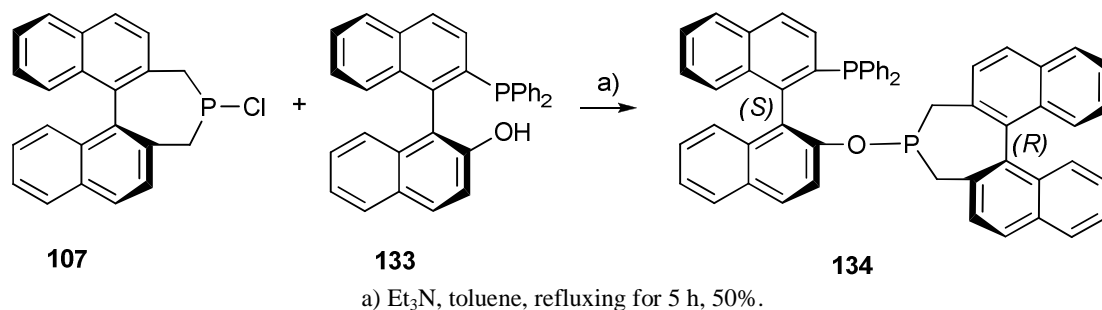

Scheme 43

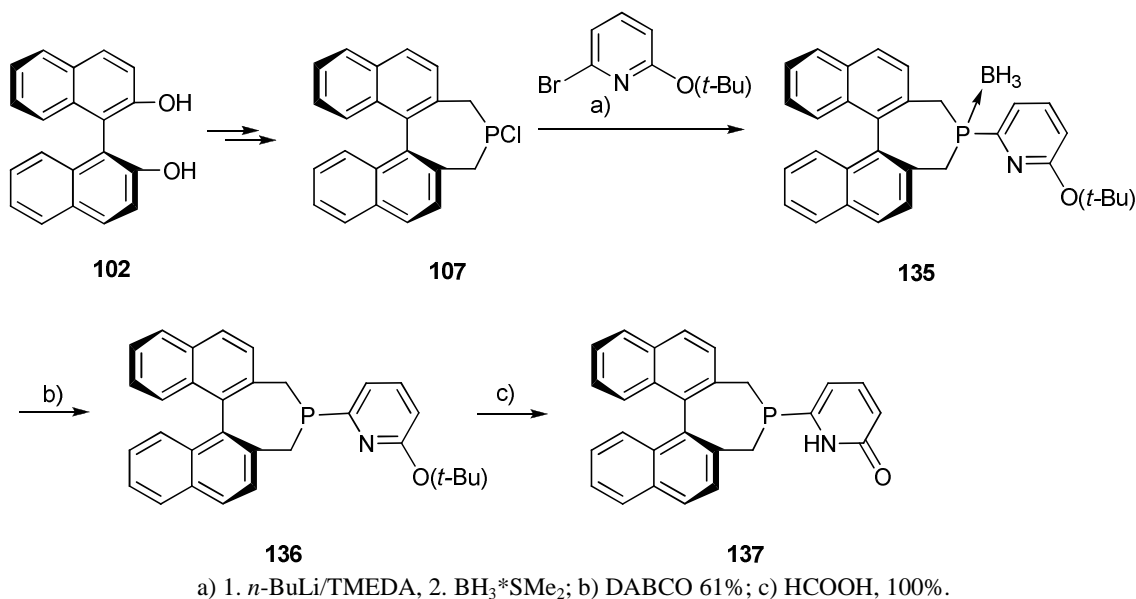

Scheme 44

The diol was converted into (*S*)-phosphine (**107**) through four synthetic steps according to protocols of Beller³⁴ and Zhang.³³ The coupling of **107** with *o*-lithiated 2-(*tert*-butoxy)pyridine followed by reaction with BH₃*SMe₂ led to (*S*)-(-)-4-(6-*tert*-butoxypyrid-2-yl)-4,5-dihydro-3*H*-dinaphtho[2,1-*a*;1',2'-*e*]-phosphine (**136**) which was isolated and purified as its borane adduct **135**. Cleavage of the *tert*-butyl ether with formic acid afforded (*S*)-(-)-4-(1*H*-pyridin-2-on-6-yl)-4,5-dihydro-3*H*-dinaphtho[2,1-*a*;1',2'-*e*]-phosphine (**137**) in quantitative yield.

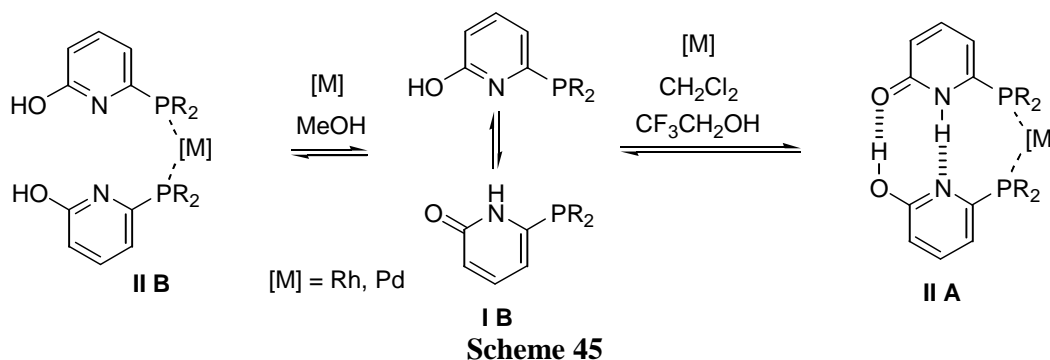

Scheme 45

In the presence of a metal monodentate phosphine ligands such as **137** are able to build up self-assembling aggregates based on hydrogen bondings (Scheme 45).⁴⁹ In particular, in nonpolar solvents like

CH₂Cl₂ or toluene, the pyridone system with its hydroxypyridine tautomer may form strong H-bondings in the backbone of the complex which lead in the result to the formation of “quasi”-chelating bidentate ligands (**II A**).⁴⁸ In polar solvents (MeOH) these H-bondings are cleaved (**II B**).

More recently, we showed that the self-assembling architecture of the metal complex is completely maintained in fluorinated alcohols too, such as 2,2,2-trifluoroethanol (TFE), 2-fluoroethanol and 1,1,1,3,3,3-hexafluoro-2-propanol (HFIP).⁵⁰

3. Asymmetric catalysis with phosphephines

3.1. Asymmetric catalysis with transition metal complexes

3.1.1. Asymmetric hydrogenation

3.1.1.1. Monodentate phosphephines

Due to several comprehensive reviews, which have been already published,^{51,52} herein we will focus only on recent advances including results of the year 2006.

3.1.1.2. Bidentate phosphephines

The efficiency of monodentate phosphephines in asymmetric catalysis was intensively investigated and described by Junge, Beller and co-workers.^{36,45,53,54} They also tested the bidentate phosphephines **131** and **132** as ligands in the Rh-catalyzed hydrogenation of several benchmark substrates such as AMe (methyl α -acetamidocinnamate) and aMe (methyl α -acetamidoacrylate) to show their stereodiscriminating potential (Scheme 46).⁴⁵ In order to elucidate matched- or mismatched relations, both diastereomers were tested.

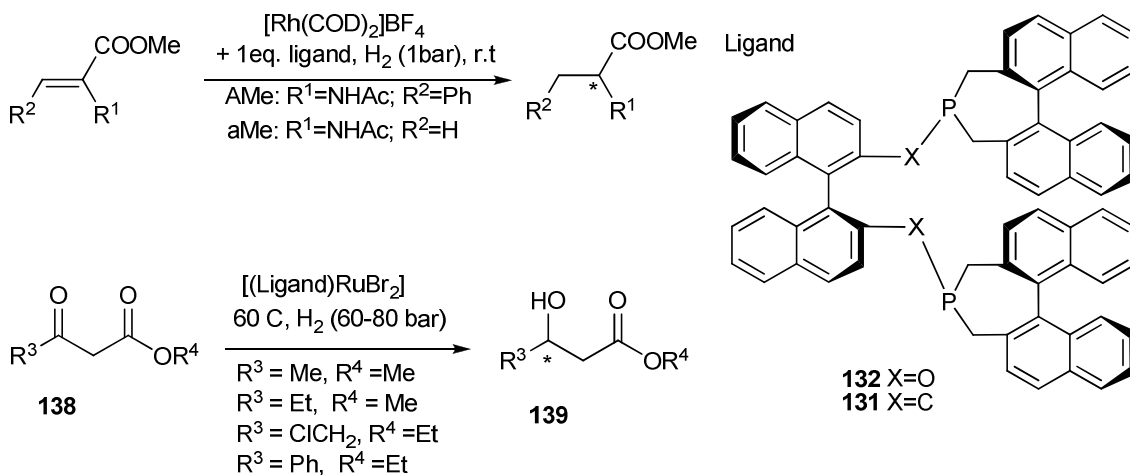

Scheme 46

The catalyst based on (*S,R,S*)-phosphonite **132** led only to the racemic hydrogenation product and represents therefore the mismatched form. In contrast, the matched (*S,S,S*)-phosphonites **132** afforded high enantioselectivities (up to 96% ee for AMe and 98% ee for aMe). It is of interest that a catalyst mixture based on a combination of both diastereomeric phosphephine ligands (*S,S,S* and *S,R,S*) induced only modest enantioselectivity (ee up to 47% for AMe and up to 69% for aMe).

The bidentate phosphephines **131** and **132** were also tested in the Ru-catalyzed asymmetric hydrogenation of β -ketoesters.^{36b} Surprisingly, the use of the bidentate ligand **132** provided lower ee-values in comparison to related monodentate phosphephines **104a-h** (78% vs 95%).

3.1.1.3. Asymmetric hydrogenation with self-assembling phosphepine catalyst

Recently, we investigated the application of self-assembled complexes with (*S*)-(-)-4-(1*H*-pyridin-2-on-6-yl)-4,5-dihydro-3*H*-dinaphtho[2,1-*a*;1',2'-*e*]-phosphepine (**137**) as ligand in the asymmetric hydrogenation (Scheme 47).^{48,50} With ItMe₂ (dimethyl itaconate) and AMe (methyl α -acetamidocinnamate) as substrates, high activity and ee-values up to 99% were noted, which exceeded results commonly obtained with “normal” monodentate phosphepine ligands like **104a** (< 95% ee).

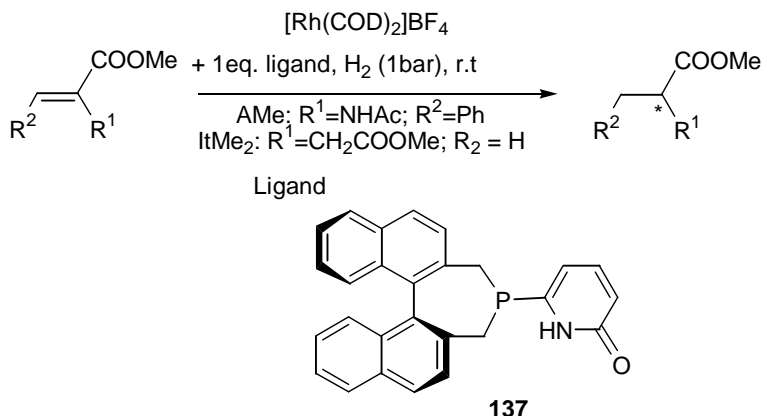

Scheme 47

3.1.2. Rh-catalyzed asymmetric hydroformylation

The first application of phosphepines in asymmetric catalysis was reported 1994 by Gladiali and co-workers and was concerned to the Rh-catalyzed hydroformylation.²⁸ With Rh(CO)₂(acac) as a catalyst precursor, phosphepine **104a** as ligand and styrene as substrate at 60 °C the branched aldehyde was formed in high chemo- and regioselectivity (93%) (Scheme 48). But only poor ee-values were noted (12%). Decreasing the reaction temperature to 30 °C improved both regio- and enantioselectivities up to 95% and 20%, respectively.

In a similar approach, the Beller group utilized bidentate phosphepines **131–132** and the monodentate phosphepine ligands **104a–i** in order to investigate the effect of varying steric and electronic properties.⁴⁷

The best enantioselectivities (up to 48% ee) were obtained with ligand **104g** bearing the donating Me₂N-substituent on the phenyl group. This is up to now the highest ee-value achieved with monodentate ligands in asymmetric hydroformylation. The *t*-Bu and *i*-Pr substituted phosphepines **104b,c** induced lower ee-values. Neither α -substitution to the phosphorus atom (phosphepine **111a**) nor the application of bidentate diphosphine and diphosponite ligands (**131** and **132**) improved the results.

The group of Klosin investigated several P-ligands in the asymmetric hydroformylation of styrene, allyl cyanide and vinyl acetate.⁵⁵ Highest enantioselectivities were achieved with the bidentate Binapine (**130**) (with styrene: 94% ee; allyl cyanide: 94% ee, and vinyl acetate: 87% ee). Unfortunately, the catalytic activities were low. Binaphane (**118**) performed inferior (up to 50% ee).

3.1.3. Pd-catalyzed asymmetric allylic alkylation and amination (Tsuji-Trost reaction)

3.1.3.1. Pd-catalyzed asymmetric allylic alkylation

Palladium-catalyzed asymmetric allylic alkylation with phosphepine as ligands was first reported 2001 by Vasse, Moberg and co-workers.⁴¹ As benchmark substrate was used 1,3-diphenyl-2-propenyl acetate

(140) which was alkylated with malonate using palladium acetate as the palladium source in the presence of bis(trimethylsilyl)acetamide (BSA) and KOAc (Scheme 49).

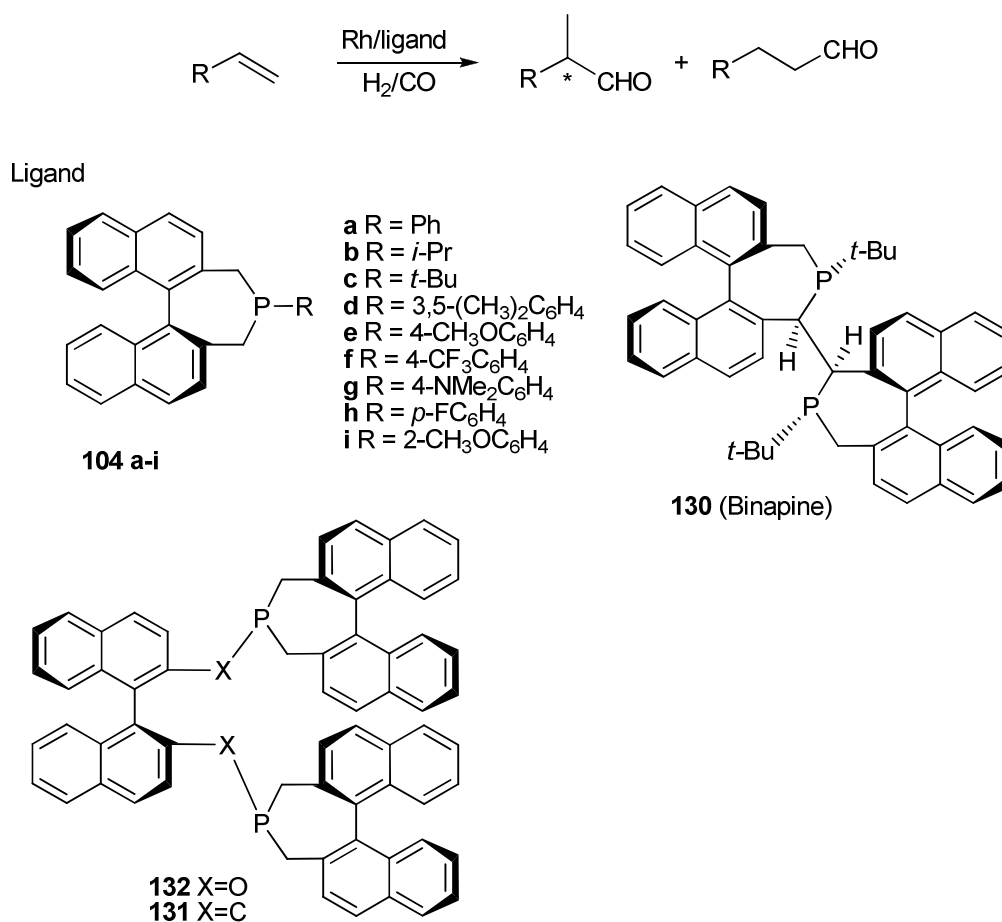

Scheme 48

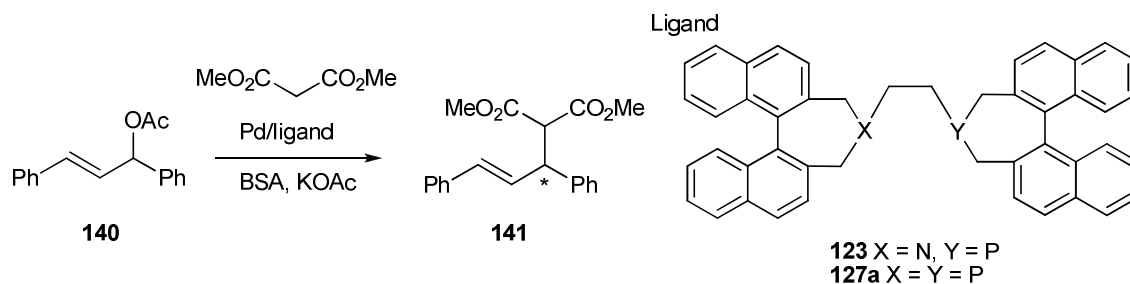

Run	Ligand	X	Y	Time, [h]	Conversion, [%]	Ee, [%]
1	(<i>S,S</i>)- 123	N	P	6	100	98 (<i>S</i>)
2	(<i>R,S</i>)- 123	N	P	72	95	37 (<i>R</i>)
3	(<i>S,S</i>)- 127a	P	P	4	100	94 (<i>S</i>)
4	(<i>S,R</i>)- 127a	P	P	4	20	rac
5	(<i>S</i>)- 125	N	P	4	60	87 (<i>S</i>)
6	(<i>S</i>)- 124	P	N	5	55	78 (<i>S</i>)

Scheme 49

With “*pseudo-C₂*” symmetric P,N-phosphepine ligand (*S,S*)-**123** excellent ee-values and full conversion was obtained after 6 h (run 1). The “*pseudo-meso*” P,N-ligand (*S,R*)-**123** induced only low activity and enantioselectivity (run 2). Next, allylic substitutions using “*pseudo-C₂*” symmetric (*S,S*)-**127a** and “*pseudo-meso*” P,P-ligand (*S,R*)-**127a** were studied. Excellent enantioselectivities were achieved with (*S,S*)-**127a** (run 3). Interestingly, the application of (*S,R*)-**127a** led to racemic product only (run 4). The activity was low. Chirally flexible ligands (*S*)-**125** and (*S*)-**124** showed a smaller degree of variation in enantioselectivity (run 5 and 6).

rac-3-Cyclohexenyl (**142**) were tested in the asymmetric allylic alkylation as substrate too (Scheme 50). Application of the “*pseudo-meso*” P,N-ligand (*R,S*)-**123** provided higher enantioselectivity and activity (26% ee and 70% conversion after 24 h) than the “*pseudo-C₂*” symmetric diastereoisomer (*S,S*)-**123** (12% ee and 40% conversion, respectively).

However, no difference was found in the Pd-catalyzed substitution of cyclopentenyl acetate (**144**) using (*R,S*)-**123** and (*S,S*)-**123**. Similar enantioselectivity (27% ee vs. 26% ee) and activity were noted.

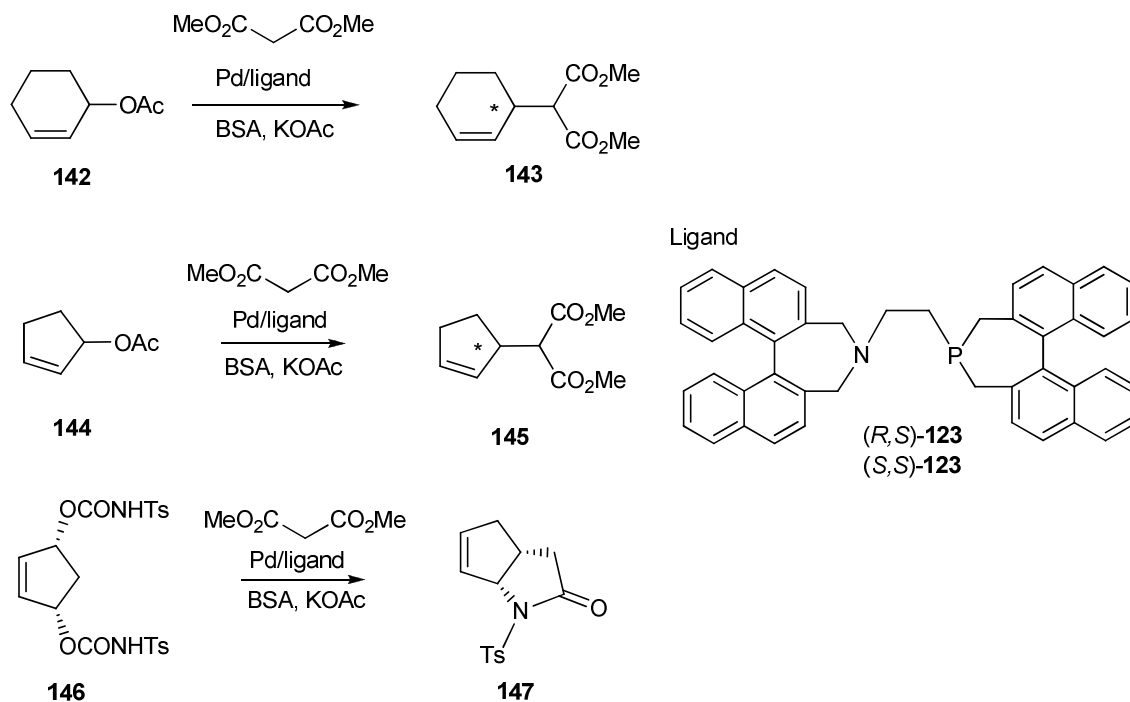

Scheme 50

The possibility to desymmetrize a *meso*-diacetyl compound employing 3,5-cyclopentenyl bisurethane **146** as substrate was analyzed too. Unfortunately, no discrimination of the enantiotopic leaving groups and therefore no enantioselectivity was observed.

3.1.3.2. Pd-catalyzed asymmetric allylic amination

As a benchmark test the reaction of *rac*-(*E*)-1,3-diphenyl-3-acetoxyprop-1-ene (**140**) with benzylamine as a nucleophile was studied (Tsuji-Trost amination) (Scheme 51).⁴² The Pd-catalyst based on the bidentate “*pseudo-C₂*” symmetric P,N-ligand (*S,S*)-**123** gave only modest enantioselectivity and activity (39% ee, full conversion 48 h at 45 °C). Under the same conditions the application of “*pseudo-meso*” P,N-ligand (*R,S*)-**123** led to racemic product in 10% conversion.

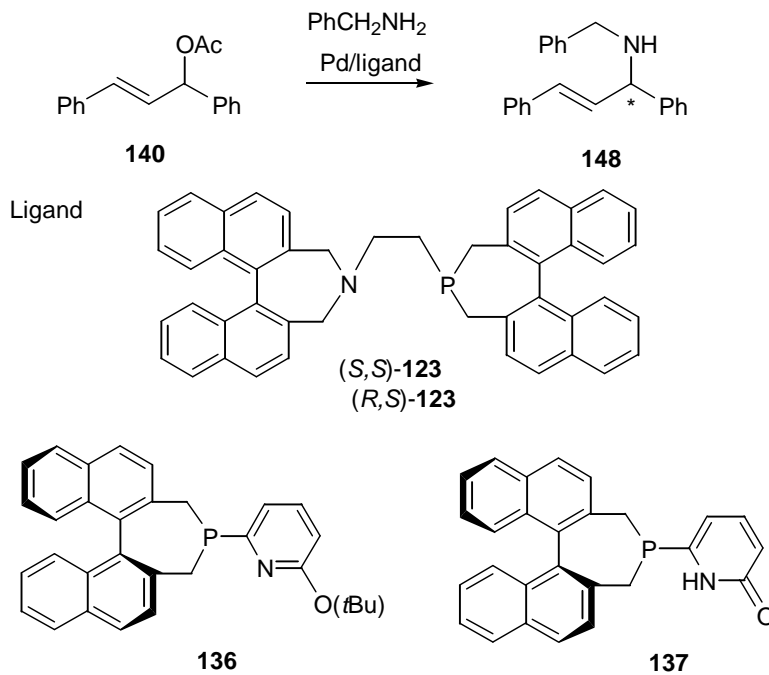

Scheme 51

Recently, our group achieved a significant improvement of enantioselectivity and activity in the amination by application of a catalysts based on the self-assembled phosphine ligand **137**.⁵⁶ Up to 87% ee and full conversion were obtained at room temperature within 4–12 h. Interestingly, with the monodentate phosphine **136** only poor enantioselectivity (up to 14%) was noted.

By usage of organic carbonates, such as propylene carbonate, butylene carbonate and diethyl carbonate as alternative solvents for this reaction with phosphine **137** as ligand moderate enantioselectivities (up to 55% ee) and conversion (up to 74% after 14 h) yielded.⁵⁷

3.1.4. Enantioselective catalytic allylation of carbonyl groups by umpolung of π -allyl palladium complexes

Zanoni, Gladiali and co-workers presented the first example of a catalytic asymmetric addition of aldehydes to an allyl zinc reagent (generated from the corresponding allyl ester and diethylzinc) in the presence of a catalytic amount of a Pd-complex based on phosphine ligands as shown in Scheme 52, path b.⁵⁸

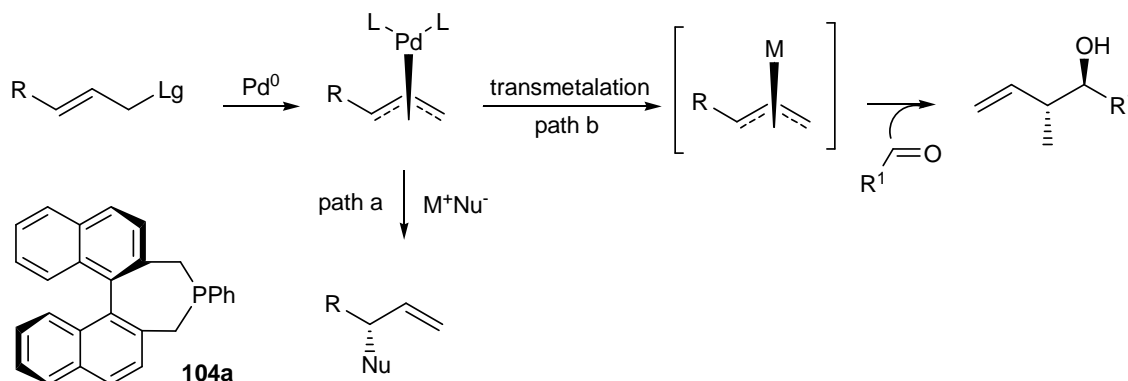

Scheme 52

Path a means nucleophilic displacement at a π -allyl palladium species (Tsuji-Trost reaction). Path b involves prior nucleophilic transmetalation of the π -allyl palladium complex (“umpolung”) for example with diethylzinc and subsequent reaction with aldehydes and ketones.

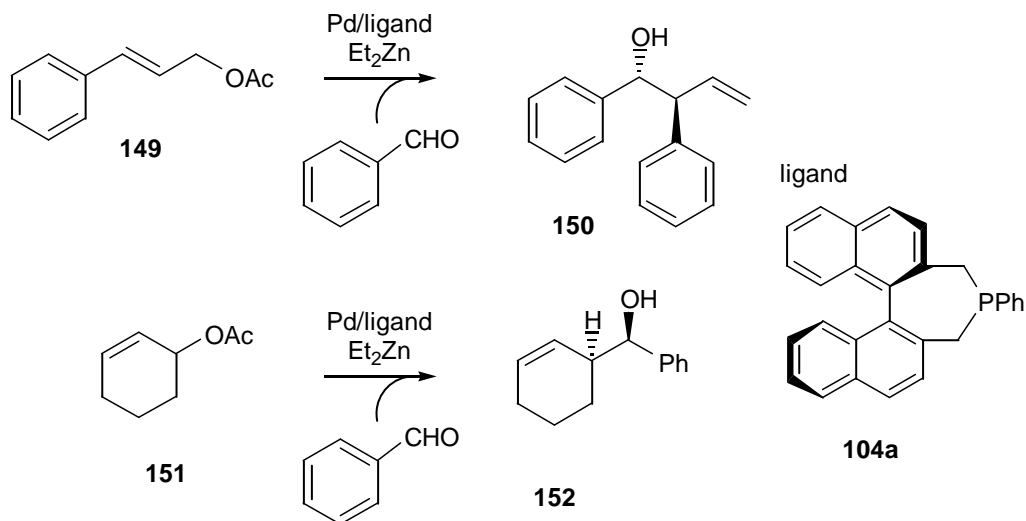

Scheme 53

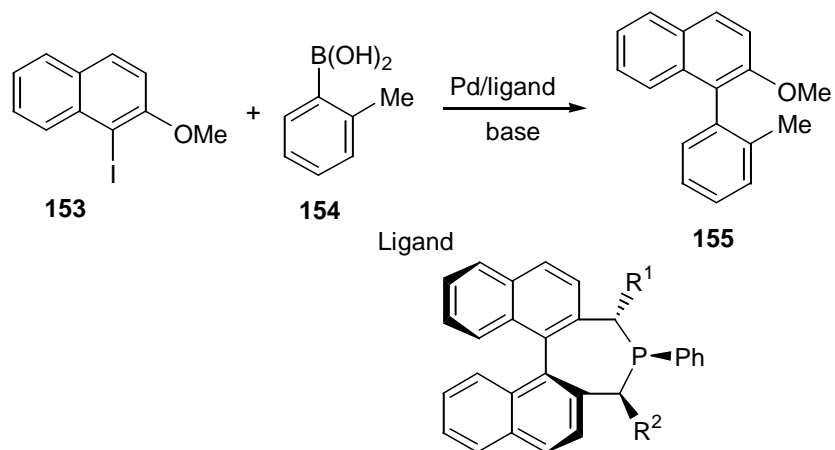

Ligand	R ¹	R ²	Isolated yield, [%]	Ee, [%]
104a	H	H	46	8 (+)
111a	Me	Me	76	12 (+)
111b	Et	Et	21	18 (+)
111c	Bn	Bn	56	14 (+)
112a	Me	H	47	10 (+)
112b	Et	H	32	2 (-)
112c	Bn	H	28	6 (+)

Scheme 54

As substrates were used cinnamyl acetate (**149**) and cyclohexenyl acetate (**151**) (Scheme 53). By employment of phosphine **104a** as ligand with olefin **149** were noted best enantioselectivities and

activities (up to 70% ee, yield 70%). For cyclohexenyl acetate (**151**) lower ee-values (52%) and conversions (60%) yielded.

3.1.5. Pd-mediated Suzuki–Miyaura coupling

The palladium-catalyzed cross coupling between organoboronic acid and halides (Suzuki-Miyaura reaction) with monodentate phosphepines as ligands was studied by Widhalm and co-workers.³⁷ The phosphepines **111** and **112** were tested in the reaction between 1-iodo-2-methoxynaphthalene (**153**) and 2-methoxynaphthalene-1-boronic acid (**154**) (Scheme 54).

The α,α' -dimethyl substituted phosphepine **112a** afforded the highest yield of biaryl product **155** (76%). However, only poor low stereoselectivities were induced (up to 18% ee, **111b**).

3.1.6. Asymmetric hydroboration

The group of Widhalm tested the mono- α - and bis- α,α' -substituted phosphepines **111** and **112** as well as phosphepine **104a** in the rhodium-catalyzed hydroboration of styrene **156** (Scheme 55).³⁷ The hydroborations with catechol borane using phosphepines **111** and **112** as ligands followed by oxidation afforded predominantly the branched product **157**.

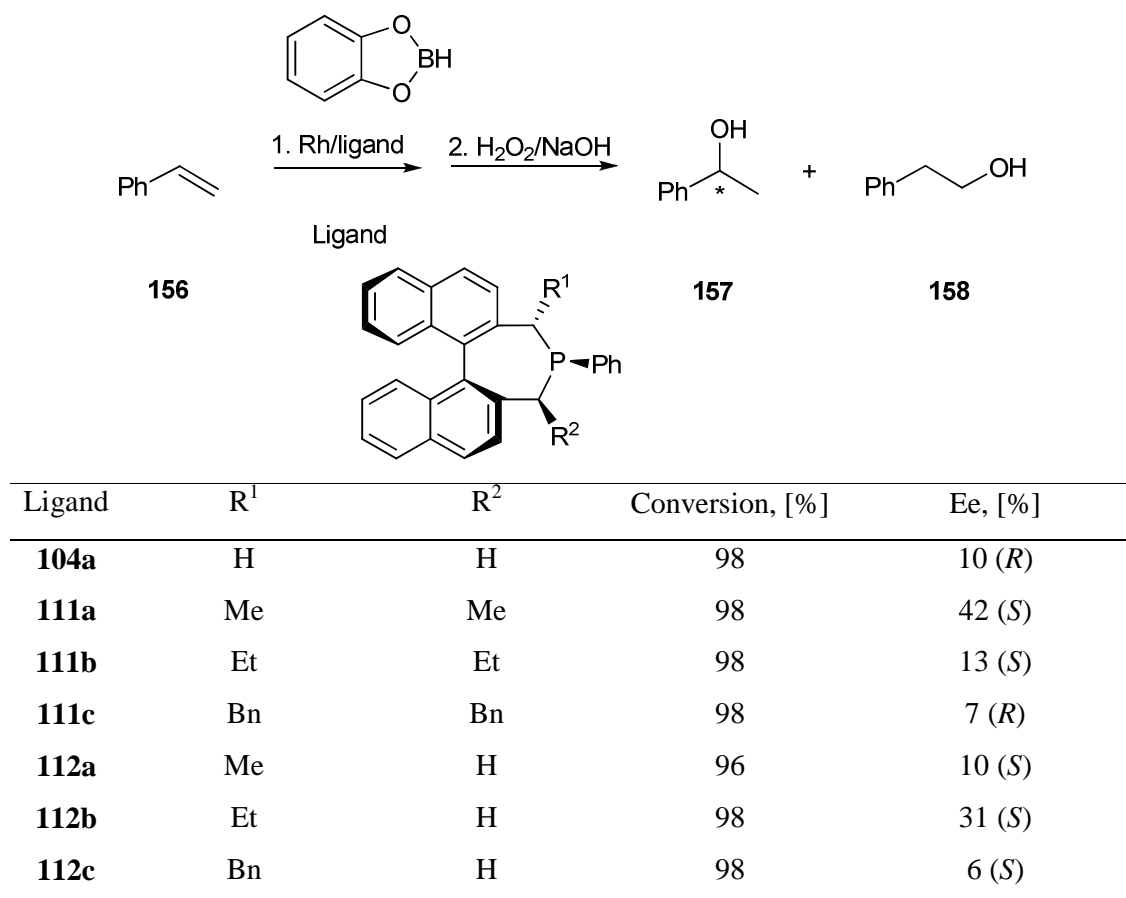

Scheme 55

In general, high conversions (96–98%) and modest enantioselectivities were achieved. The best ee-value (42%) was induced under the assistance of phosphepine **111a**.

3.1.7. Rh-catalyzed 1,4-additions of arylboronic acids to enones

The phosphine ligand bearing an unsaturated side chain **117** was successfully used in the Rh-catalyzed 1,4-addition of arylboronic acids.³⁹ As substrate served cycloalkyl enones **159–161** and lactone **165**, respectively (Scheme 56).

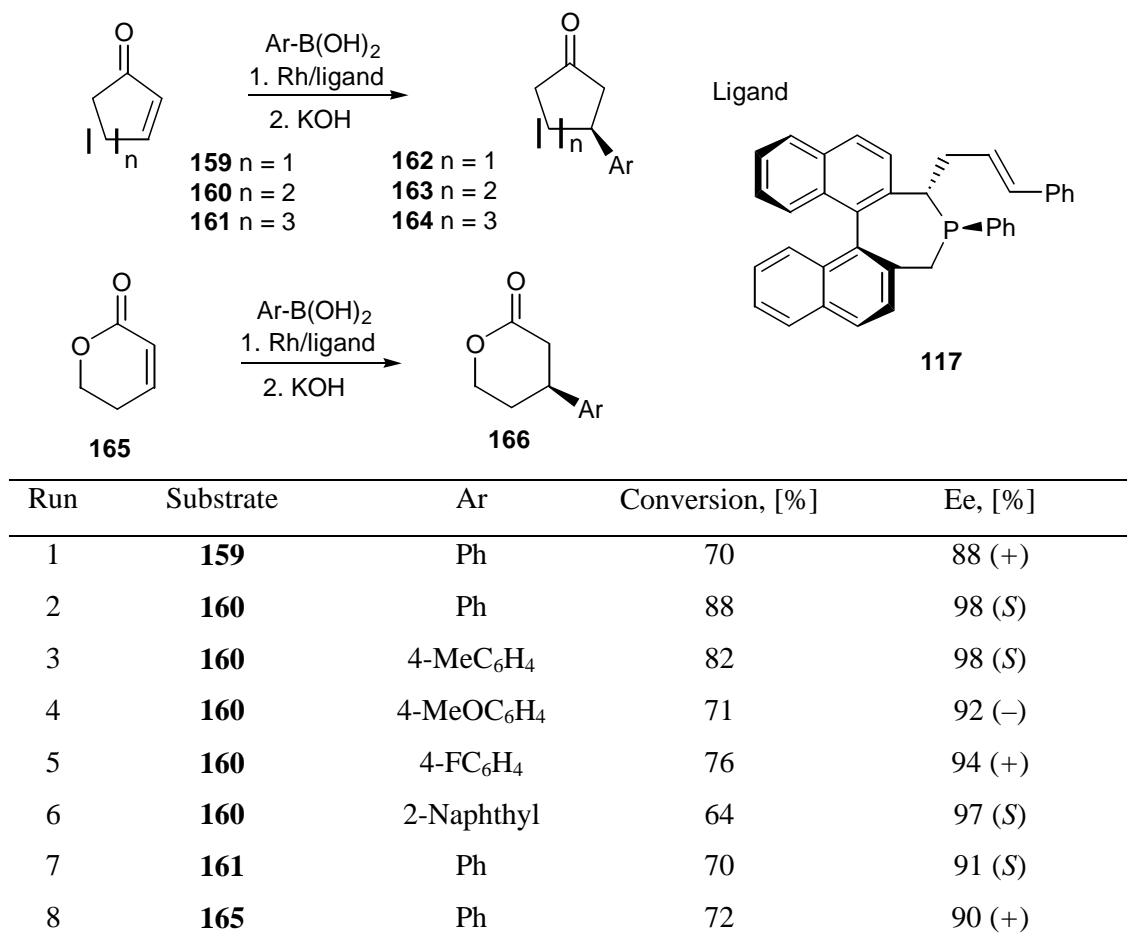

Scheme 56

In all runs fair conversions and high enantioselectivities (ee-value up to 98%, run 2) were observed. The highest enantioselectivity was obtained with cyclohexanone **160** as substrate (98% ee).

3.1.8. Alkoxy- and hydroxycyclization of enynes catalyzed by Pt-catalysts

Recently Michelet, Gladiali and Genêt reported the first Pt(II)-catalyzed asymmetric alkoxycyclization of 1,6-enynes leading to functionalized five-membered carbo- and heterocycles (Scheme 57).⁵⁹

As substrate for this atom-economic reaction, enynes with electron-withdrawing groups were employed. Ligand **104a** induced up to 85% ee in this conversion.

3.2. Organocatalysis

3.2.1. Asymmetric acylations and benzoylations

In 1996, the group of Vedejs presented the first examples of an enantioselective acylation with chiral phosphines as organocatalysts. Among others 4-phenyl-4,5-dihydro-3*H*-dinaphtho[2,1-*c*;1',2'-*e*]phosphine (**104a**) was tested for the conversion of vicinal diols (Scheme 58).⁶⁰

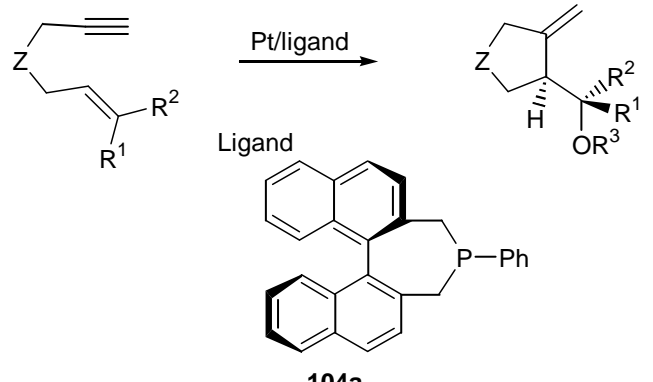

Run	Z	R ¹	R ²	R ³	Conversion, [%]	Ee, [%]
1	C(CO ₂ Me) ₂	H	Ph	H	94	85 (+)
2	NTs	H	Ph	H	86	84 (+)
3	C(CO ₂ Me) ₂	H	CH ₃	H	87	66 (+)
4	NTs	Me	Me	H	57	56 (+)
5	NTs	H	Ph	Me	49	78 (+)
6	C(CO ₂ Me) ₂	Me	Me	Me	100	50 (+)

Scheme 57

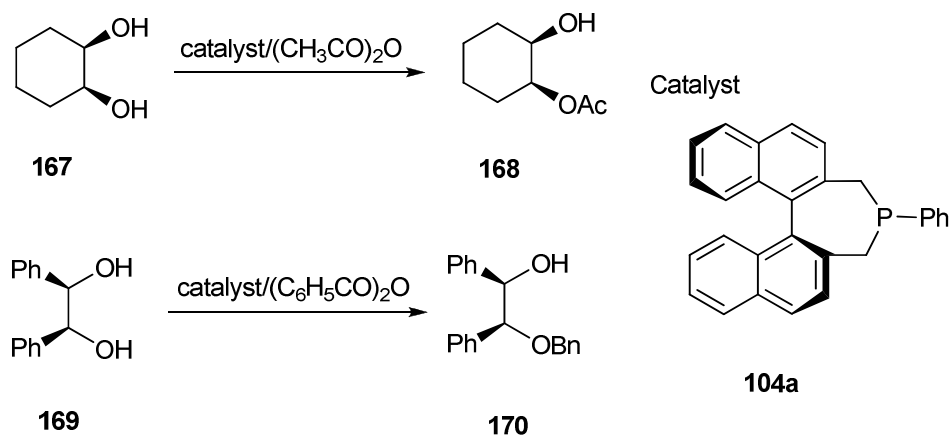

Scheme 58

The desymmetrization of *cis*-cyclohexane-1,2-diol (**167**) using 5–8 mol% of **104a** and acetic anhydride produced monoacetate **168** with 11% ee and a conversion of 60%. In the stereoselective benzylation of hydrobenzoin (**169**) slightly better enantioselectivity (22%) but significantly lower conversion (31%) was noted.

3.2.2. Asymmetric [3+2] cycloadditions of imines with allenes

The reaction represents an important methodology for the construction of functionalized pyrrolines (Scheme 59). The group of Marinetti used phosphepines **104a,c** as nucleophilic catalysts for this [3+2] annulation as a part of a detailed screening.⁶¹ Best results were obtained with allenic esters and *N*-tosylimines, both in terms of enantioselectivity and conversion.

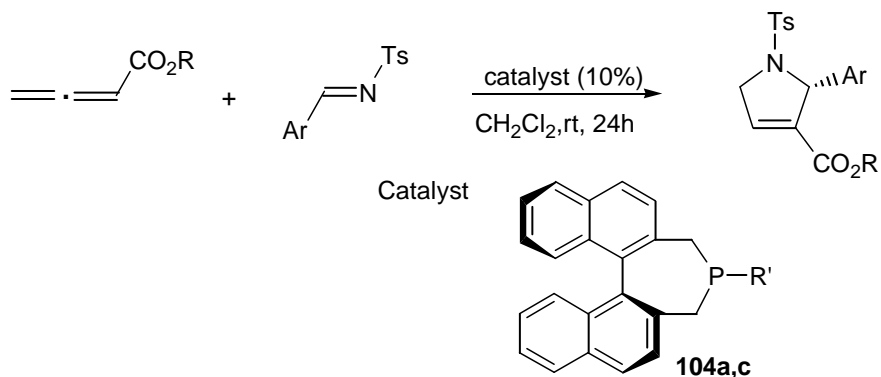

Run	product		phosphine (<i>S</i>)- 104a		phosphine (<i>S</i>)- 104c	
	R	Ar	Conversion, [%]	Ee, [%]	Conversion, [%]	Ee, [%]
1	Et	<i>p</i> -NO ₂ -Ph	70	18	85	43 ^a
2	Et	Ph	76	45	72	71 ^a
3	Et	<i>p</i> -MeO-Ph	52	21	63	79 ^a (86) ^b
4	Et	<i>o</i> -Me-Ph	43	25	80	66 ^a
5	Cy	1-Naphthyl	>95	64	90	41 ^a
6	Cy	<i>p</i> -NO ₂ -Ph	78	38	86	43 ^a
7	Cy	Ph	>95	42	>95	62 ^a
8	Cy	<i>p</i> -MeO-Ph	69	53	84	80 ^a
9	Cy	<i>o</i> -Me-Ph	>95	60	>95	52 ^a

^a In CH₂Cl₂; ^b in acetone

Scheme 59

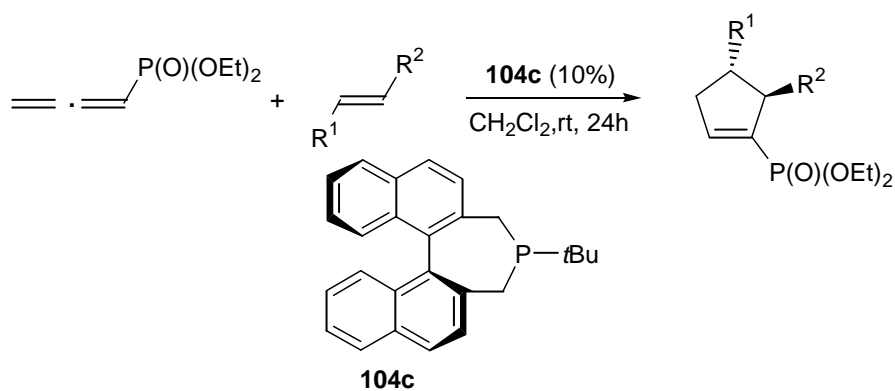

Run	Product		Conversion, [%]	Ee, [%]
	R ¹	R ²		
1	CO ₂ Et	CO ₂ Et	70	91
2	Ph	COPh	35	89
3	<i>p</i> -NO ₂ -Ph	COPh	61	85
4	1-Naphthyl	COPh	9	81

Scheme 60

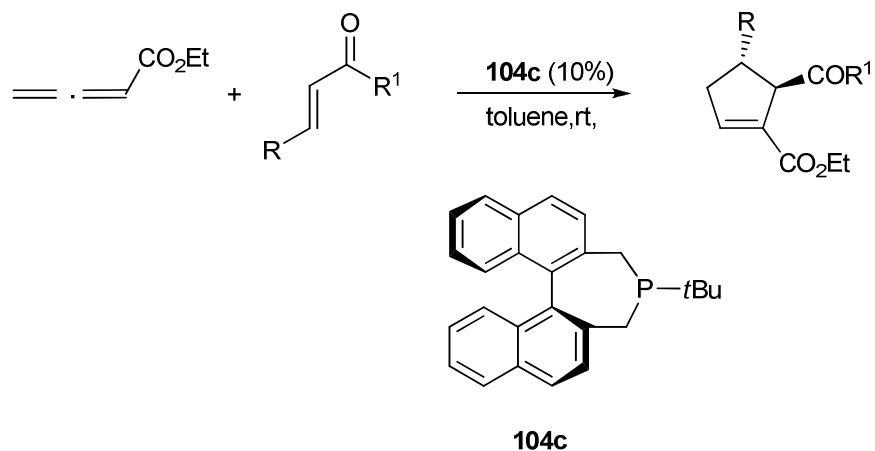

Scheme 61

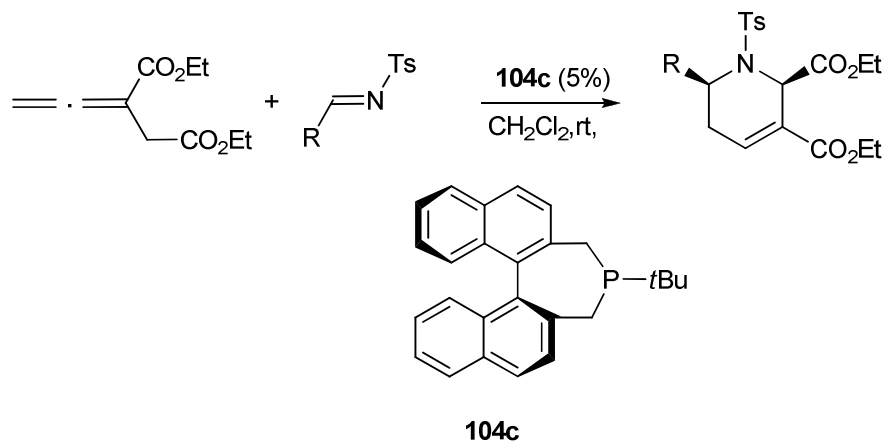

Run	R	Isolated yield, [%]	<i>cis:trans</i>	Ee, [%]
1	Ph	93	91:9	98
2	3-MeC ₆ H ₄	98	93:7	98
3	3,4,5-(MeO) ₃ C ₆ H ₂	86	96:4	45
4	4-MeOC ₆ H ₄	42	93:7	98
5	4-ClC ₆ H ₄	99	91:9	96
6	3-BrC ₆ H ₄	98	89:11	99
7	2-NO ₂ C ₆ H ₄	98	96:4	68
8	2-ClC ₆ H ₄	75	79:21	60
9	2-naphthyl	96	93:7	99
10	2-furyl	98	87:13	97
11	3-pyridyl	76	91:9	97

Scheme 62

The usage of *tert*-butyl-substituted phosphine **104c** as catalyst afforded the best results (run 3). When acetone was employed instead of dichloromethane as a solvent, the enantioselectivity increased up to 86% (run 3).

Recently, the same group employed allenylphosphonates as substrates.⁶² As cyclization partners electron-poor alkenes were chosen (Scheme 60). The *tert*-butyl-substituted phosphepine **104c** was the catalyst of choice.

Despite the harsh reaction conditions (120 °C) high enantioselectivities could be obtained. In the reaction between allenylphosphonates and diethyl fumarate, cyclopentenylphosphonate was obtained in up to 91% ee (run 1).

In 2006 Wilson and Fu have established the first phosphepine-catalyzed enantioselective [3+2]-cycloaddition of allenes with chalcones as depicted Scheme 61.⁶³

When the reactions with allene and chalcone (R=R¹=Ph) were performed at room temperature with phosphepine **104c** as the catalyst, the chiral cyclopentene derivate was obtained with 88% ee. The highest ee-value (90%) was found with a 2-thienyl chalcone derivate (R=Ph, R¹=2-thienyl) in hand.

3.2.3. Asymmetric [4+2] cycloadditions of imines with allenes

In 2003 Kwon developed a method for the synthesis of functionalized piperidines *via* PBU₃-catalyzed [4+2]-annulation of imines with allenes.⁶⁴ Fu and Wurz adopted this method for an asymmetric version and used a chiral phosphepine as organocatalyst⁶⁵ (Scheme 62). Best enantiomeric excess (99%) was obtained with phosphepine **104c**.

In contrast phosphepine **104a** showed only modest enantioselectivity (up to 21%) and diastereoselectivity (74:26), whereas bidentate Binaphane (**118**) revealed to be entirely ineffective in this reaction.

References and notes

1. McNaught, A. D.; Smith P. A. S. In *Comprehensive Heterocyclic Chemistry*; Katritzky, A. P.; Rees, C. W., Eds.; Elsevier Science Ltd, 2007; Vol. 1, p. 12.
2. Robinson, C. N.; Pettit, W. A. *Tetrahedron Lett.* **1972**, *13*, 4977–4978.
3. Dilbeck, G. A.; Morris, D. L.; Berlin, K. D. *J. Org. Chem.* **1975**, *40*, 1150–1157.
4. Montchamp, J.-L.; Tian, F.; Frost, J. W. *J. Org. Chem.* **1995**, *60*, 6076–6081.
5. Maerkl, G.; Burger, W. *Angew. Chem., Int. Ed. Engl.* **1984**, *23*, 894–895.
6. Schuman, M.; Trevitt, M.; Redd, A.; Gouverneur, V. *Angew. Chem. Int. Ed.* **2000**, *39*, 2491–2493.
7. van Assema, S. G. A.; Ehlers, A. W.; de Kanter, F. J. J.; Schakel, M.; Spek, A. L.; Lutz, M.; Lammertsma, K. *Chem. Eur. J.* **2006**, *12*, 4333–4340.
8. Lewis, J. C.; Berman, A. M.; Bergman, R. G.; Ellman, J. A. *J. Am. Chem. Soc.* **2008**, *130*, 2493–2500.
9. Shima, T.; Bauer, E. B.; Hampel, F.; Gladysz, J. A. *Dalton Trans.* **2004**, 1012–1028.
10. Mann, F. G.; Millar, I. T.; Smith, B. S. *J. Chem. Soc.* **1953**, 1130–1134.
11. Suggs, J. L.; Freedman, L. D. *J. Org. Chem.* **1971**, *36*, 2566–2568.
12. Segall, Y.; Shirin, E.; Granoth, I. *Phosphorus, Sulfur, Silicon Relat. Elem.* **1980**, *8*, 243–254.
13. Yasuike, S.; Ohta, H.; Shiratori, S.; Kurita J.; Tsuchiya, T. *J. Chem. Soc., Chem. Commun.* **1993**, 1817–1819.
14. Yasuike, S.; Kiharada, T.; Kurita, J.; Tsuchiya, T. *Chem. Commun.* **1996**, 2183–2184.
15. Barron, A. R.; Hall, S. W.; Cowley A. H. *J. Chem. Soc., Chem. Commun.* **1987**, 1753–1754.
16. Schubert, D. M.; Hackney, M. L. J.; Brand, P. F.; Norman, A. D. *Phosphorus, Sulfur, Silicon Relat. Elem.* **1997**, *123*, 141–160.
17. Maerkl, G.; Dannhardt, G. *Tetrahedron Lett.* **1973**, *14*, 1455–1458.
18. Maerkl, G.; Burger, W. *Tetrahedron Lett.* **1983**, *24*, 2545–2548.
19. Winter, W. *Chem. Ber.* **1976**, *109*, 2405–2419.
20. Luppold, E.; Winter, W. *Chem. Ber.* **1983**, *116*, 1923–1937.
21. Maerkl, G.; Schubert, H. *Tetrahedron Lett.* **1970**, *11*, 1273–1276.

22. Kurita, J.; Shiratori, S.; Yasuike, S.; Tsuchiya, T. *J. Chem. Soc., Chem. Commun.* **1991**, 1227–1228.
23. Quin, L. D.; Middlemas, E. D. *J. Am. Chem. Soc.* **1977**, *99*, 8370–8371.
24. (a) Deschamps, B.; Mathey, F. *Tetrahedron Lett.* **1985**, *26*, 3461–3462. (b) Mathey, F.; Marinetti, A.; Mercier, F. *Synlett* **1992**, 363–370.
25. Märkl, G.; Beckh, H. J.; Ziegler, M. L.; Nuber, B. *Angew. Chem., Int. Ed. Engl.* **1987**, *26*, 1134–1135.
26. (a) Keglevich, G.; Janke, F.; Brlik, J.; Petneházy, I.; Tóth, G.; Töke, L. *Phosphorus, Sulfur, Silicon Relat. Elem.* **1989**, *46*, 69–77. (b) Keglevich, G. *Synthesis* **1993**, *13*, 931–942. (c) Keglevich, G.; Petneházy, I.; Miklós, P.; Almásy, A.; Tóth, G.; Töke, L. *J. Org. Chem.* **1987**, *52*, 3983–3986.
27. (a) Keglevich, G.; Thanh, H. T. T.; Szöllösy, Á.; Újzászy K.; Töke, L. *J. Chem. Soc., Perkin Trans. 1* **1998**, 3323–3324. (b) Keglevich, G.; Thanh, H. T. T.; Ludányi, K.; Novák, T.; Újzászy, K.; Töke, L. *J. Chem. Research (S)* **1998**, 210–211.
28. Gladiali, S.; Dore, A.; Fabbri, D.; De Lucci, O.; Manassero, M. *Tetrahedron: Asymmetry* **1994**, *5*, 511–514.
29. Maignot, N.; Mazaleyrat, J.-P. *Synthesis* **1985**, *3*, 317–324.
30. Tani, K.; Brown, L. D.; Ahmed, J.; Ibers, J. A.; Yokota, M.; Nakamura, A.; Otsuka, S. *J. Am. Chem. Soc.* **1977**, *99*, 7876–7886.
31. Bitterer, F.; Herd, O.; Kühnel, M.; Stelzer, O.; Weferling, N.; Sheldrick, W. S.; Hahn, J.; Nagel, S.; Rolsch, N. *Inorg. Chem.* **1998**, *37*, 6408–6417.
32. Okucu, S.; Karaçar, A.; Freytag, M.; Jones, P. G.; Schmutzler, R. *Z. Anorg. Allg. Chem.* **2002**, *628*, 1339–1345.
33. Xiao, D.; Zhang, Z.; Zhang, X. *Org. Lett.* **1999**, *1*, 1679–1681.
34. Junge, K.; Oehme, G.; Monsees, A.; Riermeier, T.; Dingerdissen, U.; Beller, M. *Tetrahedron Lett.* **2002**, *43*, 4977–4980.
35. Chi, Y.; Zhang, X. *Tetrahedron Lett.* **2002**, *43*, 4849–4852.
36. (a) Junge, K.; Hagemann, B.; Enthaler, S.; Spannenberg, A.; Michalik, M.; Oehme, G.; Monsees, A.; Riermeier, T.; Beller, M. *Tetrahedron: Asymmetry* **2004**, *15*, 2621–2631. (b) Hagemann, B.; Junge, K.; Enthaler, S.; Michalik, M.; Riermeier, T.; Monsees, A.; Beller, M. *Adv. Synth. Catal.* **2005**, *347*, 1978–1986.
37. Kasák, P.; Mereiter, K.; Widhalm, M. *Tetrahedron: Asymmetry* **2005**, *16*, 3416–3426.
38. Enthaler, S.; Erre, G.; Junge, K.; Michalik, D.; Spannenberg, A.; Marras, F.; Gladiali, S.; Beller, M. *Tetrahedron: Asymmetry* **2007**, *18*, 1288–1298.
39. Kasák, P.; Arion, V. B.; Widhalm, M. *Tetrahedron: Asymmetry* **2006**, *17*, 3084–3090.
40. Xiao, D.; Zhang, X. *Angew. Chem. Int. Ed.* **2001**, *39*, 2491–2493.
41. Stranne, R.; Vasse, J.-L.; Moberg, C. *Org. Lett.* **2001**, *3*, 2525–2528.
42. Vasse, J.-L.; Stranne, R.; Zalubovskis, R.; Gayet, C.; Moberg, C. *J. Org. Chem.* **2003**, *68*, 3258–3270.
43. Klein, H.; Jackstell, R.; Wiese, K.-D.; Borgmann, C.; Beller, M. *Angew. Chem. Int. Ed.* **2001**, *40*, 3408–3411.
44. Tang, W.; Wang, W.; Chi, Y.; Zhang, X. *Angew. Chem. Int. Ed.* **2003**, *42*, 3509–3511.
45. Junge, K.; Hagemann, B.; Enthaler, S.; Erre, G.; Beller, M. *Arkivoc*, **2007**, v, 50–66.
46. (a) Kurz, L.; Lee, G.; Morgans, D.; Waldyke, M. J.; Ward, T. *Tetrahedron Lett.* **1990**, 6321–6324. (b) Uozumi, Y.; Tanahashi, A.; Lee, S.-Y.; Hayashi, T. *J. Org. Chem.* **1993**, *58*, 1945–1948.
47. Erre, G.; Enthaler, S.; Junge, K.; Gladiali, S.; Beller, M. *J. Mol. Catal. A: Chemical* **2008**, *280*, 148–155.
48. Birkholz, M.-N.; Dubrovina, N. V.; Jiao, H.; Michalik, D.; Holz, J.; Paciello, R.; Breit, B.; Börner, A. *Chem. Eur. J.* **2007**, *13*, 5896–5907.
49. For the 6-diphenylphosphinopyridone system, see: Breit, B.; Seiche, W. *J. Am. Chem. Soc.* **2003**, *125*, 6608–6609.
50. Dubrovina, N. V.; Shuklov, I. A.; Birkholz, M.-N.; Michalik, D.; Paciello, R.; Börner, A. *Adv. Synth. Catal.* **2007**, *349*, 2183–2187.
51. Gladiali, S.; Alberico, E. In *Phosphorus Ligands in Asymmetric Catalysis*; Börner, A., Ed; Wiley-VCH: Weinheim, 2008; Vol. 1, pp. 177–206.
52. Erre, G.; Enthaler, S.; Junge, K.; Gladiali, S.; Beller, M. *Coord. Chem. Rev.* **2008**, *252*, 471–491.

53. Enthaler, S.; Erre, G.; Junge, K.; Holz, J.; Börner, A.; Alberico, E.; Nieddu, I.; Gladiali, S.; Beller, M. *Org. Proc. Res. Dev.* **2007**, *11*, 568–577.
54. Junge, K.; Hagemann, B.; Enthaler, S.; Oehme, G.; Michalik, M.; Monsees, A.; Riermeier, T.; Dingerdissen, U.; Beller, M. *Angew. Chem. Int. Ed.* **2004**, *43*, 5066–5069.
55. Axtell, A. T.; Klosin, J.; Abboud, A. K. *Organometallics* **2006**, *25*, 5003–5009.
56. Birkholz, M.-N.; Dubrovina, N. V.; Shuklov, I. A.; Holz, J.; Paciello, R.; Waloch, C.; Breit, B.; Börner, A. *Tetrahedron: Asymmetry* **2007**, *18*, 2055–2060.
57. Schäffner, B.; Holz, J.; Verevkin, S. P.; Börner, A. *ChemSusChem* **2008**, *1*, 249–253.
58. Zanoni, G.; Gladiali, S.; Marchetti, A.; Piccinini, P.; Tredici, I.; Vidari, G. *Angew. Chem. Int. Ed.* **2004**, *43*, 846–846.
59. (a) Charruault, L.; Michelet, V.; Taras, R.; Gladiali, S.; Genêt, J.-P. *Chem. Commun.* **2004**, 850–851.
(b) Michelet, V.; Charruault, L.; Gladiali, S.; Genêt, J.-P. *Pure Appl. Chem.* **2006**, *78*, 397–407.
60. Vedejs, E.; Daugulis, O.; Diver, S. T. *J. Org. Chem.* **1996**, *61*, 430–431.
61. Fleury-Brégeot, N.; Jean, L.; Retailleau, P.; Marinetti, A. *Tetrahedron* **2007**, *63*, 11920–11927.
62. Panossian, A.; Fleury-Brégeot, N.; Marinetti, A. *Eur. J. Org. Chem.* **2008**, 3826–3833.
63. Wilson, J. E.; Fu, G. C. *Angew. Chem. Int. Ed.* **2006**, *45*, 1426–1429.
64. Zhu, X.-F.; Lan, J.; Kwon, O. *J. Am. Chem. Soc.* **2003**, *125*, 4716–4717.
65. Wurz, R. P.; Fu, G. C. *J. Am. Chem. Soc.* **2005**, *127*, 12234–12235.

CYCLIC PHOSPHO DI- AND TRIESTER AS STRUCTURAL ELEMENTS OF NUCLEIC ACIDS

Christelle Dupouy, Corinne Payraastre and Jean-Marc Escudier*

Laboratoire Synthèse et Physico-Chimie de Molécules d'Intérêt Biologique, CNRS UMR 5068, Université Paul Sabatier, F-31062 Toulouse, France (e-mail: escudier@chimie.ups-tlse.fr)

Abstract. *We describe the different approaches towards the introduction of conformationally constraints into nucleic acids by means of cyclic phospho di- or triester in order to produce biological relevant structure mimics. Constraints along the sugar-phosphate backbone were first introduced by synthesis of macrocyclic structures. By use of the Ring-Closing Metathesis, medium size cyclic phosphotriester rings were reached. Finally, dioxaphosphorinane rings were introduced at key position along the sugar-phosphate backbone allowing the control of the six torsion angles.*

Contents

1. Introduction
 - 1.1. Nucleotides conformation
 - 1.2. Nucleic acids primary and secondary structures
 - 1.3. Modified nucleic acids
 2. Macrocyclic phosphate esters
 - 2.1. U-Turn model
 - 2.2. 5'-Cyclouridylic acid and derivatives
 - 2.3. Synthesis of cyclic di- and trinucleotide by Ring Closure Metathesis (RCM)
 3. Dioxaphosphorinane-Constrained Nucleic Acid
 - 3.1. Diastereoselective synthesis of α,β -D-CNA
 - 3.2. Synthesis of α,β,γ -D-CNA and δ,ϵ,ζ -D-CNA
 - 3.3. Nucleosidic and sugar based approach towards ϵ,ζ -D-CNA
 - 3.4. Structural assignment
 - 3.5. Preliminary results on DNA duplex stabilization
 4. Conclusions
- Acknowledgments
- References

1. Introduction

While the backbone organization of double-stranded DNA and RNA is normally quite regular, there are many other secondary and tertiary structures that DNA and RNA molecules can adapt *in vivo*.¹ It is now well established that these disparate structures, which are prone to promote a significant local conformational heterogeneity in the sugar-phosphate backbone, play a crucial role in fundamental biological processes where protein-nucleic acid interactions, RNA folding or RNA catalytic activity are involved.² This conformational property allows RNA to adopt biologically important disparate structures such as bulges,

hairpin loops, U-turns, adenosine platforms or branched junctions. An increasing number of studies indicate that these structural motifs are indeed characterized by a variety of backbone conformations which markedly differ from the regular conformational states of double-stranded DNA and RNA molecules.^{3–8} The actual role played by the phosphate diester backbone in defining these structures is still not well understood. The flexibility of the phosphodiester linkage is expected to be an important component of this “second genetic code”.⁹

Considering the importance of the relationship between the local conformational and functional properties of nucleic acids, conformationally restricted oligonucleotides with modifications in the phosphodiester backbone unit, in the sugar unit and, to a limited extent, in the base units have been designed to efficiently sequester specific mRNA sequences with the background of antisense applications.^{10–13} Since these modifications are introduced for the purpose of forming the strongest duplexes with the target complementary RNA, they do not lead to dramatic changes of the backbone torsion angles α – ζ (Figure 1) compared to the values observed in a natural nucleotide unit in a A- or B-form duplex.¹⁴ To our knowledge, much less attention has been paid to the design of conformationally restricted nucleosides with the aim of mimicking nucleic acid secondary structures containing non-Watson–Crick pairs or unpaired nucleotides. We are interested in the development of conformationally constrained dinucleotide building units in which the backbone torsional angles α – ζ can have predefined values that are significantly different from the typical values observed in DNA and RNA duplexes. In that context, the present paper will describe the last proposals and recent advances towards introduction of conformational constraints into nucleotides by means of cyclic phosphate structures.

1.1. Nucleotides conformation

Nucleic acids are made of nucleotide building blocks. Each nucleoside consists of a sugar, a nucleobase and a phosphodiester linkage. Each nucleotide has six variable backbone torsional angles (denoted as α to ζ) and a glycosidic torsion angle (χ) (Figure 1).

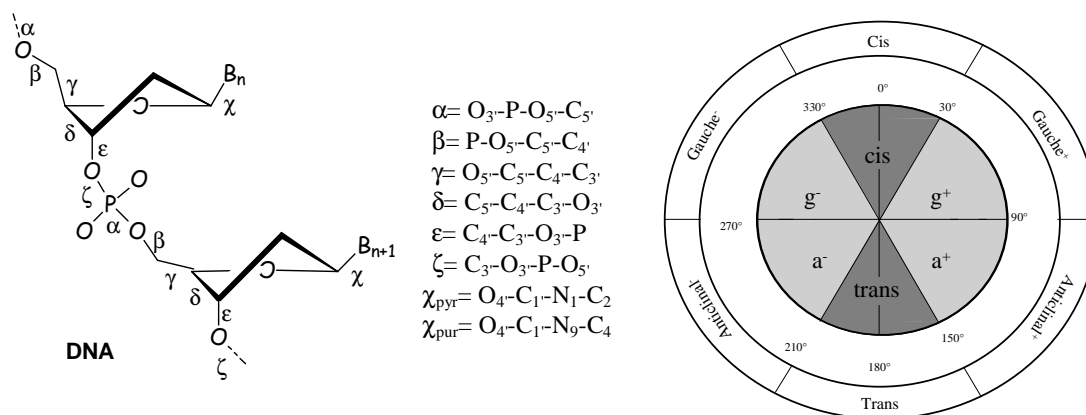

Figure 1. The main torsion angles that describe the nucleic acid backbone structure (α to ζ) and torsion angle χ that describes the orientation of the nucleobase relative to the sugar.

The major difference between DNA and RNA is the presence of the 2'-hydroxyl function in RNA which is lacking in DNA. This change in the sugar gives rise to a distinctly different conformation preference of the sugar ring (Figure 2). The predominant conformation of the sugar moiety in RNA is referred to as *North* conformation (3'-endo) and to as *South* conformation in DNA (2'-endo).

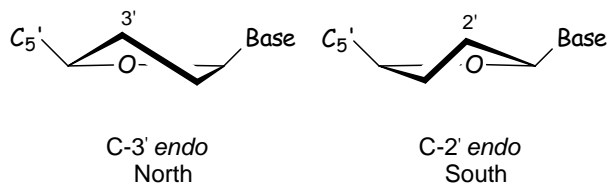

Figure 2. Ribose conformations.

This subtle change in the puckering of the ribose ring will be responsible of the two distinctive morphologies of A- and B-type duplex structures of nucleic acids.

1.2. Nucleic acids primary and secondary structures

Two consecutive nucleotides are connected to each others by a phosphodiester linkage between the 5'-O and 3'-O in a DNA or RNA strand. Each strand can therefore be associated with its complementary counterpart following the Watson-Crick base pairing rules.

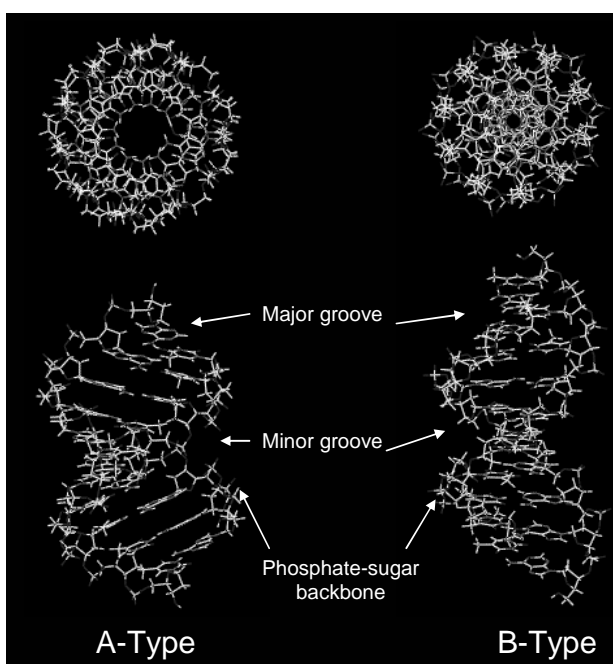

Figure 3. A- and B-type duplex of DNA.

Table 1. Summary of the backbone torsion angles derived from the canonical B-, and A-DNA duplex structures.^a

Duplex conformation	Torsion angle					
	α	β	γ	δ	ϵ	ζ
B	g^-	t	g^+	a^+	t	g^-/a^-
A	g^-	t	g^+	g^+/a^+	a^-/t	g^-

^aThe following 6-fold staggered pattern of the torsional angles is used: *cis* = 0–30° (c), *gauche*(+) = 60–30° (g^+), *antiperiplanar*(+) = 120–30° (a^+), *trans* = 180–30° (t), *antiperiplanar*(-) = 240–30° (a^-), *gauche*(-) = 300–30° (g^-). The notation a^-/t is used to designate a torsion angle on the border of *antiperiplanar*(-) and *trans*.

The most usual structure of DNA (B-type) is a double-stranded right-handed helix with a negatively charged backbone on the outside and stacked base pairs on the inside (Figure 3).¹⁵⁻¹⁷ RNA can adopt a so called A-type duplex that differs from the B-type by the size of the grooves, the number of nucleotides per helix step and the level of hydration. The difference between these two duplex structures originate from the sugar pucker and can be characterized by a transition of the torsional angles δ and ζ from *gauche*(+)/*gauche*(-) in the A-type to *anticlinal*(+)/*anticlinal*(-) in the B-type duplex. The average values observed for the torsional angles α to ζ in A- or B-type duplex are summarized in Table 1 and would be designate as canonical values.¹⁸

Among the highly regular double helix structure, nucleic acids can fold in a wide variety of complex structures that may involve numerous non-Watson-Crick base pairing or unpaired bases (Figure 4). These bulge, junction or hairpin structures are characterized by phosphate-sugar backbone torsional angles values that greatly differ from those observed in the regular states of the duplex. These disparate structures are involved in many relevant biological processes such as DNA replication, nucleic acid/protein recognition, nucleic acids interaction and nucleic acids catalytic activities.¹⁹

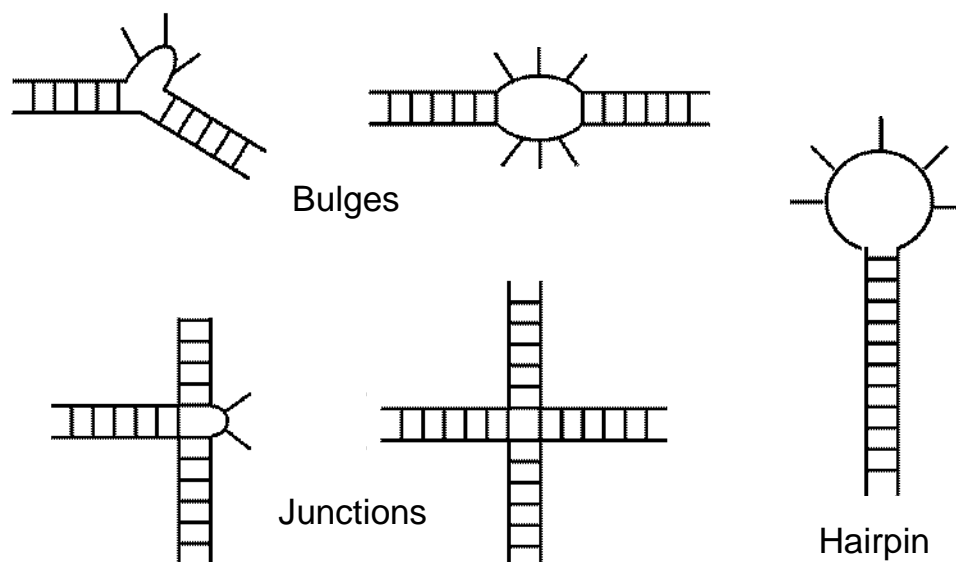

Figure 4. Secondary structures of nucleic acids.

1.3. Modified nucleic acids

Because most, if not all, of the expected applications of DNA analogues rely on their ability to form stable and specific helical complexes to a target nucleic acid, much attention has been devoted to the design of synthetic analogues with enhanced binding properties and/or enzymatic stability.²⁰ In that context, among all the introduced modifications that cannot be reviewed here, a few emerged as prominent examples of class of compounds that induced conformational restriction to nucleic acids (Figure 5). Thiol-modified nucleosides developed by Glick and co-workers are compounds bearing a sulphide function on the base.²¹ They were designed to be incorporated at precise location within each strand of the DNA or RNA in order to form disulfide cross-linked structure.²² Among all the sugar pucker conformational restriction described,

the tricyclo-DNA described by Leumann's group²³ and the LNA/BNA synthesized in the Imanishi's²⁴ and Wengel's laboratory²⁵ are two modifications inducing high duplex stabilisation (up to +3 ° and +8 °C/mod, respectively) mainly due to the entropic benefit provided by a preorganized sugar conformation.

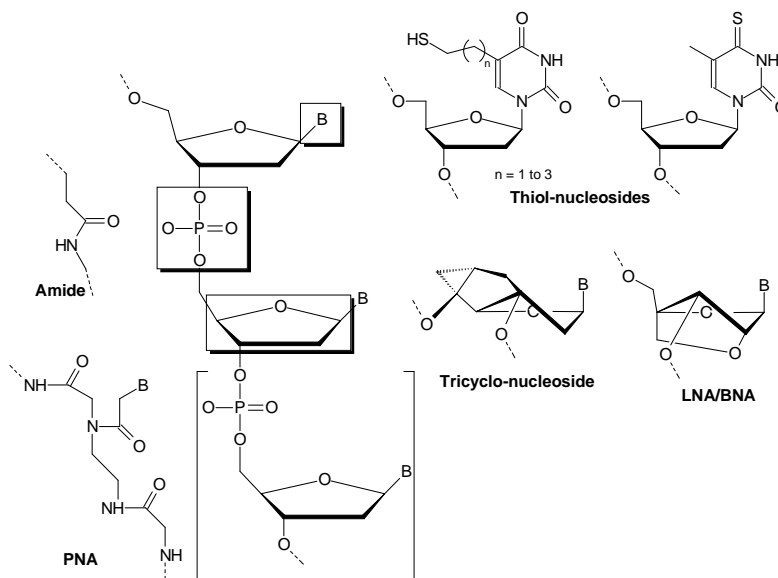

Figure 5. Examples of conformational constraints inducing nucleosides analogues.

On the other hand, conformational rigidity has also been introduced by replacing the internucleotidic phosphodiester moiety by amide linkages with a nice success.²⁶ Nevertheless, to date the Peptidic Nucleic Acids (PNA) stand for the modification that induces the major stabilization effect in nucleic acids.^{27,28} In these molecules, both the sugar and the phosphate have been replaced by amide.

2. Macrocyclic phosphate esters

A successful approach developed to stabilize duplexes, hairpins, higher order structures like triplexes, no ground-state conformations and even tRNAs, was to connect the strands that comprise such structures with disulfide cross-links.²² However, this chemistry was devoted to fix a pre-existing conformation of a defined structure. The introduction of constraint on the sugar-phosphate backbone by connecting a phosphate to a base, a sugar moiety or another phosphate of the same strand will provide new opportunity to provide conformationally constrained nucleic acids mimics.

2.1. U-Turn model

In the late 90's, Sekine and co-workers were interested in developing mimics of the U-turn structure.²⁹ This sharply bent conformation has been commonly found in the anticodon loop of tRNAs and later discovered at the active site of the crystal structure of hammerhead ribozymes. In order to clarify the conformational significance of the U-turn structural element, this group has synthesized sterically fixed U-turn mimics. The conformational properties of the U-turn region could originate from an interresidual hydrogen bonding between the 2'-hydroxyl group of the 33rd uridine (U₃₃) and the amino group of 34th 5-[(methylamino)-methyl]thiouridine (mm⁵s²U₃₄). Therefore, they focused on the preparation of two cyclic diuridylates in which the two nucleosides moieties were connected either by an aminomethyl group or by a carbamate function (Figure 6).

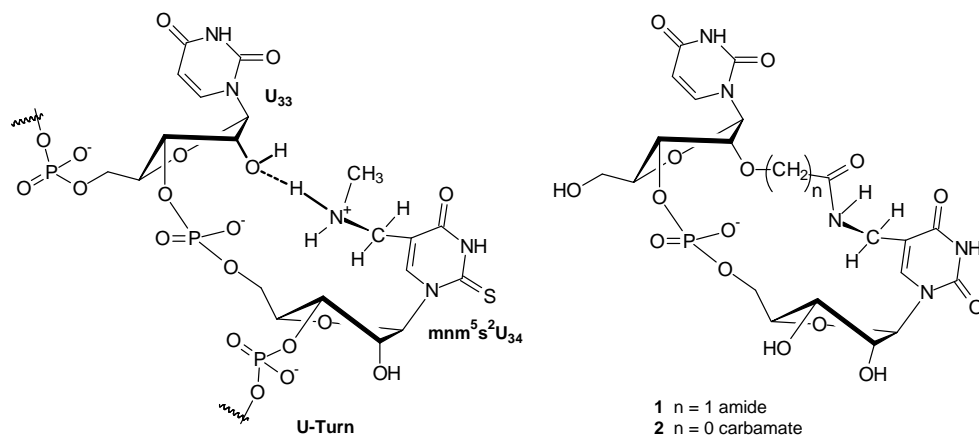
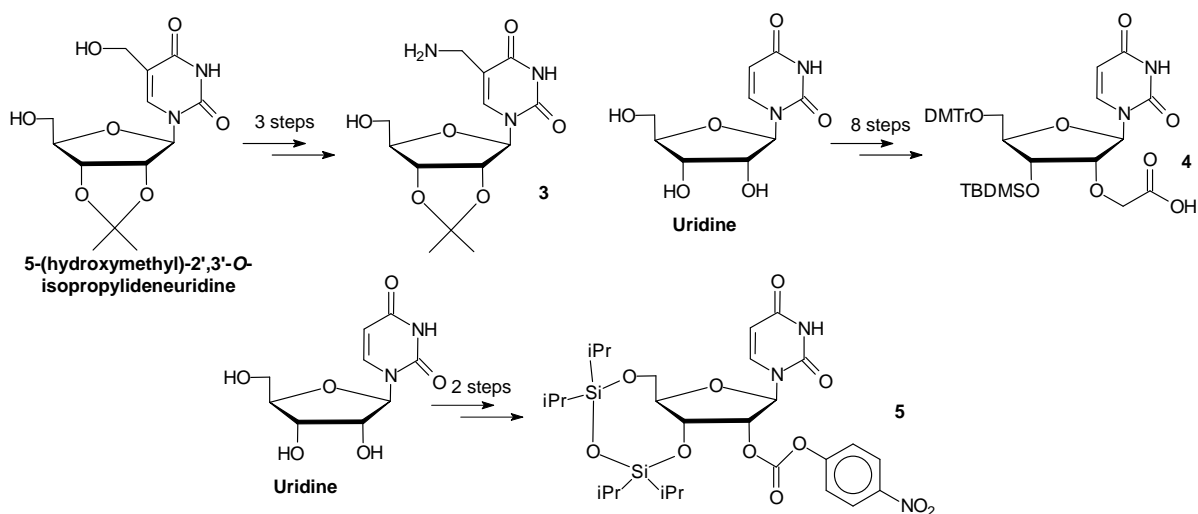

Figure 6. The minimum *U*-turn motif and structures of conformationally constrained dinucleotides mimics.

The two macrocyclic structures **1** and **2** were prepared from a common intermediate **3** bearing an aminomethyl group at position 5 of the uridine (Scheme 1). This compound was synthesized in three steps from 5-(hydroxymethyl)-2',3'-*O*-isopropylideneuridine³⁰ by a chlorination followed by displacement with sodium azide and a Letsinger's reduction³¹ provided **3** in 35% overall yield. On the other hand, suitably functionalized 2'-*O*-uridine have to be prepared either to build an amide (**4**) or a carbamate junction (**5**). Starting from uridine, selective protection of the 5' and 3' hydroxyl functions and of the imide group permitted the 2'-*O*-alkylation with *tert*-butylbromoacetate. Therefore, selective protection/deprotection procedures provided **4** in eight steps from uridine (~30% yield). Access to **5** was more straightforward in nearly quantitative yield and in two steps from uridine after silylation of the 5' and 3' hydroxyl functions and introduction of the reactive 4-nitrophenylcarbonate function at 2'-*O*-position by action of 4-nitrophenylchloroformate.



Scheme 1. Building blocks for the elaboration of amide- and carbamate-linked diuridines.

The amide-linked dinucleotide **1** was then accessible from conjugation of **3** and **4** (Scheme 2). Activation of the carboxylic function of **4** with *N*-hydroxysuccinimide favoured the formation of the amide when reacted with **3**. Subsequent phosphorylation of the primary hydroxyl function and removal of the silyl protective group provided the key acyclic intermediate **6** that was cyclized using isodurenedisulfonyl

dichloride and 1*H*-tetrazole³² in a moderate 50% yield. Further, two deprotection steps gave the desired amino-linked dinucleotide **1** in 23% overall yield from **3** and **4**.

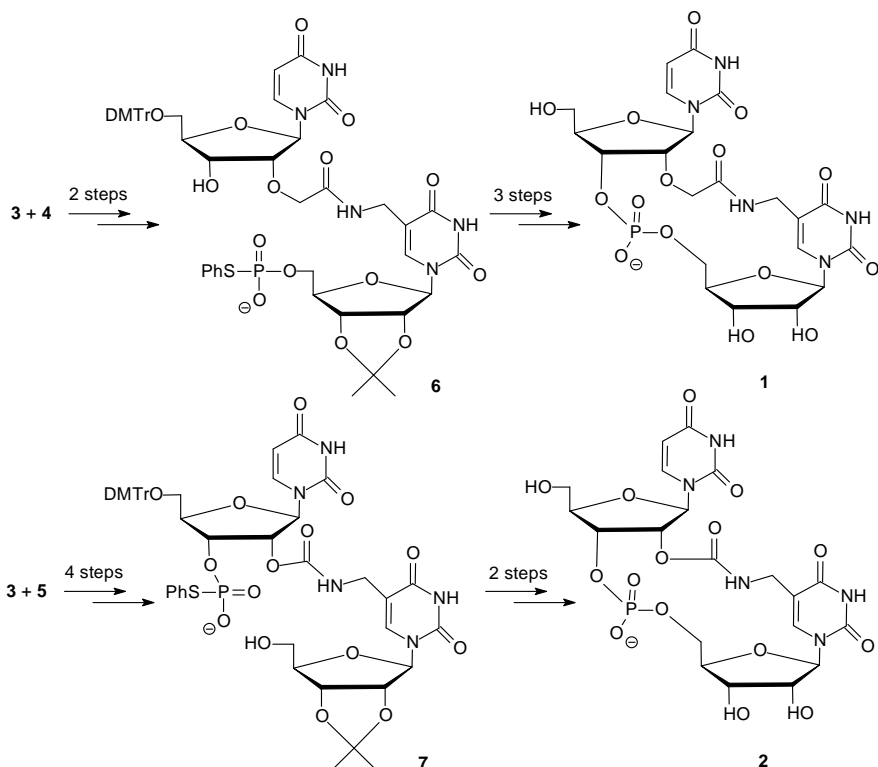

Scheme 2. Synthesis of *U*-turn mimics, amide- and carbamate linked diuridines **1** and **2**.

The carbamate-linked cyclic diuridine monophosphate **2** was obtained *via* a similar methodology than **1**. The carbamate function was generated by the nucleophilic attack of the amino function of **3** on the reactive 2'-*O*-carbonate ester **5** in good yield (89%). After a series of protection/deprotection steps of the hydroxyl functions of the acyclic dinucleotide, phosphorylation was performed on the 3'-hydroxyl function of the upstream uridine following the same procedure as described for **6** and gave the key intermediate **7**. Cyclization of the macrocyclic structure and acidic deprotection of the hydroxyl functions gave the carbamate-linked cyclic diuridine monophosphate **2** in 21% overall yield from **3** and **5**.

Both the amide-linked and carbamate linked dimer **1** and **2**, exhibited conformational rigidity as outlined by circular dichroism experiments, in which, compared with unmodified UpU, these compounds did not showed variation of the positive Cotton effect around 270 nm. Conformational studies by means of ³¹P, ¹H NMR and molecular mechanics calculations showed that the carbamate-linked diuridine **2** stand as a better *U*-turn mimic than the amide-linked **1**. This latter compound can serves to extend the nucleic acid chain toward both the 5' and 3' directions and to induce a bend motif of duplexes. Indeed, when incorporated into oligothymidylate, the authors showed for the first time that this motif was able to induce a bent into a DNA oligomer.^{33,34}

2.2. 5'-Cyclouridylic acid and derivatives

At the same time, the Sekine's group has developed intramolecularly cyclized nucleosides with the aim to obtain derivatives having an *N*-type sugar conformation. They choose, for that special purpose, to prepare

5'-cyclouridylic acids by introducing a bridge between the 5'-phosphate group and the 5-C position of the uracil moiety (Figure 7).³⁵

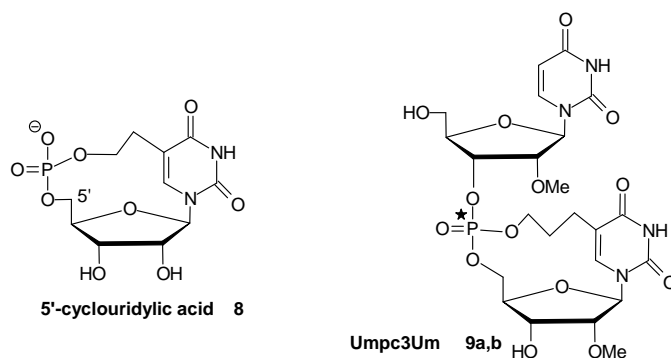
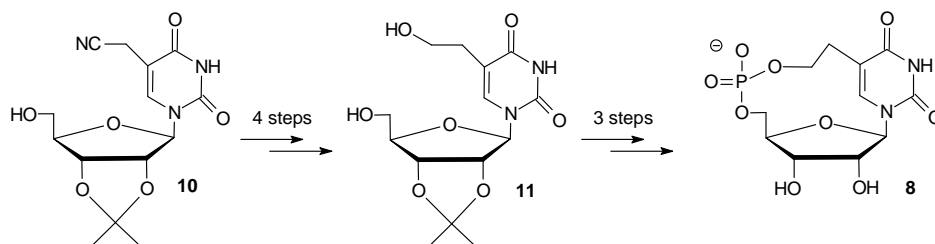

Figure 7. 5'-Cyclouridylic acids and derivatives.

To synthesize the 5'-cyclouridylic acid **8**, the authors employed 5-(cyanomethyl)-2',3'-*O*-isopropylideneuridine **10** as starting material (Scheme 3).³⁶ After protection of the primary hydroxyl function, the cyano group was converted into an hydroxyl function by an NaOH mediated hydrolysis followed by a borane reduction of the formed carboxylic acid. After release of the 5'-*O*-hydroxyl group, 5-(hydroxyethyl)-uridine **11** was obtained in 36% overall yield. The two hydroxyl functions were then reacted with bis(diisopropylamino)(2-cyanoethoxy)phosphine to build the 12-membered ring phosphotriester. Successive oxidation of the phosphine, followed by removal of the phosphate and hydroxyl protective groups gave 5'-cyclouridylic acid **8** in 22% overall yield from **10**.



Scheme 3. Synthesis of 5'-cyclouridylic acid **8**.

The study of the conformational property of **8** demonstrated that the sugar puckering equilibrium was displaced in favour of the N-type conformer and that this cyclic uridylic acid should be useful as a rigid model of A-form nucleotides. Further experiments showed that replacing the ethyl bridge by a propyl increased the C3'-*endo* conformation population to a larger extend and when incorporated at 5'-terminal site of an oligothymidilate considerably contribute to the stabilization of A-type duplexes.³⁷

They also retain this structure of cyclouridylic acid to build diuridine motif such as Umpe3Um **9** (Figure 7) in order to provide new tools to induce distorted nucleic acids structures.³³

The hydroxypropyl chain at the 5 position of the uridine was introduced on 5-iodouridine by palladium catalyzed displacement of iodine with propargyl alcohol followed by an hydrogenation of the triple bond. The 5-iodouridine was obtained from suitably protected 2'-*O*-methyluridine by action of ICl (Scheme 4). 5-(Hydroxypropyl)uridine **12** was then obtained in 36% overall yield. Interestingly, the 13-membered

macrocyclic diuridine was prepared without using any techniques such as the high dilution method by reacting **12** with the di(diisopropylamino)phosphite of the 5'-*O*-dimethoxytrityl-2'-*O*-methyluridine in 80% yield. Removal of the 3'-*O*-acetyl protective group gave the opportunity to separate the two diastereoisomers that were independently deprotected in acidic medium to provide **9a,b**.

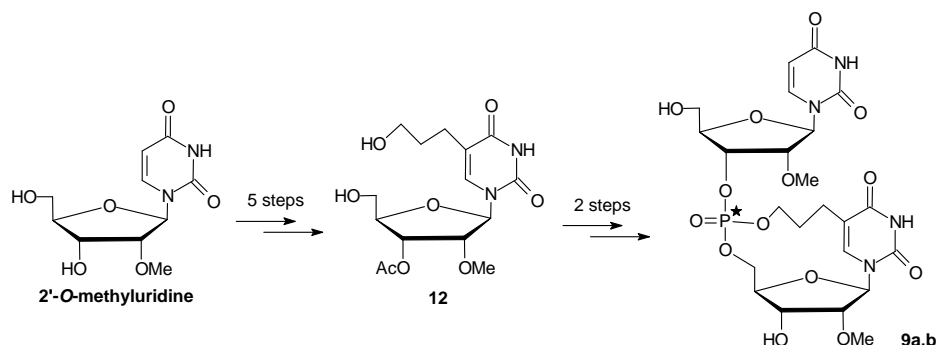

Scheme 4. Synthesis of the diastereoisomeric diuridine **9a,b** incorporating a cyclouridylic acid motif.

Conformational analysis of **9a,b** involving a cyclic phosphotriester structure showed that due to the neutral phosphoryl moiety, the conformation of the ribose of the 5'-upstream uridine was strongly affected and was maintained predominantly in the *C2'-endo* (South or B-type) conformation whereas the ribose moiety of 3'-downstream uridine was kept in the original *C3'-endo* (North or A-type). Therefore, these ribodinucleotides exhibit a South/North junction that is observed in yeast tRNA^{Phe} sharply bent motif as the authors have observed by a careful examination of the protein data bank.

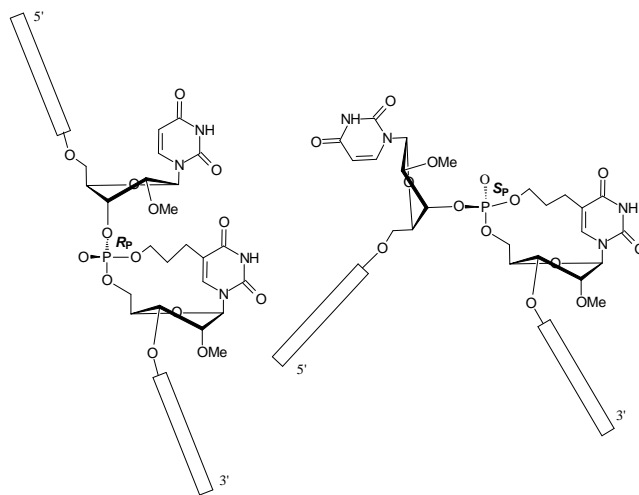

Figure 8. Schematic drawing of oligonucleotides incorporating *R_P* or *S_P* configured rigid cyclouridylic acid derivative.

When incorporated into oligothymidilates both **9a** and **9b** induced a decrease of the overall stability of the duplex formed with complementary oligoadenylate with a significantly more pronounced impact of the *S_P* configured dimer. Molecular mechanics calculations indicated that the *R_P* configured diuridine could be capable of duplex formation with a disordered local structure whereas the *S_P* isomer, which is rather unfavourable for the duplex formation, could be a very good motif to induce a strong bended structure into nucleic acids (Figure 8).

2.3. Synthesis of cyclic di- and trinucleotide by Ring Closure Metathesis (RCM)

Latter on, the Poul Nielsen's group showed that the ring-closing metathesis (RCM) method was suitable in the construction of conformationally restricted dinucleotide structures. They develop this methodology to prepare targeted nucleosidic structures as new tools to preorganize a single stranded nucleic acid either to form stabilized duplexes or to induce stabilization in others secondary structures. They first, demonstrated the introduction of isolated conformational restriction to the intact phosphodiester linkage by the synthesis of cyclophosphate dinucleotides **13** in which α and β torsional angles are constrained (Figure 9).^{38,39} After that, they extended the methodology to the preparation of cyclouridilic acids derivatives **14**,⁴⁰ **15**^{41,42} constraining α , β , γ and ϵ, ζ torsional angle sets respectively, and to macrocyclic diphosphotriester trinucleotide compounds **16** in which the whole set of torsional angle is restrained.⁴³ As it can be easily observed, all these compounds present new chiral centres either at the phosphorus atom or at the sugar carbon involved in the cyclic structure. Therefore, they were synthesized as mixture of diastereoisomers and separated.

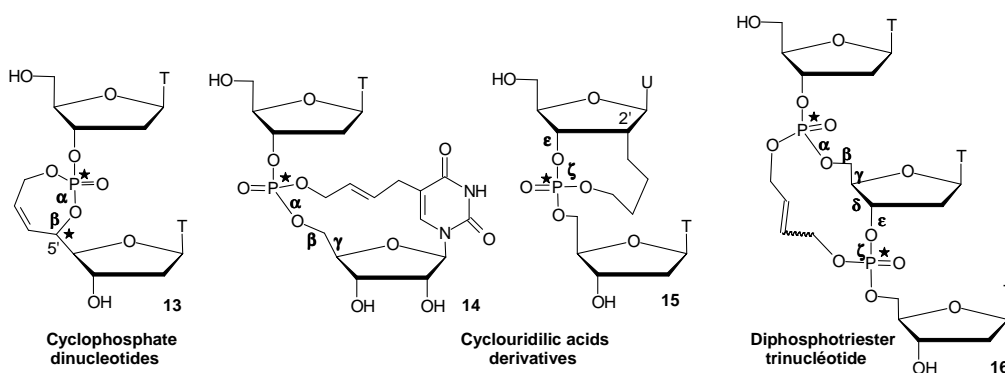
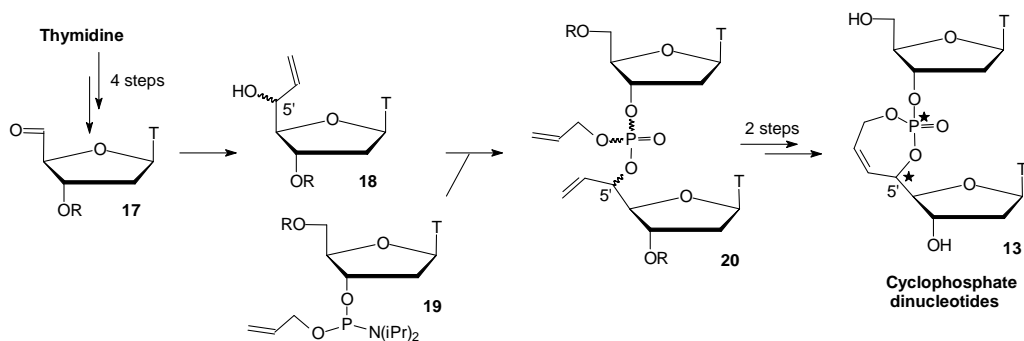

Figure 9. Cyclophosphotriester obtained by ring-closing metathesis reaction.

Their general methodology is based on the synthesis of dinucleotide units (or trinucleotide units) with a phosphotriester linkage in which the classical cyanoethyl phosphate protective group has been replaced by an allyl group. On the other hand, another double bond has to be introduced at the appropriate location on one of the nucleoside either on the sugar or on the base moiety to provide the substrate for the Ring-Closing Metathesis reaction.⁴⁴

As a first example, the Nielsen's group prepared a conformationally restricted dinucleotide with the smallest possible ring (7-membered) including a phosphotriester group (Scheme 5).³⁸ Starting from the thymidine aldehyde **17**, that can be easily prepared from thymidine in a four steps procedure using either the Pfitzner-Moffat⁴⁵ or Dess-Martin⁴⁶ oxidation procedure, the first double bond was introduced through a Grignard reaction with vinyl magnesium bromide in a moderate 41% yield to give **18** in a 1:1 diastereoisomeric ratio. The dinucleotide precursor **20** was synthesized from **18** by coupling with the known allyl phosphoramidite **19**⁴⁷ using standard phosphoramidite coupling conditions.⁴⁸ After oxidation **20** was obtained in 87% yield as a mixture of four diastereoisomers in equimolecular ratio. The RCM reaction with **20** as the substrate proceeded nicely when using the second generation Grubbs' catalyst^{49,50} in a very good 91% yield.



Scheme 5. Synthesis of diastereoisomeric cyclophosphate dinucleotides.

NMR studies in combination with restrained molecular dynamics simulations showed that at least one out of the four diastereoisomers including the seven membered phosphepine ring in the inter-nucleoside linkage was found to favour base stacking and therefore could be a good candidate to stabilize duplexes.

The backbone angles measured for the others isomers showed an increased deviation from the canonical values.⁴²

The RCM methodology was applied to the preparation of cyclouridilic acid derivative introduced by Sekine few years before (Scheme 6).^{40,43} Starting from uridine, an allyl group was appended at the 5-position of the uracil base⁵¹ and the secondary hydroxyl functions protected as an acetal to provide **21** in 65% overall yield. The allyl phosphoramidite **19** was then coupled in a quantitative manner to afford after oxidation of the phosphite the RCM substrate dinucleotide **22** as a mixture of two epimers. Approximately 5 mol% of 1,3-dimesityl-4,5-dihydroimidazol-2-ylidene-substituted ruthenium-based complex⁴⁹ was used for this RCM reaction affording the cyclouridilic acid derivative with a the 14-membered ring structure in 43% yield. After acidic deprotection of all the hydroxyl function, the dinucleotides **14** were recovered as a mixture of four isomers in a 10:10:1:1 ratio. The two major isomers were supposed to be those with *E*-configuration of the double bond and with epimeric phosphorous.

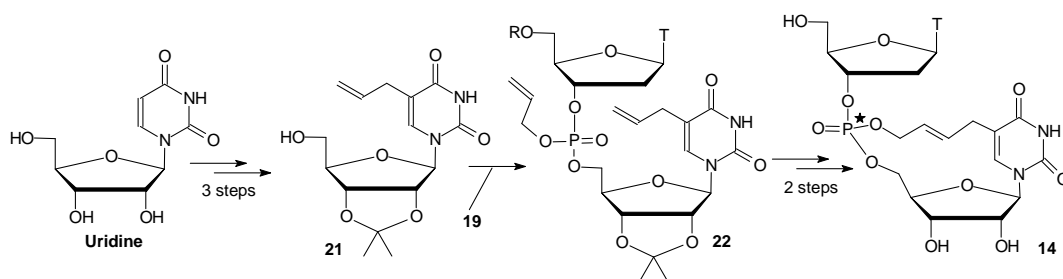

Scheme 6. Synthesis by ring-closing metathesis procedure of the Sekine's cyclouridilic acid derivative.

The last phosphotriester constrained dinucleotide structure investigated by the Nielsen's group involved a connection between the 2'-carbon and the phosphate (Scheme 7). The dinucleotide **25** suitably functionalized to undergo the RCM reaction was constructed in 85% yield from the previously published 2'-allyl-2'-deoxyuridine **23**,⁵² by coupling with the 5'-*O*-allylphosphoramidite **24** under standard phosphoramidite conditions. The application of a tandem RCM-hydrogenation protocol⁵³ with **25** as substrate and with the second generation Grubbs' catalyst gave the saturated 9-membered ring

phosphotriester structure **15** in 65% yield after deprotection of the hydroxyl function, as a mixture of two phosphorus epimers in a 3:1 ratio in favour of the R_P isomer.

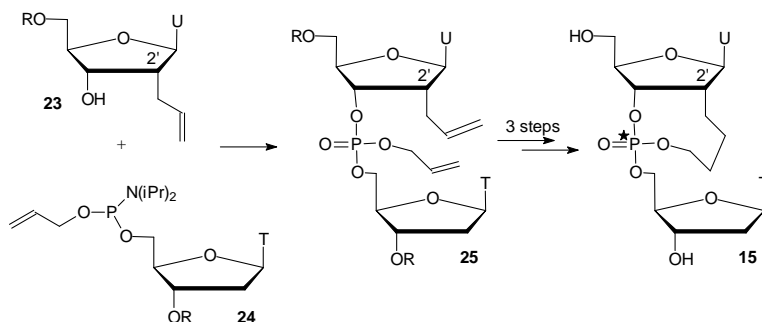

Scheme 7. Synthesis by ring-closing metathesis procedure of a 2'-C to 3'-O-phosphate cyclophosphate dinucleotide.

Finally, this group demonstrated that large macrocycle including all the torsional angle α to ζ can be reached by the RCM methodology as exemplified by the synthesis of a trinucleotide **16** in which two adjacent phosphate groups are connected (Scheme 8).⁴³ Thus the bisallylated trinucleotide **27**, substrate for the RCM reaction was elaborated in 63% yield by two phosphoramidite coupling of the allyl phosphoramidite **19** starting from the 3'-O-protected thymidine **26**. The RCM reaction have been carried out in refluxing dichloromethane for 48 hours with 10 mol% of second generation Grubbs' catalyst and provided the 13-membered rings containing trinucleotides **16** in 60% yield as a mixture of isomers arising from the two chiral phosphotriesters in combination with *E*- and *Z*-configuration of the double bond.

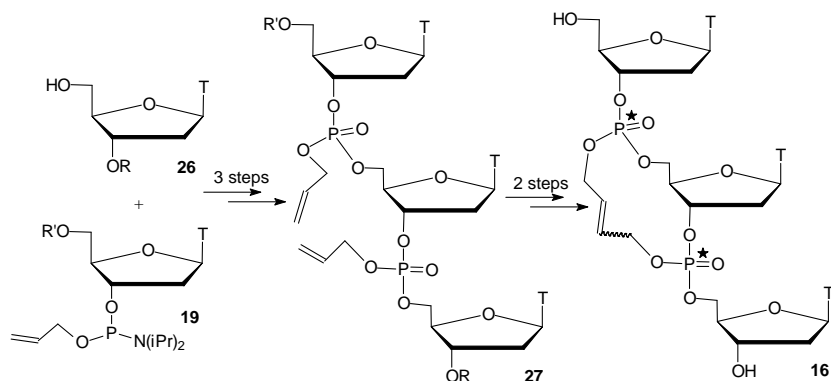

Scheme 8. Synthesis by ring-closing metathesis procedure of trinucleotide diphosphotriester.

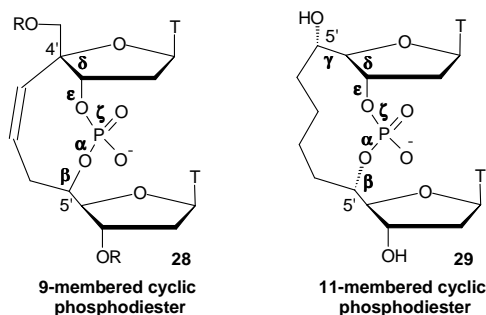
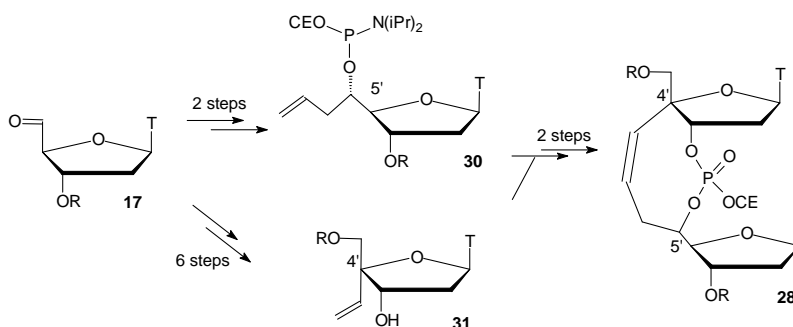

Figure 10. Cyclic dinucleotide phosphodiester obtained by ring-closing metathesis reaction.

In order to obtain constrained cyclic dinucleotides with an intact, charged and achiral, phosphate internucleoside linkage (Figure 10), the Nielsen's group approached couplings of nucleoside monomers on which terminal double bonds are placed either on the 4'-C or on the 5'-C positions and involved these dinucleotides in RCM-reactions.^{54,55}

Thymidine aldehyde **17** was the starting material for the elaboration of the key synthons for the construction of the 9-membered cyclic phosphodiester (4'-C/5'-C connected) **28** and for the 11-membered cyclic phosphodiester (5'-C/5'-C connected) **29**. Phosphoramidite **30** (Scheme 9) was prepared by phosphorylation with dicyanoimidazole as the activating agent⁵⁶ in 77% yield of 5'-C-allylthymidine obtained in a complete diastereoselective manner (85% yield) by a Sakurai's reaction on **17**.⁵⁷ 4'-C-Vinylthymidine **31** was synthesized from **17** after conversion of the latter compound into 4'-C-hydroxymethylthymidine,⁵⁸ protecting group manipulation and Dess-Martin oxidation of the 5''-hydroxyl function followed by a Wittig methylenation in six steps and in a 19% overall yield after removal of the 3'-O-protective group. Thus, the nucleosides **30** and **31** were coupled using standard phosphoramidite coupling conditions in a good 89% yield. RCM cyclization of this dinucleotide did proceed to give after 5 days in dichloromethane at 80 °C with 15 mol% of catalyst, one major product **28** as well as smaller amount of the others isomers, in 38% yield.



Scheme 9. Synthesis of 4'-C/5'-C connected dinucleotides.

11-Membered cyclic phosphodiester 5'-C/5'-C connected dinucleoside **29** was prepared from 5'-O-phosphite-5'-C-allyl-3'-O-protectedthymidine **30** and 5'-C-allyl-3'-O-protectedthymidine **32** (Scheme 10).⁵⁵ Phosphoramidite coupling did proceed in 63% yield after careful choice of 5'-O-protective group to ensure solubility of **32**. The following RCM reaction using Grubbs' 2nd generation catalyst (7 mol%) provided the unsaturated dinucleotide in 74% yield. The resulting cyclic dinucleotide required the removal of the 5'-O-di-methoxytrityl protective before being hydrogenated under high pressure (1000 psi) in a moderate 63% yield. Finally, fluoride deprotection of the 3'-hydroxyl function, followed by treatment with saturated ammonia gave the desired constrained dinucleotide **29** as a single isomer.

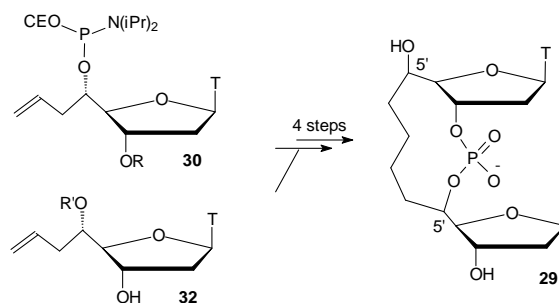

Scheme 10. Synthesis of 5'-C/5'-C connected dinucleotides.

Most of the modified dinucleotide structures synthesized by the Nielsen's group have been evaluated as parts in duplex and some of them in different secondary structures such as bulged duplex and three-way junction with both DNA and RNA complements (Figure 11).^{41,55}

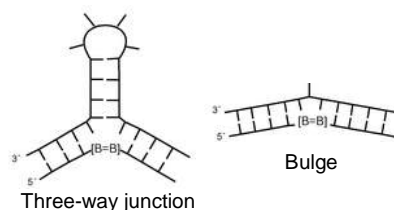

Figure 11. Evaluated secondary nucleic acid structures for stabilization.

Whereas all the constrained dinucleotide structures evaluated in duplex context showed destabilizing behaviour, **29** was found to slightly stabilise a three-way junction in high Mg^{2+} -concentrations (+0.5 °C) and the R_P isomer of **15** provided the first example of stabilized three-way junction, especially with stem-loop sequence being RNA with an increase stability of +2.2 °C rising to 2.7 °C with the addition of Mg^{2+} .

Therefore, the general RCM-based strategy for the synthesis of mimics and stabilizing units of nucleic acid secondary structures stands for a highly valuable approach.

3. Dioxaphosphorinane-Constrained Nucleic Acid

The previously described approaches towards the synthesis of conformationally constrained nucleic acids rely on the preparation of macrocyclic structures and as a consequence the conformation of such molecules are not well defined and relatively flexible due to the lack of rigidity of cycles larger than 6-membered ring.

For the purpose of constructing covalently constrained nucleic acids (CNA) with specific canonical or noncanonical backbone conformations, we have developed dimeric building units, referred to as D-CNA, in which two or three backbone torsion angles α - ζ are part of a six-membered ring structure at key position along the sugar-phosphate backbone (Figure 12).

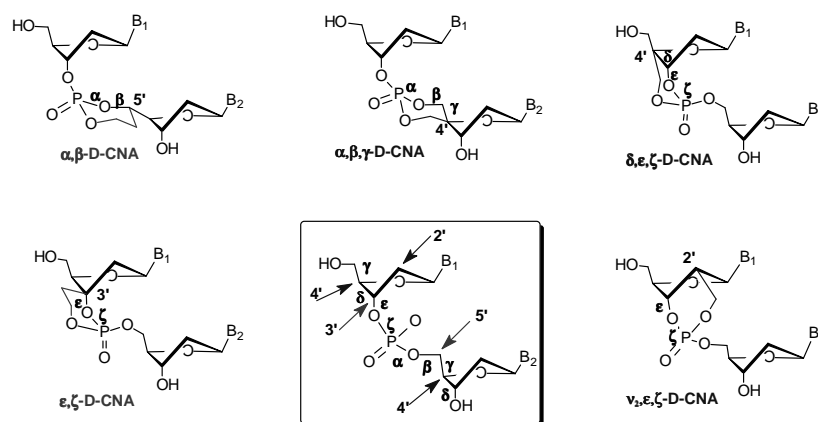

Figure 12. The Dioxaphosphorinane-Constrained Nucleic Acid family (D-CNA).

D-CNA are oligonucleotides that contain one or more D-CNA dimer in which a set of backbone torsion angles α - ζ is stereocontrolled to canonical or noncanonical values by a 1,3,2-dioxaphosphorinane ring structure. For a given dinucleotide step, there are fourteen possible [β -D-deoxyribo]-configured D-CNA stereoisomers which formally result from the introduction of a methylene/ethylene linker between the nonbridging phosphate oxygens and the 2'/4'-carbons (methylene linker, blue arrows) or 3'/5'-carbons (ethylene linker, red arrows).

Herein, we disclose the synthesis of each member of the D-CNA family, structural parameters will be established by means of X-ray diffraction analysis or NMR and finally behaviour of α,β -D-CNA within duplex will be presented.

3.1. Diastereoselective synthesis of α,β -D-CNA

Our retrosynthetic analysis for the synthesis of the four possible stereoisomers of a given α,β -D-CNA dinucleotide step is summarized in Figure 13. It is based on the very simple strategy that consists of using both steric and anomeric effects to stereocontrol the cyclization reaction of a dinucleotide precursor in which the pro-(*R*)- and pro-(*S*)-phosphate oxyanions can attack an electrophilic tosyloxy-substituted carbon atom.

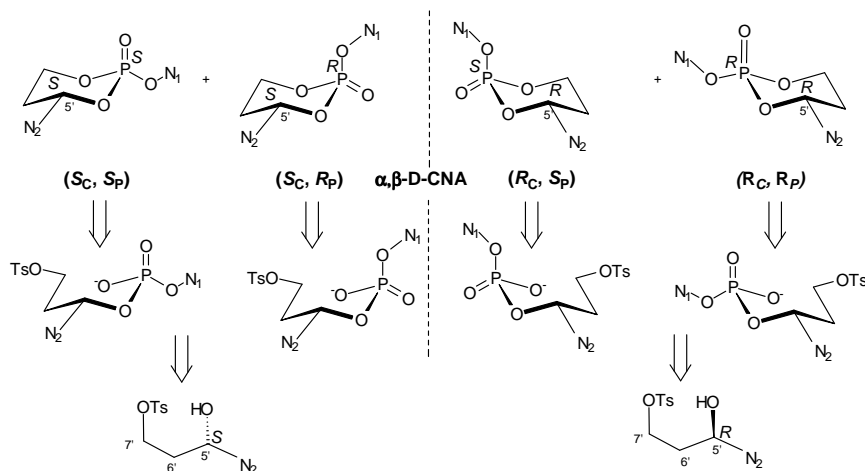
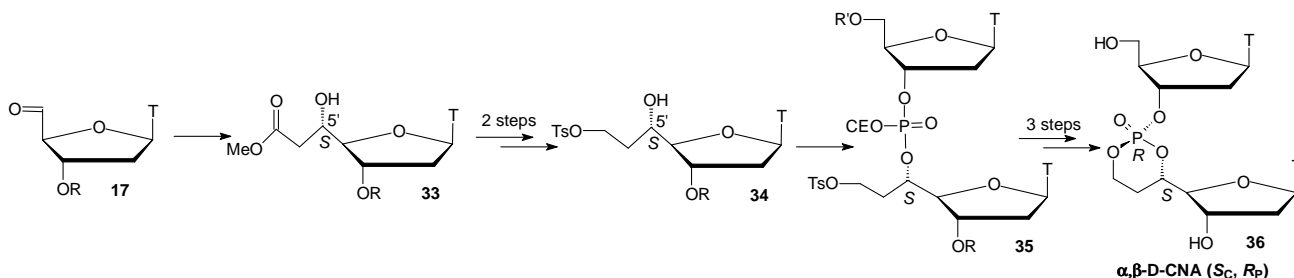

Figure 13. Retrosynthetic pathway for the diastereoselective synthesis of the four possible stereoisomers of α,β -D-CNA dimers. N_1 and N_2 stand for the remaining atomic fragments that define the upper and lower nucleoside units, respectively. The expected *gauche*(+), *gauche*(-), or *trans* conformations of α (P-O5') and β (O-C5') are indicated for the hypothetical true chair conformations associated with each diastereoisomer.

Among the four possible α,β -D-CNA diastereoisomers, we anticipated that the ($S_{C5'}$, R_P)- and ($R_{C5'}$, S_P)-isomers with the alkoxy group ON_1 axial (equatorial P=O)⁵⁹ and the carbon group N_2 equatorial would be formed preferentially due to the sterically and anomericly favorable *trans* relationship between ON_1 and N_2 in the corresponding six-membered chair conformations. As shown in Figure 11, the key starting material for the preparation of this diastereoisomer is the diastereopure 5'(*S*)-*C*-tosyloxyethyl-substituted nucleoside. Similarly, the preparation of the ($R_{C5'}$, S_P)-stereoisomer featuring the canonical { $\alpha(g^-)$, $\beta(t)$ } conformation requires the preparation of the 5'(*R*)-*C*-tosyloxyethyl-substituted nucleoside.

We first reported on the diastereoselective synthesis of α,β -D-CNA (S_C , R_P) **36** that represented the very first example of totally stereoselective preparation of a phosphotriester.⁶⁰

The corresponding precursor 5'(*S*)-*C*-tosyloxyethylthymidine **34** was prepared from the diastereopure compound **33** in 77% yield after reduction of the ester function with sodium borohydride and selective tosylation of the resulting primary hydroxyl function (Scheme 11). The 5'-*C*-methyl ester thymidine derivative **33** was obtained from the 5'-*C*-thymidine aldehyde **17** via a Mukayama's reaction catalyzed by BiCl₃/ZnI₂⁶¹ as a single isomer with a (*S*)-configuration at the newly created asymmetric centre 5'-*C* in 90% yield.⁶²



Scheme 11. Diastereoselective synthesis of α,β -D-CNA (S_C , R_P) dinucleotide.

The 5'(*S*)-*C*-tosyloxyethylthymidine **34** was coupled with the commercially available thymidine phosphoramidite under standard phosphoramidite procedure to give the acyclic dinucleotide **35** in 89% yield after the oxidation step. The cyclization reaction occurred by treatment of **35** with triethylamine in dry dimethylformamide at 90 °C, to provide, after removal of the protective groups, a single diastereoisomer α,β -D-CNA (S_C , R_P) **36** in 72% overall yield from **34**.

The preparation of the $R_{C5'}$ stereoisomers of the α,β -D-CNA requires the preparation of the corresponding 5'(*R*)-*C*-tosyloxyethylthymidine **38** (Scheme 12).⁶³ Our synthesis of compound **38** involves the preparation of the diastereopure 5'(*R*)-*C*-hydroxyethyl thymidine. The latter compound was obtained in 64% combined yield via a three-step oxidative cleavage procedure of the double bond of the available 5'(*R*)-*C*-hydroxypentenyl thymidine **37** prepared by a Sakurai's allylation reaction of the 5'-*C*-thymidine aldehyde.⁶⁴ Selective tosylation of the primary hydroxyl function was achieved in 77% yield by reaction with tosyl chloride in the presence of pyridine.⁶⁵ 5'(*R*)-*C*-Tosyloxyethylthymidine **38** was then coupled with the commercially available thymidine phosphoramidite using standard phosphoramidite technology to give two diastereoisomeric dinucleotides in an equimolar ratio. In the reaction conditions used to release the charged phosphodiester function of **4** (Et₃N, DMF, 90 °C), cyclization occurred in a 90% yield providing a 7/3 diastereoisomeric mixture of the ($R_{C5'}$, S_P) and ($R_{C5'}$, R_P) diastereoisomers, as observed by ³¹P NMR (δ_P -9.1 and -5.9). The cyclization reaction from the 5'(*R*)-configured acyclic phosphate precursor (de 70%) appears therefore less diastereoselective than that previously observed from the corresponding 5'(*S*)-isomer (de 100%). Finally, the sequential removal of the protective groups using fluoride ion and trifluoroacetic acid provided the final compounds ($R_{C5'}$, S_P) **40** and ($R_{C5'}$, R_P) **41** in ca. 21% and 9% overall yields from **37**, respectively.

The determination of the absolute configuration of the α,β -D-CNA was greatly simplified by the X-ray structure solved for **40** identified as the ($R_{C5'}$, S_P) diastereoisomer.

Although the synthetic pathway of Scheme 12 gives access to the diastereopure 5'(*R*)-*C*-tosyloxyethylthymidine **38** in almost 50% yield from **37**, the overall yield from the starting 5'-*C*-thymidine aldehyde **17** is rather low (25%). In an attempt to increase the overall yield of **38** and to prepare all

accessible diastereoisomers of the α,β -D-CNA dimers in a one pot procedure, we opted for a more pragmatic strategy which takes advantage of the easier accessibility of the 5'-epimer of **38** (the latter compound, referred to as **34** in Scheme 11, is obtained from the starting aldehyde in *ca.* 70% overall yield). Oxidation of the 5'-hydroxyl function of **34** with the pyridinium dichromate reagent immediately followed by the reduction of the corresponding ketone (with NaBH₄) gave a 4/6 diastereoisomeric mixture of **34** and **38**, respectively, in 90% combined yield.

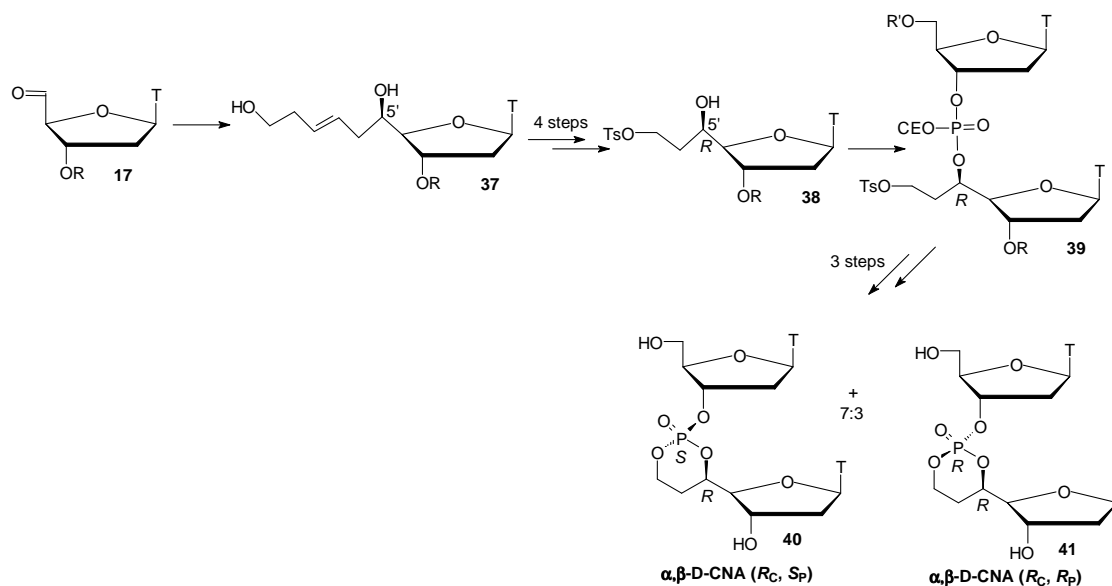

Scheme 12. Synthesis of the (R_C, S_P) and (R_C, R_P) α,β -D-CNA diastereoisomers.

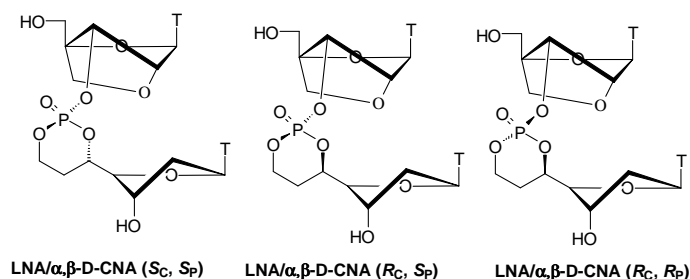

Figure 14. Synthesized diastereoisomers of LNA/ α,β -D-CNA dinucleotides.

This strategy was extended to prepare α,β -D-CNAs with all the four possible nucleosides (A, T, G and C) as upper nucleoside and also the LNA/ α,β -D-CNAs with a LNA structure on the upper nucleoside (Figure 14).⁶⁶

3.2. Synthesis of α,β,γ -D-CNA and δ,ϵ,ζ -D-CNA

As described in Figure 12, depending on the dioxaphosphorinane ring position along the sugar-phosphate backbone different set of torsional angles can be controlled. In this section, we will describe the D-CNA obtained when connecting the phosphate group to the 4'-carbon either of the upper or the lower nucleoside of the dinucleotide unit, providing constraints on the α,β,γ or δ,ϵ,ζ torsional angles.⁶⁷

For the synthesis of α,β,γ -D-CNA, the dioxaphosphorinane ring structure was introduced as previously described, *i.e.* from the cyclization reaction of a dinucleotide precursor in which the phosphate oxyanions

can attack an electrophilic tosyloxy-substituted carbon atom (Scheme 13). The corresponding acyclic precursor involved is the diastereoisomeric 4'-substituted dithymidine **43** prepared by coupling 5'-*O*-tosyl-4'-*C*-hydroxymethylthymidine with the commercially available thymidine phosphoramidite using standard phosphoramidite technology in 80% yield. 5'-*O*-Tosyl-4'-*C*-hydroxymethyl modified thymidine has been obtained in three steps by treatment of 4'-*C*-hydroxymethyl-thymidine **42**, first with dimethoxytrityl chloride and then with tosyl chloride in the presence of pyridine followed by the removal (with trifluoroacetic acid) of the dimethoxytrityl group selectively introduced on the 5''-hydroxyl function, in 63% overall yield.

By treatment with K_2CO_3 in dry dimethylformamide at 90 °C for 2 h, **43** quantitatively cyclized into the *cis* and *trans* isomers of phosphotriester in a 2:1 ratio as observed by ^{31}P NMR (δ_P -9.6 and -7.8 ppm), respectively. Removal of the silyl protective group with fluoride ion provided the corresponding mixture of *cis* and *trans* isomers, which were separated at this stage. Finally, α,β,γ -D-CNA *cis* **44** and *trans* **45** were obtained upon removal of the remaining dimethoxytrityl protective group in acidic conditions in 28 and 14% yield from **42**, respectively.

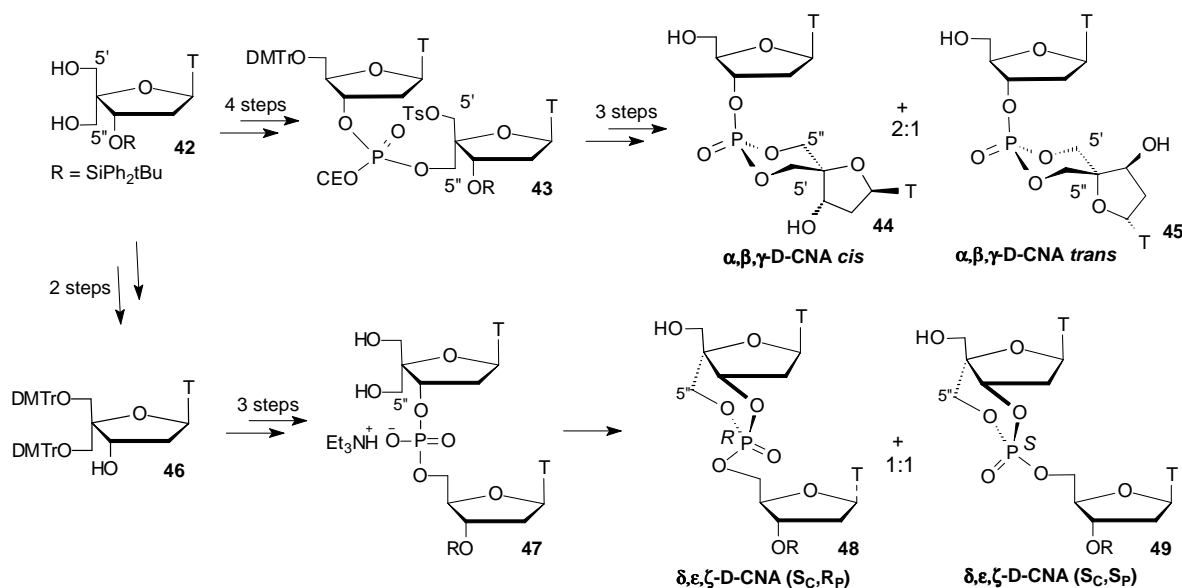

Scheme 13. Synthesis of α,δ,γ - and δ,ϵ,ζ -D-CNA from 4'-*C*-hydroxymethyl thymidine.

Because of the poor yield obtained for the selective introduction of the tosyl group at the 5''-position of the 4'-*C*-hydroxymethyl-thymidine **42**, we decided to take advantage of the greater reactivity of the 5''-hydroxyl function later on the synthetic pathway of the δ,ϵ,ζ -D-CNA, *i.e.* right at the cyclization step producing the dioxaphosphorinane structure (dinucleotides **48/49** in Scheme 13). Thus, we applied the well known phosphotriester methodology⁶⁸ in the presence of the 1-(mesitylene-2-sulfonyl)-3-nitro-1,2,4-triazole (MSNT) as an activating agent^{69,70} to quantitatively prepare the (*S*_{C4'}, *R*_P) and (*S*_{C4'}, *S*_P) diastereoisomers **48** and **49**, respectively. The acyclic phosphodiester **47** was obtained in a good overall yield (80%) from starting nucleoside **42** in a five-step sequence (Scheme 13). Dimethoxytritylation of both primary hydroxyl functions of **42** followed by desilylation of the O3' oxygen atom (with tetrabutylammonium fluoride) gave nucleoside **46** in a high 85% combined yield. After coupling **46** with a thymidine bearing a phosphoramidite function at the 5' position, both dimethoxytrityl groups were removed under acidic conditions to give an expected 1/1

diastereoisomeric mixture. The negatively charged phosphodiester was released by treatment with triethylamine, producing the acyclic precursor **47** which, in the presence of MSNT in hot pyridine, quantitatively cyclized into the 1/1 diastereoisomeric mixture of **48** and **49** as observed by ^{31}P NMR ($\delta_{\text{P}} = -2.3$ and -3.8 ppm).

That the dioxaphosphorinane ring was actually formed by reaction of the 5''-hydroxyl group was shown by the X-ray structure solved for **49** that also gave us the absolute configuration at the newly created asymmetric centres 4'-C and P of δ, ϵ, ζ -D-CNA **48** and **49**.

3.3. Nucleosidic and sugar based approach towards ϵ, ζ -D-CNA

In order to enlarge the ϵ/ζ set combination, and therefore to have access to an increase variety of structures, we choose to introduce the dioxaphosphorinane ring by connecting the 3'-C (by an ethylene bridge) or the 2'-C (by a methylene bridge) to the oxygen atom of the phosphate group, providing ϵ, ζ -D-CNA and ν_2, ϵ, ζ -D-CNA, respectively (Figure 10).

The first approach, by introduction of an ethylene bridge between the 3'-carbon and one oxygen of the phosphate group, generate a spiro structure with four diastereoisomers expected. We actually reported the synthesis of diastereoisomers with 3'-C (S) configuration termed as *xylo*, ϵ, ζ -D-CNAs (Scheme 14).⁷¹

The synthesis in 50% yield of the key intermediate 3'-C-(methoxycarbonylmethyl)xylouridine **51** involves the stereoselective Mukaiyama's addition of the *tert*-butyldimethylsilyl-methyl-ketene acetal⁷² on the keto-uridine obtained from the known 2',5'-di-*O*-*tert*-butyldimethylsilyl uridine **50**⁷³ by Dess-Martin oxidation procedure. We chose to start from the keto-uridine instead of the obvious keto-thymidine analogue because the latter is prone to base elimination in basic and in acidic conditions due to the high acidic character of the 2'-protons.

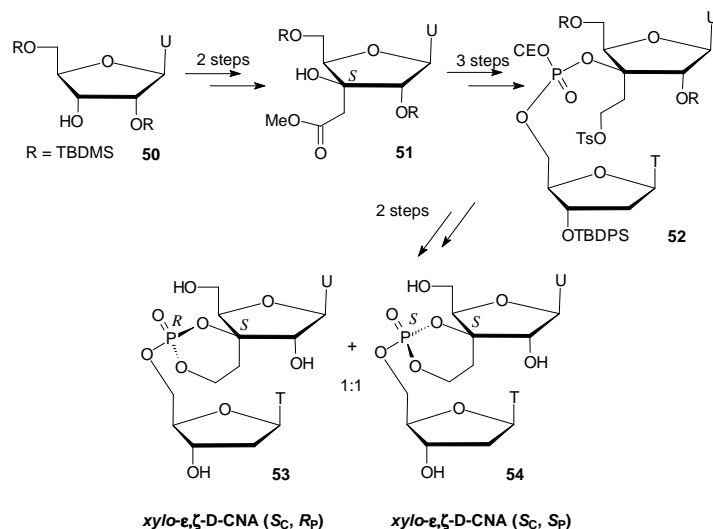

Scheme 14. Synthesis of spiro *xylo*- ϵ, ζ -D-CNA diastereoisomers.

The ester function of **51** was then reduced by the diisobutylaluminium hydride in a moderate 46% yield before selective introduction of a tosyl group on newly generate primary hydroxyl function in 64% yield. This 3'-C-substituted nucleoside was then coupled with the readily available 3'-*O*-*tert*-butyldiphenylsilyl-5'-*O*-phosphoramidite thymidine according to standard phosphoramidite procedure to give

two diastereoisomeric dinucleotides **52** in an equimolar ratio and in 64% yield. *Xylo-ε,ζ-D-CNA* **53** and **54** were obtained as a mixture of diastereoisomers (1/1 ratio as depicted by ^{31}P NMR: $\delta_{\text{P}} = -6.4$ and -8.9 ppm), in good yield (81%) by treatment of **52** with K_2CO_3 in anhydrous dimethylformamide at room temperature followed by removal of the silylated protective groups with fluoride ion. In this particular case, no diastereoselectivity was observed certainly because the substitution on 4'-C and 2'-C are sterically equivalent and therefore there is no discrimination in the transition state to favour one dioxaphosphorinane diastereoisomer. Because of the spiro structure with a "S" configuration of 3'-C between the upper sugar ring and the dioxaphosphorinane cycle, the relative position of the 2'-hydroxyl function with respect to the phosphorus atom does not allow any trans-esterification process since the favourable "on line" conformation can not be reached.⁷⁴ This particular conformation provide a stable phosphotriester function regardless of the presence of the usually reactive free 2'-hydroxyl function.

Regarding the synthesis of ν_2, ϵ, ζ -D-CNA, we have to introduce a hydroxymethyl function at the 2'-position.⁷⁵ A survey of the literature, showed that a nice precursor for our purpose could be the protected 2-deoxy-2-hydroxymethyl-D-ribofuranose **55** prepared from D-glucose⁷⁶ (Scheme 15) that offer us the opportunity to have a key synthon for the preparation of all the 2'-C-hydroxymethyl nucleosides (A, T, G or C).

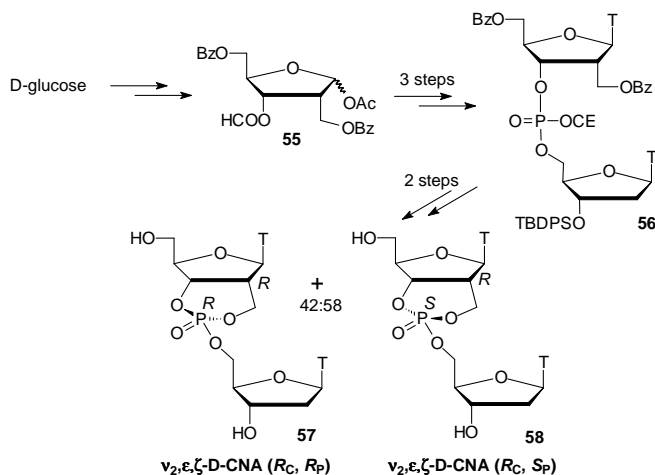

Scheme 15. Synthesis of ν_2, ϵ, ζ -D-CNA from D-glucose.

Introduction of the thymine base by the Vorbrüggen's procedure⁷⁷ proceeds in a moderate 56% yield in favor of the β -anomer ($\beta/\alpha=9/1$ as depicted by ^1H NMR) as expected for 3-O-formyl-ribose **55** (Scheme 15). This could be explained by the fact that the 2'-benzoyloxymethyl group is less efficient in the stabilization of the intermediate carbocation and therefore allow a small level of undesirable α -face attack. The 3'-hydroxyl function was released by treatment of the intermediate nucleoside with ammonia. The resulting nucleoside was then coupled with the readily available 3'-O-*tert*-butyldiphenylsilyl-5'-O-phosphoramidite thymidine according to standard phosphoramidite procedure to give dinucleotides **56** as a diastereoisomeric mixture (1/1 ratio as depicted by ^{31}P NMR: $\delta_{\text{P}} = -1.8$ and -2.1 ppm), in 38% overall yield from **55**. Removal of the benzoyl and cyanoethyl protective groups proceeded in moderate yield (45%) and we noticed a concomitant cleavage of the 3'-O-*tert*-butyldiphenylsilyl protective group. Nevertheless, when submitted to action of 1-(mesitylene-2-sulfonyl)-3-nitro-1,2,4-triazole **56** underwent a slightly diastereoselective cyclization to

provide the $\nu_{2,\epsilon,\zeta}$ -D-CNA **57** and **58** in a 1/1.4 ratio (depicted by ^{31}P NMR: $\delta_{\text{P}} = -6.6$ and -7.8 ppm, respectively), in 60% yield.

3.4. Structural assignment of the D-CNA dimers

Each of the synthesized dinucleotide D-CNA was studied by means of X-ray diffraction analysis when accessible and by NMR in all cases. The conformation of the dioxaphosphorinane structures can be clearly established from the ^1H NMR spectra, with the observation of the $^3J_{\text{H/P}}$ coupling constants between the relevant protons and the phosphorus. Indeed, typical upper and lower limits observed for the $^3J_{\text{H/P}}$ coupling constants for dioxaphosphorinane structures in chair conformation are $^3J_{\text{Hax/P}} < ca. 3$ Hz and $^3J_{\text{Heq/P}} > ca. 20$ Hz, respectively.⁷⁸

Table 2. Summary of the backbone torsion angles derived from the canonical B_I-, A-DNA duplex structures and of the synthesized D-CNA.^a

Name	Isomer	Torsion angles					
		α	β	γ	δ	ϵ	ζ
B_I-Type		g^-	t	g^+	a^+/t	t	g^-/a^-
A-Type		g^-	t	g^+	g^+/a^+	a^-/t	g^-
α,β-D-CNA	{	(S _{C5'} , R _P)	g^+	t			
		(R _{C5'} , S _P)	g^-	t			
		(S _{C5'} , S _P)	a^-	a^+/t			
		(R _{C5'} , R _P)	a^+	a^-/t			
LNA/α,β-D-CNA	{	(S _{C5'} , S _P)	g^+	t		g^+/a^+	
		(R _{C5'} , R _P)	g^-	t		g^+/a^+	
		(R _{C5'} , S _P)	a^-	a^+/t		g^+/a^+	
α,β,γ-D-CNA	{	cis	g^-	g^-	g^-		
		trans	g^+	c/g^+	g^-/a^-		
δ,ϵ,ζ-D-CNA	{	(S _{C4'} , R _P)			a^+/t	g^-	g^-
		(S _{C4'} , S _P)			a^+/t	g^-	a^+/t
$\nu_{2,\epsilon,\zeta}$-D-CNA	{	(R _{C2'} , S _P)			a^+	g^+	g^-
		(R _{C2'} , R _P)			a^+	g^+	t
ϵ,ζ-D-CNA	{	(S _{C3'} , R _P)			c	t	g^+
		(S _{C3'} , S _P)			c	t	g^-

^aThe following 6-fold staggered pattern of the torsional angles is used: *cis* = 0–30° (*c*), *gauche*(+) = 60–30° (g^+), *anticlinal*(+) = 120–30° (a^+), *trans* = 180–30° (*t*), *anticlinal*(-) = 240–30° (a^-), *gauche*(-) = 300–30° (g^-). The notation a^+/t is used to designate a torsion angle on the border of *anticlinal*(+) and *trans*.

Therefore, by careful examination of these data, we have been able to determine the conformational behaviour of the D-CNA and therefore to precise the value of the constrained torsional angles. The conformational ranges of the torsional angles are summarized in Table 2 together with those of A- or BI-type duplex given as reference.

It is noteworthy that only one isomer of the α,β -D-CNA (and its analogue LNA/ α,β -D-CNA) fit with the canonical values observed for A- or B- type duplex. To better visualize the impact of the introduction of a constraint on the sugar-phosphate backbone by the dioxaphosphorinane structure, superimposition of the major isomers of α,β -D-CNA and of α,β,γ -D-CNA with an unmodified dinucleotide⁷⁹ are reported in Figure 15.

Whereas, the ($R_{C5'}$, S_P) α,β -D-CNA isomer perfectly fits with the unmodified structure of its dinucleotide counterpart, introducing noncanonical torsion angle values into the backbone results in an extraordinary change in the relative spatial arrangement of the bases which is nicely illustrated by the superimposition of the ($S_{C5'}$, R_P) α,β -D-CNA and both of the *cis* and *trans* α,β,γ -D-CNA with the X-ray structure of pTpT, showing that the relative orientation of the bases can be switched up to 180°.

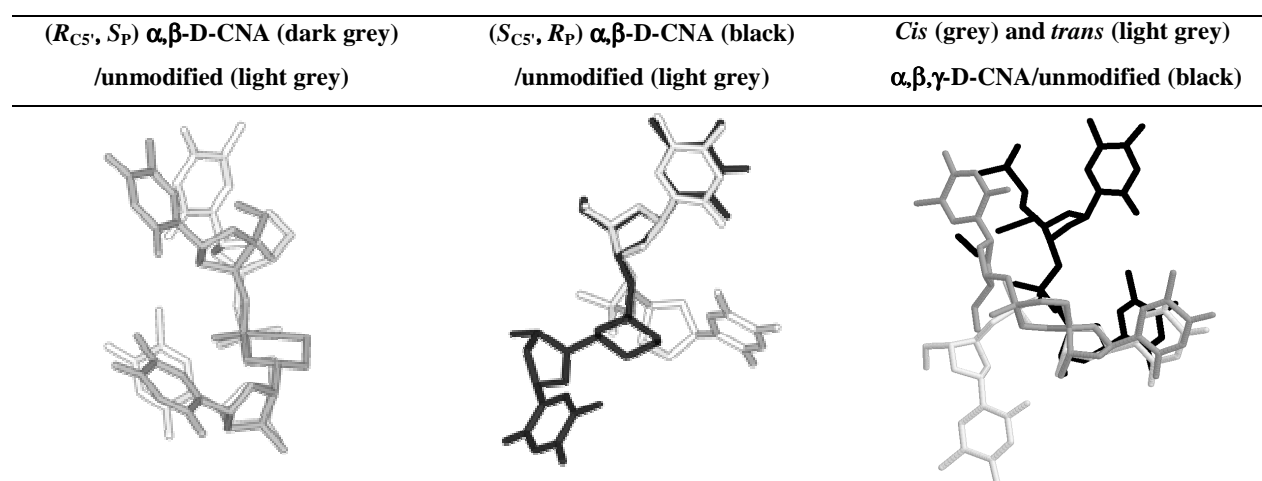

Figure 15. Examples of superimposition of D-CNA structures and X-ray structure of unmodified pTpT.⁷⁹

In most cases, the chair and twist-chair conformations of dioxaphosphorinane within D-CNA allow the stabilization of unusual conformational states, which greatly differ from the canonical (g^- , t , g^+) backbone conformation adopted by the B- and A-forms of the DNA double helix (Table 2 and Figure 15). Although a thorough analysis is required to precisely determine what structural consequences can be expected from these alternative backbone conformations, it is likely that once incorporated into DNA or RNA oligomers, D-CNA dinucleotides will either favour the formation of unpaired secondary motifs or induce a significant conformational distortion from the ideal B- or A-form helical geometry.

3.5. Preliminary results on DNA duplex stabilization

The synthesis of the phosphoramidite derivatives of ($R_{C5'}$, S_P) and ($S_{C5'}$, R_P) α,β -D-CNA featuring either canonical and noncanonical α/β combination has been realized and hybridizing properties of oligonucleotides containing these dimeric units evaluated.^{80,81}

The major result is that a remarkable stabilizing effect is observed against DNA ($\Delta T_m = +5.0$ °C/mod) when the canonical ($R_{C5'}$, S_P) α,β -D-CNA is introduced once or more into oligonucleotides (Figure 16). This result contrasts with the rather moderate effect observed against RNA ($\Delta T_m = +0.9$ to $+3.0$ °C/mod). This difference can originate from the reluctance of the 5'-furanose unit of the α,β -D-CNA to undergo a significant conformational change from 2'-*endo* to 3'-*endo* in the hybrid duplex DNA/RNA due to the neutral phosphotriester linkage that strongly push the 5'-thymidine moiety to adopt the C2'-*endo* conformation.⁸²

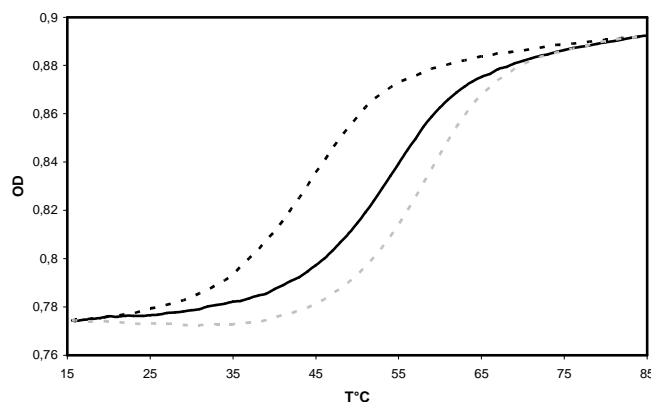

Figure 16. Thermal denaturation curves, for 3'-d(CGCGAACGGC) with unmodified 5'-d(GCGCTTGCCG) **black**, or with 5'-d(GCGCTTGCCG) including ($R_{C5'}$, S_P) α,β -D-CNA **dotted grey** or ($S_{C5'}$, R_P) α,β -D-CNA **dotted black**.

On the other hand, as expected, incorporation of ($S_{C5'}$, R_P) α,β -D-CNA featuring noncanonical (*gauche*(+), *trans*) α/β combination into oligonucleotides results in an important duplex destabilization (-5.0 ° to -9.0 °C/mod). However, one must consider that controlling this torsion at about $+70^\circ$ in a duplex while maintaining a completely Watson-Crick helical structure, allows the stabilization of distorted duplexes that are only observed in DNA/protein complex.⁸³ Nevertheless, we showed that with canonical or noncanonical restriction within oligonucleotide a high level of sequence discrimination was maintained as natural duplexes do.

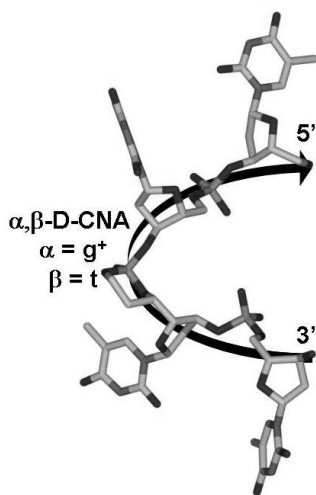

Figure 17. Tentative model derived from NMR data of the conformation of the ($S_{C5'}$, R_P) α,β -D-CNA within a T_4 tetranucleotide.

A noncanonical *gauche*(+) conformation of α seems to play an important role in many bulge and hairpin loop regions of nucleic acids.⁸⁴ Consequently we decided to explore the intimate conformation of the ($S_{C5'}$, R_P) α,β -D-CNA TT dimer and its behaviour within a single stranded tetranucleotide composed of four thymidines, a loop motif well studied in hairpin structure. We founded that when incorporated into a tetranucleotide, the α,β -D-CNA induced a sharp bent into the structure providing a hairpin loop shape to the structure of the single stranded oligonucleotide (Figure 17).⁸⁵

We therefore are disposing of a building unit featuring the noncanonical value *gauche*(+) of the α torsional angles, providing the unique opportunity to pre-organize single stranded oligonucleotide in order to explore its capability to stabilize unpaired structures of nucleic acids such as bulges or hairpin loops. As a first experiment in this direction we prepared hairpin loop structures incorporating either the ($S_{C5'}$, R_P) α,β -D-CNA in the loop moiety or the ($R_{C5'}$, S_P) α,β -D-CNA in the stem of the hairpin (Figure 18).

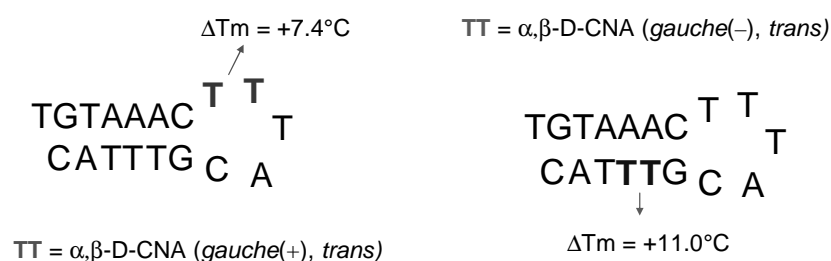

Figure 18. α,β -D-CNA induced stabilization of a hairpin.

The α,β -D-CNA featuring the canonical (*gauche*(-), *trans*) α/β combination induced a very high stabilization of the hairpin structure with a ΔT_m of $+11.0^\circ\text{C}$ due to a magnified effect of stabilization of the stem duplex. On the other hand, for the first time, the preorganization concept is successfully applied to the stabilization of an unpaired motif of nucleic acid by incorporation of α,β -D-CNA featuring the noncanonical (*gauche*(+), *trans*) α/β combination within the loop and provided a very promising ΔT_m of $+7.4^\circ\text{C}$.

4. Conclusions

At the end of its review on DNA analogues in 2002, C. Leumann mentioned that "A large field that has not yet been tapped is the use of conformationally constrained nucleosides for the stabilization of secondary structural elements as, for example hairpin loops and bulges".¹¹

After the pioneering work of Sekine, followed by the Nielsen's approach and more recently by the Dioxaphosphorinane-Constrained Nucleic Acid development, it is now clear that the rational of using cyclic phospho di- or triester structures to induce conformationally constraints into nucleic acids, is valid.

As can be seen, all of these structures are associated with very different backbone conformations and could provide interesting tool to discriminate between the impact of sugar pucker and backbone constrains on DNA structure formation ability. The incorporation of these constrained building blocks (D-CNA or others) at preselected positions in an oligonucleotide is expected to create a remarkable variety of different shapes including helical distortions of B-DNA or non-helical secondary structures of functional DNA or RNA.

Acknowledgments

This chapter is based on Christelle Dupouy's doctoral dissertation (Université Paul Sabatier, Toulouse, France, 2007). The MENRT is gratefully acknowledged for a grant to C.D. The authors are grateful to the "Plateforme de synthèse d'oligonucléotides modifiés de l'Interface Chimie Biologie de l'ITAV" de Toulouse for providing facilities for oligonucleotides synthesis.

References

1. Belmont, P.; Constant, J.-F.; Demeunynck, M. *Chem. Soc. Rev.* **2001**, *30*, 70.
2. Antson, A. *Curr. Opin. Struct. Biol.* **2000**, *10*, 87.
3. Ennifar, E.; Yusupov, M.; Walter, P.; Marquet, R.; Ehresmann, B.; Ehresmann, C.; Dumas, P. *Structure* **1999**, *7*, 1439.
4. Tereshko, V.; Wallace, S. T.; Usman, N.; Wincott, F. E.; Egli, M. *RNA* **2001**, *7*, 405.
5. Hung, L.-W.; Holbrook, E. L.; Holbrook, S. R. *Proc. Nat. Acad. Sci. U.S.A.* **2000**, *97*, 5107.
6. Scott, W. G.; Finch, J. T.; Klug, A. *Cell* **1995**, *81*, 991.
7. Ippolito, J. A.; Steitz, T. A. *Proc. Nat. Acad. Sci. U.S.A.* **1998**, *95*, 9819.
8. Cate, J. H.; Gooding, A. R.; Podell, E.; Zhou, K.; Golden, B. L.; Szewczak, A. A.; Kundrot, C. E.; Cech, T. R.; Doudna, J. A. *Science* **1996**, *273*, 1696.
9. Várnai, P.; Djuranovic, D.; Lavery, R.; Hartmann, B. *Nucleic Acids Res.* **2002**, *30*, 5398.
10. Wengel, J. A. *Acc. Chem. Res.* **1999**, *32*, 301.
11. Leumann, C. J. *Bioorg. Med. Chem.* **2002**, *10*, 841.
12. Cobb, A. J. A. *Org. Biomol. Chem.* **2007**, *5*, 3260.
13. Petersen, M.; Bondensgaard, K.; Wengel, J.; Jacobsen, J. P. *J. Am. Chem. Soc.* **2002**, *124*, 5974.
14. Pallan, P. S.; Ittig, D.; Héroux, A.; Wawrzak, Z.; Leumann, C. J.; Egli, M. *Chem. Commun.* **2008**, 883.
15. Watson, J. D.; Crick, H. C. *Nature* **1953**, *171*, 737.
16. Wilkins, M. H. F.; Stokes, A. R.; Wilson, H. R. *Nature* **1953**, *171*, 738.
17. Franklin, R. E.; Gosling, R. G. *Nature* **1953**, *171*, 740.
18. Schneider, B.; Neidle, S.; Berman, H. M. *Biopolymers* **1997**, *42*, 113.
19. Duarte, C. M.; Pyle, A. M. *J. Mol. Biol.* **1998**, *284*, 1465.
20. Freier, S. M.; Altmann, K. H. *Nucleic Acids Res.* **1997**, *25*, 4429.
21. Stevens, S. Y.; Swanson, P. C.; Voss, E. W., Jr.; Glick, G. D. *J. Am. Chem. Soc.* **1993**, *115*, 1585.
22. Glick, G. D. *Biopolymers* **1998**, *48*, 83.
23. Renneberg, D.; Leumann, C. J. *J. Am. Chem. Soc.* **2002**, *124*, 5993.
24. Obika, S.; Nanbu, D.; Hari, Y.; Morio, K.-I.; In, Y.; Ishida, T.; Imanishi, T. *Tetrahedron Lett.* **1997**, *38*, 8735.
25. Singh, S. K.; Nielsen, P.; Koshkin, A. A.; Wengel, J. *Chem. Commun.* **1998**, 455.
26. De Mesmaeker, A.; Lesueur, C.; Bévière, M.-O.; Waldner, A.; Fritsch, V.; Wolf, R. M. *Angew. Chem. Int. Ed.* **1996**, *35*, 2790.
27. Nielsen, P. E.; Haaima, G. *Chem. Soc. Rev.* **1997**, 73.
28. Uhlmann, E.; Peyman, A.; Breipohl, G.; Will, D. W. *Angew. Chem. Int. Ed.* **1998**, *37*, 2796.
29. Seio, K.; Wada, T.; Sakamoto, K.; Yokoyama, S.; Sekine, M. *J. Org. Chem.* **1998**, *63*, 1429.
30. Sheit, K. H. *Chem. Ber.* **1966**, *99*, 4.
31. Mungall, W. S.; Greene, G. L.; Heanner, G. A.; Letsinger, R. L. *J. Org. Chem.* **1975**, *40*, 1659.
32. Sekine, M.; Matsuzaki, J.; Hata, T. *Tetrahedron* **1985**, *41*, 5279.
33. Sekine, M.; Kurrasawa, O.; Shohda, K.-I.; Seio, K.; Wada, T. *J. Org. Chem.* **2000**, *65*, 6515.
34. Seio, K.; Wada, T.; Sekine, M. *Helvetica Chimica Acta* **2000**, *83*, 162.
35. Seio, K.; Wada, T.; Sakamoto, K.; Yokoyama, S.; Sekine, M. *J. Org. Chem.* **1996**, *64*, 1500.
36. Ikeda, K.; Tanaka, S.; Mizuno, Y. *Chem. Pharm. Bull.* **1975**, *23*, 2958.
37. Sekine, M.; Kurrasawa, O.; Shohda, K.-I.; Seio, K.; Wada, T. *J. Org. Chem.* **2000**, *65*, 3571.
38. Sørensen, A. M.; Nielsen, P. *Org. Lett.* **2000**, *2*, 4217.
39. Sørensen, A. M.; Nielsen, K. E.; Vogg, B.; Jacobsen, J. P.; Nielsen, P. *Tetrahedron* **2001**, *57*, 10191.
40. Børsting, P.; Nielsen, P. *Chem. Commun.* **2002**, 2140.

41. Børsting, P.; Nielsen, K. E.; Nielsen, P. *Org. Biomol. Chem.* **2005**, *3*, 2183.
42. Børsting, P.; Christensen, M. S.; Steffansen, S. I.; Nielsen, P. *Tetrahedron* **2006**, *62*, 1139.
43. Børsting, P.; Sørensen, A. M.; Nielsen, P. *Synthesis* **2002**, 797.
44. Fürstner, A. *Angew. Chem. Int. Ed.* **2000**, *39*, 3012.
45. Jones, G. H.; Taniguchi, M.; Tegg, D.; Moffat, J. G. *J. Org. Chem.* **1979**, *44*, 1309.
46. Dess, D. B.; Martin, J. C. *J. Am. Chem. Soc.* **1991**, *113*, 7277.
47. Bhat, B.; Leonard, N. J.; Robinson, H.; Wang, A. H.-J. *J. Am. Chem. Soc.* **1996**, *118*, 10744.
48. Caruthers, M. H. *Acc. Chem. Res.* **1991**, *24*, 278.
49. Sholl, M.; Ding, S.; Lee, C. W.; Grubbs, R. H. *Org. Lett.* **1999**, *1*, 953.
50. Morgan, J. P.; Grubbs, R. H. *Org. Lett.* **2000**, *2*, 3153.
51. Ruth, J. L.; Bergstrom, D. E. *J. Org. Chem.* **1978**, *43*, 2870.
52. Cicero, D. O.; Neuner, P. J. S.; Franzece, O.; D'Onofrio, C.; Iribarren, A. M. *Bioorg. Med. Chem. Lett.* **1994**, *4*, 861.
53. Louie, J.; Bielawski, C. W.; Grubbs, R. H. *J. Am. Chem. Soc.* **2001**, *123*, 11312.
54. Kirchhoff, C.; Nielsen, P. *Tetrahedron Lett.* **2003**, *44*, 6475.
55. Sharma, P. K.; Mikkelsen, B. H.; Christensen, M. S.; Nielsen, K. E.; Kirchhoff, C.; Pedersen, S. L.; Sorensen, A. M.; Ostergaard, K.; Petersen, M.; Nielsen, P. *Org. Biomol. Chem.* **2006**, *4*, 2433.
56. Vargeese, C.; Carter, J.; Yegge, J.; Krivjansky, S.; Settle, A.; Kropp, E.; Peterson, K.; Pieken, W. *Nucleic Acids Res.* **1998**, *26*, 1046.
57. Banuls, V.; Escudier, J.-M. *Tetrahedron* **1999**, *55*, 5831.
58. Thrane, H.; Fensholdt, J.; Regner, M.; Wengel, J. *Tetrahedron* **1995**, *37*, 10389.
59. Gorenstein, D. G. *Chem. Rev.* **1987**, *87*, 1047.
60. Le Clezio, I.; Escudier J.-M.; Vigroux, A. *Org. Lett.* **2003**, *5*, 161.
61. Le Roux, C.; Gaspard Iloughmane, H.; Dubac, J.; Jaud, J.; Vignaux, P. *J. Org. Chem.* **1993**, *58*, 1835.
62. Escudier, J.-M.; Tworkowski, I.; Bouziani, I.; Gorrichon, L. *Tetrahedron Lett.* **1996**, *50*, 4689.
63. Dupouy, C.; Le Clezio, I.; Lavedan, P.; Gornitzka, H.; Escudier, J.-M.; Vigroux, A. *Eur. J. Org. Chem.* **2006**, 5515.
64. Banuls, V.; Escudier, J.-M.; Zedde, C.; Claparols, C.; Donnadiou, B.; Plaisancié, H. *Eur. J. Org. Chem.* **2001**, 4693.
65. Kabalka, G. W.; Varma, M.; Varma, R. S.; Srivastava, P. C.; Knapp, F. F. *J. Org. Chem.* **1986**, *51*, 2386.
66. Dupouy, C.; Lavedan, P.; Escudier, J.-M. *Eur. J. Org. Chem.* **2007**, 5256.
67. Le Clezio, I.; Gornitzka, H.; Escudier, J.-M.; Vigroux, A. *J. Org. Chem.* **2005**, *70*, 1620.
68. Sonveaux, E. *Bioorg. Chem.* **1986**, *14*, 274.
69. Reese, C. B.; Titmas, R. C.; Yan, L. *Tetrahedron Lett.* **1978**, 2727.
70. Jones, S. S.; Rayner, B.; Reese, C. B.; Ubasawa, A.; Ubasawa, M. *Tetrahedron* **1980**, *36*, 3075.
71. Dupouy, C.; Lavedan, P.; Escudier, J.-M. *Tetrahedron* **2007**, *63*, 11235.
72. Mukaiyama, T. *Angew. Chem. Int. Ed.* **1977**, *16*, 817.
73. Hakimelahi, G. H.; Proba, Z. A.; Ogilvie, K. K. *Tetrahedron Lett.* **1981**, *22*, 5243.
74. Torres, R. A.; Bruice, T. C. *J. Am. Chem. Soc.* **2000**, *122*, 781.
75. Dupouy, C.; Lavedan, P.; Escudier, J.-M. *Eur. J. Org. Chem.* **2008**, 1285.
76. Tseng, C. K. H.; Marquez, V. E.; Milne, G. W. A.; Wysocki, R. J.; Mitsuya, H.; Shirasaki, T.; Driscoll, J. S. *J. Med. Chem.* **1991**, *34*, 343.
77. Vorbrüggen, H.; Krolikiewicz, K.; Bennua, B. *Chem. Ber.* **1981**, 1234.
78. Gorenstein, D. G.; Rowell, R.; Findlay, J. *J. Am. Chem. Soc.* **1980**, *102*, 5077.
79. Camerman, N.; Fawcett, J. K.; Camerman, A. *J. Mol. Biol.* **1976**, *107*, 601.
80. Dupouy, C.; Iché-Tarrat, N.; Durrieu, M. P.; Rodriguez, F.; Escudier, J.-M.; Vigroux, A. *Angew. Chem. Int. Ed.* **2006**, *45*, 3623.
81. Dupouy, C.; Iché-Tarrat, N.; Durrieu, M. P.; Vigroux, A.; Escudier, J.-M. *Org. Biomol. Chem.* **2008**, *6*, 2849.
82. Ikehara, M. *Heterocycles* **1984**, *21*, 75.
83. Polyanichko, A.; Wieser, H. *Biopolymers* **2005**, *78*, 329.

84. Vallone, P. M.; Paner, T. M.; Hilario, J.; Lane, M. J.; Faldasz, B. D.; Benight, A. S. *Biopolymers* **1999**, *50*, 425.
85. Le Clezio, I.; Dupouy, C.; Lavedan, P.; Escudier, J.-M. *Eur. J. Org. Chem.* **2007**, 3894.

CHEMISTRY OF BIOLOGICALLY ACTIVE β -CARBOLINES

Marta Rosillo, Alvaro González-Gómez, Gema Domínguez and Javier Pérez-Castells*

Departamento de Química, Facultad de Farmacia, Universidad San Pablo-CEU. Urb. Montepríncipe, Boadilla del Monte E-28668-Madrid, Spain (e-mail: jpercas@ceu.es)

Abstract. *Pyrido[3,4-*b*]indoles, commonly known as β -carbolines, are present in a deeply investigated family of indole alkaloids that possess a wide diversity of important biological activities. Herein we review briefly the main structural types found in nature and their biological actions, with a brief summary of synthetic biologically active β -carbolines. Then, we cover the most recent aspects of the chemistry of β -carbolines with focus on the main synthetic approaches devoted to the construction of the heterocyclic system, further functionalization of β -carbolines and transformations into other interesting compounds. Literature regarding total syntheses of natural β -carboline alkaloids is summarized in the final part of the paper.*

Contents

1. Introduction
 - 1.1. Naturally occurring β -carbolines
 - 1.2. Biological activity of β -carbolines
 2. Synthesis of β -carbolines
 - 2.1. The Pictet-Spengler reaction for the construction of the pyridine ring
 - 2.1.1. Catalytic PS reaction
 - 2.1.2. Solid-phase supported PS
 - 2.1.3. Pictet-Spengler combined with other processes
 - 2.2. The Bischler-Napieralski reaction
 - 2.3. Organometallic based methods
 - 2.4. Construction of the pyrrole ring
 - 2.5. Cycloaddition methodologies
 - 2.6. Other strategies
 3. Transformations of β -carbolines
 - 3.1. Oxidations
 - 3.2. Reductions
 - 3.3. Stereoselective alkylations
 - 3.4. Metathesis
 - 3.5. Reactions with activated alkynes
 - 3.6. β -Carbolines as chiral ligands
 4. Total syntheses of natural alkaloids containing the β -carboline system
 5. Conclusions
- Acknowledgments
- References

1. Introduction

There is great interest in the chemistry of β -carboline-containing compounds. This interest comprises the isolation and structural elucidation of new natural products, the evaluation of their biological activity, and the synthesis of derivatives as possible drug candidates. These efforts demand efficient synthetic methodologies, both for the construction of the heterocyclic system and for its functionalization. This chapter will focus on these latter aspects of the chemistry of β -carbolines, although we will include a brief Section with some outstanding examples of natural β -carboline containing alkaloids and with a summary of the main biological activities found for these compounds. Some synthetic β -carbolines specifically designed as potential drug candidates will be shown. Then, Sections 2 and 3 will cover the most recent advances in the synthesis and functionalization of β -carbolines, excluding those previously reviewed by other authors. Finally, it is not the aim of this chapter to include all reports regarding total synthesis of natural compounds containing the β -carboline system, but we will summarize the literature appeared in recent years concerning these syntheses in Section 4.

1.1. Naturally occurring β -carbolines

The β -carboline core is found abundantly in naturally occurring compounds and is part of numerous alkaloids, which often exhibit high biological activity. One can divide these natural compounds into those of low molecular weight and those more complex systems also present in a vast amount of alkaloid-related unnatural compounds. In addition to their importance as natural products with biological activity, some β -carbolines have gained importance as synthetic chiral ligands for certain catalytic processes. The importance of these compounds is the cause of the great efforts devoted to their synthesis, especially in a stereoselective manner.¹

Simple low molecular weight β -carbolines are so often found in nature due probably to their simple biogenesis from tryptamine/tryptophan and carbonyl compounds. Thus, the harmane family, the most simple from the structural point of view, is found in many plant families sometimes bearing substituents. Eudistomines, from marine origin, are included in this group, as well as manzamines, a group of complex molecules in which the β -carboline appears as a substituent of a polycyclic motif (Figure 1). Initially known for their potent psychoactive and hallucinogenic properties, harmane, harmine and harmaline β -carboline alkaloids isolated from various medicinal plants have been shown to exert a wide range of pharmacological properties including antimicrobial and anti-HIV activities.²

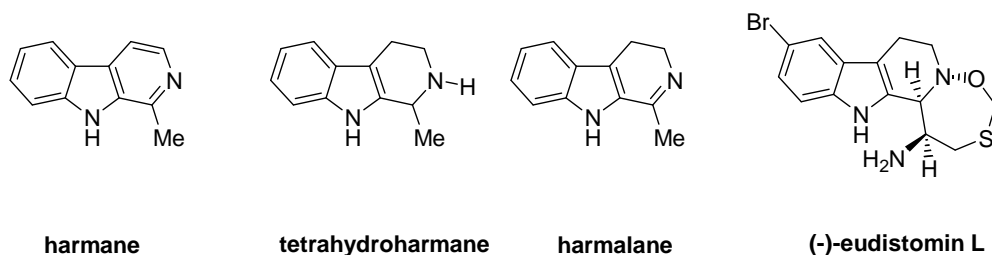
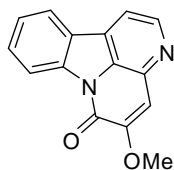

Figure 1

Canthines, with an additional fused cycle, are also found widespread in the Rutaceae and Simaroubaceae families (Figure 2). Some of them possess antifungal activity.³



5-methoxycanthin-6-one

Figure 2

More complex structures including the β -carboline motif generally arise from mixed biogenetic origin. These generally include a C5 subunit derived from mevalonate. Eburnamine alkaloids are a vast family of compounds with at least five fused cycles that can be divided into several sub-groups, such as eburnamine itself, occurring in several plant groups, vincamine, from the *Vinca* species and those from *Schizozygia* species (Figure 3). Quite a few of these alkaloids exert varied pharmacological activities on cell multiplication, cardiovascular system and brain functions. For example, (+)-vincamine is being used in the treatment of cerebral, vascular and metabolic diseases.⁴

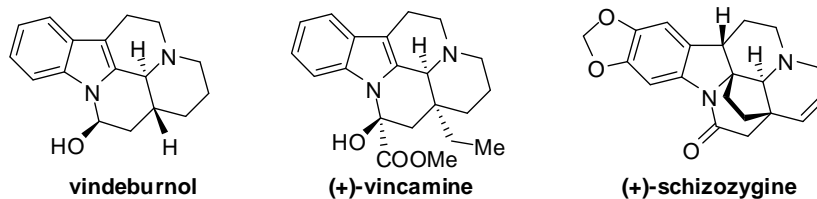

Figure 3

An important group of biologically related complex alkaloids are those included in the heteroyohimban family. These include corynantheidine, ajmalicine, pleiocarpamine, vobasine and sarpagine. (–)-Ajmalicine is prescribed widely in the treatment of cardiovascular diseases. The sarpagine alkaloid (+)-vellosimine is used for the treatment of neuralgia, migraine and hypertension, and (+)-ajmaline is an antiarrhythmic agent (Figure 4).⁵

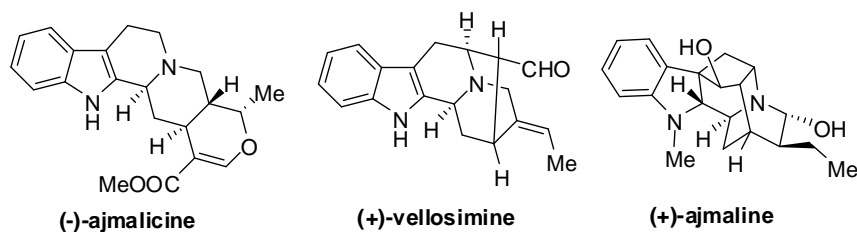

Figure 4

The group of yohimban alkaloids is possibly the most popular among the organic synthesis community as many efforts devoted to their synthesis have been made. This group comprises yohimbine, which has been used to treat erectile dysfunction and reserpine, an antipsychotic and antihypertensive drug. These are two natural compounds found in nature jointly with several of their isomers and derivatives (Figure 5).

In addition to the examples mentioned above, a great number of oligomeric alkaloids bear the β -carboline skeleton (Figure 6). Most of these arise biogenetically from the dimerization *via* condensation,

Mannich, Michael reactions or coupling by phenol oxidations of two units of the monomeric classes of alkaloids. Figure 6 shows two examples of these classes of compounds.

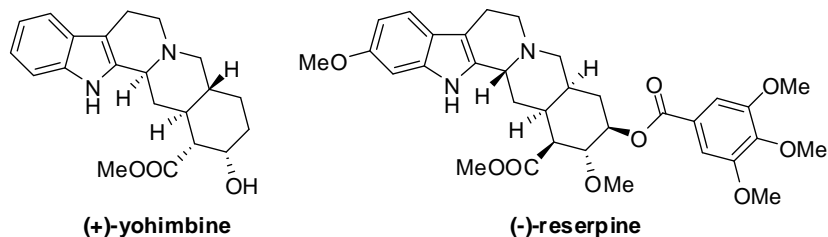

Figure 5

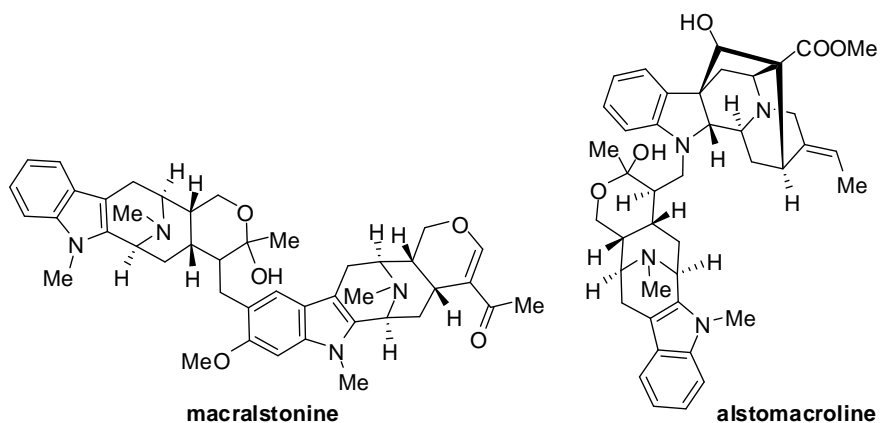

Figure 6

1.2. Biological activity of β -carboline

Alkaloids with a β -carboline nucleus possess widespread and potent biological activities and this has prompted many groups to design new derivatives as potential drugs for the treatment of various diseases. The number of biological activities described for β -carboline containing compounds is huge and we will only summarize those more frequently found, showing a bunch of selected examples.

Some natural β -carboline alkaloids display antineoplastic activity. This has prompted many groups to design and synthesize new compounds that exhibit this activity. For example, lavendamycin, a naturally occurring 7-aminoquinoline-5,8-dione antitumor antibiotic, has been the focus of several synthetic studies to elucidate the structural features that are required for its cytotoxic activity and to develop improved analogues with potent antitumor properties and lower animal toxicity (Figure 7).^{6,7}

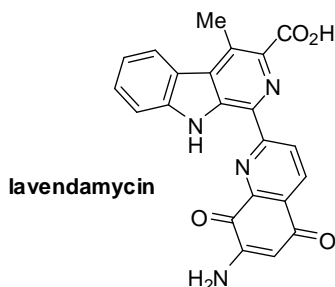

Figure 7

Based on the pharmacore reported for benzodiazepine receptor agonist ligands, ethyl 4-(methoxymethyl)-6-propoxy-9H- β -carboline-3-carboxylate, 6-PBC, (IC_{50} =8.1 nM) was designed, synthesized and evaluated (Figure 8). When evaluated *in vivo* this compound exhibited anticonvulsant/anxiolytic activity but was devoid of the muscle relaxant/ataxic effects of “classical” 1,4-benzodiazepines (*i.e.* diazepam).⁸

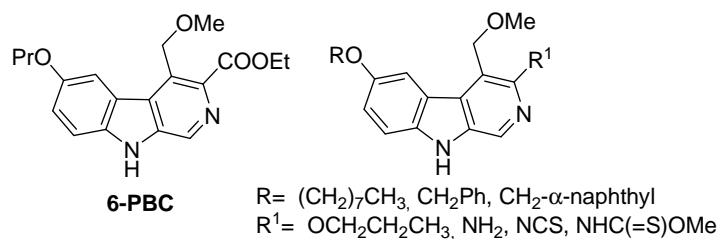

Figure 8

Regarding antiviral activity, some β -carboline derivatives bearing guanidinium groups or amino group-terminated side chains were synthesized targeting the *trans*-activation response region (TAR) element. Compounds shown in Figure 9, with a terminal guanidinium group, showed inhibitory activities on protein Tat-TAR interaction as well as to HIV-1 in MT4 cells (Figure 9).⁹

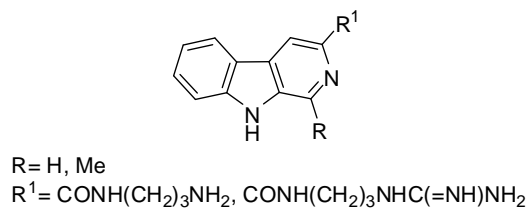

Figure 9

Many β -carbolines show antimalarial and antiparasite activity. In a very recent example, a series of hybrid molecules 2-[3-(7-chloro-quinolin-4-ylamino)-alkyl]-1-(substituted phenyl)-2,3,4,9-tetrahydro-1H- β -carbolines were synthesized and screened for their *in vitro* antimalarial activity against chloroquine-sensitive strains of *Plasmodium falciparum*. Compounds shown in Figure 10 have exhibited minimum inhibitory concentration values in the range of 0.05–0.11 μ M and are several folds more active *in vitro* than chloroquine.^{10,11}

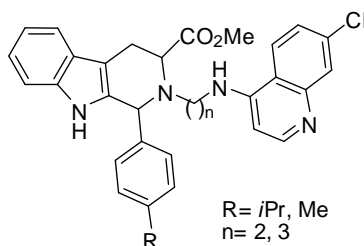

Figure 10

A series of hexahydropyrazino[10,20:1,6]pyrido[3,4-*b*]indole-1,4-diones (Figure 11) were disclosed recently as potential anti-thrombosis agents. The anti-thrombosis activity from both *in vitro* and *in vivo* studies revealed that these compounds may be a new class of anti-thrombosis agents.^{12,13}

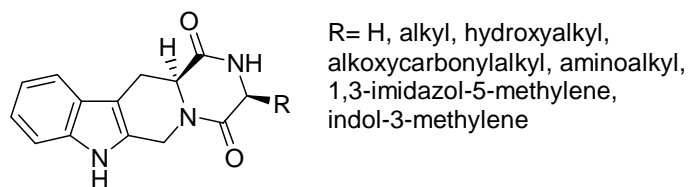

Figure 11

Many other biological activities have been described for β -carboline containing compounds, both from natural and synthetic origin. β -Carbolines were designed recently showing important inhibition ability of the TNF- α production.¹⁴ Related with this work was the description of a series of potent, carboline-based, protein kinase MK2 inhibitors.¹⁵ 6-Hydroxy- and 6-methoxy- β -carbolines were described as acetyl- and butyrylcholinesterase inhibitors.¹⁶ Very recently, analogues of eudistomin D, a β -carboline alkaloid from marine origin were synthesized and showed affinity and selectivity for adenosine receptors A₃.¹⁷ A new class of mGluR₁ (metabotropic glutamate receptor 1) antagonists was designed bearing a tricyclic β -carboline template.¹⁸ Moreover, certain β -carbolines were found to stimulate insulin secretion in a glucose-dependent manner, probably by acting on I₃-binding site.¹⁹ A series of ring-substituted 3,4-dihydro- and 1,2,3,4-tetrahydro- β -carbolines was examined at 5-HT_{2A} and 5-HT_{2C} serotonin receptors. Some bromo substituted β -carbolines displayed enhanced affinity.²⁰ Bromo substituted tetrahydro- β -carbolines were also described as neurotoxic agents.^{21,22}

2. Synthesis of β -carbolines

In principle, two main strategies are possible to construct the β -carboline system, *i.e.* the formation of the pyridine ring and the synthesis of the pyrrole ring. The latter option has been used fewer times, possibly due to the availability of suitable functionalized indoles which are activated substrates that give efficiently Friedel-Crafts (FC) reactions. Indeed, the intramolecular alkylation of aromatics has become a matter of increasing importance as it allows the synthesis of challenging polycyclic fused compounds from inexpensive materials. This Section will revise the most recent contributions to the synthesis of the β -carboline system. The first three Sections are devoted to the formation of the pyridine ring by means of Friedel-Crafts-type reactions followed by methodologies based on organometallic mediation or catalysis. Section 2.4 deals with the synthesis of the pyrrole ring, Section 2.5 some cycloaddition methodologies and Section 2.6 gathers the rest of strategies appeared in the literature.²³

Over the past years, a great number of highly chemo- and regioselective intramolecular Friedel-Crafts-type alkylations of aromatic compounds have been described in the literature that allow remarkable synthetic shortcuts. Both transition metals and Lewis acids have been described to promote ring-closing reactions even in the presence of polyfunctionalized cyclization precursors. The emerging field of catalytic enantioselective FC alkylations has recently concerned also intramolecular transformations both in the presence of chiral organic and organometallic promoters.²⁴

2.1. The Pictet-Spengler reaction for the construction of the pyridine ring

The Pictet-Spengler (PS) reaction is the most commonly employed synthetic route toward β -carbolines. This process, known since 1911,²⁵ was initially applied to the synthesis of 1,2,3,4-tetrahydro-isoquinolines **1** but was soon used with tryptamine derivatives for the preparation of tetrahydro- β -carbolines

2 (Scheme 1). It consists of a condensation of an aliphatic amine with an aldehyde or an activated ketone and cyclization of the imine formed. The latter step is normally activated by Brønsted or Lewis acids. The resulting product is a tetrahydro- β -carboline. Many efforts have been made to improve the scope and the efficiency of this reaction in the past years. Thus, reactions in non-acidic or aprotic media or activation of the intermediate imine by formation of *N*-acyl or *N*-sulfonyl imines have widened the range of substrates that cyclize efficiently. Other improvements in the reaction conditions include biomimetic approaches using enzymes,²⁶ acceleration using microwaves or zeolites²⁷ and reactions under photochemical conditions.²⁸

In addition to aldehydes, ketals, acetals, enol ethers, thioorthoesters, several α -chloro chalcogenocarbonyls, enamines, azlactones or alkynes can act as electrophilic partners in PS reactions. On the other hand, only tryptophan or tryptamine derived amines have been used.

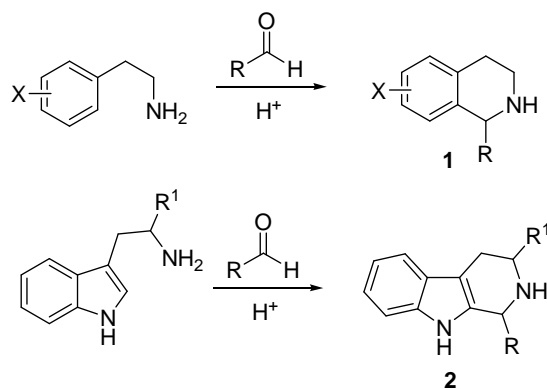

Scheme 1

Numerous alkaloid syntheses demand the availability of efficient methods to introduce asymmetry in the PS reaction. The C1 centre, generated in the cyclization process, is stereogenic and chirality transfer can be achieved from enantiomerically pure substrates or if chiral auxiliaries are appropriately situated. Tryptophan derived esters have been used many times, as they are easily available. Chiral auxiliaries have mainly been attached to the nitrogen of the ethylamino chain, either prior to the reaction or by acylating the intermediate imine with a chiral acyl chloride. Thus, the condensation is in this case performed with secondary amines, leading to iminium ions as reactive intermediates. The PS reaction of iminium ions has been recently reviewed, especially with emphasis on the stereochemical outcome of this mode of cyclization (Scheme 2).²⁹

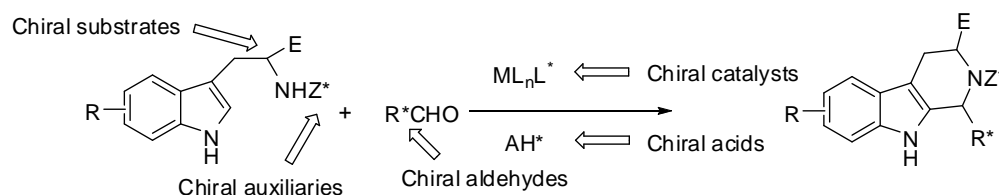

Scheme 2

Chiral aldehydes lead in many cases to high enantiomeric excess. Oppolzer-Sultam, chiral α -amino-aldehydes and sugar-derived aldehydes are some of the examples found in the literature. Chiral acids are the other possible asymmetry inducers, but they have been used fewer times.³⁰ All these advances and the main

synthetic applications of this reaction to the synthesis of potentially active β -carbolines or naturally occurring alkaloids have been reviewed by Youn in 2006,³¹ so that we will only consider the most recent contributions in this field.³²

The lack of suitable amine substrates for the PS reaction, apart from tryptophan derivatives, have prompted some groups to develop synthesis of substituted tryptamines leading to tetrahydro- β -carboline with new substitution patterns. Thus, chiral hydrogen-bonding *bis*-sulfonamides were used as effective catalysts for the enantioselective FC addition of indoles to nitro-olefins. The optically active products are β -substituted nitrocompounds **3**, obtained in high yields but with modest enantioselectivities (up to 64% *ee*, improvable to >98% *ee* by recrystallization). Reduction of the nitro group to the amine and stereocontrolled PS cyclization gave enantiopure tetrahydro- β -carbolines **4** (Scheme 3).³³

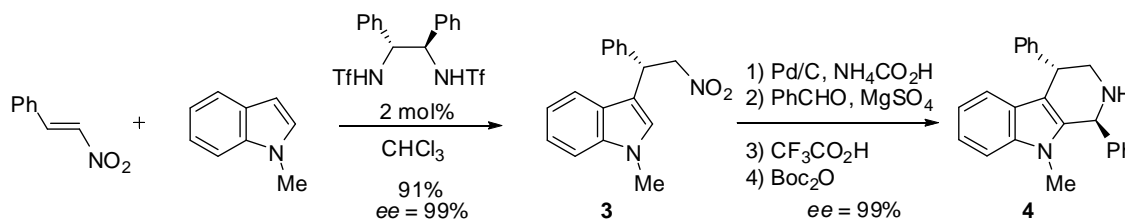

Scheme 3

Kusurkar recently reported a microwave-assisted conjugate addition of indole on nitro-olefins that furnished nitro compounds **5**, which were reduced to tryptamines. These compounds gave 1,4-disubstituted- β -carbolines **6** in a diastereoselective manner. In some of the cases, PS condensation and dehydrogenation gave a mixture of 1,4-disubstituted- β -carbolines and 1,4-disubstituted- γ -carbolines (Scheme 4).³⁴

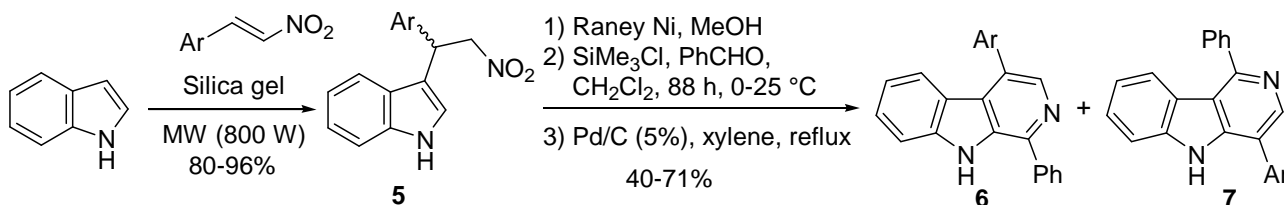

Scheme 4

Newly disclosed reaction conditions have expanded the scope of the reaction. Thus, most PS reactions are carried out with aldehydes or activated ketones such as 1,2-dicarbonyl compounds. Lingam developed an iodine-induced PS reaction with non-activated ketones yielding 1,1-disubstituted tetrahydro- β -carbolines **8** as the only products (Scheme 5).³⁵

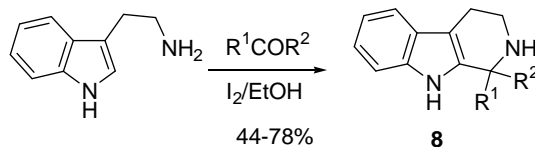

Scheme 5

Similarly, condensation of ninhydrin with tryptamide or tryptamine, followed by Lewis acid-induced rearrangement, provided yohimbanones **9** that were readily converted to β -carbolines **10** via oxidative ring cleavage (Scheme 6).³⁶

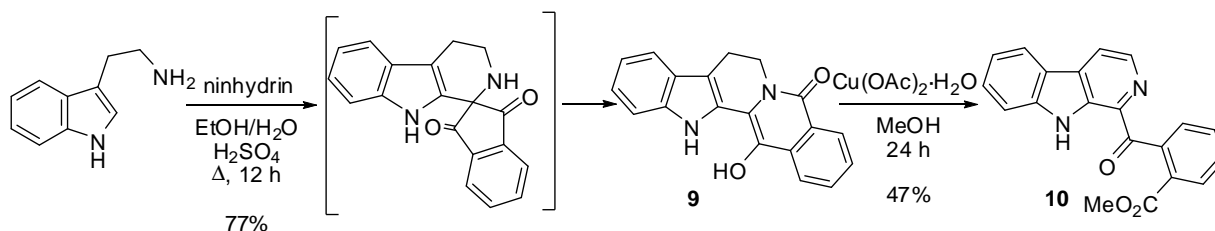

Scheme 6

Modified PS reaction conditions were tuned up for the synthesis of 1-substituted β -carbolines without formation of the tetrahydro derivatives. In one step, L-tryptophan reacted with aldehydes (1,2-dicarbonyl compounds) giving β -carbolines. The procedure was applied to the synthesis of a natural alkaloid from *Illigera luzonensis*.³⁷

As indicated above, in addition to imines and iminium ions, many functional groups act as electrophilic partners in the PS reaction. Many early works dealt with this aspect and have been reviewed before.³¹ The most recent contributions of PS reactions with new electrophilic groups follow. Thus, the use of thioorthoesters as electrophilic partners in the PS has improved the scope of the PS cyclization. Silveira reported the synthesis of 1-arylthio- and 1-alkylthio-tetrahydro- β -carboline derivatives **11** (Scheme 7). The reaction of *N*-tosyltryptamines with thioorthoesters as electrophiles under Lewis acid conditions gave access to this new family of compounds, some of them otherwise difficult to obtain.³⁸

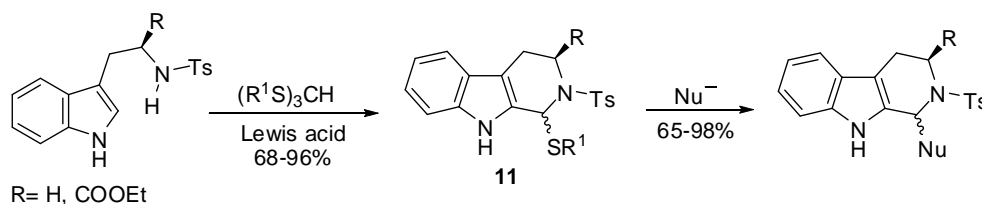

Scheme 7

A new PS-like reaction based upon the ring opening of indole substituted methyleneaziridines has appeared recently. This approach is a new entry into 1,1-disubstituted tetrahydro- β -carbolines, which are difficult to obtain by classical PS methods. The treatment of **12** with an equimolar quantity of $\text{BF}_3 \cdot \text{OEt}_2$, then an alcohol as nucleophile and the subsequent warming of the reaction mixture to room temperature overnight afforded **13** in moderate to good yields (Scheme 8).³⁹

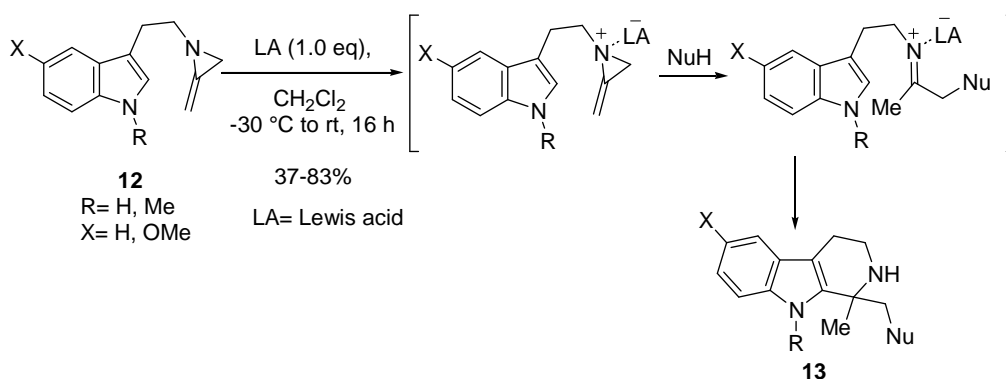

Scheme 8

Unsaturated 5(4*H*)-oxazolones have been used in modified intermolecular and intramolecular PS reactions as arylacetaldehyde equivalents. These compounds are hydrolyzed to arylpyruvic acid, which is the reactive species. In a recent example, compound **14** was shown to undergo an intramolecular reaction in the presence of CF₃CO₂H, to afford β-carboline **15** and a cyclopenta[*b*]indolone **16** by nucleophilic addition at C2 and C5, respectively (Scheme 9). The distribution of these two products was found to be dependent on the reaction temperature, with lower temperatures favouring the formation of the β-carboline **15**.⁴⁰

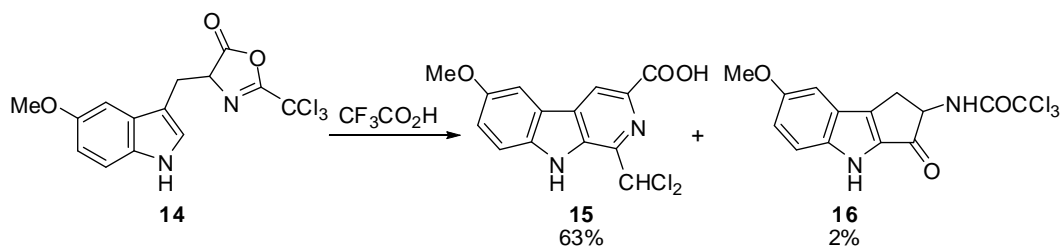

Scheme 9

In the field of asymmetric PS, a recent contribution studied the reaction of tryptophan with α-aminoaldehydes derived from L- and D-amino acids in terms of double stereodifferentiation. When the reaction is performed with L-Trp-OMe, the results observed for D-amino aldehydes represent ‘*matched*’ situation (one diastereoisomer was formed exclusively, Scheme 10), whereas with L-amino aldehydes ‘*mismatched*’ (two diastereoisomers were formed with the dominance of the *trans* isomer). Condensation of D-Trp-OMe and L-aldehydes gives only the *cis*-**17** isomer while the reaction with D-aldehydes provides a mixture of *cis/trans*-**17** isomers with dominance of the *trans*-**17** compound.⁴¹

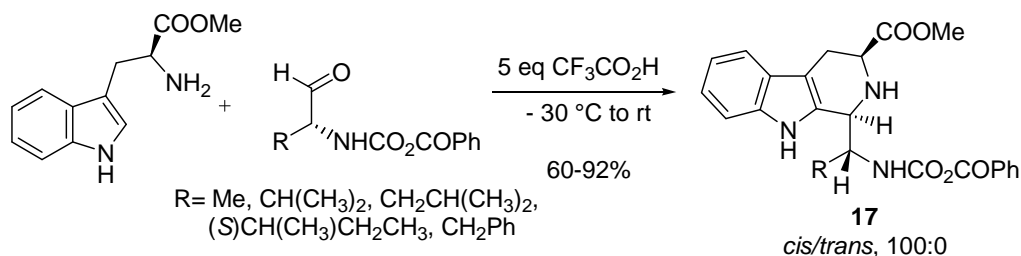

Scheme 10

In a related contribution, acid-catalyzed condensation of tryptophan with different α-aminoaldehyde derivatives gave compounds containing a tetrahydro-β-carboline. This study was extended to the synthesis of novel octahydropyrrolo[3',2':3,4]pyrrolo[2,3-*b*]indole systems.⁴²

2.1.1. Catalytic PS reaction

The growing trend to substitute traditional stoichiometric transformations by more environmentally benign catalytic processes has reached PS chemistry. Catalysis allows improving waste balance, because of high atom efficiency and selectivity as well as tolerance of a broad range of functional groups. Although indoles are reactive substrates for C-H alkylation reactions, most cases of PS cyclization need activation. There is a growing interest in making this activation in a catalytic way. There are two possibilities, as the catalyst may activate the tethered electrophilic partner or the aromatic compound. As in the non-catalyzed

version, the electrophilic centre can be activated by Brønsted or Lewis acids, or by formation of acyl or sulfonyl imines. Alternatively, the insertion of metal species in low oxidation states into a sp^2 -hybridized C-H bond forms highly reactive organometallic species that can be successfully trapped with the electrophilic partner.

Ganesan has reported a parallel screening approach for the discovery of effective Lewis acid catalysts for PS reactions. From this study it appears that both aldehyde- and imine-selective Lewis acids are effective in catalyzing the cyclization. The best catalyst was $Yb(OTf)_3$ with which the loading was significantly low (5%) using microwave irradiation (Scheme 11).⁴³

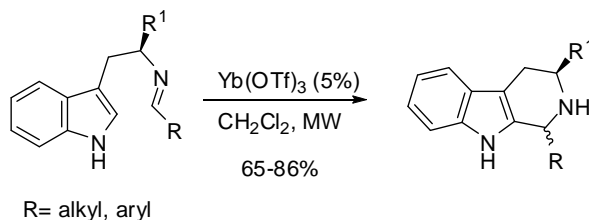

Scheme 11

An impressive example of a catalytic and enantioselective PS condensation was recently disclosed by Jacobsen and Taylor appeared recently. A family of chiral thioureas **18** were able to catalyze the cyclization of both pre-formed and *in situ* obtained indolylimines, **19**. The reaction conditions involved the activation of the imine with acetyl chloride and reaction of the thiourea with the highly reactive *N*-acyliminium intermediate. This methodology gave 1-substituted-tetrahydro- β -carboline **20** with 93% *ee*, with R being aliphatic (Scheme 12).⁴⁴

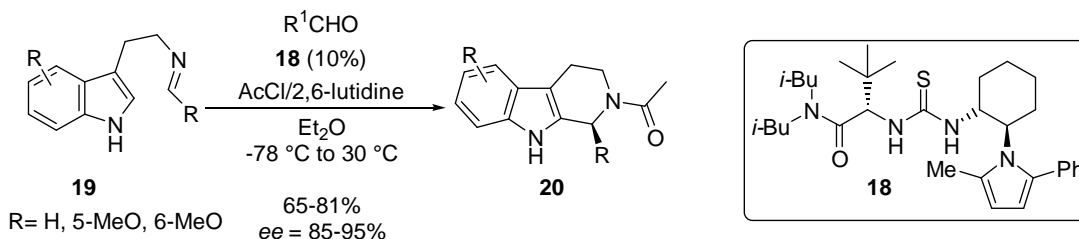

Scheme 12

Soon afterwards, an efficient and highly enantioselective Brønsted acid-catalyzed PS reaction of substituted tryptamines to the corresponding tetrahydro- β -carboline using a chiral phosphoric acid catalyst was disclosed. The process works both with aromatic and aliphatic aldehydes which are treated with chiral Brønsted acid catalyst **21**. As the main limitation, the methodology requires that the substrate bears a geminal diester functionality (Scheme 13).³⁰

Hiemstra circumvented the limitation of the former procedure and reported a catalytic asymmetric PS reaction *via* an *N*-sulfenyliminium ion catalyzed by a *bis*-trifluoromethylphenyl-substituted (*R*)-BINOL phosphoric acid. Both alkyl- and aryl-substituted tetrahydro- β -carboline were obtained in 77–90% yields after cyclization and removal of the tritylsulfonyl group in a one-pot procedure, with *ee* values up to 87%.⁴⁵ More recently they synthesized optically active *N*-benzylprotected tetrahydro- β -carboline in high yields and

with *ee* values up to 87%. The triphenylsilyl-substituted BINOL-phosphoric acid (BINOL-PA) proved to be the catalyst of choice for the reaction with aromatic aldehydes. For aliphatic aldehydes, 3,5-bis-trifluoromethylphenyl-substituted BINOL-phosphoric acid was identified as the best catalyst (Scheme 14). The method is scalable and was applied to the synthesis of the pharmaceutically relevant phosphodiesterase type 5 (PDE₅) inhibitors of the pyrroloquinolone class by means of a Winterfeldt oxidation.⁴⁶

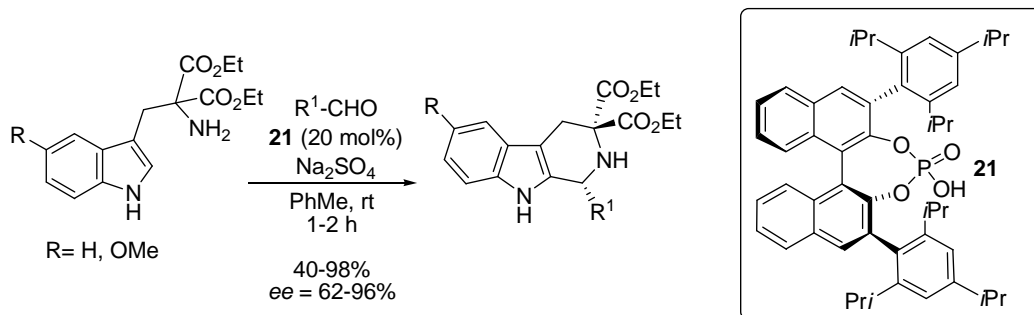

Scheme 13

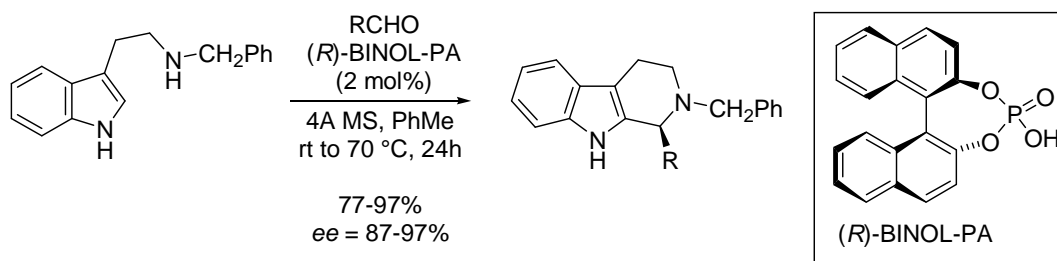

Scheme 14

Hsung's group has made many contributions enhancing the synthetic utility of ynamides. In particular, arene-ynamides are suitable substrates for the synthesis of different polycyclic compounds.⁴⁷ The best acid to catalyze these reactions was *p*-nitrobenzenesulfonic acid which proved to be superior to Lewis acids including transition metal salts such as PtCl₂, PtCl₄, and AgNTf₂. In particular, the cyclization of C-tethered arene-ynamides **22** to give tetrahydro-β-carboline **23** worked smoothly, giving rise to excellent yields within a few minutes. The authors postulate that these PS cyclizations proceed *via* a highly reactive keteniminium ions that undergo intramolecular nucleophilic attack by the aromatic ring (Scheme 15).⁴⁸

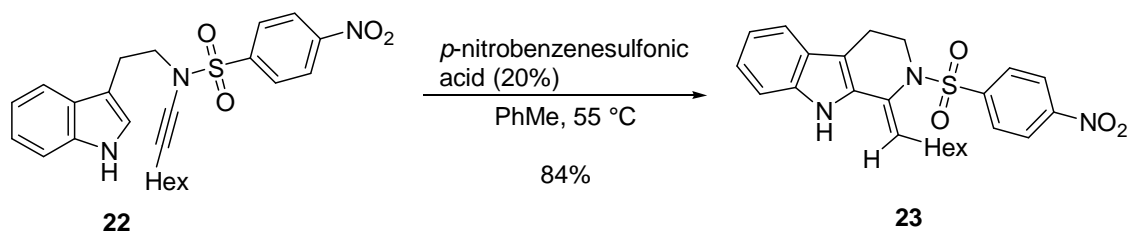

Scheme 15

Youn reported AuCl₃/AgOTf-catalyzed PS reactions that afforded a variety of tetrahydroisoquinolines and β-carbolines/tetrahydro-β-carbolines. In this reaction the role of the gold(III) complex is probably the coordination and activation of the imine (Scheme 16).⁴⁹

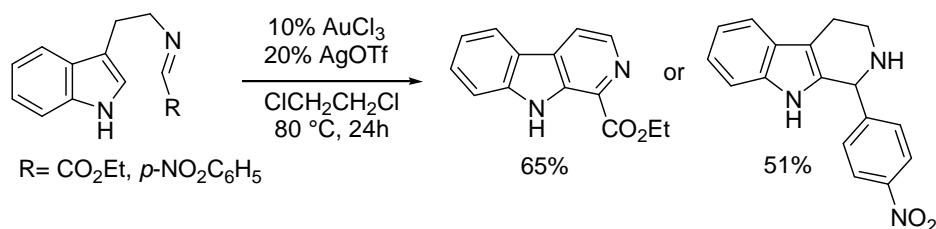

Scheme 16

A mild and efficient protocol for PS reactions in water using $\text{CF}_3\text{CO}_2\text{H}$ as acid catalyst has been described. The procedure was general from the aldehyde side giving good isolated yields. The authors observed a general trend of Trp-OMe and aryl/aliphatic aldehydes to furnish diastereomeric mixtures with a preference for the *cis*-isomer (Scheme 17).⁵⁰

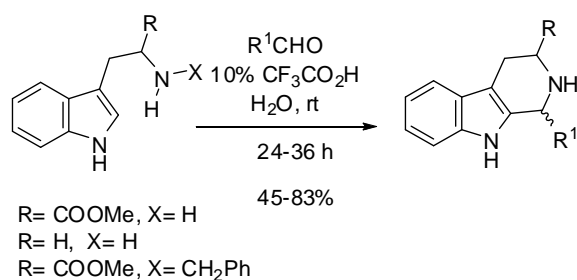

Scheme 17

2.1.2. Solid-phase supported PS

Several solid-phase versions of the PS reaction have been reported, where the solid support is linked to the reactives at different positions. Figure 12 summarizes the approaches that are included in previously published reviews.⁵¹ Below we show the most relevant or recent examples of each approach appeared in the literature.

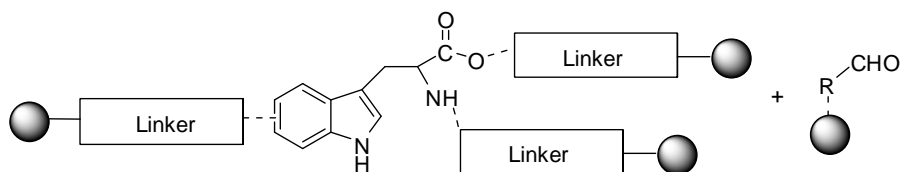
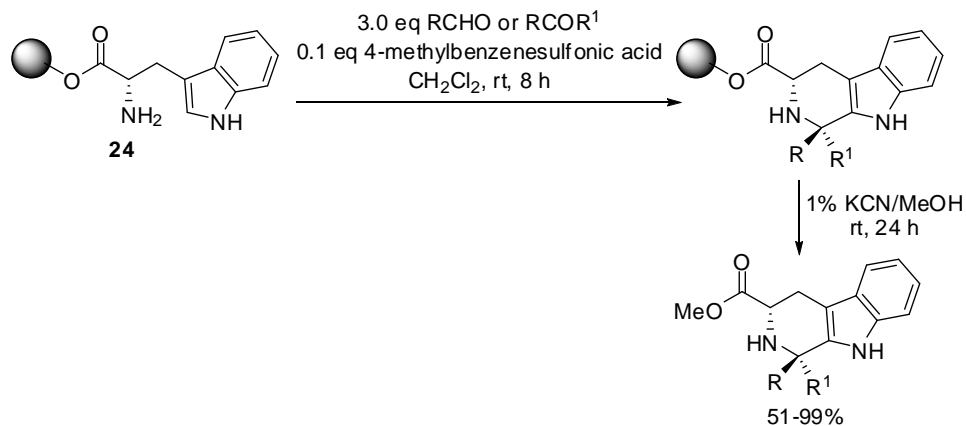

Figure 12

The most typical approach comprises the Brønsted acid-catalyzed intermolecular condensation of an aldehyde with the amino terminal of a solid-supported tryptophan derivative, which is bound to the solid resin through a linker at the carboxylic group. For example, parallel synthesis of β -carbolines on soluble polyethylene glycol (PEG-OH) support can be achieved by condensation of polymer-bound tryptophan residues **24** with various aldehydes and ketones in the presence of 4-methylbenzenesulfonic acid (Scheme 18).⁵² Alternatively, elaborated masked aldehydes were incorporated to a resin bound dipeptide were tryptophan was present. Treatment with acidic conditions liberated the aldehyde giving rise to β -carbolines.⁵³



Scheme 18

Less frequent is the use of indoles linked by the benzene ring or through auxiliaries bound to the amine group. An example of the first approach is the synthesis of a library of biologically relevant 6-hydroxy-tetrahydro- β -carbolines **25** based on the L-5-OH-tryptophan scaffold (Scheme 19). The library was designed such that three points of diversity would be readily introduced.⁵⁴

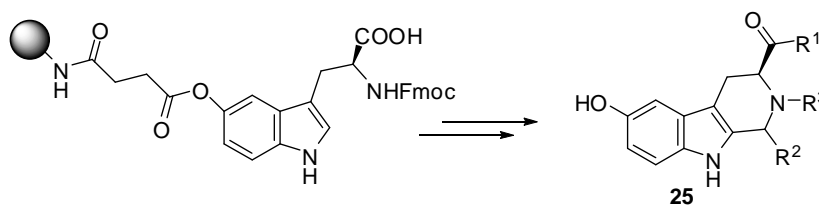

Scheme 19

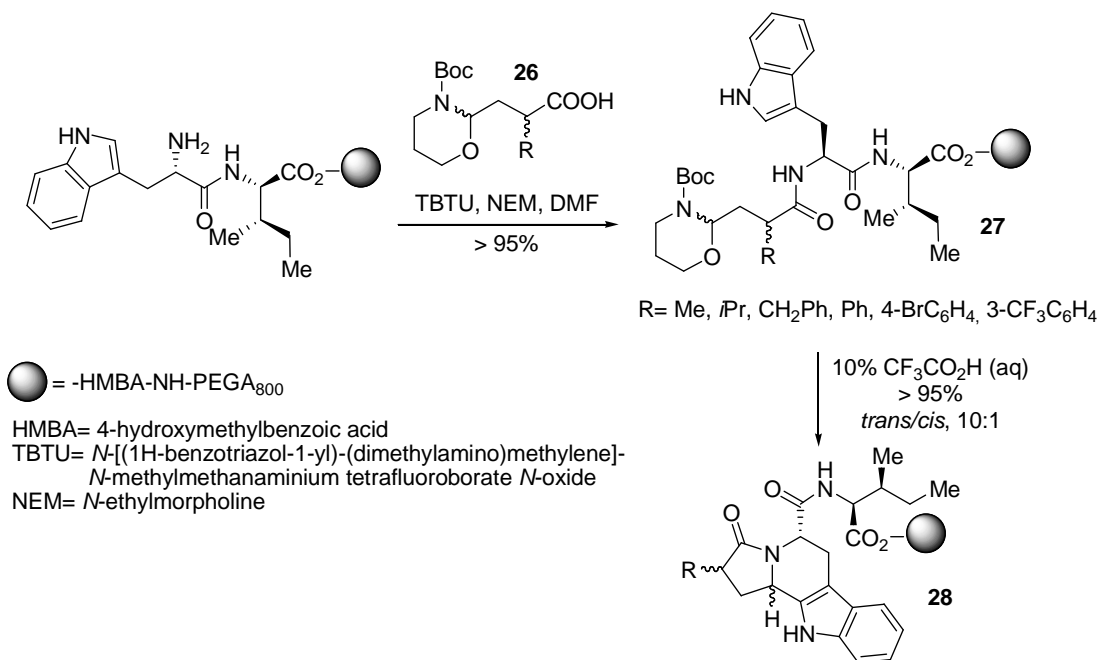

Scheme 20

Alternatively to these general precedents in the field of solid-phase PS reactions, some contributions have focused on the intermolecular condensation of solid-supported aldehydes with tryptophan and

tryptamine derivatives. Examples of this latter methodology include a triple process carried out with masked aldehyde building blocks protected as their *N*-Boc-1,3-oxazinanes **26**. In one synthetic step, by simple treatment of **27** with 10% $\text{CF}_3\text{CO}_2\text{H}$, an intramolecular PS reaction sequence takes place, comprising the steps of aldehyde generation, formation of *N*-acyliminium ion and cyclization giving **28** (Scheme 20). Overall, two new fused rings are appended to the reactive aromatic side chain in excellent yields (>95%).⁵⁵

A solid-phase PS tandem cyclization on *in situ* generated acyl-iminium during acidic cleavage from polymer supports was reported. A pilot library with two diversity elements was synthesized to demonstrate the efficacy of this strategy (Scheme 21).⁵⁶

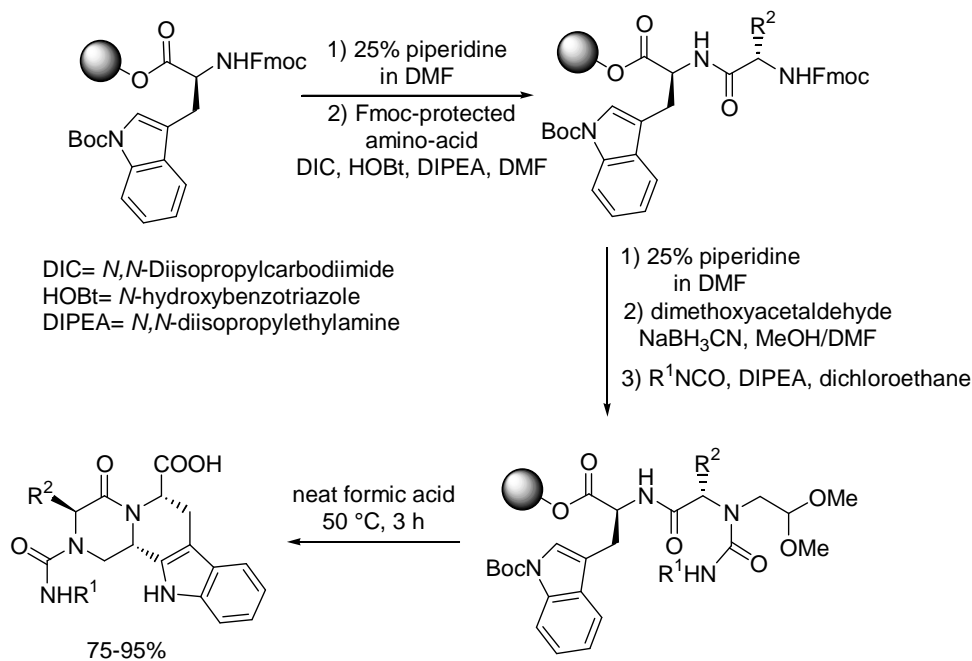

Scheme 21

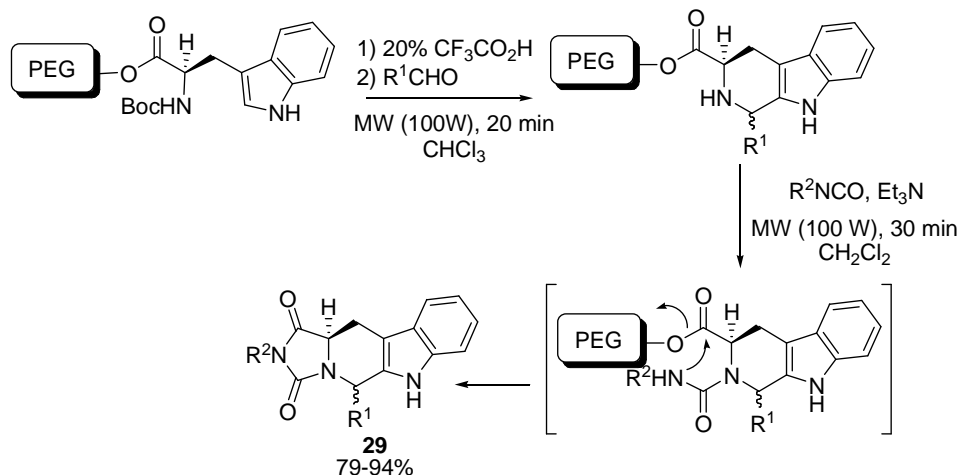

Scheme 22

The most recent contribution in this field is a multistep microwave-assisted reaction for the synthesis of hydantoin-fused tricyclic tetrahydro- β -carboline **29** on a soluble polymer support (Scheme 22). After constructing the β -carboline system from polymer-bound tryptophan and various aldehydes, the terminal

hydantoinyl moiety was formed by the reaction of the products with various isocyanates under microwave irradiation to form an urea intermediate. Simultaneous intramolecular cyclization of the urea followed by cleavage of the polymer support lead to the desired tetracyclic scaffolds in high yield and high purity.⁵⁷

2.1.3. Pictet-Spengler combined with other processes

Multi-component reactions and sequential one-pot processes are gaining a considerable and increasing academic, economic and ecological interest as they imply great synthetic efficiency. Additionally, the modular aspect of one-pot reactions can be readily expanded into combinatorial and solid phase synthesis so that great opportunities for developing novel lead structures of pharmaceuticals are possible. Thus, the concept of integrating the PS reaction with other transformations has been addressed in the β -carboline chemistry, both for the synthesis of the starting indolyethylamine and subsequent PS cyclization and for the combination of this reaction with further transformations of the β -carboline system.

One example of the first possibility has used the Yonemitsu-type trimolecular condensation as the first step, followed by a PS transformation for the preparation of 3,4-heterocycle (furanone-, pyrrolidinone- and pyranone-) annulated tetrahydro- β -carbolines, **30**. The chirality of D-glyceraldehyde or that of Garner's aldehyde ensured a high and predictable diastereocontrol of the additional newly created stereocentres (Scheme 23).⁵⁸

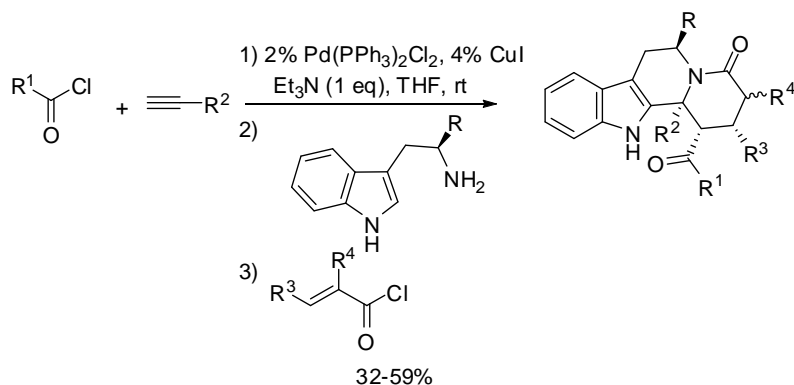
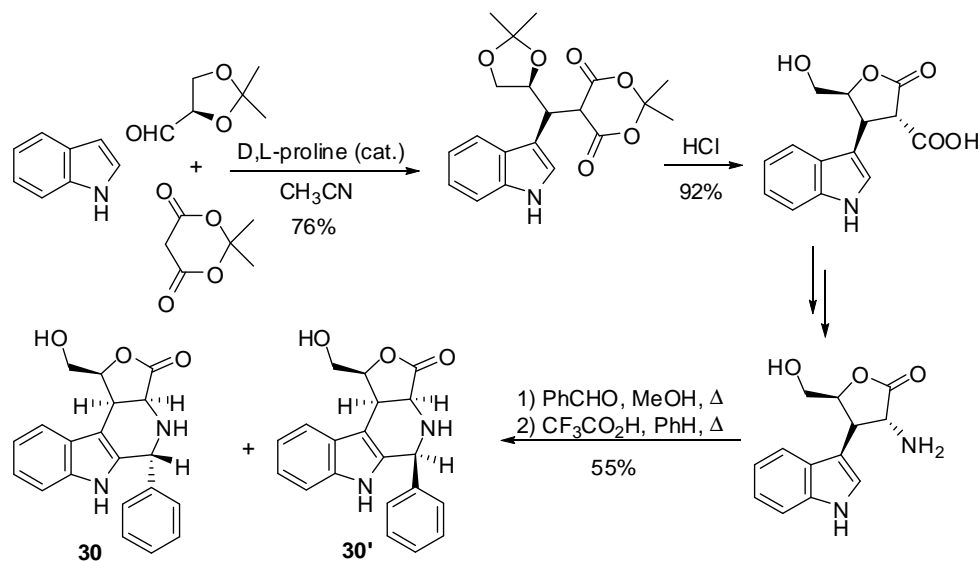

Another spectacular example by Müller and collaborators is a consecutive four-component synthesis consisting of a coupling-amination-aza-annulation-Pictet-Spengler (CAAPS) sequence creating five new σ -bonds and four new stereocentres in a one-pot fashion. Starting materials were diverse acid chlorides and aliphatic or aromatic alkynes as well as TMS-acetylene and a tryptamine derivative (Scheme 24).⁵⁹

Finally, the pentacyclic benzo[*f*]indolo[2,3-*a*]quinolizine intermediate **31** was constructed in an overall yield of 54% by means of a tandem intermolecular formal aza-[3+3] cycloaddition/PS cyclization. The strategy constitutes a new effective general synthetic approach toward the indoloquinolizine family of alkaloids (Scheme 25).⁶⁰ Very recently, these *N*-indolylalkyl substituted 4-piperidinenones have been readily obtained upon reaction of the corresponding 4-piperidones with mercuric acetate and used in PS reactions.⁶¹

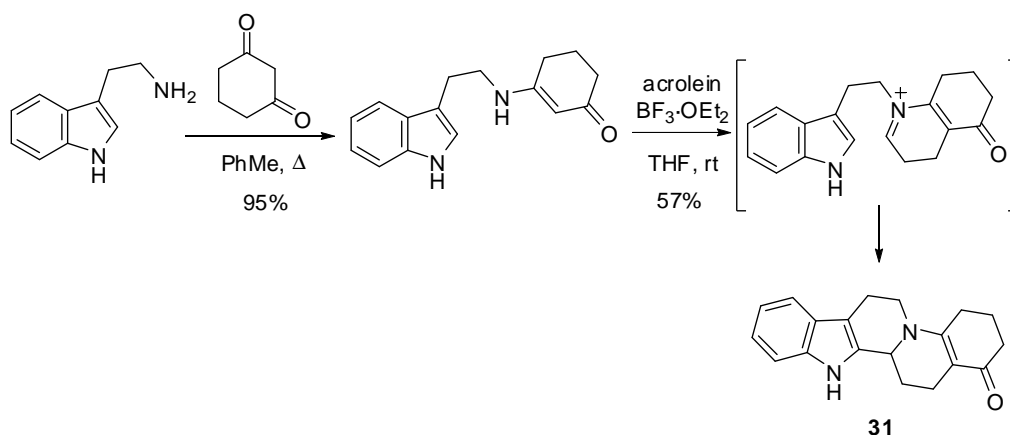

Scheme 25

2.2. The Bischler-Napieralski reaction

The Bischler-Napieralski (BN) reaction⁶² is widely used in the synthesis of β -carboline derivatives. As the PS, it is an ancient reaction discovered in the XIXth century. The starting material is usually an aliphatic amine that is converted into an amide by acylation with an acid chloride. This amide undergoes intramolecular cyclization onto an aromatic ring when it is treated with dehydrating agents forming a dihydropyridine ring. Alternatively to acid chlorides, a recent contribution used polarized ketone *N,S*-acetals in a BS reaction.⁶³ In order to achieve milder reaction conditions, BN reactions have been promoted with $(\text{PhO})_3\text{PCl}_2$ instead of POCl_3 .⁶⁴ Many indole alkaloids have been synthesized with the help of this reaction though it has been less used due to the rather drastic conditions needed with many amides (Scheme 26).

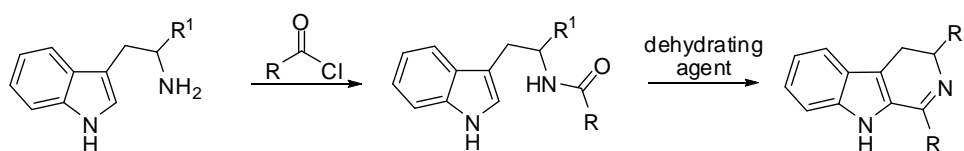

Scheme 26

A recent example of synthetic application of this reaction is the synthesis of the quinazolinocarboline alkaloids rutaecarpine, euxylophoricine A, euxylophoricine C and dehydroevodiamine (Figure 13). The quinazoline ring was efficiently formed from the ring opened β -carboline derivative by a one-pot reductive-cyclization reaction.⁶⁵

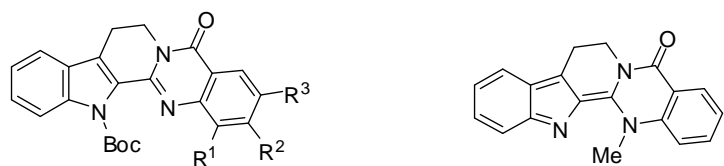

$R^1 = R^2 = R^3 = H$; rutaecarpine
 $R^1 = H$; $R^2 = R^3 = OMe$; euxylophoricine A
 $R^1 = H$; $R^2, R^3 = -O-CH_2-O-$; euxylophoricine C

dehydroevodiamine

Figure 13

Another recent example devoted to the formal synthesis of indolo[2,3-*a*]quinolizine alkaloids used piperidin-2-ones as the electrophilic partner of the BN reaction. An intermolecular aza-double Michael reaction was used to obtain functionalized piperidin-2-ones, **32**, from simple starting materials, which formed β -carboline **33** via BN reaction (Scheme 27).⁶⁶

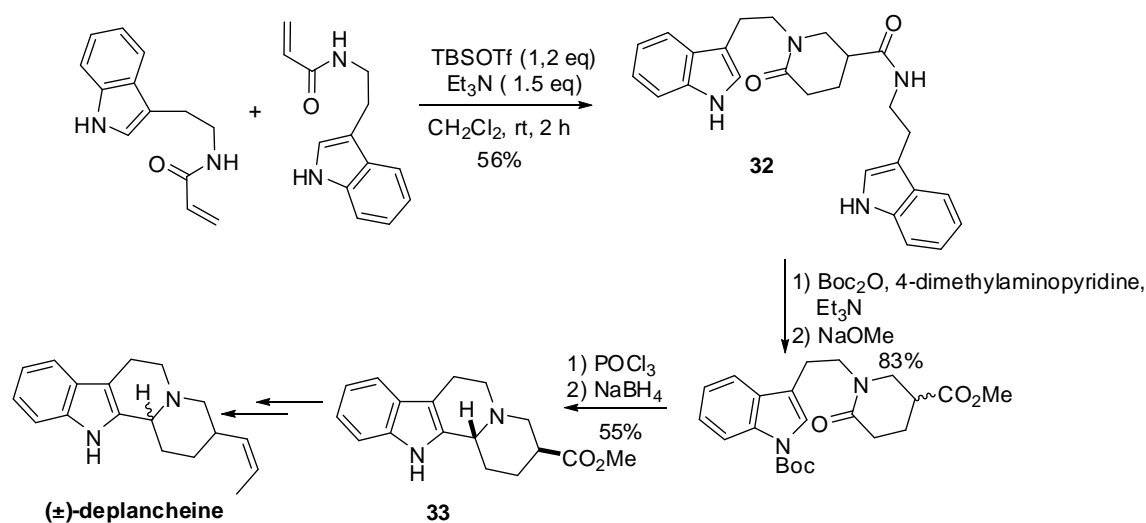

Scheme 27

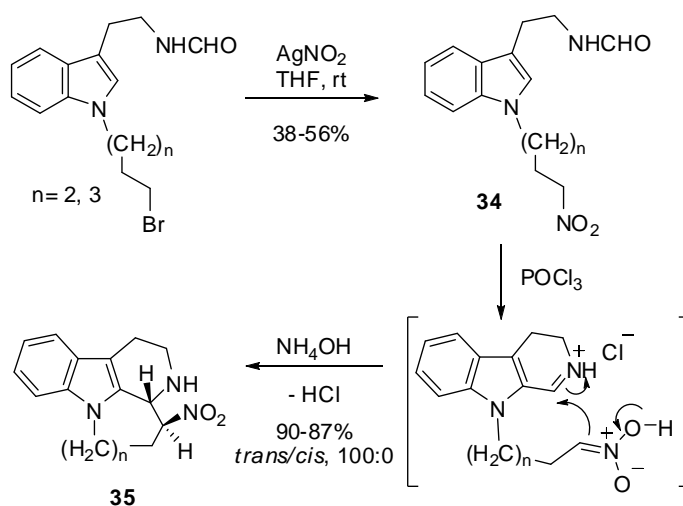

Scheme 28

Synthesis of annulated 1,2,3,4-tetrahydro- β -carbolines has been achieved in a single diastereoisomeric form and in high yields through a tandem BN-intramolecular aminoalkylation process starting from 2-[1-(ω -

nitroalkyl)-1*H*-indol-3-yl]ethylformamides **34** (Scheme 28). Compounds **35** are promising starting materials for indole alkaloid synthesis.⁶⁷

In principle, the asymmetric version of the BN reaction is carried out by combining the process with: (i) the stereoselective reduction of a 1-substituted 3,4-dihydro- β -carbolinium salt possessing a chiral auxiliary, (ii) nucleophilic additions to *N*-substituted- β -carbolinium salts, or (iii) by catalytic asymmetric hydrogenation with chiral organometallic complexes of the iminium salt. These approaches have been used mainly in tetrahydroisoquinoline synthesis, although some examples have appeared in the literature with β -carboline. Thus, L-(+)-tartaric acid has proved to be an effective chiral precursor in the asymmetric synthesis of β -carboline derivatives. Cyclization of amide **36** was carried out under modified BN conditions which consists of a conversion of the amide into a thioamide followed by methyl iodide-assisted cyclization.⁶⁸ The catalytic hydrogenation of **37** and acetylation of the intermediate gave compound **38** in 70% yield which was transformed into **39** (Scheme 29).⁶⁹

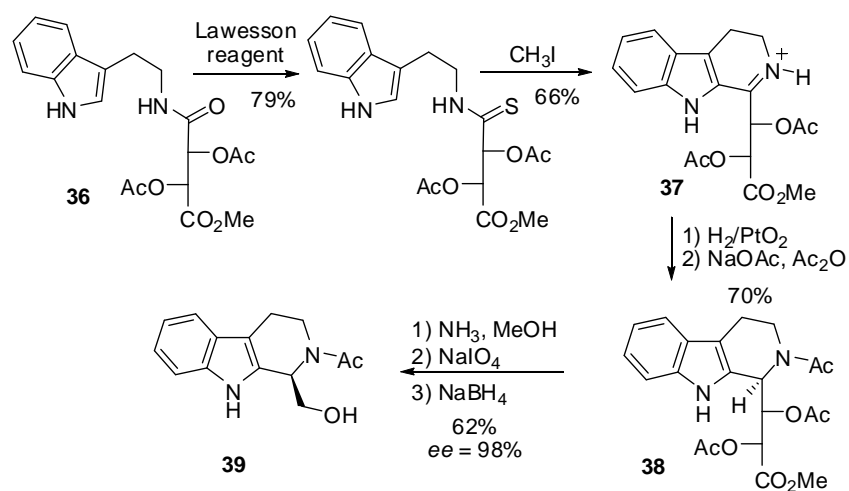

An example of asymmetric hydrogenation of the intermediate iminium salt was used recently for the synthesis of several natural alkaloids (Scheme 30). Thus, the condensation of butyrolactone with tryptamine afforded hydroxyamide **40** in 78% yield. Its subsequent treatment with POCl₃ gave unstable iminium salt **41** which was subjected to asymmetric transfer hydrogenation using (*S,S*)-**42** as the catalyst giving (+)-harmicine in 81% chemical yield.⁷⁰

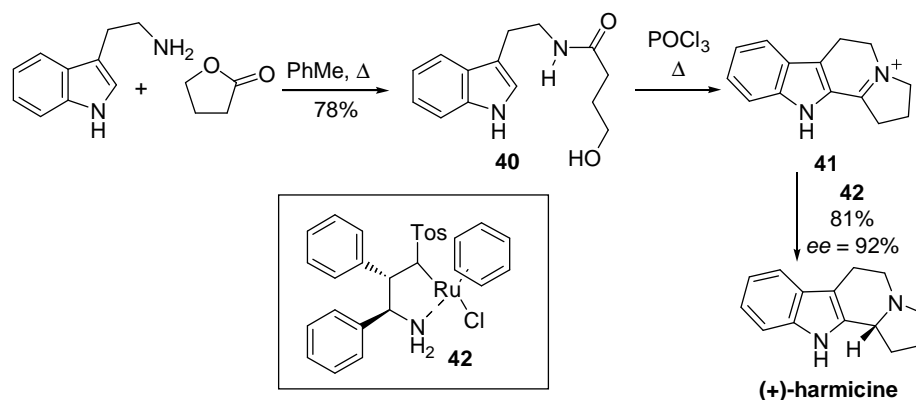

With certain formamides, an anomalous result was observed under BN reaction conditions. When *L-N*-formyl tryptophan methyl ester **43** was treated with POCl₃ at room temperature or under microwave irradiation, the unusual formation of β -carboline dimers **44** and **45** was observed (Scheme 31). Dimers **44** and **45** were acetylated separately with Ac₂O, both affording β -carboline **46**.⁷¹

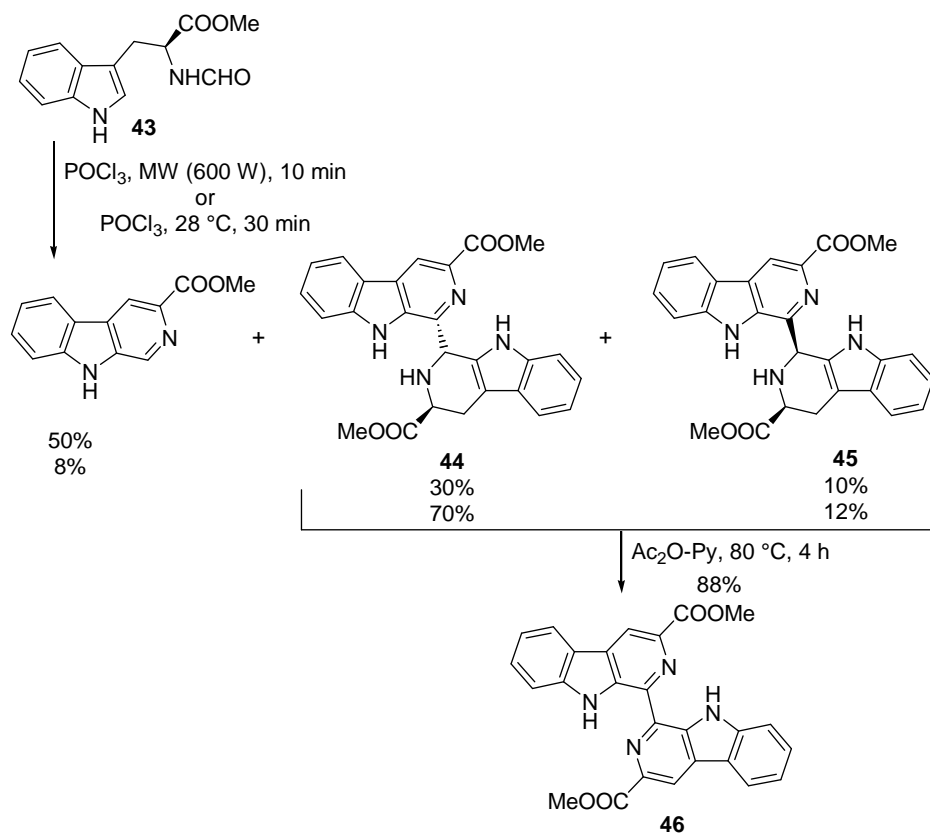

Scheme 31

2.3. Organometallic based methods

The limitations of PS and BN procedures, such as the requirement of harsh conditions and a restricted applicability to the synthesis of 4-substituted-tetrahydro- β -carbolines have encouraged the development of new and milder complementary protocols for the synthesis of polycyclic β -carbolines. Organometallic catalyzed reactions, mainly carbon-carbon coupling processes for the functionalization of indoles at C3 are the most used. Before addressing those contributions, a few works appeared using copper iodide to activate the cyclization of 3-alkynyl-2-*tert*-butylimines. Thus, a variety of 3-substituted β - and γ -carbolines have been synthesized from *N*-substituted-3-iodoindole-2-carboxaldehydes and 2-bromoindole-3-carboxaldehydes, respectively. Two different approaches were developed. The first one consisted of coupling of aldehydes **47** with various terminal acetylenes to afford the corresponding alkynylindole carboxaldehydes **48**, and then conversion to the corresponding *tert*-butylimines and cyclization to β -carbolines **49** by either copper-catalyzed or thermal processes.⁷² In the second approach, the palladium-catalyzed annulation of internal and terminal acetylenes by the pre-formed *tert*-butylimines **50** gave a general entry to β -carbolines **51**. This latter method gives two regioisomers of **51** when an unsymmetrical internal alkyne is employed (Scheme 32).⁷³

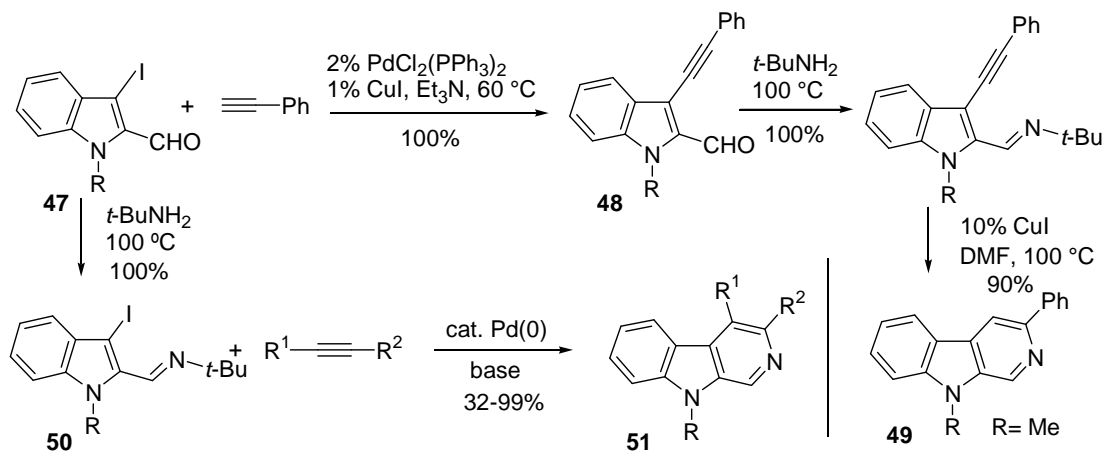

Scheme 32

Synthetic alternatives to the PS and BN reactions involving intramolecular alkylation of indoles at the C3 position are a promising complement for the synthesis of 4-substituted- β -carbolines. The first example of this C4-C4a disconnection was reported by Widenhoefer who obtained tetrahydro- β -carbolinone **53** by cyclization/carboalkoxylation of alkenyl indole **52** in the presence of palladium catalysts and 3 equivalents of Cu salts (Scheme 33). The protocol proceeds by a chemoselective 6-*exo*-trig ring-closure.⁷⁴

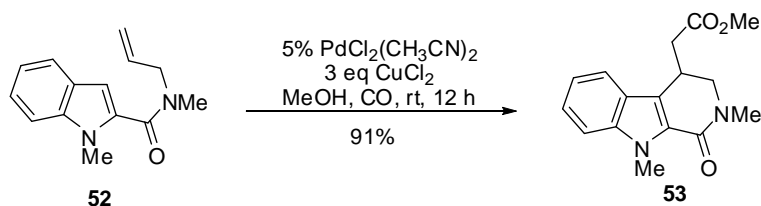

Scheme 33

A similar procedure but without carbonylation was developed by Broggini. His group has described numerous versions of Pd-catalyzed intramolecular cyclizations, such as intramolecular Heck cyclization from the corresponding 3-iodo-1*H*-indole-2-carboxylic acid allyl-amides and 2-iodo-1*H*-indole-3-carboxylic acid allyl-amides.⁷⁵ In a more recent work, these authors described a catalytic amination of a nonactivated double bond. Indole 2-carboxamide derivatives **54** underwent palladium-catalyzed intramolecular cyclization reactions to afford β -carbolinones **55** or pyrazino[1,2-*a*]indoles **56** according to different reaction pathways. Using PdCl₂(CH₃CN)₂ as catalyst and benzoquinone as reoxidant the reaction switched to the alternative cyclization path, giving β -carbolinone **55** as the predominant or exclusive product (Scheme 34).⁷⁶

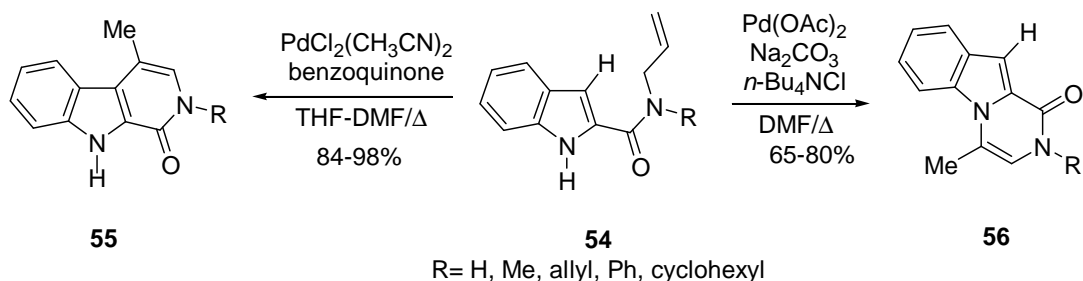

Scheme 34

Palladium-mediated intramolecular Heck cyclization was used as a new access to the tetracyclic tetrahydro- β -carboline framework of the ajmaline/sarpagine alkaloids (**58**). An aza-Diels-Alder reaction of 2-iodo-3-indole-acetaldehydes in the presence of zinc triflate [$\text{Zn}(\text{OTf})_2$] was used for the synthesis of the starting 2-(2-iodoindolylmethyl)-4-pyridones **57** (Scheme 35).⁷⁷

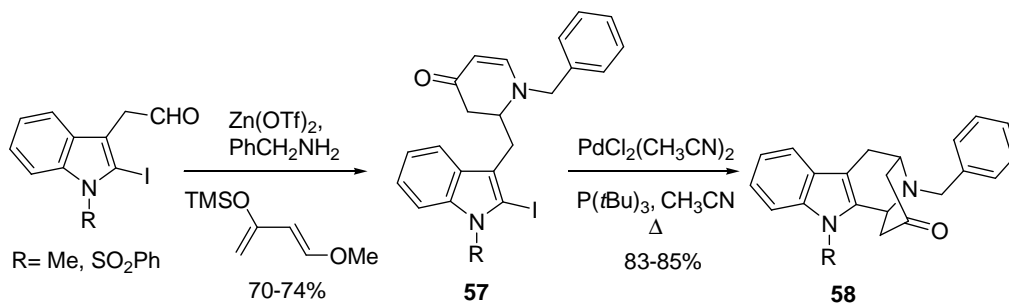

Scheme 35

The group of Bandini and Umani-Ronchi has been very active in the development of intramolecular Michael-type FC reaction for the synthesis of 4-substituted-tetrahydro- β -carbolines. They first reported on the effectiveness of InBr_3 as a Lewis acid catalysing intramolecular FC-type Michael conjugate addition of indole to enones giving racemic 4-functionalized-tetrahydro- β -carbolines.⁷⁸ Cross-metathesis reactions were used as a direct route to the cyclization precursors. Then, a stereocontrolled version of this cyclization using [salenAlCl] was carried out (*ee* of less than 27%) (Scheme 36).⁷⁹

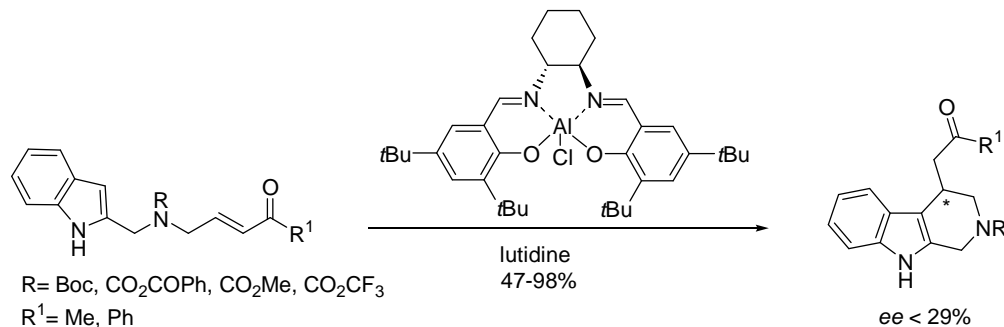

Scheme 36

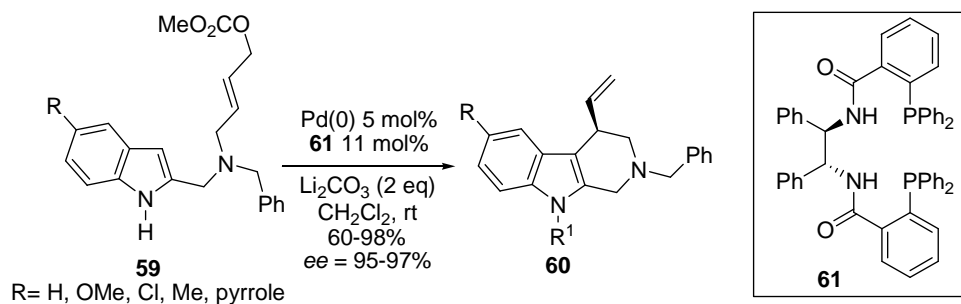

Scheme 37

The same group developed a Pd-catalyzed intramolecular allylic alkylation as an alternative procedure to conventional FC strategies. The optimized catalytic conditions allowed intramolecular allylic alkylation of

indolyl carbonate **59** with high yield that furnished regioselectively 4-vinyl- tetrahydro- β -carbolines **60** (Scheme 37).⁸⁰

The hot field of gold catalysis has recently entered the β -carboline chemistry. As gold salts are prone to coordinate with triple bonds, Padwa's group used a series of *N*-propargylindole-2-carboxamides **62** in AuCl₃-catalyzed cycloisomerization reactions to give β -carbolinones **63** in high yield. The corresponding β -chlorocarboline derivative was prepared and used for Pd(0)-catalyzed cross-coupling chemistry directed toward the synthesis of lavendamycin analogues **64** (Scheme 38).⁸¹

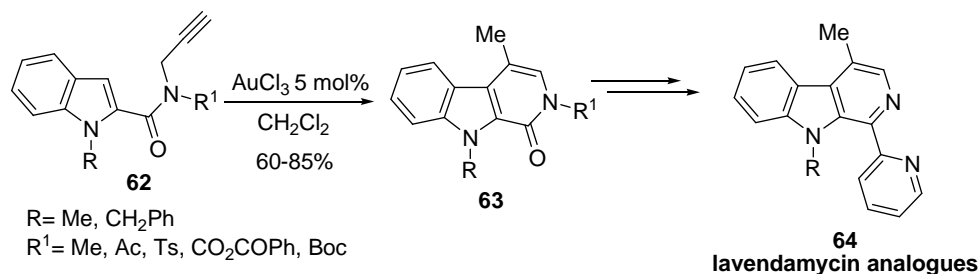

Scheme 38

2.4. Construction of the pyrrole ring

Most synthesis of the β -carboline system start from preformed indoles. However, some examples of the construction of the pyrrole ring as the key step for the synthesis of β -carbolines have appeared in the literature. The early examples by Queguiner⁸² and Boger⁸³ used amination reactions catalyzed by palladium salts to cyclize biaromatic compounds of type **65** (Scheme 39). These contributions are covered in previous reviews.²³

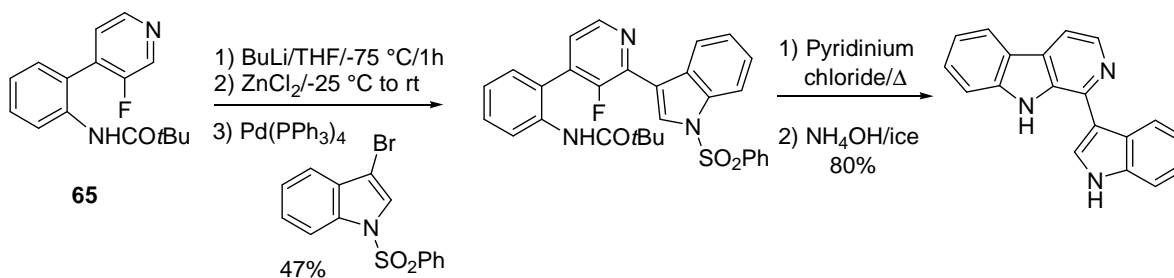

Scheme 39

A similar approach was used for the synthesis of two naturally occurring β -carbolines, 6-methoxy-2-methyl-1,2,3,4-tetrahydro- β -carbolines **66**, using a Stille-type coupling, followed by a palladium-phosphine catalyzed *N*-heteroannulation as the key steps (Scheme 40).⁸⁴

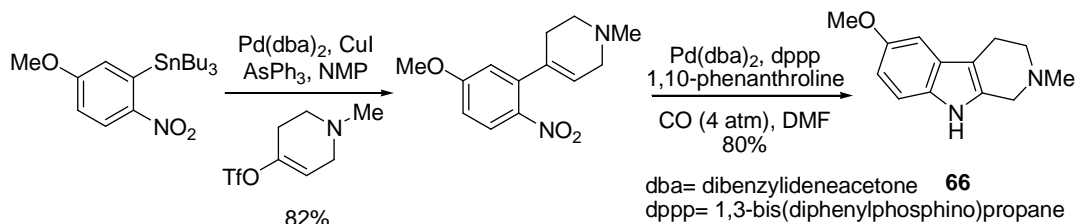

Scheme 40

More recently, (*S*)-brevicolline was synthesized in six steps from (*S*)-nicotine including a regioselective trisubstitution of the pyridine ring of nicotine, followed by successive Suzuki cross-coupling and Buchwald amination reactions. All along this synthesis, the configuration on the pyrrolidine ring was retained (Scheme 41).⁸⁵ A complementary approach used bromoenaminones derived from 1-substituted-3,5-piperidin-3,5-diones to reach 4-oxo-tetrahydro- β -carbolines *via* a palladium catalyzed cyclization.⁸⁶

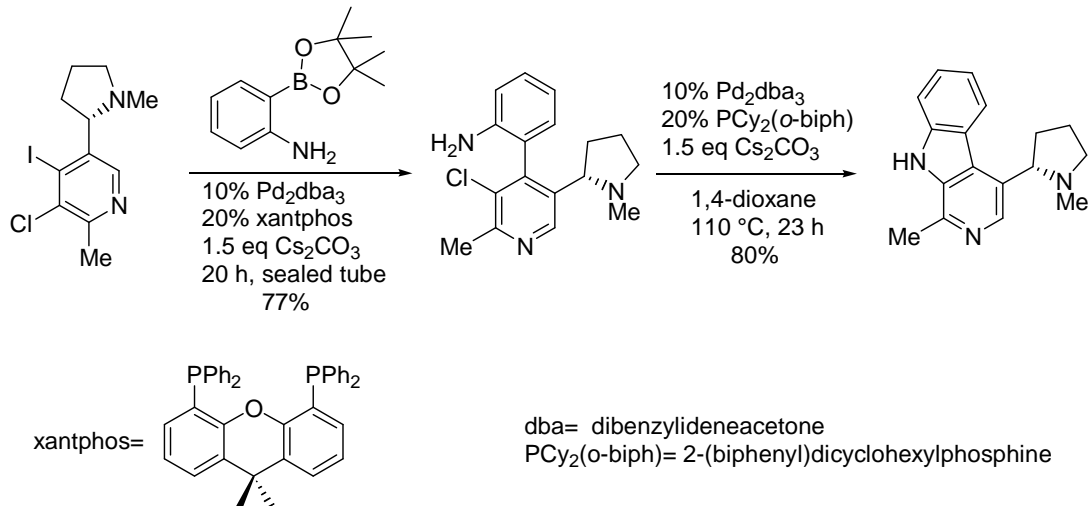

Scheme 41

Engler developed a new route to oxygenated carboline platforms. The process involved a Lewis acid directed cyclocondensation of piperidone enol ethers with 2-methoxy-4-(*N*-phenylsulfonyl)-1,4-benzoquinoneimine. This new indole approach was extended to the synthesis of β -carbolines starting from suitable functionalized substrates. The procedure needs the use of excess amounts of TiCl₄:Ti(OiPr)₄ (Scheme 42).⁸⁷

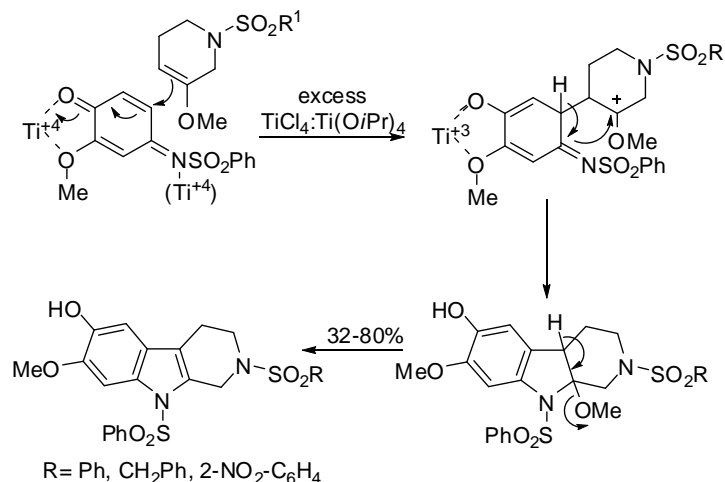

Scheme 42

Fischer indole synthesis with piperidine substituted hydrazines constitutes a classical alternative to these methodologies. In a recent example, 4-oxo- β -carboline derivatives were obtained by indolization of enehydrazine of 1-tosylpiperidine-3,5-diones (Scheme 43).⁸⁸

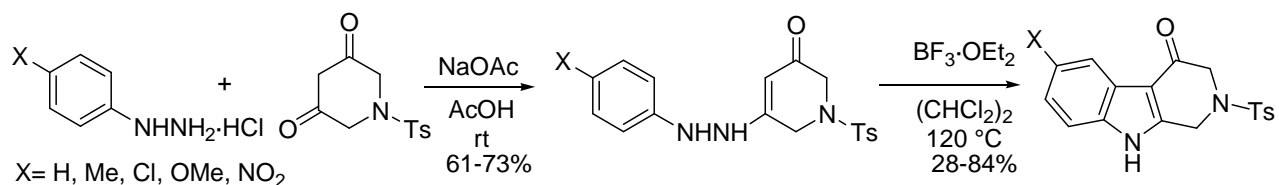

Scheme 43

In a very recent contribution a hydroformylation/Fischer indole synthesis, two component one-pot, of 2,5-dihydropyrroles and phenylhydrazines allowed access to tetrahydro-β-carbolines in moderate to good yields. As the building blocks were highly functionalized, flexible determination of the substitution pattern in the products is possible. The reaction sequence was regioselective in the hydroformylation step and selective in the migration of one of the two available positions (Scheme 44).⁸⁹

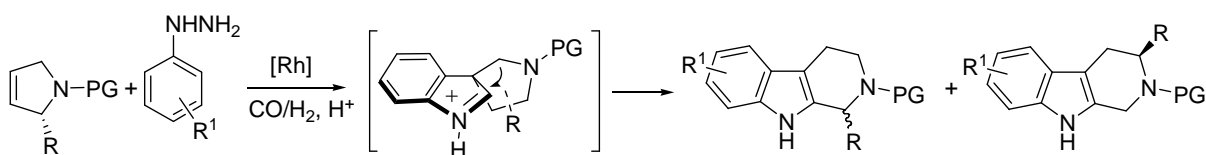

Scheme 44

2.5. Cycloaddition methodologies

Some methods have used cycloaddition strategies to prepare the β-carboline system. Thus, Snyder has developed a cycloaddition reaction of indoles with 1,2,4-triazines tethered from C3 to the indole nitrogen through an urea linker. The intramolecular inverse electron demand Diels-Alder cycloaddition gave the β-carboline (Scheme 45).⁹⁰ The same group used this strategy to access the canthine skeleton.⁹¹

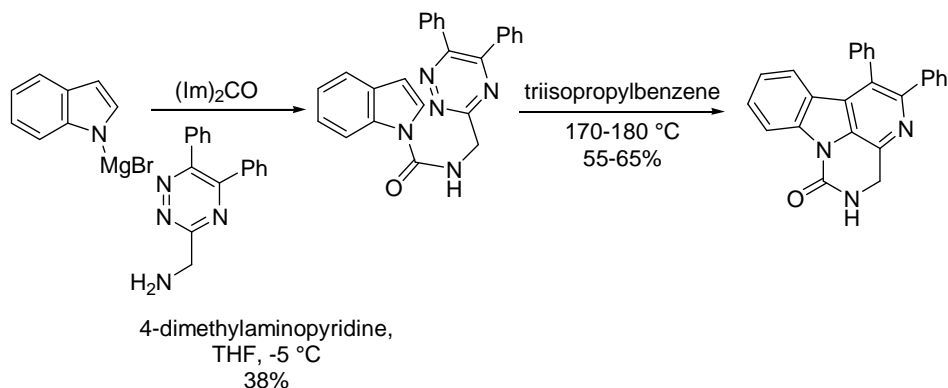

Scheme 45

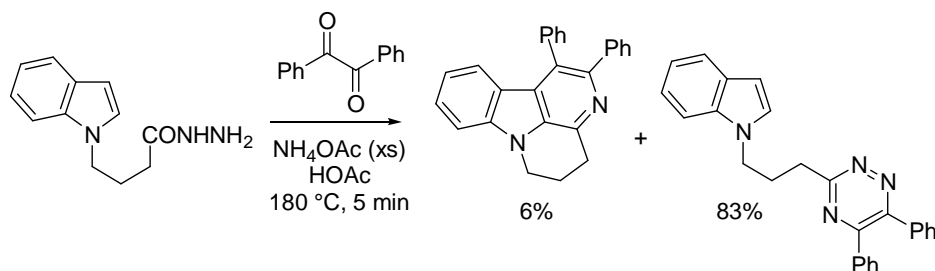

Scheme 46

More recently, a microwave-mediated protocol for the *one pot* synthesis of the canthine alkaloid skeleton was developed. The method provided high yielding access to a number of canthine and canthin-6-one alkaloids, reducing reaction times 10- to 700-fold over conventional thermal methods (Scheme 46).⁹²

2.6. Other strategies

A couple of works have appeared in recent years that use the C1-N2 disconnection for the synthesis of the β -carboline unit. Thus, functionalized imidazo- β -carboline ring systems **71** were constructed based on thermally or copper induced ring closure of ethyl 3-(4-amino-1-benzyl-1*H*-imidazol-5-yl)-1*H*-indole-2-carboxylate **70** (Scheme 47). Synthesis of **69**, precursor of **70**, was envisaged through coupling of imidzostannane **68** with 3-iodoindole **67**.⁹³

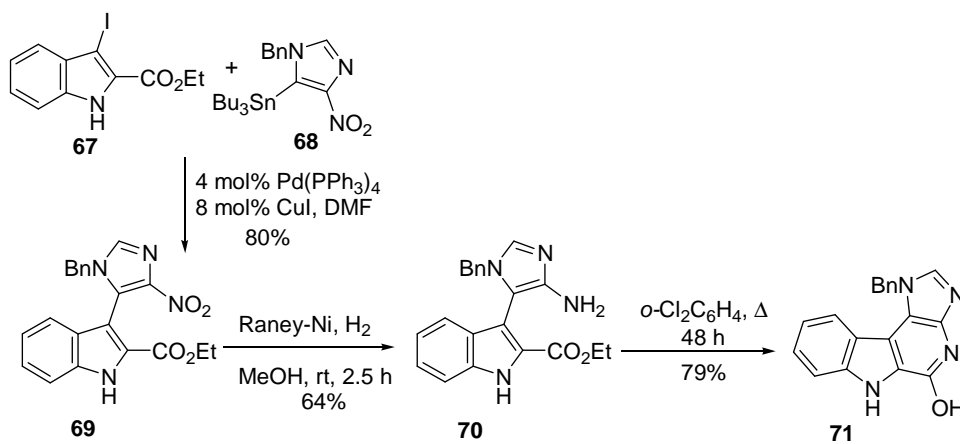

Scheme 47

The same approach was combined recently with an elegant synthesis of the starting materials. Indole and several C2 functionalized indoles were condensed with oxiranes, vinyloxiranes, aziridines and vinylaziridines in the solid state on the silica's surface. The yields of these reactions were superior to those carried out with Lewis acids in solution. This solid-phase aziridine opening was a key step in the synthesis of a β -carbolin-1-one mimic of pancratistatin (Scheme 48).⁹⁴

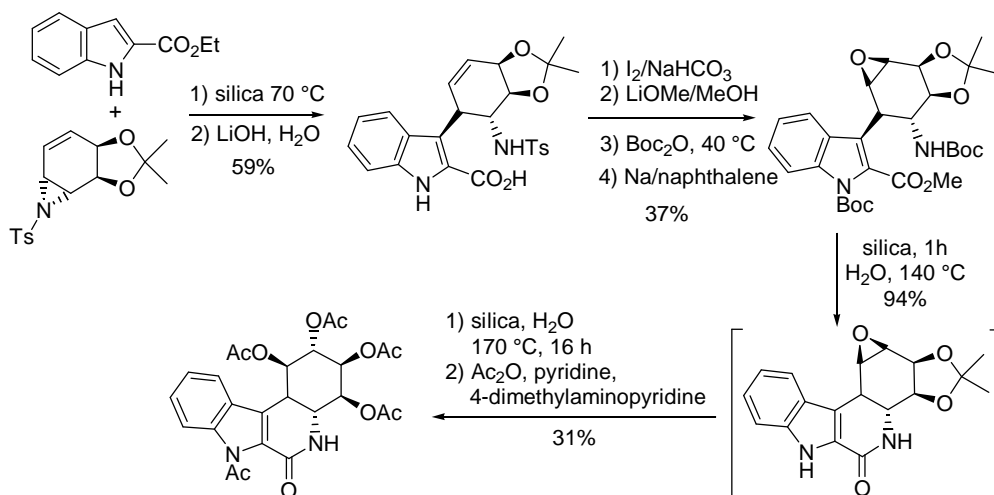

Scheme 48

We have already seen that the synthesis of 4-oxygenated β -carbolines is not easy, because the classical synthetic methods such as PS or BN reactions could not be applied. In addition to other approaches commented above, starting from elaborated indoles **72**, an acid mediated cyclization of **73** gave a series of 4-oxo-tetrahydro- β -carbolines **74** which were further oxidised (Scheme 49).⁹⁵

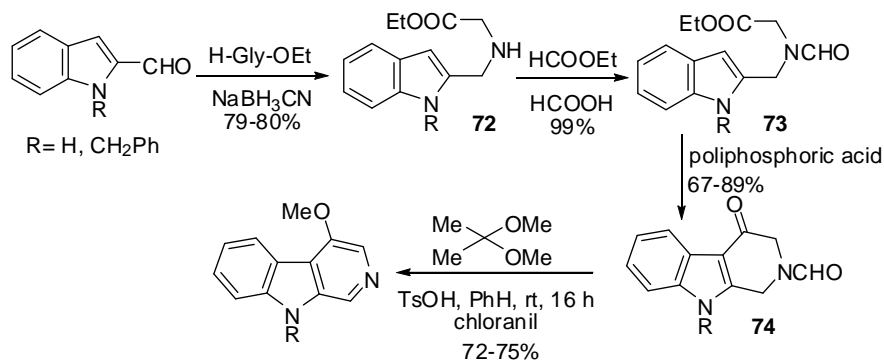

Scheme 49

There are a few routes in which electrocyclization reactions have been used for the synthesis of β -carbolines. Early examples by Molina used a tandem aza-Wittig/electrocyclic ring closure process to form 1-phenylacetyl- β -carboline (Scheme 50). The methodology was applied for the synthesis of the alkaloid xestomanzamine.⁹⁶

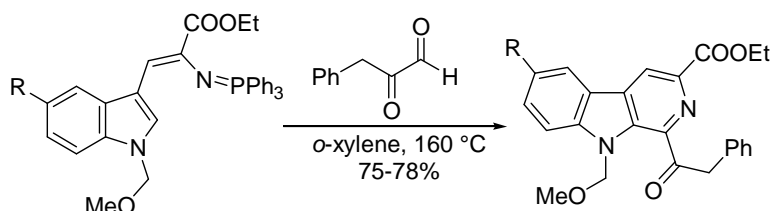

Scheme 50

More recently, electrocyclization reactions of monoazahexatriene systems were used as key steps for the synthesis of harman, harmine and their derivatives (Scheme 51).⁹⁷

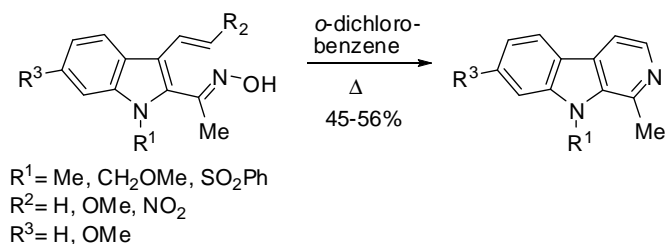

Scheme 51

Hiemstra and Rutjes recently reported the use of low loadings of $\text{Sn}(\text{OTf})_2$ as a catalyst for the formation of α -vinyl-substituted isoquinolines and β -carbolines in good yields *via* the allylic *N*-sulfonyliminium intermediate **75** (Scheme 52).⁹⁸

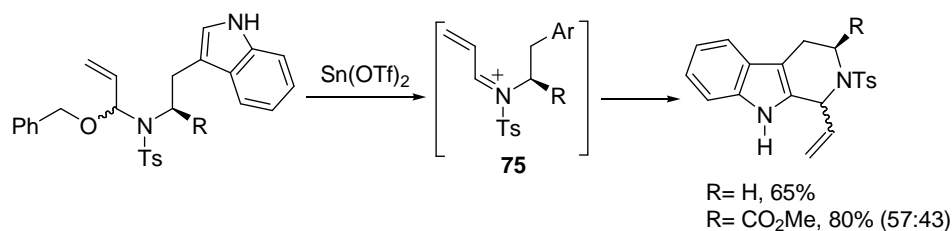

Scheme 52

The use of diketoindoles in the synthesis of carbazoles and β -carbolines was described by Cuny. The starting materials **76**, prepared by Friedel-Crafts acylations of 3-substituted indoles, were converted into β -carbolines **77** in good yields (Scheme 53). This method also allowed for the formation of 4-substituted β -carbolines.⁹⁹

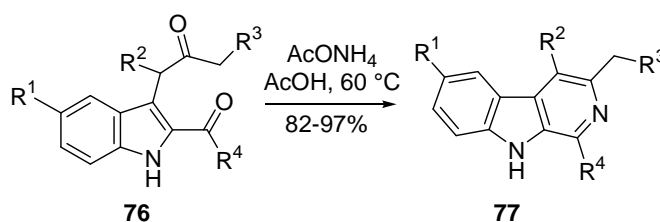

Scheme 53

Some syntheses of the β -carboline system use the N2-C3 disconnection approach, generally featuring an intramolecular nucleophilic substitution reaction of a good leaving group situated at C3.¹⁰⁰

3. Transformations of β -carbolines

Once we have reviewed the main methods for the construction of the β -carboline motif, it is interesting to consider the most significant transformations of these compounds. Obviously, β -carboline containing compounds have been submitted to a huge number of transformations, mainly included in total syntheses of natural products. Here we will show a few representative modifications of this system and we will focus on the transformation of the β -carboline system into other heterocycles or synthetically useful compounds, *i.e.* those cases in which the β -carboline is used as synthetic intermediate.

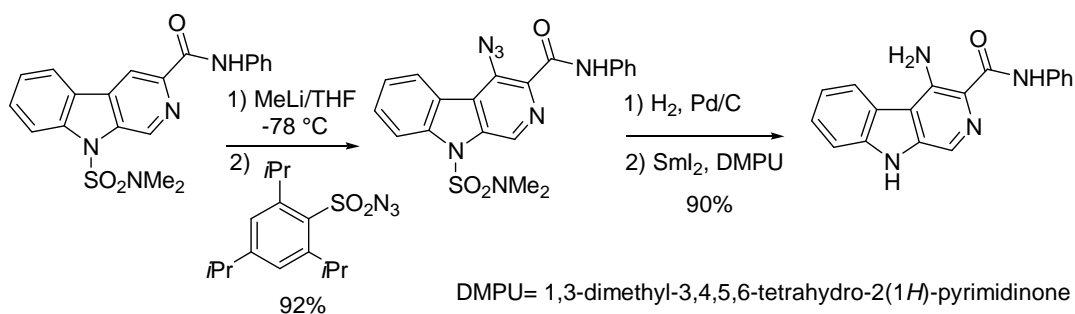

Scheme 54

Although the construction of tetrahydro- β -carbolines with substitution in positions 1-3 can be conveniently accomplished by adopting the PS or BN cyclization, obtaining 4-functionalized-tetrahydro- β -

carbolines still often requires multistep procedures. A new entry into 4-substituted derivatives was achieved by the introduction of the *N,N*-dimethylsulfamoyl moiety as a stable but easily removed blocking group for the 9-*N* position of 3-carboxy- β -carbolines. This allowed the preparation, *via ortho*-directed metalation techniques, of 4-substituted derivatives. As an example, the combination of *ortho*-directed metalation, palladium-catalyzed cross-coupling and SmI₂-promoted removal of the 9-*N*-protecting group was used to prepare 4-amino-3-carboxy- β -carboline derivatives (Scheme 54).¹⁰¹

In this context, Busacca described a useful approach to the preparation of 4-aryl, 4-alkyl and 4-carboxylate carboline derivatives *via* Pd-mediated cross-coupling of arylboronic acids and Grignard reagents to β -carboline **79**. This compound was obtained from **78** by selective oxidation of THBC and aromatization of the pyridine (Scheme 55).¹⁰²

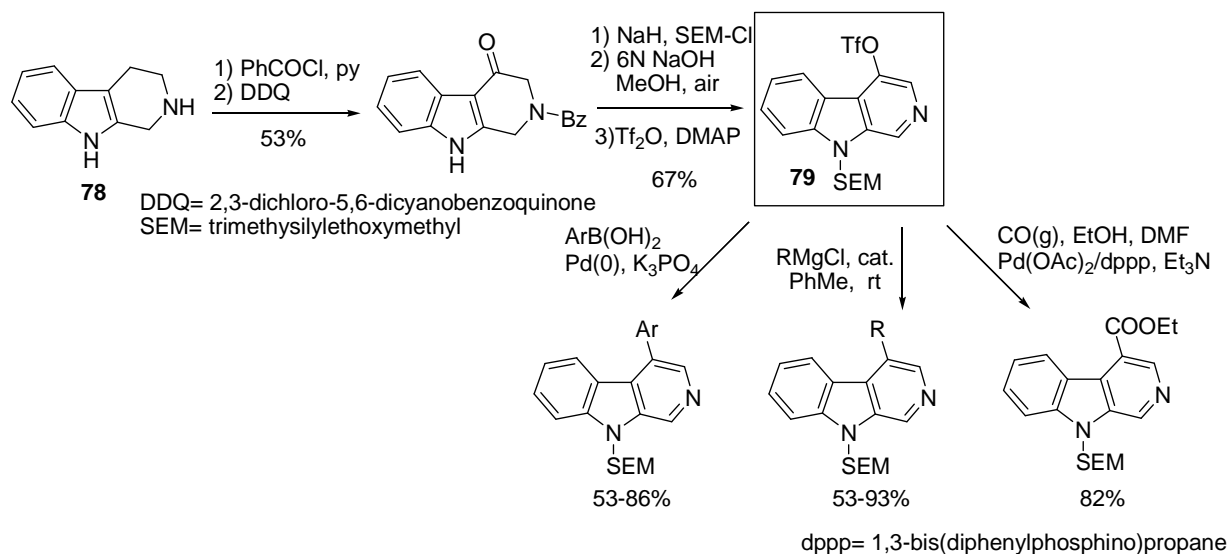

Scheme 55

A few dipolar cycloadditions have been reported. Thus, azomethine ylides derived from β -carbolines can be effectively generated by fluoride ion-induced desilylation of 2-*N*-[(trimethylsilyl)methyl] triflate salts. These ylides undergo *in situ* [3+2] dipolar cycloaddition reactions with electron-deficient olefins and acetylenes to give indolizino[8,7-*b*]indoles (Scheme 56). Yields of cycloaddition products were only satisfactory using 3,4-dihydro- β -carbolines and the reaction gave most times mixtures of regio- and diastereomers.¹⁰³

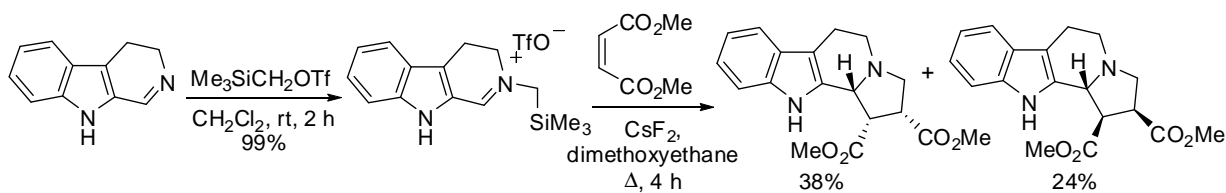

Scheme 56

Recently, 1,7-electrocyclization of azomethine ylides was used to afford benzo[5,6]azepino[2,1-*a*]- β -carbolines from 1-vinyl-2-substituted-dihydro- β -carbolinium ions.¹⁰⁴

One of the first reports regarding these cycloadditions was the 1,3-dipolar cycloaddition reaction of 3,4-dihydro- β -carboline 2-oxide **80** with different dipolarophiles giving mixtures of *cis* and *trans* cycloadducts.¹⁰⁵ The authors have published recently a NMR study on the thermal stereo-isomerization between *cis* and *trans* 1,3-di-cycloadducts **81** (Scheme 57).¹⁰⁶

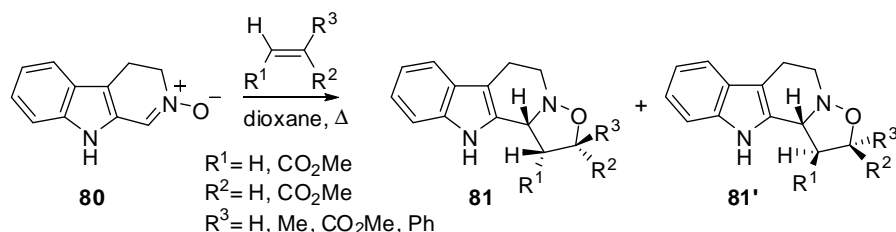

Scheme 57

β -Carbolines obtained through a PS reaction were further functionalised using Pd catalyzed reactions with allene and with carbon monoxide providing rapid access to a range of tetrahydro- β -carboline derivatives *via* intramolecular trapping of intermediate π -allyl- and acyl-palladium(II) complexes by the indolic or secondary amino moieties. Fused azepine and δ -lactam derivatives were synthesized (Scheme 58).¹⁰⁷

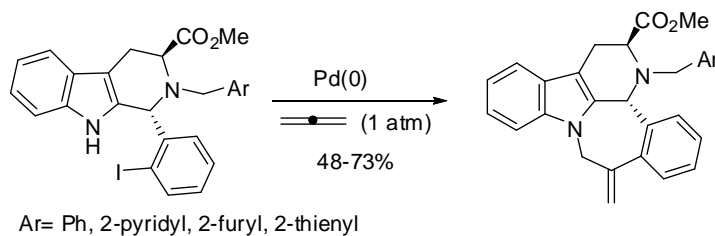

Scheme 58

Another approach devoted to the formation of additionally fused cycles to the β -carboline is the cyclization of nitro-aryl substrates using SnCl₂ (Scheme 59). The mechanistic course of the reaction suggests the involvement of a hydroxylamine intermediate leading to an intramolecular cyclization *via* N-N bond formation.¹⁰⁸



Scheme 59

The synthesis of fused polycyclic-nitrogen containing heterocycles to the β -carboline system *via* cascade cyclization was carried out by condensation of 1-(2-aminophenyl)-9H- β -carboline-3-carboxamide with isothiocyanates followed by *in situ* treatment of the resulting thioureas with HgCl₂ (Scheme 60).¹⁰⁹

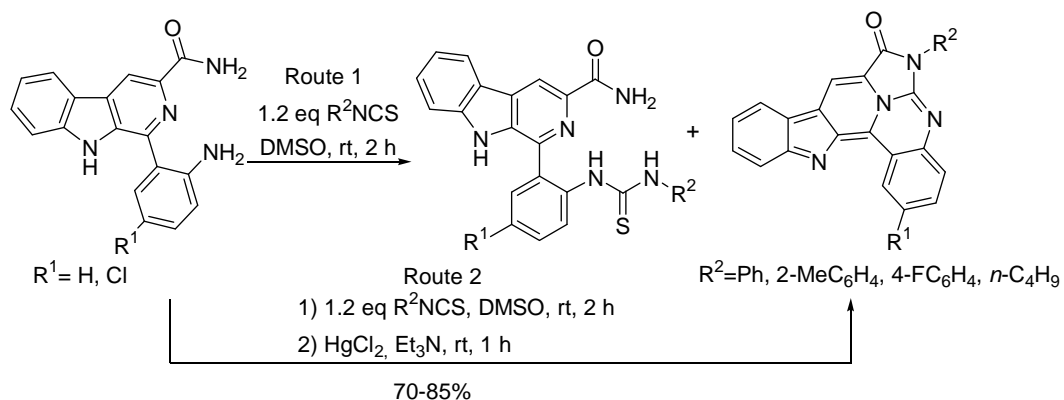

Scheme 60

3.1. Oxidations

The Winterfeldt reaction is an important transformation that converts β -carbolines into pyrroloquinolones, a structure present in numerous biologically active compounds. This reaction is generally carried out with strong bases such as NaH or KO t -Bu.¹¹⁰ Substrates bearing functional groups sensitive to strong bases can be oxidised following a recently reported procedure, which uses potassium superoxide. This alternative oxidation reagent was found to be superior to the original Winterfeldt protocol for base-sensitive substrates (Scheme 61).¹¹¹

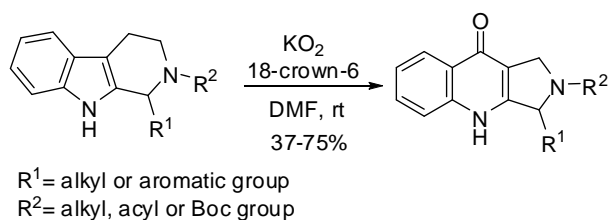

Scheme 61

3.2. Reductions

Many natural products contain 1-substituted- β -carbolines and thus synthesis of enantiomerically pure forms of these products have been an important synthetic challenge. Two main strategies are found in the literature: asymmetric alkylation of C1 using organocatalytic methodologies or from β -carbolines bearing chiral auxiliaries, or asymmetric hydrogenation, which offers one of the most versatile and elegant tool with respect to selectivity, generality and atom efficiency. Tietze reported a desymetrization approach in which simple racemic C1 substituted-tetrahydro- β -carbolines were oxidised with potassium permanganate and hydrogenated in formic acid/triethylamine with the Ru catalyst **82**. The products were obtained in good yields and 95–99% *ee*. Since both (*R,R*)-**82** and (*S,S*)-**82** are available, (*1S*)-tetrahydro- β -carbolines as well as their enantiomers can be prepared (Scheme 62).¹¹²

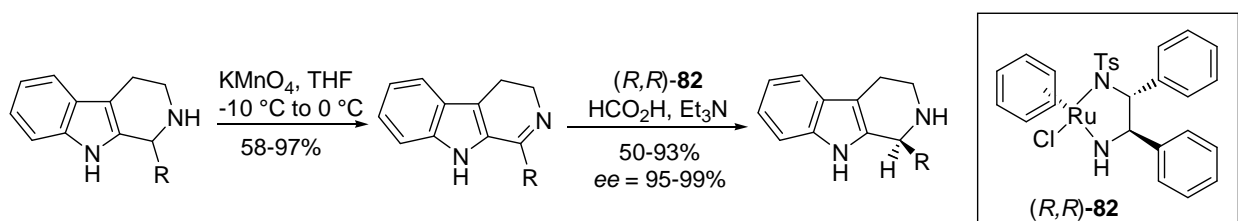

Scheme 62

Indeed, catalytic transfer hydrogenation has been well established by Noyori's group¹¹³ and others¹¹⁴ for the synthesis of tetrahydro- β -carbolines. These ruthenium-catalyzed transfer hydrogenation of dihydro- β -carboline imines in the presence of Noyori or Noyori-based catalysts give enantioselectivities of >99% *ee* with formic acid as the hydrogen source. Furthermore, Morimoto reported the catalytic reduction of similar substrates with molecular hydrogen in the presence of iridium diphosphane complexes, reaching 95% *ee*.¹¹⁵ In a very recent report, different dihydro- β -carboline derivatives were submitted to rhodium-catalyzed asymmetric hydrogenation in the presence of chiral phosphorus ligands (Scheme 63). Enantioselectivities of up to 99% *ee* were obtained after ligand screening and optimization of the reaction conditions.¹¹⁶

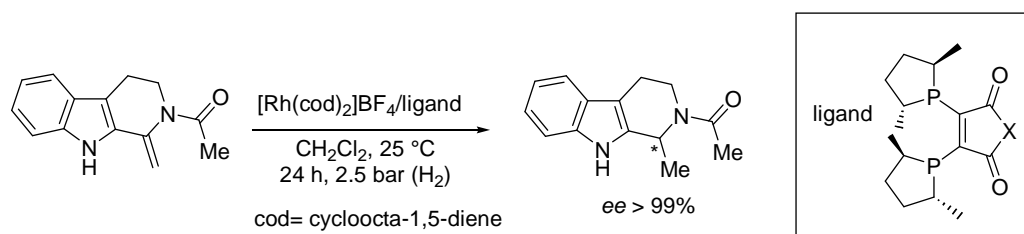

Scheme 63

An alternative to the above methods is the asymmetric reduction of dihydro- β -carboline derivatives to the corresponding tetrahydro- β -carboline based on the supramolecular complex formed from calix[6]arene/chiral amine as an enzyme mimetic and NaBH₄ as the reducing agent (Scheme 64).¹¹⁷

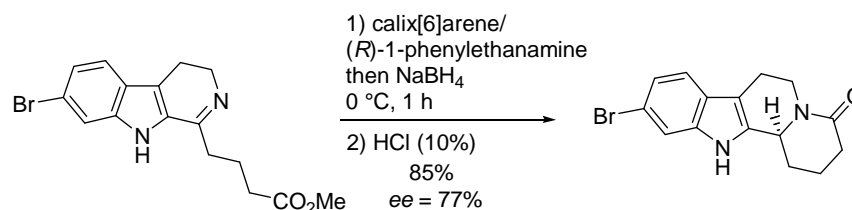

Scheme 64

3.3. Stereoselective alkylations

The alternative way to reach enantiomerically enriched or pure tetrahydro- β -carbolines is to effect an asymmetric alkylation. Early examples included nucleophilic addition of chiral enolates to iminium ions bearing chiral groups (Scheme 65).¹¹⁸

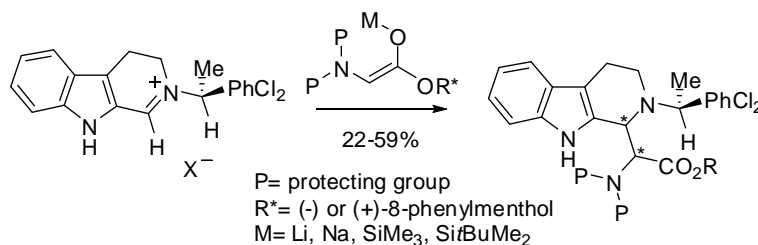

Scheme 65

Another chiral auxiliary, this time derived from 2,3,4,6-di-*O*-isopropylidene-2-keto-*L*-gulonic acid, was used to induce asymmetry and activate the lithiation of C1 and subsequent alkylation with alkyl halides giving 1-substituted-tetrahydro- β -carbolines (Scheme 66).¹¹⁹

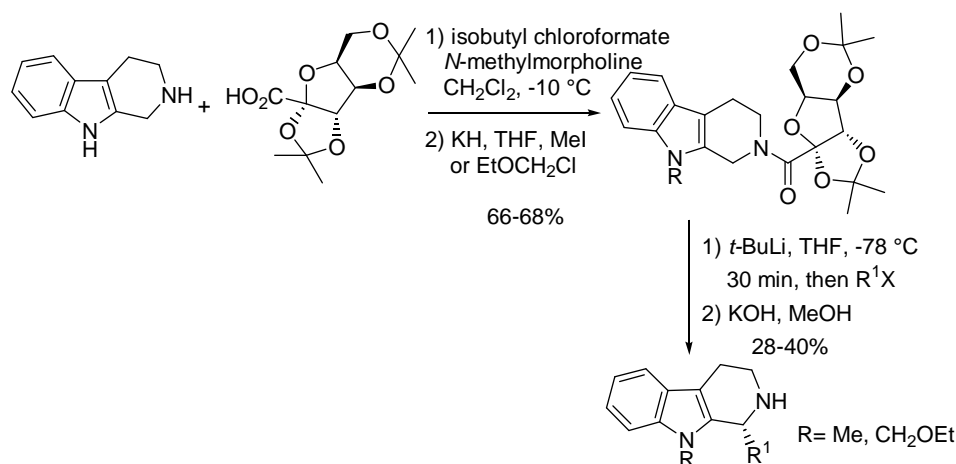

Scheme 66

Similarly, β -carbolines acylated at N2 with a proline derived group gave diastereoselectively 1-allyl-1,2,3,4-tetrahydro- β -carbolines upon reaction with allyltributyltin as reported by Itoh. The stereochemical outcome of this reaction was reversed using tetraallyltin, giving an entry into both enantiomers of 1-allyl-1,2,3,4-tetrahydro- β -carboline after elimination of the chiral auxiliary and reduction.¹²⁰ A similar chiral auxiliary, *i.e.* a pyroglutamic acid was also linked to the N9 position. In this case, reaction with a silyl enol ether in the presence of 2,2,2-trichloroethyl chloroformate gave 1,2-addition product **83** (Scheme 67). Changing the protecting group of the pyroglutamic ring from alkyl to acyl lead to the opposite configuration of the final product.¹²¹ Enantioselective syntheses of various alkaloids were carried out using this methodology.¹²²

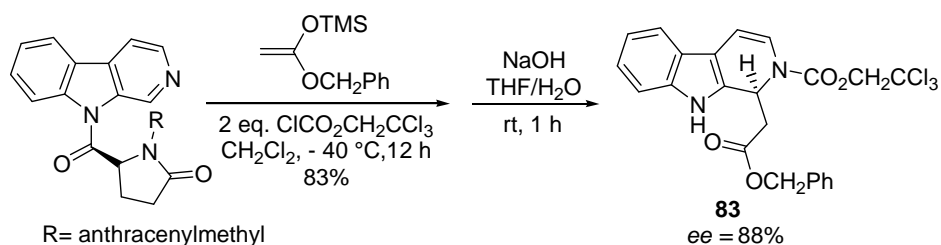

Scheme 67

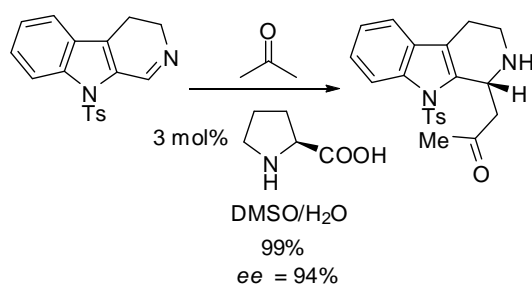

Scheme 68

Finally, the same group developed an organocatalyzed version of their approach. Asymmetric reactions catalyzed by metal-free chiral organic compounds have become a rapidly expanded research area in organic synthesis being the proline-catalyzed asymmetric reaction among the most useful processes. Thus,

they performed a catalytic asymmetric addition reaction of 3,4-dihydro- β -carbolines using (*S*)-proline as the chiral catalyst reaching high chemical yields and *ee*. In the process, a small amount of water was found to affect the stereoselectivity of the products (Scheme 68).¹²³

3.4. Metathesis

The metathesis reaction is another powerful method to generate additional cycles fused or linked to β -carbolines. The first examples of Ring Closing Metathesis (RCM) were performed on enamines derived from β -carbolines.¹²⁴ Recently, this reaction was used for the synthesis of azabicyclo[*m.n.1*]alkenes (*m*=3–5; *n*=3–2). The procedure consists of a RCM of *cis*-2,6-dialkenyl-*N*-acyl-piperidine derivatives, which were readily prepared from glutarimide or 4-methoxypyridine.¹²⁵ In the same paper, a new route for the construction of the bridged tetrahydro- β -carboline structures **85**, that features the ring-closing metathesis of the enyne **84**, was described. The compound **85** may serve as a key structural subunit in the synthesis of complex indole alkaloids of the *Sarpagine* and *Ajmaline* families (Scheme 69).

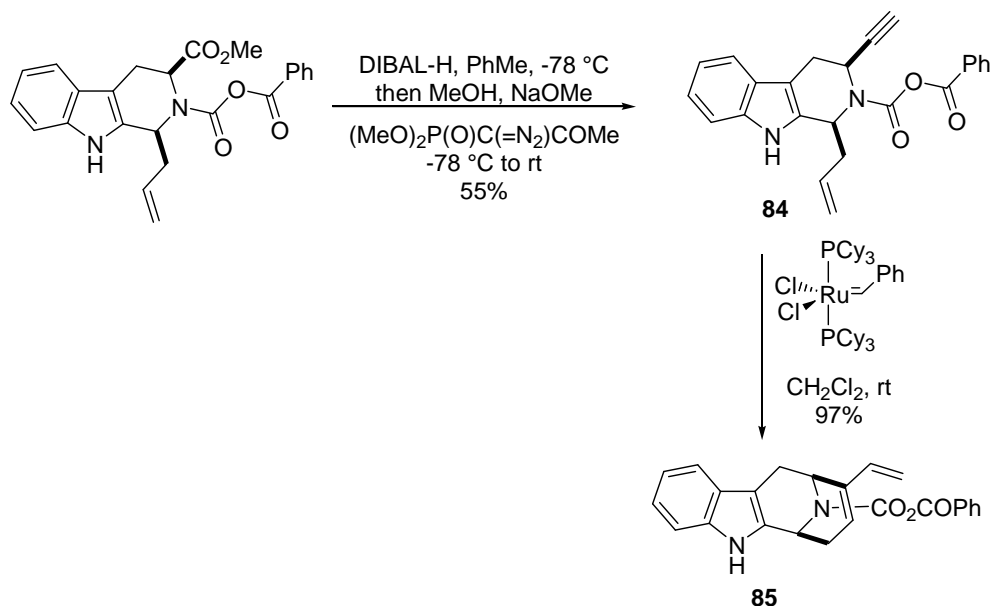

Scheme 69

We have shown recently that enynes and dienynes, based on the β -carboline system, give metathesis products with ruthenium catalysts. The enyne RCM of compound **86** resulted in the formation of the pyrrole **88** in addition to the desired diene **87** (Scheme 70).¹²⁶

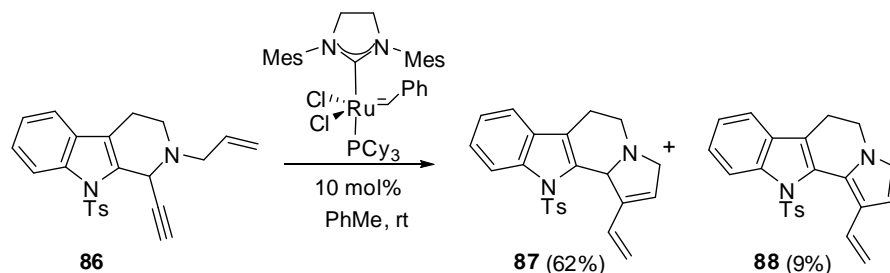

Scheme 70

3.5. Reactions with activated alkynes

Tetrahydro- β -carbolines react with activated alkynes giving interesting rearrangements that lead to other heterocyclic systems. In an early report of this reactivity, compounds **89** reacted with one molecule of activated alkyne (dimethylacetylenedicarboxylate) to give, depending on the solvent, either enamines **90** or heterocyclic derivatives **91,92** (Scheme 71). The enamines **90** can be quantitatively transformed into **91,92**. The application of acidic or basic catalysis determined the position of the double bond in the pyrrole ring.¹²⁷

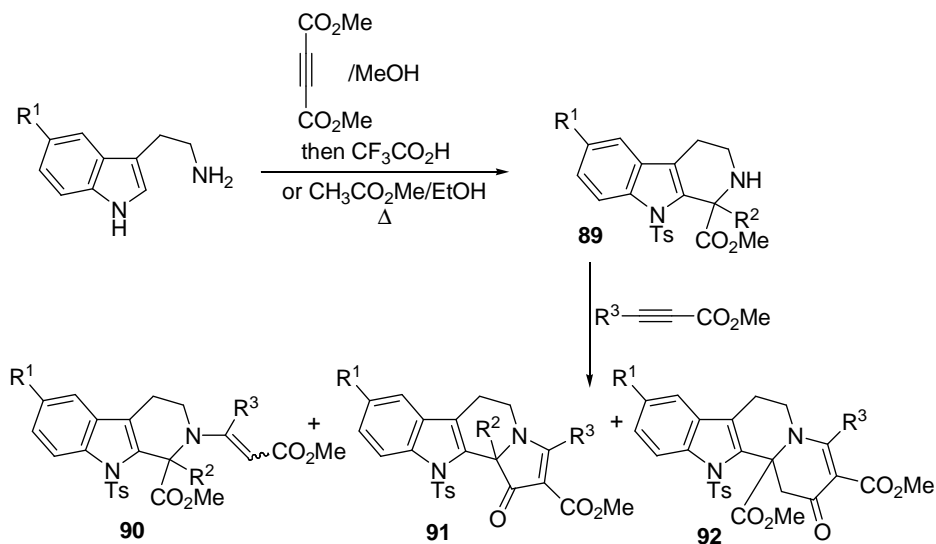

Scheme 71

Voskressensky has reported various reactions of tetrahydro- β -carbolines and other heterocycles with activated alkynes. Thus, tetrahydro- β -carbolines produced biologically active tetrahydroazocino [4,3-*b*]indoles **93,94** directly upon treatment with dimethyl acetylenedicarboxylate or ethylpropiolate in ethanol, respectively (Scheme 72). The reaction begins with the nucleophilic attack to the alkyne that behaves as a Michael acceptor and subsequent reaction of the intermediate with carbon α to the nitrogen at the carboline system. This transformation required the presence of methanol to stabilize the intermediate.¹²⁸

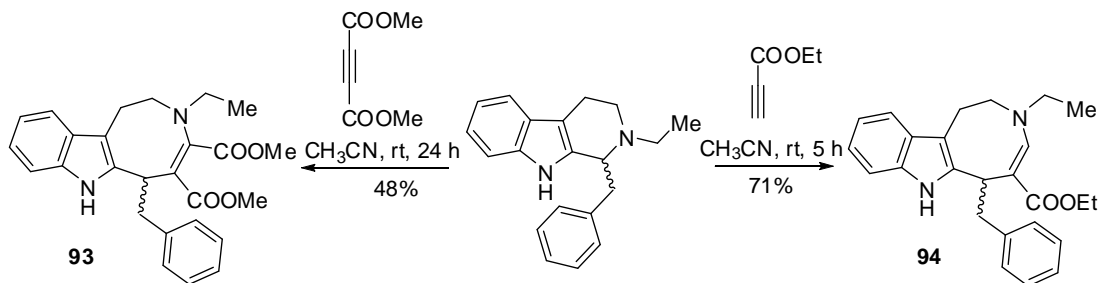

Scheme 72

We have shown recently that vinylpyrrolo-[2,1-*a*]- β -carbolines **95** give different products upon reaction with dienophiles. With dimethyl acetylenedicarboxylate, a novel domino process takes place, involving Michael attack and rearrangement, affording complex polycycles like **96** and **97**. Diels-Alder cycloadditions are favored in the presence of Lewis acids and are the only reactions with dimethyl maleate.

When 3-butyn-2-one is used as dienophile, a Stevens rearrangement is observed giving product **98** (Scheme 73).¹²⁹

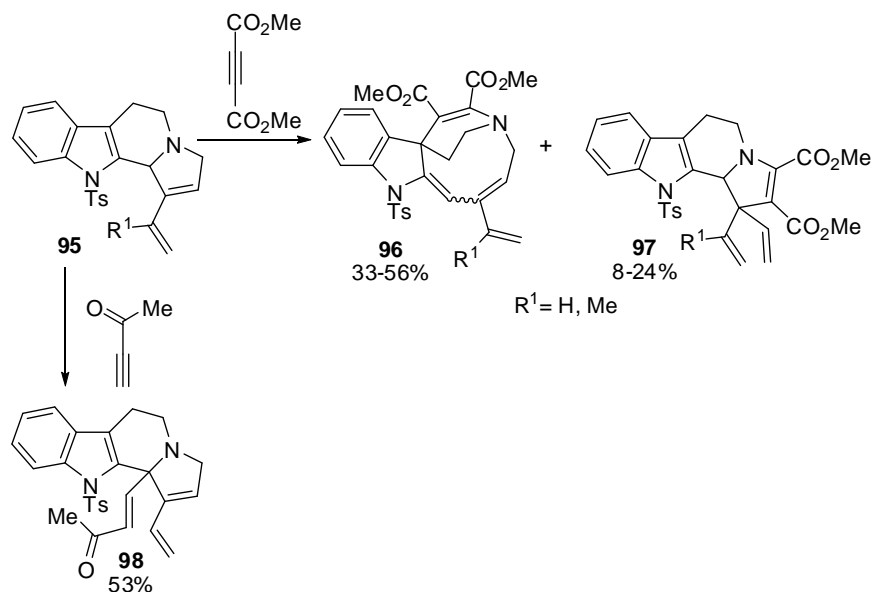

Scheme 73

3.6. β -Carbolines as chiral ligands

1,2,3,4-Tetrahydro- β -carboline amino acid esters, derived from a natural alkaloid, act as chiral ligands, in the addition of diethylzinc to benzaldehyde. The enantioselectivities of the resulting 1-phenyl-1-propanol were, in most cases, related to the conformational populations of the free ligand (Scheme 74).¹³⁰

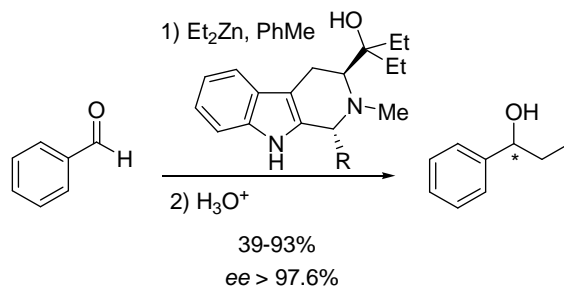

Scheme 74

4. Total syntheses of natural alkaloids containing the β -carboline system

It is not the aim of this review to cover the vast number of reports dedicated to the total synthesis of natural products, mainly indole alkaloids, containing the β -carboline skeleton. We will just outline some very recent and impressive syntheses, highlighting the methodology used for the construction of the β -carboline and we will summarize the literature dedicated to the total syntheses of β -carboline alkaloids of the last ten years.

The total synthesis of several members of the *vinca* and *tacaman* classes of indole alkaloids has been accomplished recently. The central step in the synthesis consists of an intramolecular [3+2]-cycloaddition reaction of a α -diazo indoloamide which delivers the pentacyclic skeleton of the natural product in excellent

yield. A base induced keto-amide ring contraction was utilized to generate the E-ring of the natural product (Scheme 75).¹³¹

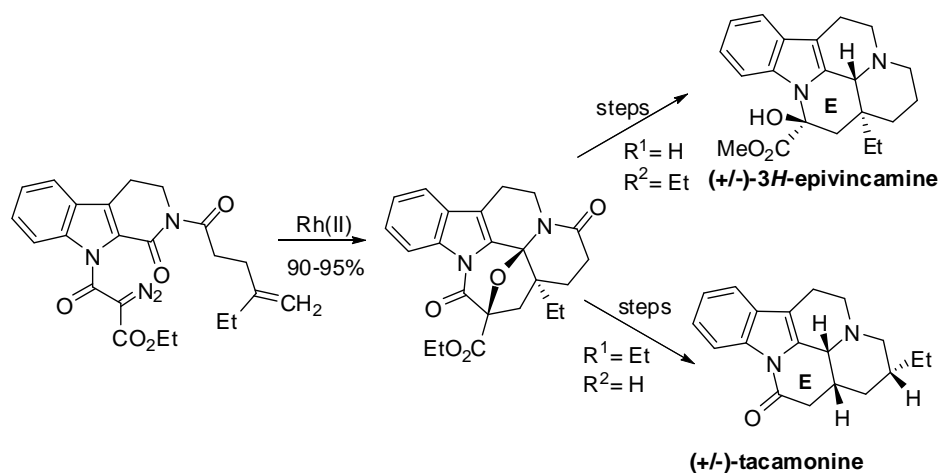

In another recent contribution, a stereoselective total synthesis of suaveoline and norsuaveoline was presented. Central features of the synthetic strategy were the conversion of L-tryptophan methyl ester **99** into the oxazole derivative **100**, subsequent BN reaction to give **101** and the intramolecular Diels-Alder reaction of the oxazole-olefin **102** leading to the pentacyclic pyridine derivative suaveoline with 10% overall yield (Scheme 76).¹³²

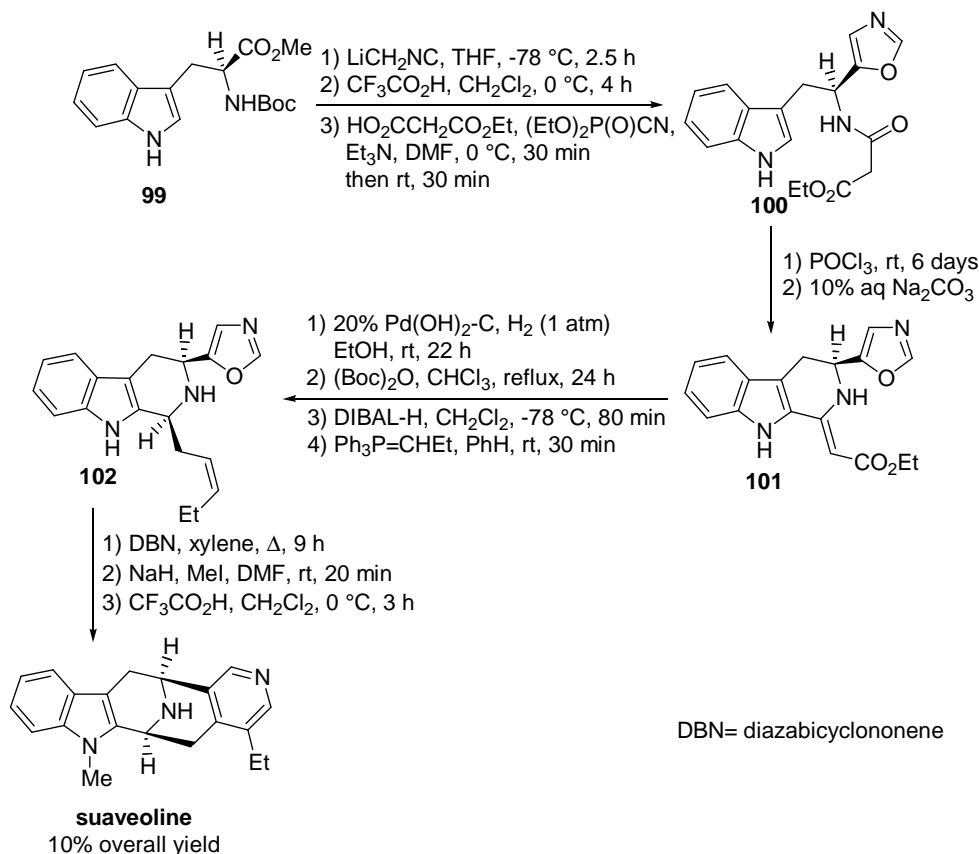

A BN reaction was also the choice for the construction of the β -carboline in a total synthesis of the corynanthe alkaloid dihydrocorynantheol and the formal syntheses of the indole alkaloids tacamonine, rhynchophylline and hirsutine. The strategy comprised the construction of variously substituted piperidinone D-rings *via* RCM followed by a 1,4-addition of organocuprates to introduce the requisite side chain at C15 (Scheme 77).¹³³

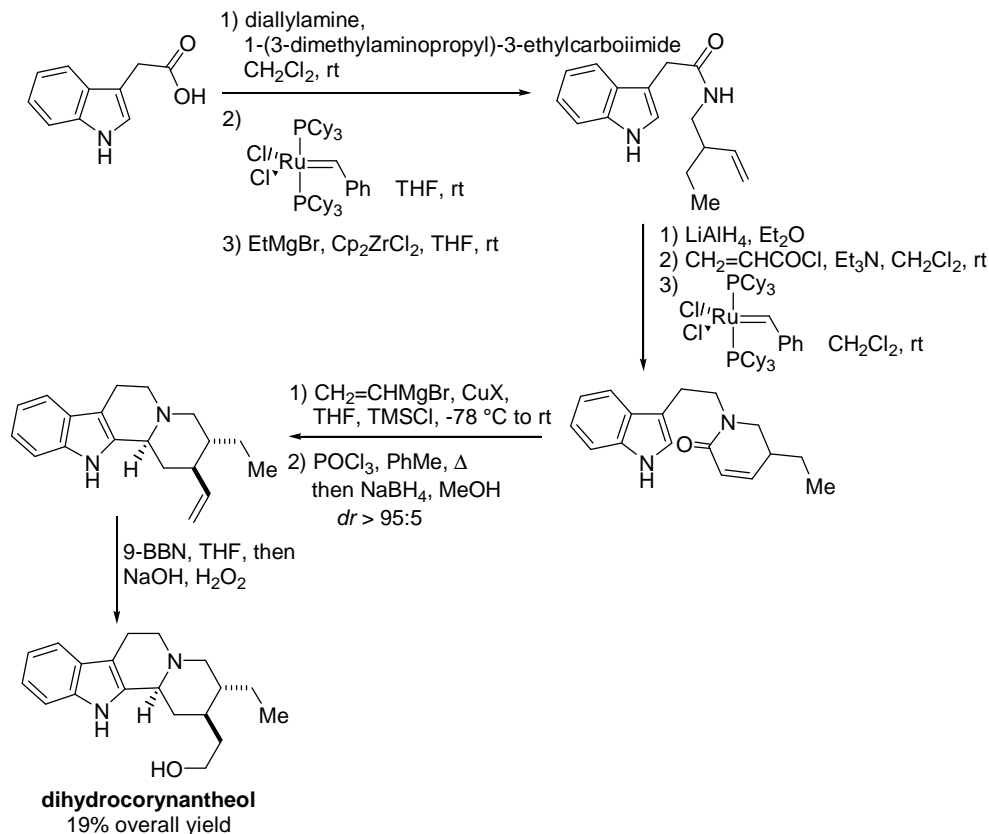

Scheme 77

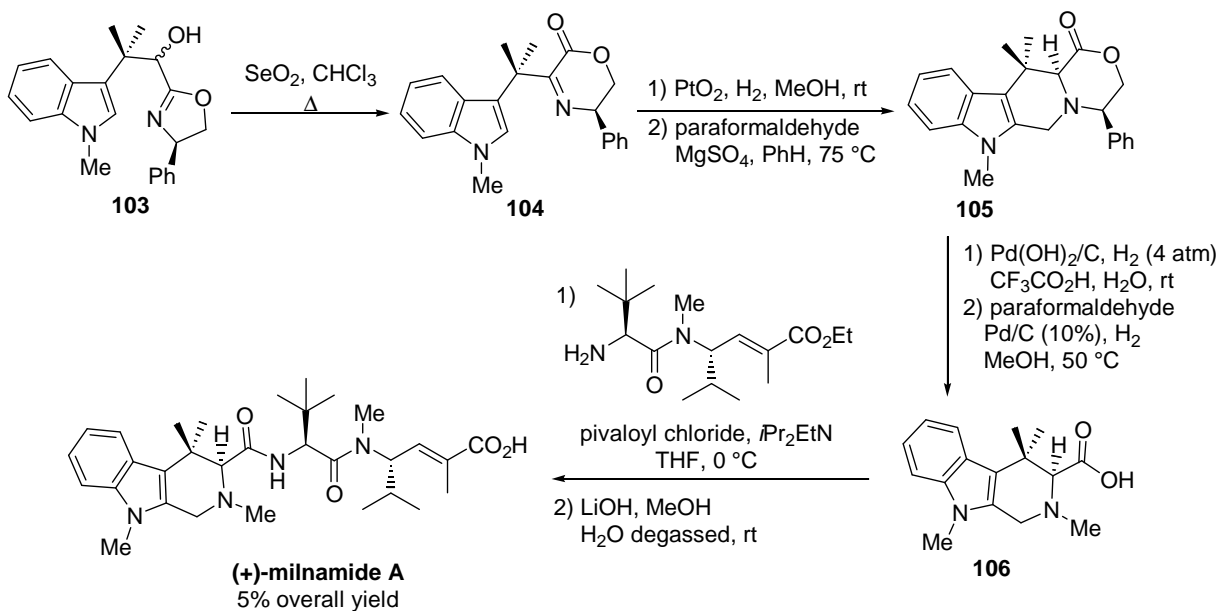

Scheme 78

In a recent total synthesis of (+)-milnamide A, the key feature was the high-yielding preparation of β -carboline amino acid **106**, which is made possible through the facile oxidative rearrangement of oxazoline **103** to the corresponding substituted dihydrooxazinone **104**, which was cyclized into **105** through a reduction-PS reaction sequence (Scheme 78).¹³⁴

Other total syntheses appeared in the last decade are: a biomimetic, enantioselective synthesis of the sarpagine alkaloids (+)-*N*_a-methylvellosimine,¹³⁵ (+)-*N*_a-methylsarpagine, (+)-majvinine and (+)-10-methoxyaffinisine,¹³⁶ and the synthesis of (–)-bengacarboline,¹³⁷ (–)-tangutorine,¹³⁸ (–)-raumacline,¹³⁹ (–)-strychnofoline,¹⁴⁰ chrysocticine,¹⁴¹ eudistomidin-A¹⁴² and arborescidines A, B and C¹⁴³ (Figure 14).

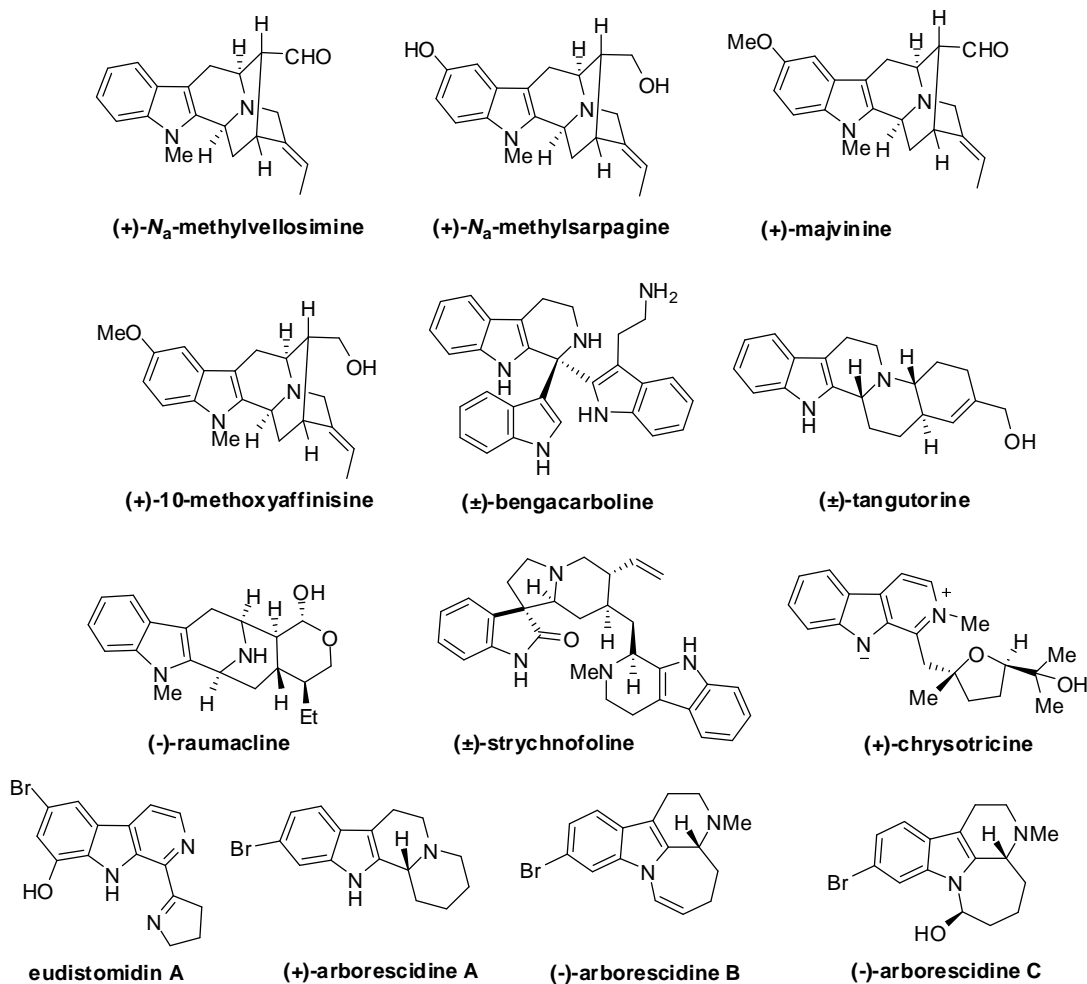

Figure 14

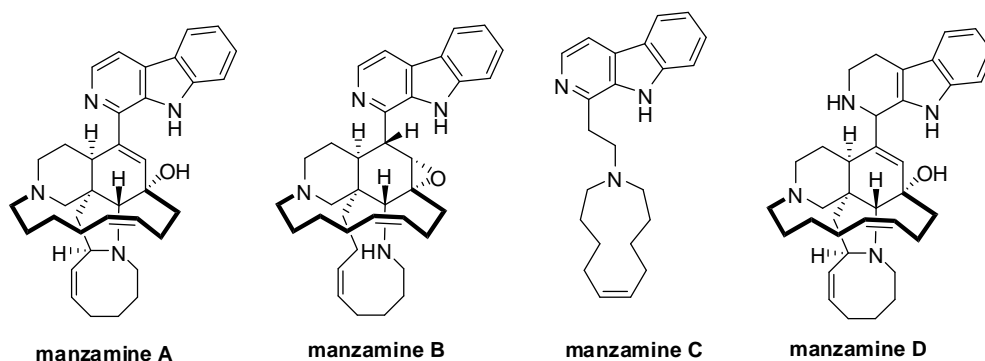

Figure 15

Finally, the synthesis of manzamines (Figure 15 shows representative examples), a marine group of alkaloids, received considerable synthetic attention some years ago.¹⁴⁴

5. Conclusions

Over the years, the tetrahydro- β -carbolines and the β -carboline systems have been found in a widespread of natural products, with intriguing and useful biological activities. In recent times, new compounds are being isolated and characterized and their potential activities being explored, while relatively simple synthetic β -carbolines are found to possess biological activities previously unknown for these structures. These facts explain the great interest in developing efficient synthetic and functionalization strategies for these heterocycles. The traditional PS and BN reactions continue to find use, especially under newly developed reaction conditions, and in catalytic/asymmetric versions. Increasing utility is being found for new methods like those based on organometallic catalysis. The functionalization of the β -carboline system and its use as synthetic intermediate for the synthesis of more complex heterocycles have reached a mature state with the use of various reactions like carbon-carbon coupling, RCM, diverse cycloadditions and stereoselective organocatalytic functionalizations. The most exciting future will deal with catalytic new synthesis of β -carbolines, with focus on tandem reactions, and their application to the total synthesis of natural products. On the other hand, biological evaluation of β -carbolines will continue to give exciting surprises and new drug candidates.

Acknowledgments

Funding of this work by Spanish MEC (No. CTQ2006-00601/BQU), and the Fundación San Pablo CEU is acknowledged. A. G. G. thanks Spanish MEC for a pre-doctoral fellowship.

References

- (a) Hesse, M. In *Alkaloids: Nature's Curse or Blessing*; Verlag Helvetica Chimica Acta; Wiley-VCH, cop: Zurich, 2002. (b) *The Chemistry of Heterocyclic Compounds*; Saxton, J. E., Ed.; Wiley: Chichester, 1994; Part 4, supplement of Vol. 25. (c) Lounasmaa, M.; Hanhinen, P.; Westersund, M. *The Sarpagine Group of Indole Alkaloids In The Alkaloids*; Cordell, G. A., Ed.; Academic Press: San Diego, 1999; Vol. 52. (d) Bi, Y.; Hamaker, L. K.; Cook, J. M. *The Synthesis of Macroline Related Alkaloids In Studies in Natural Products Chemistry, Bioactive Natural Products, Part A*; Basha, F. Z.; Rahman, A., Eds.; Elsevier Science: Amsterdam, 1993; Vol. 13, p. 383. (e) *The Chemistry and Biology of Isoquinoline Alkaloids*; Philipson, J. D.; Roberts, M. F.; Zenk, M. H., Eds.; Springer-Verlag: New York, 1985. (f) *Indole and Biogenetically Related Alkaloids*; Philipson, J. D.; Zenk, M. H., Eds.; Academic Press: London, 1980. (g) *Introduction to Alkaloids: A Biosynthetic Approach*; Cordell, G. A., Ed.; Wiley: New York, 1981. (h) Saxton, J. E. In *The Alkaloids: Chemistry and Biology*; Cordell, G. A., Ed.; Academic Press: San Diego, CA, 1998; Vol. 51, pp. 1–197. (i) Lounasmaa, M.; Tolvanen, A. *Eburnamine-Vincamine Alkaloids In The Alkaloids*; Cordell, G. A., Ed.; Academic Press: San Diego, 1992; Vol. 42.
- (a) Ishida, J.; Wang, H.-K.; Bastow, K. F.; Hu, C.-Q.; Lee, K.-H. *Bioorg. Med. Chem. Lett.* **1999**, *9*, 3319–3324. (b) Ishida, J.; Wang, H. K.; Oyama, M.; Cosentino, M. L.; Hu, C.-Q.; Lee, K. H. *J. Nat. Prod.* **2001**, *64*, 958–960.
- Soriano-Agatón, F.; Lagoutte, D.; Poupon, E.; Roblot, F.; Fournet, A.; Gantier, J. C.; Hocquemiller, R. *J. Nat. Prod.* **2005**, *68*, 1581–1587.
- (a) *Merck Index: an Encyclopedia of Chemicals, Drugs, and Biologicals*, 13th ed.; O'Neil, M. J.; Smith, A.; Heckelman, P. E.; Budavari, S., Eds.; Merck & Co., Inc.: New York, 2001; pp. 1778–1779. (b)

- Kawashima, Y.; Ikemoto, T.; Horiguchi, A.; Hayashi, M.; Matsumoto, K.; Kawarasaki, K.; Yamazaki, R.; Okuyama, S.; Hatayama, K. *J. Med. Chem.* **1993**, 815–819.
5. (a) *The Merck Index*, 11th ed.; *Centennial Edition*; Budavari, S.; O'Neil, M. J.; Smith, A.; Heckelman, P. E.; Eds.; Merck & Co., Inc.: New York, 1989; p. 33. (b) Schemeller, T.; Wink, M. *Utilization of Alkaloids in Modern Medicine In Alkaloids: Biochemistry, Ecology and Medicinal Applications*; Plenum Press: New York, 1998; pp. 435–459.
 6. Hassani, M.; Cai, W.; Koelsch, K. H.; Holley, D. C.; Rose, A. S.; Olang, F.; Lineswala, J. P.; Holloway, W. G.; Gerdes, J. M.; Behforouz, M.; Beall, H. D. *J. Med. Chem.* **2008**, *51*, 3104–3115.
 7. For more references on the synthesis of antitumoral β -carbolines, see: (a) Wu, Q.; Cao, R.; Feng, M.; Guan, X.; Ma, C.; Liu, J.; Song, H.; Peng, W. *Eur. J. Med. Chem.* **2008**, in press. (b) Jenkins, P. R.; Wilson, J.; Emmerson, D.; Garcia, M. D.; Smith, M. R.; Gray, S. J.; Britton, R. G.; Mahale, S.; Chaudhuri, B. *Bioorg. Med. Chem.* **2008**, *16*, 7728–7739. (c) Liu, J.; Cui, G.; Zhao, M.; Cui, C.; Jub, J.; Peng, S. *Bioorg. Med. Chem.* **2007**, *15*, 7773–7788. (d) Zhao, M.; Bi, L.; Wang, W.; Wang, C.; Baudy-Floch, M.; Ju, J.; Peng, S. *Bioorg. Med. Chem.* **2006**, *14*, 6998–7010. (e) Guan, H.; Chen, H.; Peng, W.; Ma, Y.; Cao, R.; Liu, X.; Xu, A. *Eur. J. Med. Chem.* **2006**, *41*, 1167–1179. (f) Shen, Y. C.; Chen, C. Y.; Hsieh, P. W.; Duh, C. Y.; Lin, Y. M.; Ko, C. L. *Chem. Pharm. Bull.* **2005**, *53*, 32–36. (g) Cao, R.; Peng, W.; Chen, H.; Hou, X.; Guan, H.; Chen, Q.; Ma, Y.; Xu, A. *Eur. J. Med. Chem.* **2005**, *40*, 249–257. (h) Cao, R.; Chen, H.; Peng, W.; Ma, Y.; Hou, X.; Guan, H.; Liu, X.; Xu, A. *Eur. J. Med. Chem.* **2005**, *40*, 991–1001. (i) Wang, S.; Dong, Y.; Wang, X.; Hu, X.; Liu, J. O.; Hu, Y. *Org. Biomol. Chem.* **2005**, *3*, 911–916. (j) Cao, R.; Chen, Q.; Hou, X.; Chen, H.; Guan, H.; Ma, Y.; Peng, W.; Xu, A. *Bioorg. Med. Chem.* **2004**, *12*, 4613–4623. (k) Faulkner, D. J.; Newman, D. J.; Cragg, G. M. *Nat. Prod. Rep.* **2004**, *1*, 50–76. (l) Bertrand, M.; Poissonnet, G.; Théret-Bettioli, M.-H.; Gaspard, C.; Werner, G. H.; Pfeiffer, B.; Renard, P.; Léonce, S.; Dodd, R. H. *Bioorg. Med. Chem.* **2001**, *9*, 2155–2164. (m) Deveau, A. M.; Labroli, M. A.; Dieckhaus, C. M.; Barthen, M. T.; Smith, K. S.; Macdonald, T. L. *Bioorg. Med. Chem. Lett.* **2001**, *11*, 1251–1255. (n) García, M. D.; Wilson, A. J.; Emmerson, D. P. G.; Jenkins, P. R.; Mahale, S.; Chaudhuri, B. *Org. Biomol. Chem.* **2006**, *4*, 4478–4484. (o) Kusrkar, R. S.; Goswami, S. K. *Tetrahedron* **2004**, *60*, 5315–5318. (p) Castro, A. C.; Dang, L. C.; Soucy, F.; Grenier, L.; Mazdiyasi, H.; Hottelot, M.; Parent, L.; Pien, C.; Palombella, V.; Adams, J. *Bioorg. Med. Chem. Lett.* **2003**, *13*, 2419–2422. (q) Xiao, S.; Lin, W.; Wang, C.; Yang, M. *Bioorg. Med. Chem. Lett.* **2001**, *11*, 437–441. (r) Wang, H.; Usui, T.; Osada, H.; Ganesan, A. *J. Med. Chem.* **2000**, *43*, 1577–1585. (s) Song, Y.; Wang, J.; Teng, S. F.; Kesuma, D.; Deng, Y.; Duan, J.; Wang, J. H.; Qi, R. Z.; Sim, M. M. *Bioorg. Med. Chem. Lett.* **2002**, *12*, 1129–1132.
 8. Cox, E. D.; Diaz-Arauzo, H.; Huang, Q.; Reddy, M. S.; Ma, C.; Harris, B.; McKernan, R.; Skolnick, P.; Cook, J. M. *J. Med. Chem.* **1998**, *41*, 2537–2552.
 9. Yu, Y.; Lin, W.; Li, J.; Yang, M. *Bioorg. Med. Chem. Lett.* **2004**, *14*, 3127–3130.
 10. Gupta, L.; Srivastava, K.; Singh, S.; Puri, S. K.; Chauhan, P. M. S. *Bioorg. Med. Chem. Lett.* **2008**, *18*, 3306–3309.
 11. For more references on the synthesis of β -carbolines with antimalarial and antiparasite activity, see: (a) Winkler, J. D.; Londregan, A. T.; Ragains, J. R.; Hamann, M. T. *Org. Lett.* **2006**, *8*, 3407–3409. (b) Winkler, J. D.; Londregan, A. T.; Hamann, M. T. *Org. Lett.* **2006**, *8*, 2591–2594. (c) Takasu, K.; Shimogama, T.; Saiin, C.; Kim, H. S.; Wataya, Y.; Ihara, M. *Bioorg. Med. Chem. Lett.* **2004**, *14*, 1689–1692. (d) Kuo, P.-C.; Shi, L.-S.; Damu, A. G.; Su, C.-R.; Huang, C.-H.; Ke, C.-H.; Wu, J.-B.; Lin, A.-J.; Bastow, K. F.; Lee, K.-H.; Wu, T.-S. *J. Nat. Prod.* **2003**, *66*, 1324–1327. (e) Kumar, A.; Katiyar, S. B.; Gupta, S.; Chauhan, P. M. S. *Eur. J. Med. Chem.* **2006**, *41*, 106–113. (f) Costa, E. V.; Pinheiro, M. L. B.; Xavier, C. M.; Silva, J. R. A.; Amaral, A. C. F.; Souza, A. D. L.; Barison, A.; Campos, F. R.; Ferreira, A. G.; Machado, G. M. C.; Leon, L. L. P. *J. Nat. Prod.* **2006**, *69*, 292–294. (g) Srivastava, S. K.; Agarwal, A.; Chauhan, P. M. S.; Agarwal, S. K.; Bhaduri, A. P.; Singh, S. N.; Fatima, N.; Chatterjee, R. K. *J. Med. Chem.* **1999**, *42*, 1667–1672. (h) Fusetani, N. *Nat. Prod. Rep.* **2004**, *21*, 94–104.
 12. Liu, J.; Wu, G.; Cui, G.; Wang, W.-X.; Zhao, M.; Wang, C.; Zhang, Z.; Peng, S. *Bioorg. Med. Chem.* **2007**, *15*, 5672–5693.
 13. Other references on β -carbolines with anti-thrombotic activity: (a) Bi, W.; Cai, J.; Liu, S.; Baudy-Floch, M.; Bi, L. *Bioorg. Med. Chem.* **2007**, *15*, 6909–6919. (b) Zhao, M.; Bi, L.; Bi, W.; Wang, C.;

- Yang, Z.; Jud, J.; Penga, S. *Bioorg. Med. Chem.* **2006**, *14*, 4761–4774. (c) Bi, W.; Bi, L.; Cai, J.; Liu, S.; Peng, S.; Fischer, N. O.; Tok, J. B.-H.; Wang, G. *Bioorg. Med. Chem. Lett.* **2006**, *16*, 4523–4527. (d) Teller, S.; Eluwa, S.; Koller, M.; Uecker, A.; Beckers, T.; Baasner, S.; Böhmer, F.-D.; Mahboobi, S. *Eur. J. Med. Chem.* **2000**, *35*, 413–427.
14. Trujillo, J. I.; Meyers, M. J.; Anderson, D. R.; Hegde, S.; Mahoney, M. W.; Vernier, W. F.; Buchler, I. P.; Wu, K. K.; Yang, S.; Hartmann, S. J.; Reitz, D. B. *Bioorg. Med. Chem. Lett.* **2007**, *17*, 4657–4663.
 15. Gautschi, E.; Goldberg, D. R.; Kashem, M. A.; Lukas, S.; Mao, W.; Martin, L.; Morwick, T.; Moss, N.; Pargellis, C.; Patel, U. R.; Patnaude, L.; Peet, G. W.; Skow, D.; Snow, R. J.; Ward, Y.; Werneburg, B.; White, A. *Bioorg. Med. Chem. Lett.* **2007**, *17*, 4664–4669.
 16. Schott, Y.; Decker, M.; Rommelspacher, H.; Lehmann, J. *Bioorg. Med. Chem. Lett.* **2006**, *16*, 5840–5843.
 17. Ishiyama, H.; Ohshita, K.; Abe, T.; Nakata, H.; Kobayashi, J. *Bioorg. Med. Chem.* **2008**, *16*, 3825–3830.
 18. Di Fabio, R.; Micheli, F.; Alvaro, G.; Cavanni, P.; Donati, D.; Gagliardi, T.; Fontana, G.; Giovannini, R.; Maffei, M.; Mingardi, A.; Tranquillini, M. E.; Vitulli, G. *Bioorg. Med. Chem. Lett.* **2007**, *17*, 2254–2259.
 19. (a) Bahekar, R. H.; Jain, M. R.; Jadav, P. A.; Goel, A.; Patel, D. N.; Prajapati, V. M.; Gupta, A. A.; Modi, H.; Patel, P. R. *Bioorg. Med. Chem.* **2007**, *15*, 5950–5964. For β -carboline based compounds with I₂ inhibition activity, see: (b) Glennon, R. A.; Grella, B.; Tyacke, R. J.; Lau, A.; Westaway, J.; Hudson, A. L. *Bioorg. Med. Chem. Lett.* **2004**, *14*, 527–529. (c) Glennon, R. A.; Grella, B.; Tyacke, R. J.; Lau, A.; Westaway, J.; Hudson, A. L. *Bioorg. Med. Chem. Lett.* **2004**, *14*, 999–1002.
 20. Grella, B.; Teitler, M.; Smith, C.; Herrick-Davis, K.; Glennon, R. A. *Bioorg. Med. Chem. Lett.* **2003**, *13*, 4421–4425.
 21. Bringmann, G.; Feineis, D.; Brückner, B.; Blank, M.; Peters, K.; Peters, E. M.; Reichmann, H.; Janetzky, B.; Grote, C.; Clement, H.-W.; Wesemann, W. *Bioorg. Med. Chem.* **2000**, *8*, 1467–1478.
 22. For reviews containing information on biological activity, isolation and total syntheses of natural β -carboline alkaloids, see (a) Toyota, M.; Ihara, M. *Nat. Prod. Rep.* **1998**, *15*, 327–340. (b) Lounasmaa, M.; Tolvanen, A. *Nat. Prod. Rep.* **2000**, *17*, 175–191. (c) Hibino, S.; Choshi, T. *Nat. Prod. Rep.* **2001**, *18*, 66–87. (d) Hibino, S.; Choshi, T. *Nat. Prod. Rep.* **2002**, *19*, 148–180. (e) Somei, M.; Yamada, F. *Nat. Prod. Rep.* **2003**, *20*, 216–242. (f) Somei, M.; Yamada, F. *Nat. Prod. Rep.* **2004**, *21*, 278–311. (g) Sun, B.; Morikawa, T.; Matsuda, H.; Tewtrakul, S.; Wu, L. J.; Harima, S.; Yoshikawa, M. *J. Nat. Prod.* **2004**, *67*, 1464–1469. (h) Somei, M.; Yamada, F. *Nat. Prod. Rep.* **2005**, *22*, 73–103. (i) Kawasaki, T.; Higuchi, K. *Nat. Prod. Rep.* **2005**, *22*, 761–793. (j) Higuchi, K.; Kawasaki, T. *Nat. Prod. Rep.* **2007**, *24*, 843–868.
 23. Love, B. E. *Org. Prep. Proc. Int.* **1996**, *28*, 1–64.
 24. For reviews, see: (a) Bandini, M.; Emer, E.; Tommasi, S.; Umani-Ronchi, A. *Eur. J. Org. Chem.* **2006**, 3527–3544. (b) Bandini, M.; Melloni, A.; Tommasi, S.; Umani-Ronchi, A. *Synlett* **2005**, 1199–1222.
 25. Pictet, A.; Spengler, T. *Ber. Dtsch. Chem. Ges.* **1911**, *44*, 2030–2036.
 26. Hoover, L. K.; Moo-Young, M.; Legge, R. L. *Biotechnology and Bioengineering* **1991**, *38*, 1029–1033.
 27. Kuo, F.-M.; Tseng, M.-C.; Yen, Y.-H.; Chu, Y.-H. *Tetrahedron* **2004**, *60*, 12075–12084.
 28. Cho, I. S.; Mariano, P. S. *J. Org. Chem.* **1988**, *53*, 1590–1592.
 29. Royer, J.; Bonin, M.; Micouin, L. *Chem. Rev.* **2004**, *104*, 2311–2352.
 30. Seayad, J.; Seayad, A. M.; List, B. *J. Am. Chem. Soc.* **2006**, *128*, 1086–1087.
 31. Youn, S. W. *Org. Prep. Proc. Int.* **2006**, *38*, 505–591.
 32. Other reviews: (a) Cox, E. D.; Cook, J. M. *Chem. Rev.* **1995**, *95*, 1797–1842. (b) Hino, T.; Nakagawa, M. *Heterocycles* **1998**, *49*, 499–530.
 33. (a) Zhuang, W.; Hazell, R. G.; Jørgensen, K. A. *Org. Biomol. Chem.* **2005**, *3*, 2566–2571. For a related approach, see: (b) Bartoli, G.; Di Antonio, G.; Giuli, S.; Marcantoni, E.; Marcolini, M.; Paoletti, M. *Synthesis* **2007**, 320–324.
 34. (a) Kusurkar, R. S.; Alkobati, N. A. H.; Gokule, A. S.; Puranik, V. G. *Tetrahedron* **2008**, *64*, 1654–1662. For more MW assisted PS reactions, see: (b) Liu, F.; You, Q. D. *Synthetic Commun.* **2007**, *37*, 3933–3938. (c) Wu, C.; Sun, C. M. *Synlett* **2002**, 1709–1711.

35. Lingam, Y.; Rao, D. M.; Bhowmik, D. R.; Santu, P. S.; Rao, K. R.; Islam, A. *Tetrahedron Lett.* **2007**, *48*, 7243–7245.
36. Tomasevich, L. L.; Kennedy, N. M.; Zitelli, S. M.; Hull II, R. T.; Gillen, C. R.; Lam, S. K.; Baker, N. J.; Rohanna, J. C.; Conley, J. M.; Guerra, M. L.; Starr, M. L.; Sever, J. B.; Carroll, P. J.; Leonard, M. S. *Tetrahedron Lett.* **2007**, *48*, 599–602.
37. Yang, M. L.; Kuo, P. C.; Damu, A. G.; Chang, R. J.; Chiou, W. F.; Wu, T. S. *Tetrahedron* **2006**, *62*, 10900–10906.
38. Silveira, C. C.; Bernardi, C. R.; Braga, A. L.; Kaufman, T. S. *Org. Lett.* **2005**, *7*, 3701–3704.
39. Mumford, P. M.; Shiers, J. J.; Tarver, G. J.; Hayes, J. F.; Shipman, M. *Tetrahedron Lett.* **2008**, *49*, 3489–3491.
40. Condie, G. C.; Bergman, J. *Eur. J. Org. Chem.* **2004**, 1286–1297, and references cited therein.
41. Pulka, K.; Kulis, P.; Tymecka, D.; Frankiewicz, L.; Wilczek, M.; Kozminski, W.; Misicka, A. *Tetrahedron* **2008**, *64*, 1506–1514.
42. Gomez-Monterrey, I. M.; Campiglia, P.; Bertamino, A.; Aquino, C.; Mazzoni, O.; Diurno, M. V.; Iacovino, R.; Saviano, M.; Sala, M.; Novellino, E.; Grieco, P. *Eur. J. Org. Chem.* **2008**, 1983–1992.
43. Srinivasan, N.; Ganesan, A. *Chem. Commun.* **2003**, 916–917.
44. Taylor, M. S.; Jacobsen, E. N. *J. Am. Chem. Soc.* **2004**, *126*, 10558–10559.
45. Wanner, M. J.; van der Haas, R. N. S.; de Cuba, K.; van Maarseveen, J. H.; Hiemstra, H. *Angew. Chem. Int. Ed.* **2007**, *46*, 7485–7487.
46. Sewgovind, N. V.; Wanner, M. J.; Ingemann, S.; de Gelder, R.; van Maarseveen, J. H.; Hiemstra, H. *J. Org. Chem.* **2008**, *73*, 6405–6408.
47. Mulder, J. A.; Kurtz, K. C. M.; Hsung, R. P. *Synlett* **2003**, 1379–1390.
48. Zhang, Y.; Hsung, R. P.; Zhang, X.; Huang, J.; Slafer, B. W.; Davis, A. *Org. Lett.* **2005**, *7*, 1047–1050.
49. Youn, S. W. *J. Org. Chem.* **2006**, *71*, 2521–2523.
50. Saha, B.; Sharma, S.; Sawant, D.; Kundu, B. *Tetrahedron Lett.* **2007**, *48*, 1379–1383.
51. Reviews: See Ref. 26 and: Nielsen, T. E.; Diness, F.; Meldal, M. *Curr. Opin Drug Discovery Dev.* **2003**, *6*, 801–814.
52. Yeh, W. B.; Lin, M. Y.; Sun, C. M. *Tetrahedron Lett.* **2003**, *44*, 4923–4926.
53. Diness, F.; Beyer, J.; Meldal, M. *Chem. Eur. J.* **2006**, *12*, 8056–8066.
54. Danieli, B.; Giovanelli, P.; Lesma, G.; Passarella, D.; Sacchetti, A.; Silvani, A. *J. Comb. Chem.* **2005**, *7*, 458–462.
55. Nielsen, T. E.; Meldal, M. *J. Org. Chem.* **2004**, *69*, 3765–3773, and references cited therein.
56. Lee, S. C.; Choi, S. Y.; Chung, Y. K.; Park, S. B. *Tetrahedron Lett.* **2006**, *47*, 6843–6847.
57. Yeh, W. P.; Chang, W. J.; Sun, M. L.; Sun, C. M. *Tetrahedron* **2007**, *63*, 11809–11816.
58. Dardennes, E.; Kovács-Kulyassa, A.; Boisbrun, M.; Petermann, C.; Laronze, J. Y.; Sapi, J. *Tetrahedron: Asymmetry* **2005**, *16*, 1329–1339.
59. Karpov, A. S.; Rominger, F.; Müller, T. J. J. *Org. Biomol. Chem.* **2005**, *3*, 4382–4391.
60. Luo, S.; Zhao, J.; Zhai, H. *J. Org. Chem.* **2004**, *69*, 4548–4550.
61. Flick, A. C.; Padwa, A. *Tetrahedron Lett.* **2008**, *49*, 5739–5741.
62. (a) Bischler, A.; Napieralski, B. *Chem. Ber.* **1893**, *26*, 1891–1903. (b) Movassaghi, M.; Hill, M. D. *Org. Lett.* **2008**, *10*, 3485–3488.
63. Chakrabarti, S.; Panda, K.; Ila, H.; Junjappa, H. *Synlett* **2005**, 309–313.
64. Spaggiari, A.; Davoli, P.; Balszczak, L. C.; Prati, F. *Synlett* **2005**, 661–663.
65. Lee, C. S.; Liu, C. K.; Chiang, Y. L.; Cheng, Y. Y. *Tetrahedron Lett.* **2008**, *49*, 481–484.
66. Takasu, K.; Nishida, N.; Tomimura, A.; Ihara, M. *J. Org. Chem.* **2005**, *70*, 3957–3962.
67. Malamidou-Xenikaki, E.; Vlachou, C.; Stampelos, X. N. *Tetrahedron* **2006**, *62*, 9931–9941.
68. Ishida, A.; Nakamura, T.; Irie, K.; Oh-ishi, T. *Chem. Pharm. Bull.* **1985**, *33*, 3237–3249.
69. Arazny, Z.; Czarnocki, Z.; Wojtasiewicz, K.; Maurin, J. K. *Tetrahedron: Asymmetry* **2000**, *11*, 2793–2800.
70. Szawkalo, J.; Czarnocki, S. J.; Zawadzka, A.; Wojtasiewicz, K.; Leniewski, A.; Maurin, J. K.; Czarnocki, Z.; Drabowicz, J. *Tetrahedron: Asymmetry* **2007**, *18*, 406–413.
71. Pal, B.; Jaisankar, P.; Giri, V. S.; Mondal, S.; Mukherjee, M. *Tetrahedron Lett.* **2004**, *45*, 6489–6492.

72. (a) Zhang, H.; Larock, R. C. *J. Org. Chem.* **2002**, *67*, 7048–7056. (b) Zhang, H.; Larock, R. C. *Tetrahedron Lett.* **2002**, *43*, 1359–1362. For a related approach, see: (c) Abbiati, G.; Beccalli, E. M.; Marchesini, A.; Rossi, E. *Synthesis* **2001**, 2477–2483.
73. (a) Zhang, H.; Larock, R. C. *J. Org. Chem.* **2002**, *67*, 9318–9330. (b) Zhang, H.; Larock, R. C. *Org. Lett.* **2001**, *3*, 3083–3086.
74. Liu, C.; Widenhoefer, R. A. *J. Am. Chem. Soc.* **2004**, *126*, 10250–10251.
75. Beccalli, E. M.; Broggin, G.; Marchesini, A.; Rossi, E. *Tetrahedron* **2002**, *58*, 6673–6678.
76. Abbiati, G.; Beccalli, E. M.; Broggin, G.; Zoni, C. *J. Org. Chem.* **2003**, *68*, 7625–7628.
77. Kuethe, J. T.; Wong, A.; Davies, I. W.; Reider, P. J. *Tetrahedron Lett.* **2002**, *43*, 3871–3874.
78. Agnusdei, M.; Bandini, M.; Melloni, A.; Umani-Ronchi, A. *J. Org. Chem.* **2003**, *68*, 7126–7129.
79. Angeli, M.; Bandini, M.; Garelli, A.; Piccinelli, F.; Tommasi, S.; Umani-Ronchi, A. *Org. Biomol. Chem.* **2006**, *4*, 3291–3296.
80. (a) Bandini, M.; Melloni, A.; Umani-Ronchi, A. *Org. Lett.* **2004**, *6*, 3199–3202. (b) Bandini, M.; Meloni, F.; Piccinelli, F.; Sinisi, R.; Tommasi, S.; Umani-Ronchi, A. *J. Am. Chem. Soc.* **2006**, *128*, 1424–1425.
81. England, D. B.; Padwa, A. *Org. Lett.* **2008**, *10*, 3631–3634.
82. Rocca, P.; Marsais, F.; Godard, A.; Queguiner, G.; Adams, L.; Aio, B. *Tetrahedron Lett.* **1995**, *16*, 7085–7088.
83. Boger, D. L.; Duff, S. R.; Panek, J. S.; Yasuda, M. *J. Org. Chem.* **1985**, *50*, 5782–5789.
84. Dantale, S. W.; Söderberg, B. C. G. *Tetrahedron* **2003**, *59*, 5507–5514.
85. Wagner, F. F.; Comins, D. L. *Org. Lett.* **2006**, *8*, 3549–3552.
86. Chen, L. C.; Yang, S. C.; Wang, H. M. *Synthesis* **1995**, 385–386.
87. Engler, T. A.; Wanner, J. *J. Org. Chem.* **2000**, *65*, 2444–2457.
88. Suzuki, H.; Tsukakoshi, Y.; Tachikawa, T.; Miura, Y.; Adachi, M.; Murakami, Y. *Tetrahedron Lett.* **2005**, *46*, 3831–3834.
89. Bondzic, B. P.; Eilbracht, P. *Org. Lett.* **2008**, *10*, 3433–3436.
90. (a) Fan, W.-H.; Parkh, M.; Snyder, J. K. *Tetrahedron Lett.* **1995**, *36*, 6591–6594. (b) Fan, W.-H.; Snyder, J. K. *Tetrahedron Lett.* **1998**, *39*, 2487–2490.
91. Benson, S. C.; Li, J.-H.; Snyder, J. K. *J. Org. Chem.* **1992**, *57*, 5285–5287.
92. Lindsley, C. W.; Wisnoski, D. D.; Wang, Y.; Leister, W. H.; Zhao, Z. *Tetrahedron Lett.* **2003**, *44*, 4495–4498.
93. (a) Achab, S.; Diker, K.; Potier, P. *Tetrahedron Lett.* **2001**, *42*, 8825–8828. See also for related examples: (b) Ivanov, I.; Nikolova, S.; Statkova-Abeghe, S. *Heterocycles* **2005**, *65*, 2483–2492.
94. Hudlicky, T.; Rinner, U.; Finn, K. J.; Ghiviriga, I. *J. Org. Chem.* **2005**, *70*, 3490–3499.
95. (a) Suzuki, H.; Iwata, C.; Sakurai, K.; Tokumoto, K.; Takahashi, H.; Hanada, M.; Yokoyama, Y.; Murakami, Y. *Tetrahedron* **1997**, *53*, 1593–1606. (b) Suzuki, H.; Adachi, M.; Ebihara, Y.; Gyoutoku, H.; Furuya, H.; Murakami, Y.; Okuno, H. *Synthesis* **2005**, 28–32.
96. (a) Molina, P.; Fresneda, P. M.; Garcia-Zafra, S. *Tetrahedron Lett.* **1996**, *37*, 9353–9356. (b) Molina, P.; Fresneda, P. M.; Garcia-Zafra, S. *Tetrahedron Lett.* **1995**, *36*, 3581–3582.
97. (a) Kusurkar, R.; Goswami, S. K.; Vyas, S. M. *Tetrahedron Lett.* **2003**, *44*, 4761–4763. See also: (b) Kanekiyo, N.; Choshi, T.; Kuwada, T.; Sugino, E.; Hibino, E. S. *Heterocycles* **2000**, *53*, 1877–1880.
98. Kinderman, S. S.; Wekking, M. M. T.; van Maarseveen, J. H.; Schoemaker, H. E.; Hiemstra, H.; Rutjes, F. P. J. T. *J. Org. Chem.* **2005**, *70*, 5519–5527.
99. Duval, E.; Cuny, G. D. *Tetrahedron Lett.* **2004**, *45*, 5411–5413.
100. See for example: Iwadate, M.; Yamashita, T.; Tokuyama, H.; Fukuyama, T. *Heterocycles* **2005**, *66*, 241–248.
101. (a) Batch, A.; Dodd, R. H. *J. Org. Chem.* **1998**, *63*, 872–877. (b) Batch, A.; Dodd, R. H. *Heterocycles* **1999**, *50*, 875–885.
102. Busacca, C. A.; Eriksson, M. C.; Dong, Y.; Prokopowicz, A. S.; Salvagno, A. M.; Tschantz, M. A. *J. Org. Chem.* **1999**, *64*, 4564–4568.
103. Poissonnet, G.; Théret-Bettiol, M. H.; Dodd, R. H. *J. Org. Chem.* **1996**, *61*, 2273–2282.
104. Nyerges, M.; Viranyi, A.; Toth, J.; Blasko, G.; Toke, L. *Synthesis* **2006**, 1273–1278.
105. Moriyama, S.; Vallée, Y. *Synthesis* **1998**, 393–404.

106. Moriyama, S.; Vallée, Y. *Eur. J. Org. Chem.* **1998**, 1391–1395.
107. Grigg, R.; MacLachlan, W. S.; MacPherson, D. T.; Sridharan, V.; Suganthan, S.; Thornton-Pett, M.; Zhang, J. *Tetrahedron* **2000**, *56*, 6585–6594.
108. Sawant, D.; Kumar, R.; Maulik, P. R.; Kundu, B. *Org. Lett.* **2006**, *8*, 1525–1528.
109. Saha, B.; Kumar, B.; Maulik, P. R.; Kundu, B. *Tetrahedron Lett.* **2006**, *47*, 2765–2769.
110. Winterfeldt, E. *Liebigs Ann. Chem.* **1971**, *745*, 23–30.
111. Jiang, W.; Zhang, X.; Sui, Z. *Org. Lett.* **2003**, *5*, 43–46.
112. Tietze, L. F.; Zhou, Y.; Töpken, E. *Eur. J. Org. Chem.* **2000**, 2247–2252.
113. Uematsu, N.; Fujii, A.; Hashiguchi, S.; Ikariya, T.; Noyori, R. *J. Am. Chem. Soc.* **1996**, *118*, 4916–4917.
114. (a) Santos, L. S.; Pilli, R. A.; Rawal, V. H. *J. Org. Chem.* **2004**, *69*, 1283–1289. (b) Roszkowski, P.; Wojtasiewicz, K.; Leniewski, A.; Maurin, J. M.; Lis, T.; Czarnocki, Z. *J. Mol. Catal. A* **2005**, *232*, 143–149. (c) Wu, J.; Wang, F.; Ma, Y.; Ciu, X.; Cun, L.; Zhu, J.; Deng, J.; Yu, B. *Chem. Commun.* **2006**, 1766–1768.
115. Morimoto, T.; Suzuki, N.; Achiwa, K. *Heterocycles* **2004**, *63*, 2097–2100.
116. Enthaler, S.; Erre, G.; Junge, K.; Addis, D.; Kadyrov, R.; Beller, B. *Chem. Asian J.* **2008**, *3*, 1104–1110.
117. Santos, L. S.; Fernandes, S. A.; Pilli, L. A.; Marsaioli, A. J. *Tetrahedron: Asymmetry* **2003**, *13*, 2515–2519.
118. Polniaszek, R. P.; Bell, S. J. *Tetrahedron Lett.* **1996**, *37*, 575–578.
119. (a) Adam, S.; Pannecoucke, X.; Combret, J. C.; Quirion, J. C. *J. Org. Chem.* **2001**, *66*, 8744–8750. For other similar approaches with different chiral auxiliaries, see: (b) Weber, U.; Hoest, C.; Ponikwar, W.; Suter, M.; Noth, H.; Wanner, K. T. *Heterocycles* **2004**, *63*, 2747–2766.
120. Itoh, T.; Enomoto, Y.; Ohsawa, A. *Tetrahedron* **2001**, *57*, 7277–7289.
121. (a) Itoh, T.; Miyazaki, M.; Ikeda, S.; Nagata, K.; Yokoya, M.; Matsuya, Y.; Enomoto, Y.; Ohsawa, A. *Tetrahedron* **2003**, *59*, 3527–3536. (b) Itoh, T.; Nagata, K.; Yokoya, M.; Miyazaki, M.; Ikeda, S.; Matsuya, Y.; Enomoto, Y.; Ohsawa, A. *Synlett* **2002**, 1005–1007.
122. (a) Itoh, T.; Miyazaki, M.; Nagata, K.; Nakamura, S.; Ohsawa, A. *Heterocycles* **2004**, *63*, 655–661. (b) Itoh, T.; Miyazaki, M.; Nagata, K.; Yokoya, M.; Nakamura, S.; Ohsawa, A. *Heterocycles* **2002**, *58*, 115–118.
123. (a) Itoh, T.; Yokoya, M.; Miyauchi, K.; Nagata, K.; Ohsawa, A. *Org. Lett.* **2003**, *5*, 4301–4304. (b) Itoh, T.; Yokoya, M.; Miyauchi, K.; Nagata, K.; Ohsawa, A. *Org. Lett.* **2006**, *8*, 1533–1535.
124. Evans, P.; Grigg, R.; York, M. *Tetrahedron Lett.* **2000**, *41*, 3967–3970.
125. Neipp, C. E.; Martin, S. F. *J. Org. Chem.* **2003**, *68*, 8867–8878.
126. Gonzalez-Gomez, A.; Dominguez, G.; Perez-Castells, J. *Tetrahedron Lett.* **2005**, *46*, 7267–7270.
127. Henin, J.; Vereauteren, J.; Manganot, C.; Henin, B.; Nuzillard, J. M.; Gullhem, J. *Tetrahedron* **1999**, *55*, 9817–9828.
128. (a) Carotti, A.; de Candia, M.; Catto, M.; Borisova, T. N.; Varlamov, A. V.; Mendez-Alvarez, E.; Soto-Otero, R.; Voskressensky, L. G.; Altomare, C. *Bioorg. Med. Chem.* **2006**, *14*, 7205–7212. See also: (b) Voskressensky, L. G.; Borisova, T. N.; Kulikova, L. N.; Varlamov, A. V.; Catto, M.; Altomare, C.; Carotti, A. *Eur. J. Org. Chem.* **2004**, 3128–3135. (c) Voskressensky, L. G.; Borisova, T. N.; Kostenev, I. S.; Vorobiev, I. V.; Varlamov, A. V. *Tetrahedron Lett.* **2005**, *46*, 1975–1979.
129. Gonzalez-Gomez, A.; Dominguez, G.; Amador, U.; Perez-Castells, J. *Tetrahedron Lett.* **2008**, *49*, 5467–5470.
130. Zhu, H. J.; Xiang, J. X.; Saebo, S.; Pittman, C. U., Jr. *J. Org. Chem.* **2005**, *70*, 261–267.
131. England, D. B.; Padwa, A. *J. Org. Chem.* **2008**, *73*, 2792–2802.
132. Ohba, M.; Natsutani, I.; Sakuma, T. *Tetrahedron* **2007**, *63*, 10337–10344.
133. Deiters, A.; Pettersson, M.; Martin, S. F. *J. Org. Chem.* **2006**, *71*, 6547–6561.
134. Liu, C.; Masuno, M. N.; MacMillan, J. B.; Molinski, T. Z. *Angew. Chem. Int. Ed.* **2004**, *43*, 5951–5954.
135. Deiters, A.; Chen, K.; Eary, C. T.; Martin, S. F. *J. Am. Chem. Soc.* **2003**, *125*, 4541–4550.
136. Zhao, S.; Liao, X.; Wang, T.; Flippen-Anderson, J.; Cook, J. M. *J. Org. Chem.* **2003**, *68*, 6279–6295.

137. Peng, J.; Hu, J.-F.; Kazi, A. B.; Li, Z.; Avery, M.; Peraud, O.; Hill, R. T.; Franzblau, S. G.; Pouilhés, F. A.; Langlois, Y.; Chiaroni, A. *Synlett* **2003**, 1488–1490.
138. (a) Putkonen, T.; Tolvanen, A.; Jokela, R.; Caccamese, S.; Parrinello, N. *Tetrahedron* **2003**, *59*, 8589–8595. (b) Zifcicsak, L. C. A.; Hsung, R. P. *Org. Lett.* **2003**, *5*, 4709–4712.
139. Bailey, P. D.; Clingan, P. D.; Mills, T. J.; Price, R. A.; Pritchard, R. G. *Chem. Commun.* **2003**, 2800–2801.
140. Lerchner, A.; Carreira, E. M. *J. Am. Chem. Soc.* **2002**, *124*, 14826–14827.
141. Zhang, J.-X.; Wang, G.-X.; Xie, P.; Chen, S.-F.; Liang, X.-T. *Tetrahedron Lett.* **2000**, *41*, 2211–2213.
142. Murakami, Y.; Watanabe, T.; Takahashi, H.; Yokoo, H.; Nakazawa, Y.; Koshimizu, M.; Adachi, N.; Kurita, M.; Yoshino, T.; Inagaki, T.; Ohishi, M.; Watanabe, M.; Tani, M.; Yokoyama, Y. *Tetrahedron* **1998**, *54*, 45–64.
143. Burm, B. E. A.; Meijler, M. M.; Korver, J.; Wanner, M. J.; Koomen, G. J. *Tetrahedron* **1998**, *54*, 6135–6146. For an enantioselective total syntheses of (+)-arborescidines A-C, see Ref. 111a.
144. (a) Humphrey, J. M.; Liao, Y.; Ali, A.; Rein, T.; Wong, Y.-L.; Chen, H.-J.; Courtney, A. K.; Martin, S. F. *J. Am. Chem. Soc.* **2002**, *124*, 8584–8592. (b) Martin, S. F.; Humphrey, J. M.; Ali, A.; Hillier, M. C. *J. Am. Chem. Soc.* **1999**, *121*, 866–867. (c) Jakubowicz, K.; Abdeljelil, K. B.; Herdemann, M.; Martin, M.-T.; Gateau-Olesker, A.; Mourabit, A. A.; Marazano, C.; Das, B. C. *J. Org. Chem.* **1999**, *64*, 7381–7387. (d) Magnier, E.; Langlois, Y. *Tetrahedron* **1998**, *54*, 6201–6258. (e) Baldwin, J. E.; Claridge, T. D. W.; Culshaw, A. J.; Heupel, F. A.; Lee, V.; Spring, D. R.; Whitehead, R. C.; Boughtflower, R. J.; Mutton, I. M.; Upton, R. J. *Angew. Chem. Int. Ed.* **1998**, *37*, 2661–2663. (f) Winkler, J. D.; Axten, J. M. *J. Am. Chem. Soc.* **1998**, *120*, 6425–6426. (g) Brands, K. M. J.; Di Michele, L. M. *Tetrahedron Lett.* **1998**, *39*, 1677–1680. (h) Magnier, E.; Langlois, Y. *Tetrahedron Lett.* **1998**, *39*, 837–840. (i) Li, S.; Yamamura, S. *Tetrahedron* **1998**, *54*, 8691–8710. (j) Li, S.; Yamamura, S. *Tetrahedron Lett.* **1998**, *39*, 2597–2600. (k) Li, S.; Yamamura, S.; Hosomi, H.; Ohba, S. *Tetrahedron Lett.* **1998**, *39*, 2601–2604. (l) Vidal, T.; Magnier, E.; Langlois, Y. *Tetrahedron* **1998**, *54*, 5959–5966. (m) Winkler, J. D.; Axten, J.; Hammach, A. H.; Kwak, Y.-S.; Lengweiler, U.; Lucero M. J.; Houk, K. N. *Tetrahedron* **1998**, *54*, 7045–7056.

MESO-SUBSTITUTED PORPHYRIN SYNTHESIS FROM MONOPYRROLE: AN OVERVIEW

Mariette M. Pereira,* Carlos J. P. Monteiro and Andreia F. Peixoto

*Departamento de Química, Universidade de Coimbra, Rua Larga, P-3004-535 Coimbra, Portugal
(e-mail: mmpereira@qui.uc.pt)*

Abstract. *In this paper, methods available for the synthesis of meso-substituted porphyrins will be reviewed. Nowadays, most of the meso-substituted porphyrins are synthesized according to one of two methodologies: condensation reaction of pyrrole with the corresponding aldehyde followed by cyclization to the porphyrinogen and subsequent oxidation to the corresponding porphyrin in just one pot; or condensation-cyclization reaction of pyrrole with the corresponding aldehyde in one step, followed by the oxidation of the porphyrinogen to the corresponding porphyrin using different oxidizing agents, in a separated step. Clearly, the production of sustainable products contributes to economic profit for innovative enterprises and thereby affords an opportunity for competitive advantage compared to production and marketing in old-fashioned concepts. Some new approaches of meso-substituted porphyrin synthesis using more sustainable chemical processes, avoiding the use of chlorinated solvents and/or the use of inorganic acids as catalysts, is also described. In this review we will focus on the landmark methods until 2000 and in more detail the papers between 2001–2008.*

Contents

1. Introduction
2. *Meso*-substituted porphyrin synthesis
 - 2.1. One-pot synthesis
 - 2.2. Two-step synthesis
3. *Meso*-tetraarylporphyrin synthesis using sustainable chemistry approach
 - 3.1. Solvent-free reactions
 - 3.2. Microwave synthesis
 - 3.3. Ionic liquids
 - 3.4. Heterogeneous catalysis: zeolites and clays

Acknowledgments

References

Abbreviations

1. Introduction

Porphyrin chemistry has grown significantly in the last two decades, owing to its multiple applications in several fields, including new materials,¹ solar energy conversion,² medicine³ and catalysis.⁴

This review does not intend to be an extensive compilation of all the papers so far published, because it has been widely covered in books^{5,6} and several recent reviews^{7–9} on the development of *meso*-porphyrin synthesis.

Since Lindsey¹⁰ has provided an excellent review in “The Porphyrin Handbook” (2000), this paper will focus primarily on examples published since then.

Metalloporphyrins and derivatives perform an enormous diversity of functions in live systems. They are the essential pigments in the transportation of oxygen by hemoglobin in the oxidative degradation of drugs, by cytochrome enzyme P-450, and in the photosynthetic processes, by green plants.¹¹

There are two accepted nomenclature systems for porphyrins. Hans Fischer¹² proposed a simple numbering system where the β -pyrrolic positions are numbered from 1–8 and the $\alpha, \beta, \gamma, \delta$ positions are called *meso* positions (Scheme 1A). The Fischer nomenclature system leaves several carbon atoms unassigned in more complicated structures, so, IUPAC has subsequently adopted another system¹³ which involves the serial numbering of all carbon atoms (Scheme 1B). Since many steps are involved in the synthesis of the majority of natural porphyrins, the most useful compounds for large scale applications are the artificial ones with substituents in the *meso* positions and, in most cases, with β -positions free (Scheme 1A).

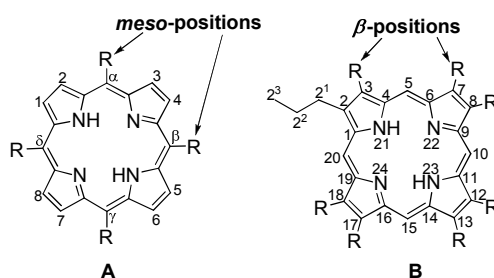

Scheme 1

So, there is an increased interest in the development of *meso*-substituted porphyrin synthesis. They can be used as ligands of metal ions, as biomimetic catalysis,^{14–17} in the photodegradation of pollutants^{18,19} and also for therapeutic purposes.^{20–23}

Advancing knowledge of the so-called Rothmund^{24,25} reaction to broaden its applicability as an efficient preparative method is still a challenge. The principal attraction of finding a synthetic solution to building the *meso*-tetrapyrrolic macrocycles is the fact that the necessary raw materials are the inexpensive pyrrole and an aldehyde. Through a sequence of condensation reactions, these compounds would cyclize to give the porphyrinogen that can be oxidize into the respective porphyrin. The various easy and cheaper synthetic methodologies for *meso*-substituted porphyrins, so far developed, have opened the way for their large scale synthesis and potential industrial application.

This paper presents a comparative review of the different synthetic strategies used for the synthesis of *meso*-substituted porphyrin derived from monopyrrole.

2. *Meso*-substituted porphyrin synthesis

2.1. One-pot synthesis

In a pioneering work, Rothmund²⁴ (1935) described the preparation of symmetric porphyrins by simple condensation of pyrrole with the appropriate aldehyde dissolved in pyridine/methanol, under anaerobic conditions, heated at 100 °C in a sealed tube. According to the author, these conditions allowed him to obtain 25 new porphyrins with different substituents in the *meso* positions (Scheme 2A). This strategy became a landmark in *meso*-porphyrin synthesis but not to the degree that its author initially expected,

because the yields were always very low, except with benzaldehyde. Rothmund quickly realized that only the condensation reaction of pyrrole with this aldehyde yields satisfactory and reproducible results (10% yield).²⁶ However, in this work the author reports finding 10–20% of an unidentified isomeric porphyrinic contaminant. Later on, in the *meso*-tetrakisphenylporphyrin (TPP) synthesis, Calvin showed, for the first time, that the contaminant was not the isomeric porphyrin, claimed by Rothmund, but the corresponding reduced product, chlorin.^{27,28} He observed that the amount of chlorin is not only strongly dependent on the temperature but also on the presence of metal salts. He also observed that, when the condensation of pyrrole with benzaldehyde is carried out in the presence of zinc acetate using pyridine as solvent, better TPP yield is obtained without chlorin contamination. In this work, Calvin also gave a remarkable contribution for the quantification of the amount of chlorin in a mixture of porphyrin/chlorin using the UV-visible spectra of the zinc porphyrin and zinc chlorin metal complexes.²⁹ Adler's contribution^{30–32} to the definitive establishment of the Rothmund reaction as a potential synthetic method should be emphasized. He observed,³¹ for the first time, that the yields are considerably better when the reaction occurs in acidic medium. Mixing equimolar amounts of pyrrole and benzaldehyde in propionic acid and heating it to the reflux temperature, the TPP directly precipitates with yields of ~20%, despite being contaminated with about 10% of the corresponding chlorin (Scheme 2B).

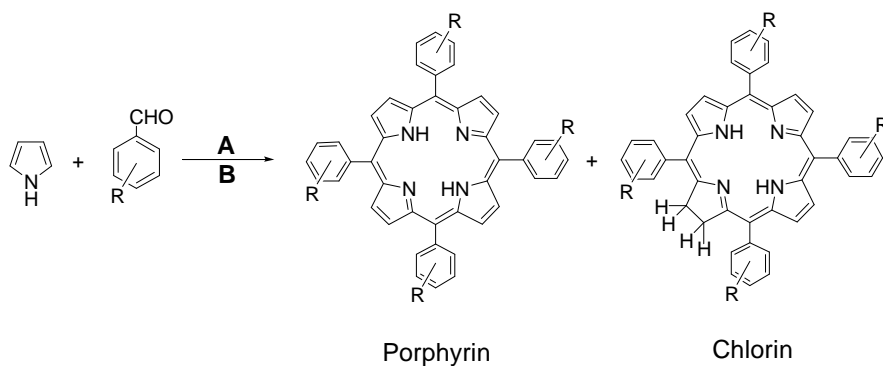





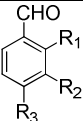

- A. Rothmund's reaction conditions: pyridine/methanol; 115 °C; sealed tube.
 B. Adler's reaction conditions: propionic acid; 130 °C; air.

Scheme 2

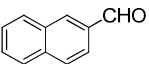
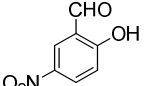
Meanwhile, despite this work by Adler being the fundamental contribution for obtaining a true TPP synthetic method, he did not arrive at the universal solution for *meso*-tetrasubstituted porphyrin synthesis. Using the conditions he described, it was still impossible to obtain porphyrins in reasonable yields through the pyrrole condensation reaction with a large number of aldehydes, *viz.*, alkyl and *ortho*-substituted arylaldehydes. The methods of chlorin oxidation to the corresponding porphyrins were slow and an expensive reflux with DDQ (2,3-dichloro-5,6-dicyanobenzoquinone) or chloranil (2,3,5,6-tetrachloro-1,4-benzoquinone) taking several hours, are required.^{33,34} Despite that, Adler's methodology paved the way for the synthesis of a large number of porphyrins, as can be seen by the original paper having more than 1500 citations and being well reviewed by Lindsey.¹⁰ Table 1 gives selected examples of aldehydes that have been condensed with pyrrole to yield the corresponding *meso*-tetraarylporphyrin *via* Adler's synthetic methodology, published since 2000.

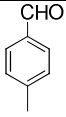
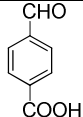
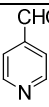
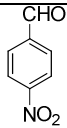
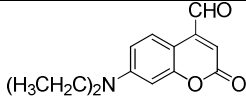
Table 1. Selected examples of *meso*-tetraarylporphyrin synthesis using Adler's methodology.

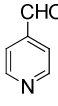
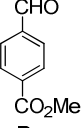
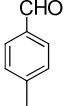
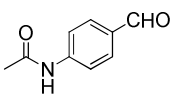
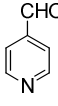
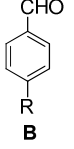
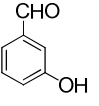
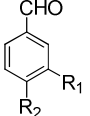
Aldehyde		Yield (%)	Reference
 $R_1=Me, R_2=R_3=H$ $R_2=Me, R_1=R_3=H$ $R_3=Me, R_1=R_2=H$		20–25	35
 			
		72	36
		6	37
		9.3	
 a) A	 B	5	38
 a) A	 B	4–8	39,40
 a) A	 B	b)	41
 a) A	 B	25	42
 a) A	 B	3	43
 a) A	 B $R_1=OH$ $R_2=OMe$ $R_3=CO_2CH_2CH_3$ $R_4=CO_2H$	b)	44,45
 a) A	 B $R_1=H, R_2=OMe$ $R_1=OMe, R_2=H$	b)	46

a) Condensation of pyrrole with the appropriate mixture of aldehydes A+B.

b) Yields are not available.

It is well established that the appropriate substituents of *meso*-tetraarylporphyrins, for catalytic studies, are bulky groups on the *o*-positions of the phenyl ring to avoid μ -oxo or μ -peroxo dimer formation on oxygenation.⁴⁷ In order to attain new oxidation catalysts, different authors set out to develop the synthesis of *meso*-tetramesitylporphyrin (TMP), *meso*-tetra(2,6-dichlorophenyl)porphyrin (TDCPP) and *meso*-tetra(2,6-dimethoxyphenyl)porphyrin (TDOMePP) (Scheme 3).

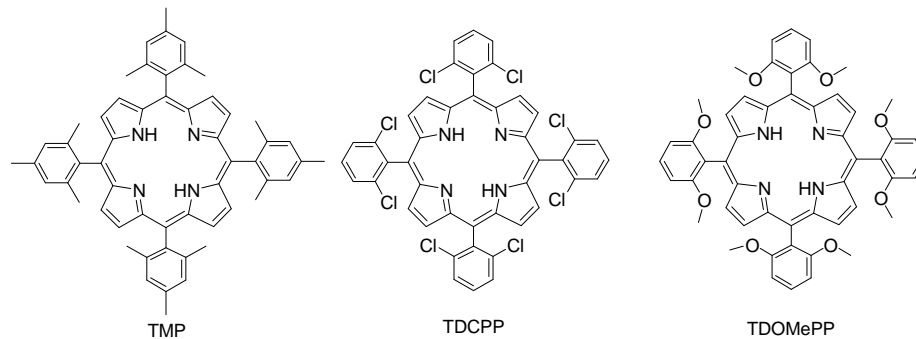

Scheme 3

Badger⁴⁸ made the first attempt to prepare TMP by modifying the Rothmund procedure using pyridine, mesitaldehyde and pyrrole in the presence of zinc(II) acetate, as template. Only 1% of TMP was obtained and it was always contaminated with a large amount of the corresponding chlorin. Other modifications have been tried by Traylor⁴⁹ and Meunier,⁵⁰ replacing pyridine by 2,4,6-collidine in the presence of air (temperature of the reaction was 170 °C) and using anhydrous zinc acetate. With these methods it was possible to obtain a 5.8% yield of TMP. Hill^{51,52} did a similar adaptation for the synthesis of TDCPP. In the modified method, 2,4,6-collidine was the solvent and the pyrrole condensation reaction with 2,6-dichlorobenzaldehyde took place in the presence of zinc acetate at 160 °C over 3 hours. The authors report achieving a maximum of 3.7% porphyrin yield concomitantly with the preferential formation of *meso*-[(2,6-dichlorophenyl)-5,5'-bis(dichlorobenzyl)]-dipyrromethene (Scheme 4).

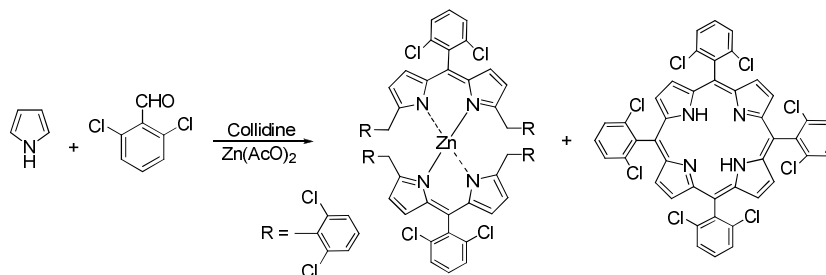

Scheme 4



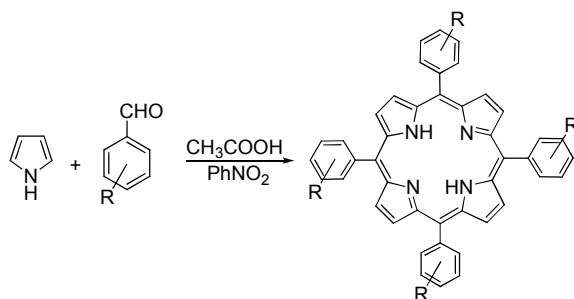

Attempts in the Coimbra laboratory to obtain TDCPP through this method never led to the isolation of any porphyrin. The problem of TDCPP synthesis thus could not be solved satisfactorily in a reproducible way, to obtain the necessary amounts of porphyrin to carry out catalytic studies. The Coimbra group^{53a,b} observed a beneficial influence of the presence of nitrated solvents, namely the nitrobenzene, in the one-pot Rothmund reaction. The experiment of making the pyrrole react with 2,6-dichlorobenzaldehyde in acetic acid/nitrobenzene (7:3) at a temperature of 120 °C leads to the formation of porphyrin, that crystallizes directly from the reaction medium during cooling or after methanol addition, giving 5% of pure TDCPP (Scheme 5).

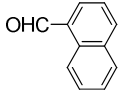
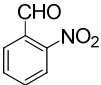
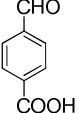

Scheme 5

Table 2. Selected examples of *meso*-tetra substituted porphyrins synthesis using the nitrobenzene synthetic method.

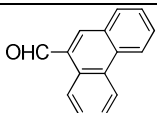
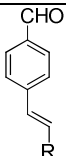
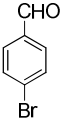
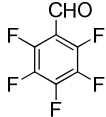
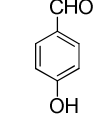
Aldehyde	Yield (%)	References	
	20	54,55	
	R ₁ =NO ₂ , R ₂ =R ₃ =H R ₂ =NO ₂ , R ₁ =R ₃ =H R ₃ =NO ₂ , R ₁ =R ₂ =H	20 9 25	54
	46	55	
	R ₁ =R ₃ =R ₄ =H, R ₂ =OMe R ₁ =R ₂ =OMe, R ₃ =R ₄ =H R ₁ =R ₂ =R ₃ =H, R ₄ =OMe	78 18 45	54,55
	27	55	
	R ₁ =R ₂ =R ₄ =H, R ₃ =Cl R ₁ =R ₃ =Cl, R ₂ =R ₄ =H R ₂ =R ₃ =H, R ₁ =R ₄ =Cl R ₁ =R ₃ =R ₄ =H, R ₂ =Cl	56 9 5 22	54,55
	37	55	
	9	55	
	13	55	
	12	55	
	R ₁ =OCH ₂ CO ₂ Et, R ₂ =R ₃ =H R ₁ =R ₃ =H, R ₂ =OCH ₂ CO ₂ Et R ₁ =R ₂ =H, R ₃ =OCH ₂ CO ₂ Et R ₁ =H, R ₂ =R ₃ =OCH ₂ CO ₂ Et R ₁ =H, R ₂ =OMe, R ₃ =OCH ₂ CO ₂ Et	a) 	56

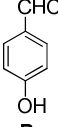
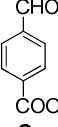
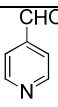
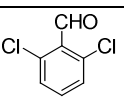
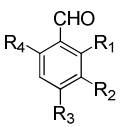
	10 23	54 57
<div style="display: flex; justify-content: space-around;"> <div style="text-align: center;">  A </div> <div style="text-align: center;">  B </div> </div>	5	58
	40	59
	26	60
<div style="display: flex; align-items: center;"> <div style="text-align: center;">  R = COOBu, C₆H₅OMe </div> <td style="text-align: center; vertical-align: middle;">7</td> <td style="text-align: center; vertical-align: middle;">61</td> </div>	7	61
	25	
	8	62
	15	63
<div style="display: flex; justify-content: space-around;"> <div style="text-align: center;">  A </div> <div style="text-align: center;">  B </div> <div style="text-align: center;">  C </div> </div>	7–13	63
<div style="display: flex; justify-content: space-around;"> <div style="text-align: center;">  A </div> <div style="text-align: center;">  B </div> </div>	a)	64
<div style="display: flex; align-items: center;"> <div style="text-align: center;">  </div> <td style="text-align: center; vertical-align: middle;">a)</td> <td style="text-align: center; vertical-align: middle;">65–67</td> </div>	a)	65–67

^{a)}Yields are not available.

^{b)}Condensation of pyrrole with the appropriate mixture of aldehydes A+B.

^{c)}Condensation of pyrrole with the appropriate mixture of aldehydes A+B+C.

Given the favourable influence of the presence of nitrobenzene in the formation of the TDCPP, this new method was extended to the synthesis of other porphyrins.^{54,55} Using this synthetic strategy, the porphyrins generally crystallize directly from the reaction medium in pure form, without any contamination with the corresponding chlorins. Nitrobenzene/air at 120 °C are efficient oxidants to promote the direct

transformation of the porphyrinogen to the corresponding porphyrins. Evidence of an electron transfer mechanism involving nitrobenzene, both as solvent and oxidizing agent in aromatization reactions, with concomitant reduction to *N*-hydroxyaniline and aniline is well documented.⁵³ Simplex optimization was employed in order to achieve the best reaction conditions (valeric acid/nitrobenzene: 2.3/1; temperature: 160 °C) and *meso*-tetra(4-methoxyphenyl)porphyrin was obtained with 78% yield without any chlorin contamination. These advantages make the nitrobenzene synthetic method a really alternative to the previously described methodology for *meso*-porphyrin synthesis. Selected examples of *meso*-substituted porphyrins using this synthetic approach are listed in Table 2.

The synthesis of the *meso*-tetra(4-nitrophenyl)porphyrin with 22% of yield and of the *meso*-tetra(4-carboxyphenyl)porphyrin with 32% of yield are good examples to show the potential of this method to solve the problem of inaccessible porphyrin synthesis under the conditions previously described in literature.^{69,70} The main advantages of the acetic acid/nitrobenzene method over the Adler conditions are the easy crystallisation of the porphyrins directly from the reaction medium and the total absence of chlorins in the final products. At higher temperatures nitrobenzene is not only a good inductor of crystallization of the porphyrins but also a good oxidant of the intermediates, porphyrinogen and/or chlorin to the corresponding porphyrins.

2.2. Two-step *meso*-substituted porphyrin synthesis

Despite the good synthetic approach obtained using one-pot Adler's methodology, the synthesis of both, the *meso*-tetraalkylporphyrin and porphyrins with bulky substituents on the *ortho*-positions of the phenyl ring, was still a complicated synthetic problem until 1985. By that time, Gonsalves and Pereira⁷¹ had described a new synthetic strategy for the *meso*-tetraalkylporphyrin synthesis. The method consists of separating the condensation-cyclization step of pyrrole with aldehydes or acetals [using carbon tetrachloride as solvent and catalytic amounts of trifluoroacetic acid (TFA) under inert atmosphere] from the oxidation step of the porphyrinogen into the corresponding porphyrins, using a stoichiometric amount of quinones (Scheme 6A) or even by photochemical methods (Scheme 6B).

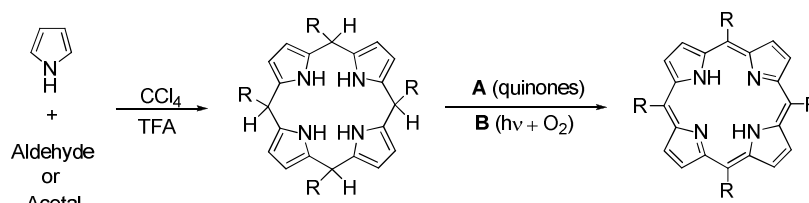

Scheme 6

Later on, the two-step synthetic methodology was extended by Drenth⁷² and Lindsey^{73–75} to the *meso*-tetraarylporphyrin synthesis. In this method, the condensation of pyrrole with the desired arylaldehydes is carried out in mild reaction conditions using chlorinated solvents (CHCl₃ or CH₂Cl₂), with strong acids as catalysts, using high dilutions under inert atmosphere. The use of a Lewis acid, as catalyst, allowed a significant improvement in the synthesis of porphyrins with bulky substituents in the *ortho* positions, attaining yields of 30% of TDCPP. This porphyrin is impossible to synthesize by Adler's method³¹ and yields of 5% were obtained with the nitrobenzene approach.⁵⁴ The *meso*-arylporphyrinogens are oxidized into the corresponding porphyrins using high potential quinones, chloranil or DDQ, in a separately

step, as for *meso*-tetraalkylporphyrins. The Lindsey's method is now a strong landmark in *meso*-substituted porphyrin synthesis due to the quite good yields, so far achieved, and also because the final products do not show any contamination with the corresponding chlorins. The huge number of applications of *meso*-tetraarylporphyrins is a good reason for the high number of recent papers centred on the optimization of reaction conditions, to improve the overall yield of the two-step porphyrin synthesis, as well as to understand the reaction mechanism. It is well established that the two-step approach requires the optimization of two major aspects: i) the condensation of pyrrole with the aldehydes and preferential cyclization to the porphyrinogen stage and ii) oxidation of the porphyrinogen to the corresponding porphyrins. In the condensation of pyrrole with benzaldehyde, it was demonstrated by several authors^{41,76-88} and in particular by the extensive work of Lindsey,^{73-75,89,90} that the condensation process is very sensitive to the concentration and nature of the reagents, acid catalyst^{74,91,92} and also co-catalysts, such as ethanol^{77,93} or salts.^{94,95} Yields of TPP in the range of 5% up to 58% were obtained by selective modulation of these parameters and BF₃-Et₂O (1 mM) with NaCl (25 mM) and a solution of pyrrole (10 mM) and aldehyde (10 mM), using CH₂Cl₂ as solvent, are the best reaction conditions so far obtained for TPP synthesis.⁹² However, it should be emphasized that these are not general conditions and the optimized reactions are strongly dependent on the aldehyde and catalyst used.⁹⁶

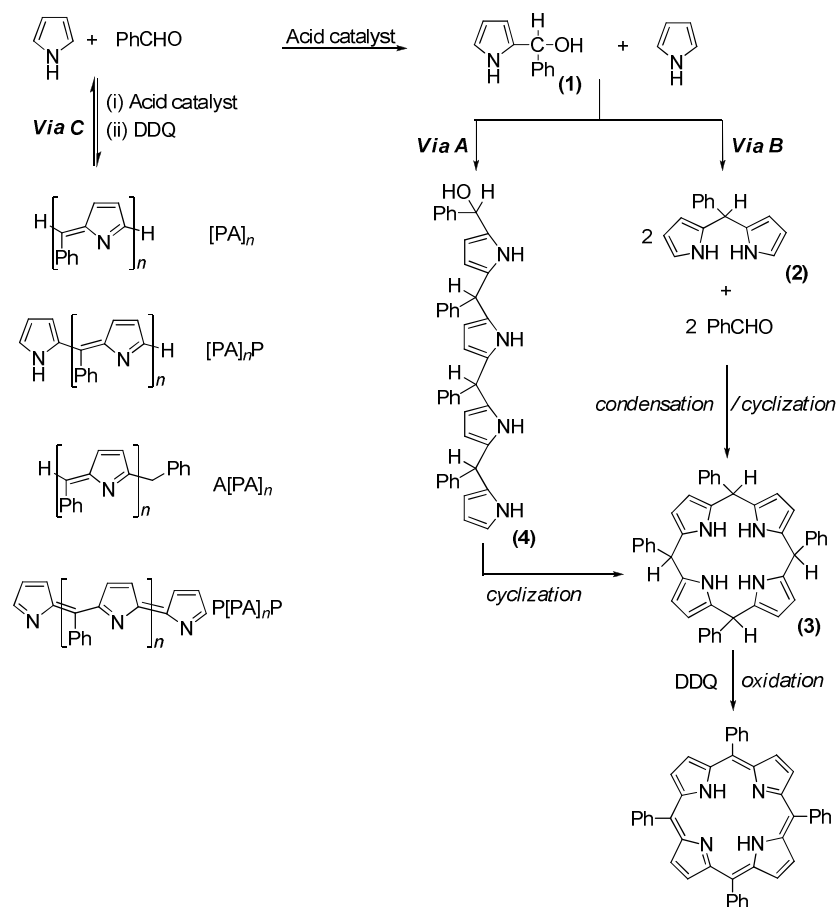

Scheme 7

Several mechanistic studies have been carried out involving the chromatographic separation and characterization of the side products^{97,98} but, difficulties in the final interpretation of the results make almost



all of them inconclusive. It still has not been well established if the first step involves the condensation of pyrrole with benzaldehyde to give pyrrolylcarbynol (**1**) and phenyldipyrromethane (**2**), followed by cyclization into the corresponding porphyrinogen (**3**), or if it preferentially involves the autocondensation of pyrrolylcarbynol (**1**) to form the linear tetrapyrrolic (**4**) species, followed by cyclization into the desired porphyrinogen (**3**).

From Lindsey's studies of TPP synthesis, evidence has been found for the formation of α -substituted tetrapyrrole oligomers that, on cyclization, yields the porphyrinogen (**3**) (*Via A*, Scheme 7) or alternatively it can pursue by condensation of pyrrole with pyrrolylcarbynol unit to form phenyldipyrromethane (**2**) (*Via B*, Scheme 7). The oligomers are indubitably critical intermediates in the formation of porphyrinogens and they can amount to 50% or more of the side products derived from the starting materials (*Via C*, Scheme 7). In a recent extensive study Lindsey⁹⁷ employed laser desorption mass spectrometry (LD-MS) to complement other analytical methods for the characterization of oligomers. They observed the main oligomer peaks in a range of m/z 155–1900 and organized them in four series, based on the termini chain groups: i) a pyrrole terminus and an aldehyde terminus, $[PA]_n$; ii) pyrrole units at both termini, $[PA]_nP$; iii) aldehyde units at both termini, $A[PA]_n$; iv) pyrrole groups at both termini series and internal 2,2'-bipyrrole group, $P[PA]_nP$. This study allowed the conclusion that the maximum yield of TPP and of oligomers is obtained concomitantly and in similar reaction times. With longer reaction times, the yield of porphyrins, and also of large oligomers, diminishes. This may be due to the reversibility of some steps of the polymerization process. Lindsey⁹⁸ also analysed the direct condensation of phenyldipyrromethane with benzaldehyde, by LD-MS and obtained similar results to those obtained from the direct condensation of pyrrole with benzaldehyde, after 1 hour. However, in earlier reaction times longer oligomers were observed, suggesting that they can undergo cleavage during the reaction period.

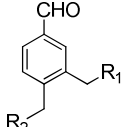
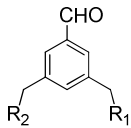
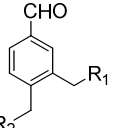
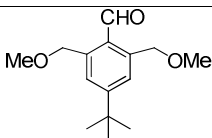
Table 3. Selected examples of *meso*-tetraarylporphyrin synthesis using Lindsey's methodology.

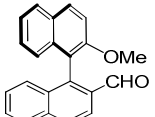
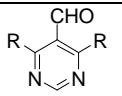
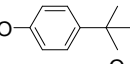
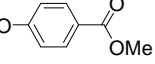
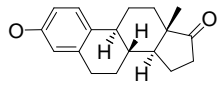
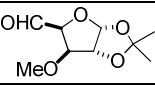
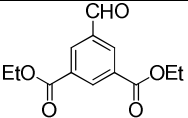
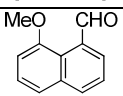
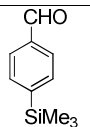
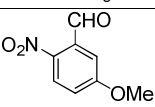
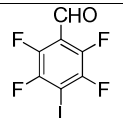
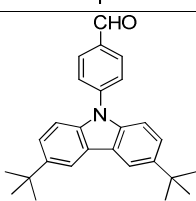
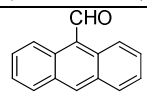
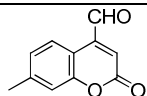
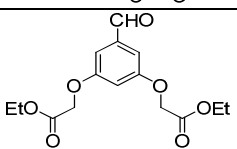
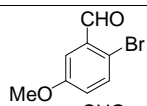
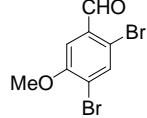
Aldehyde	Yield (%)	Reference
	33 32	
$R_1 = 2\text{-methyl-}o\text{-carborane}; R_2 = \text{H}$ $R_1 = \text{H}; R_2 = 2\text{-methyl-}o\text{-carborane}$		
	15	76
$R_1 = R_2 = 2\text{-methyl-}o\text{-carborane}$		
	34 33	
$R_1 = o\text{-carborane}; R_2 = \text{H}$ $R_1 = \text{H}; R_2 = o\text{-carborane}$		
	7	77

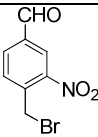
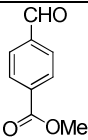
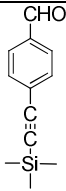
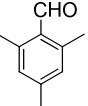
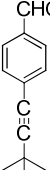
	10	78
 R =   	30–54	79
	6	80
	25	81
	32	82
	48	83
	20	84
	17	85
	30	86
	3	87
	5.3	41
	41	88
	22	99
	18	

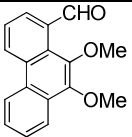
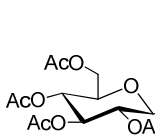
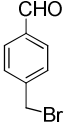
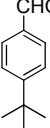
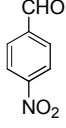
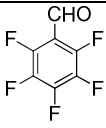
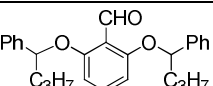
a)			10.5	100
a)			10	101
a)			11	102
a)			22	103
a)			31	104
a)			11	105
a)			18	106

^{a)}Condensation of pyrrole with the appropriate mixture of aldehydes A+B.

On the other hand, *in situ* NMR studies of the condensation of pyrrole with alkylaldehydes undertaken by Gonsalves and Pereira⁷¹ (CCl₄ as solvent and TFA as catalyst) showed the exclusive formation of dipyrromethane and porphyrinogen. From all these studies it is important to notice that despite the large number of papers so far published the optimization of *meso*-tetraarylporphyrin synthesis is still a challenge and a matter of great interest in the porphyrin scientific community.

Since an extensive review of the *meso*-tetraarylporphyrin synthesis was published by Lindsey¹⁰ in 2000, we give here a set of selected examples obtained by Lindsey's synthetic methodology, published in the period 2000–2008 (Table 3).

The major drawback of this method, for the potential large scale application, is the use of very expensive quinones as oxidizing agents, very high dilutions, in the first step, and the elaborate and costly purification procedures needed to isolate the porphyrin.

The use of hydrogen peroxide, for the oxidation of the porphyrinogen into the corresponding porphyrins, is an interesting alternative for replacing the expensive quinones (Scheme 8).⁵⁵ Recently, Serra¹⁰⁷ extended this method to the synthesis of brominated and iodinated derivatives of *meso*-tetraarylporphyrins bearing hydroxyl groups (Scheme 8).

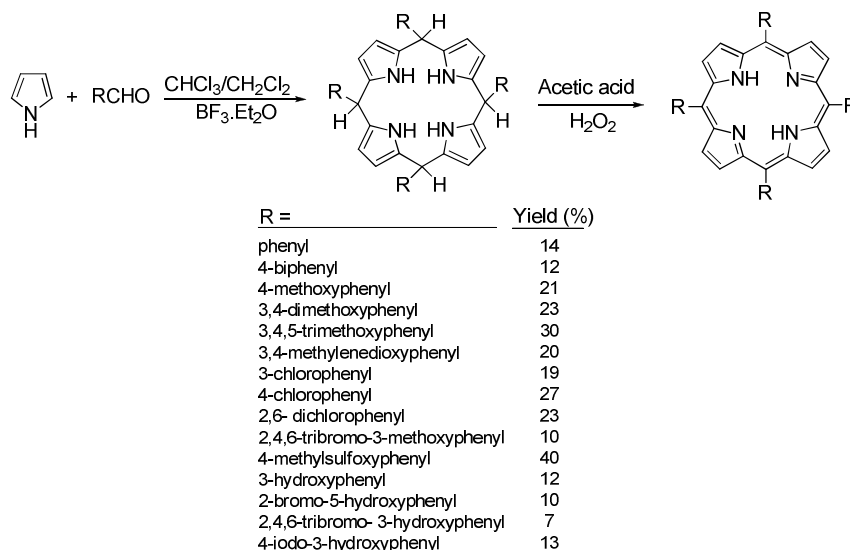

Scheme 8

Sharghi further developed the system to combine the mild reaction conditions of Lindsey's method with the air oxidation of Adler's methodology. This method allows the preparation of a large number of *meso*-tetraarylporphyrins, using PCl_5 ¹⁰⁸ or $\text{CF}_3\text{SO}_2\text{Cl}$ ¹⁰⁹ as catalyst and air as oxidant, at room temperature. These catalysts gave excellent activities to promote the condensation/cyclization reaction of pyrrole and aromatic aldehydes. The use of air, as oxidant, instead of high potential quinones allowed the synthesis of *meso*-tetraarylporphyrins bearing sensitive functional groups in the phenyl ring. The reported reaction conditions afford *meso*-tetraarylporphyrins in 20–65% yields. The authors observed that the condensation of the monomers, as well as the cyclization of the tetrapyrrolic oligomers, using $\text{CF}_3\text{SO}_2\text{Cl}$ as catalyst, are irreversible reactions and claim that the main advantages of this method are the reasonable porphyrin yields with easy work-up and the use of air as oxidant.

Lu¹¹⁰ described the synthesis of *meso*-tetra(oligocarbazole)porphyrins using xylene as solvent and *p*-nitrobenzoic acid as catalyst for the condensation-cyclization reaction of pyrrole with the aldehyde of interest. The oxidation of the porphyrinogen to the corresponding porphyrins was carried out by air with 18–26% of yield.

3. *Meso*-tetraarylporphyrin synthesis using sustainable chemistry approaches

The multitude of porphyrin applications, in the last few years, has transformed the interest of these compounds from purely academic to industrial processes. There is an increasing demand for development of new synthetic processes involving sustainable chemistry principles avoiding dangerous solvents, reactants

and excessive energy consumption. It is very relevant to implement new, more selective and efficient synthetic methods with low environmental impact. In this section, we will address some new strategies to synthesize *meso*-porphyrins using alternative reaction media and catalysts.

3.1. Solvent-free reactions

A clean and efficient one step synthesis of *meso*-tetraarylporphyrins was described by Drain¹¹¹ using pyrrole and aryl aldehydes in gas phase reaction, without the use of any organic solvent or catalyst.¹¹² The pyrrole is slowly added into the reaction vessel where the aldehyde was submitted to temperatures 10–15 °C above its boiling point. After 2 or 3 seconds a brown-purple vapor is formed and the porphyrins precipitate concomitantly with black tars. A wide variety of *meso*-substituted porphyrins have been synthesized by this method without contamination with chlorins, with yields ranging from 7 to 23%. The oxidation of the porphyrinogen into the corresponding porphyrin was made by air, since no porphyrin was obtained when the reaction was carried out under inert atmosphere. The use of one-pot porphyrin synthesis, in a solvent-free gas phase reaction, was also described by Krausz¹¹³ using charcoal, treated with nitric acid, as solid acid catalyst for the condensation of pyrrole with arylaldehydes (Scheme 9). The main limitation of these solvent-free synthetic methods is the low stability of pyrrole at the high temperatures required, along with the high energy consumption.

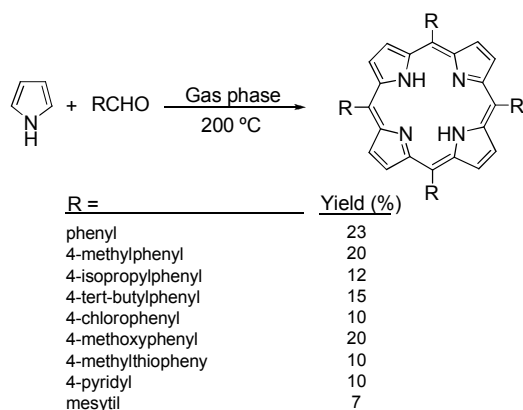

Scheme 9

3.2. Microwave synthesis

Microwave-assisted processes have been recently used as a fast and clean tools for organic synthesis.¹¹⁴ The one-pot condensation of pyrrole with arylaldehydes using a very low quantity of propionic acid (modification of Adler's method) followed by microwave irradiation in a very short time period (10–15 min.) gave reasonable yields for a wide range of *meso*-tetraarylporphyrins.^{115–118} This microwave-assisted synthesis was also applied to obtain *meso*-tetraarylporphyrin *via* the nitrobenzene method.¹¹⁹ When equimolar amounts of pyrrole and arylaldehydes were dissolved in a very small amount of propionic acid/nitrobenzene followed by microwave irradiation (5 min.), the desired porphyrins were formed in good yields, without any contamination with chlorins (Scheme 10). These authors also described the efficient preparation of metalloporphyrins with very small amounts of organic solvents.

A new microwave-assisted method using iodine as catalyst was proposed by Krausz and co-workers¹²⁰ for *meso*-tetraphenylporphyrin synthesis. The two-step approach was optimized and the best reaction

conditions were equimolar amounts of pyrrole and benzaldehyde at 30 °C and 100W of microwave activation, yielding 47% of TPP, after 21 minutes (Scheme 11).

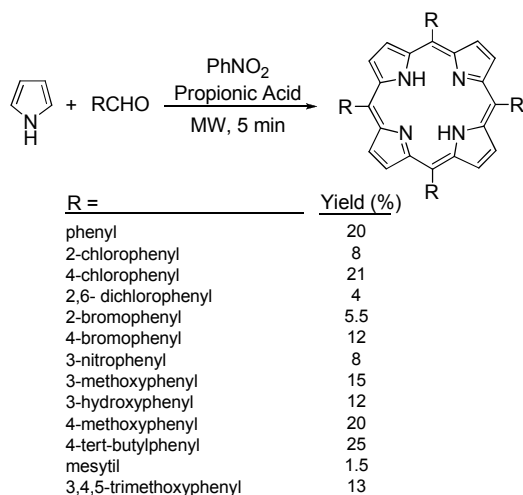

Scheme 10

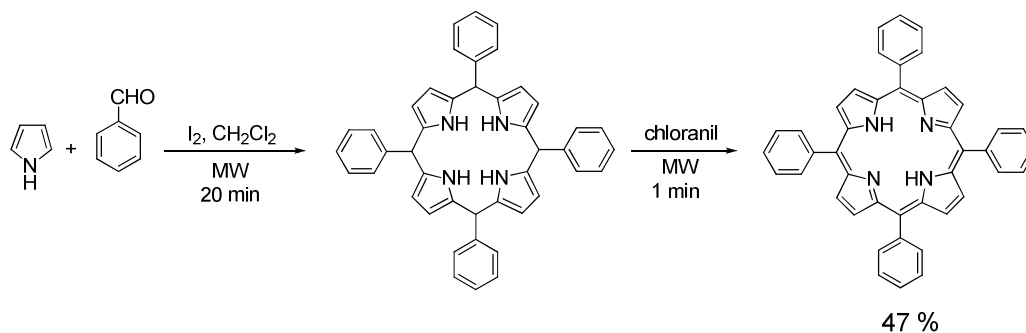

Scheme 11

The microwave synthetic strategy presents three main advantages relative to previously described methods: i) it can be done in high concentration of pyrrole and aldehydes; ii) the contamination with the corresponding chlorins was almost zero; iii) reduction of energy consumption is attained due to the lower reaction times used.

3.3. Ionic liquids

Ionic liquids have been widely used as alternative solvents for promoting several organic reactions.¹²¹ The two-step approach for porphyrin synthesis still present some critical aspects that need considerable attention, in particular the use of large amounts of chlorinated solvents and the use of toxic acids, as catalysts. Recently, Ishikawa^{122,123} proposed the use of an acidic ionic liquid to catalyze the condensation of pyrrole with benzaldehyde. The use of 3-butyl-1-(butyl-4-sulfonyl) imidazolium trifluoroethanesulfonate as solvent and catalyst, with dichloromethane as second immiscible phase, followed by oxidation of the porphyrinogen with DDQ, allowed the synthesis of *meso*-tetraarylporphyrins in similar yields to those previously obtained by Lindsey's method. By this methodology, the authors also observed the formation of the corresponding *N*-confused porphyrin. The acidic ionic liquid was reusable ten times, without loss of activity (Scheme 12).

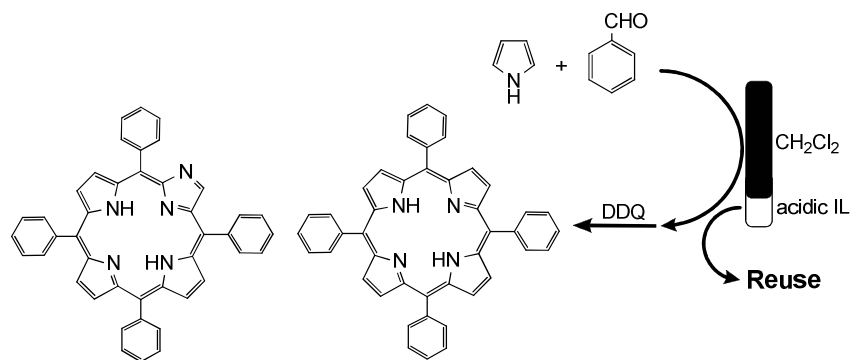

Scheme 12

It should be emphasized that the synthesis of porphyrins using ionic liquids as solvents without dichloromethane was not possible due to the formation of black tars that did not allow the subsequent reutilization of the ionic liquid.

3.4. Heterogeneous catalysts: zeolites and clays

It has been indicated that minerals were the potential catalysts for porphyrins biogenesis from pyrroles and aldehydes in prebiotic era.¹²⁴ As previously referred, the disadvantage of two-step porphyrin synthesis is the use of expensive and toxic acid catalysts. Their substitution by reusable inorganic acidic solids is an important goal.^{125–129} Onaka¹²⁸ observed that the mesoporous acid FSM-16 is an efficient catalyst to promote the condensation of pyrrole with aromatic aldehydes using dichloromethane as solvent (Table 4).

Table 4. *meso*-Tetraarylporphyrin synthesis in the presence of zeolites.

Aldehyde	Yield (%)	References
	23.5 ^a ; 28 ^b	125
	56.5 ^a ; 50.4 ^b	126
	38 ^c	128
	31 ^c	128
	40.1 ^a	125
	37 ^c	128
	41 ^c	128
	16 ^a	125
	3 ^c	126
	7 ^c	

a) Al-MCM-41; b) HZSM-5; c) FSM-16 (2.8 nm).

More recently, zeolites such as HZSM-5 and MCM-41 have been used as catalysts for solvent free porphyrin synthesis.^{125–127} HZSM-5 and MCM-41 have been also used as TLC plates and support for

condensation of pyrrole with aldehyde under microwave irradiation.¹²⁶ After microwave irradiation during 12 min., the plate was developed using chloroform/methanol as eluent. This is an alternative method that allows the porphyrin synthesis and purification in just one step (Table 4).

Acidic clays have also been used as efficient and reusable catalysts, to catalyze the condensation of pyrrole with aldehydes according to the previously described methods.^{128,130–133} After oxidation with chloranil, the porphyrin yields, using zeolites and clays, are very similar to those obtained by Lindsey⁸⁹ with BF₃OEt₂ as catalyst.

Acknowledgments

CCDRC (Programa Operacional da Região Centro, Medida 1.5), Bluepharma Indústria Farmacêutica S.A., FEDER and FCT (PTDC/QUI/66015/2006) for financial support. C. J. P. Monteiro thanks FCT for the PhD grant (SFRH/BD/37652/2007) and A. F. Peixoto thanks FCT for the PhD grant (SFRH/BD/29681/2006).

References

1. Dini, D.; Yang, G. Y.; Hanack, M. In *Targets in Heterocyclic Systems, Chemistry and Properties*; Attanasi, O. A.; Spinelli, D., Eds.; Società Chimica Italiana: Rome, 2004; Vol. 8, pp. 1–32.
2. Campbell, W. M.; Burrell, A. K.; Officer, D. L.; Jolley, K. W. *Coord. Chem. Rev.* **2004**, *248*, 1363.
3. *The Fundamental Bases of Phototherapy*; Honidsmann, H.; Jori, G.; Young, A. R., Eds.; OEMF Spa: Milano, 1996.
4. Wijesekera, T. P.; Dolphin, D. In *Metalloporphyrins in Catalytic Oxidations*; Sheldon, R. A., Ed.; Marcel Dekker: New York, 1994; pp. 193–231.
5. *Porphyrins and Metalloporphyrins*; Smith, K. M., Ed.; Elsevier Scientific Publishing Company: Amsterdam, 1975.
6. Kim, J. B.; Adler, A. D.; Longo, F. R. In *The Porphyrins*; Dolphin, D., Ed.; Academic Press, Inc.: New York, 1978, Vol. 1, pp 88–95.
7. Shanmugathan, S.; Edwards, C.; Boyle, R. W. *Tetrahedron* **2000**, *56*, 1025.
8. Syrbu, S. A.; Ageeva, T. A.; Semeikin, A. S.; Koifman, O. I. *Russ. Chem. Bull.* **2007**, *56*, 707.
9. Vicente, M. G. H.; Smith, K. M. *Curr. Org. Chem.* **2000**, *4*, 139.
10. Lindsey, J. S. In *The Porphyrin Handbook*; Kadish, K. M.; Smith, K. M.; Guillard, R., Eds.; Academic Press: San Diego, 2000; Vol. 1.
11. *The Colours of Life: An Introduction to the Chemistry of Porphyrins and Related Compounds*; Milgrom, L. R., Ed.; Oxford University Press: Oxford, 1997.
12. Fischer, H.; Orth, H. In *Die Chemie des Pyrrols*; Akad. Verlagsgesellschaft: Leipzig, 1934; Vol. 1.
13. Moss, G. P. *Pure Appl. Chem.* **1987**, *59*, 779.
14. Gonsalves, A. M. D. R.; Pereira, M. M. *J. Mol. Cat. A: Chem.* **1996**, *113*, 209.
15. Rebelo, S. L. H.; Pereira, M. M.; Simões, M. M. Q.; Neves, M. G. P. M. S.; Cavaleiro, J. A. S. *J. Catal.* **2005**, *234*, 76.
16. Groves, J. T. *J. Inorg. Biochem.* **2006**, *100*, 434.
17. Rebelo, S. L. H.; Gonçalves, A. R.; Pereira, M. M.; Simões, M. M. Q.; Neves, M. G. P. M. S.; Cavaleiro, J. A. S. *J. Mol. Cat. A: Chem.* **2006**, *256*, 321.
18. Monteiro, C. J. P.; Pereira, M. M.; Azenha, M. E.; Burrows, H. D.; Serpa, C.; Arnaut, L. G.; Tapia, M. J.; Sarakha, M.; Wong-Wah-Chung, P.; Navaratnam, S. *Photochem. Photobiol. Sci.* **2005**, *4*, 617.
19. Rebelo, S. L. H.; Melo, A.; Coimbra, R.; Azenha, M. E.; Pereira, M. M.; Burrows, H. D.; Sarakha, M. *Environ. Chem. Lett.* **2007**, *5*, 29.
20. Dabrowski, J. M.; Pereira, M. M.; Arnaut, L. G.; Monteiro, C. J. P.; Peixoto, A. F.; Karocki, A.; Urbanska, K.; Stochel, G. *Photochem. Photobiol.* **2007**, *83*, 897.
21. *Chemical Aspects of Photodynamic Therapy*; Bonnett, R., Ed.; Gordon and Breach Science Pub.: Amsterdam, 2000; Vol. 1.

22. Pineiro, M.; Gonsalves, A. M. D. R.; Pereira, M. M.; Formosinho, S. J.; Arnaut, L. G. *J. Phys. Chem. A* **2002**, *106*, 3787.
23. Pineiro, M.; Pereira, M. M.; Gonsalves, A. M. D. R.; Arnaut, L. G.; Formosinho, S. J. *J. Photochem. Photobiol. A: Chem.* **2001**, *138*, 147.
24. Rothmund, P. *J. Am. Chem. Soc.* **1935**, *57*, 2010.
25. Rothmund, P. *J. Am. Chem. Soc.* **1939**, *61*, 2912.
26. Rothmund, P.; Menotti, A. R. *J. Am. Chem. Soc.* **1941**, *63*, 267.
27. Aronoff, S.; Calvin, M. *J. Org. Chem.* **1943**, *8*, 205.
28. Calvin, M.; Ball, R. H.; Aronoff, S. *J. Am. Chem. Soc.* **1943**, *65*, 2259.
29. Ball, R. H.; Dorough, G. D.; Calvin, M. *J. Am. Chem. Soc.* **1946**, *68*, 2278.
30. Adler, A. D.; Longo, F. R.; Shergalis, W. *J. Am. Chem. Soc.* **1964**, *86*, 3145.
31. Adler, A. D.; Longo, F. R.; Finarelli, J. D.; Goldmacher, J.; Assour, J.; Korsakoff, L. *J. Org. Chem.* **1967**, *32*, 476.
32. Adler, A. D.; Sklar, L.; Longo, F. R.; Finarelli, J. D.; Finarelli, M. G. *J. Heterocycl. Chem.* **1968**, *5*, 669.
33. Dolphin, D.; Rousseau, K. *Tetrahedron Lett.* **1974**, *48*, 4251.
34. Barnett, G. H.; Hudson, M. F.; Smith, K. M. *J. Chem. Soc., Perkin Trans. 1* **1975**, 1401.
35. George, R. G.; Padmanabhan, M. *Polyhedron* **2003**, *22*, 3145.
36. Maestrin, A. P. J.; Tedesco, A. C.; Neri, C. R.; Gandini, M. E. F.; Serra, O. A.; Iamamoto, Y. *J. Braz. Chem. Soc.* **2004**, *15*, 708.
37. Bruckner, C.; Foss, P. C. D.; Sullivan, J. O.; Pelto, R.; Zeller, M.; Birge, R. R.; Crundwell, G. *Phys. Chem. Chem. Phys.* **2006**, *8*, 2402.
38. Habdas, J.; Boduszek, B. *Phosphorus, Sulfur Silicon* **2005**, *180*, 2039.
39. Biron, E.; Voyer, N. *Chem. Commun.* **2005**, 4652.
40. Raffy, Q.; Ricoux, R.; Mahy, J. P. *Tetrahedron Lett.* **2008**, *49*, 1865.
41. Lin, W.; Long, L.; Feng, J.; Wang, B.; Guo, C. *Eur. J. Org. Chem.* **2007**, 4301.
42. Gianferrara, T.; Giust, D.; Bratsos, I.; Alessio, E. *Tetrahedron* **2007**, *63*, 5006.
43. Skrzypek, D.; Madejska, I.; Habdas, J.; Dudkowiak, A. *J. Mol. Struct.* **2008**, *876*, 177.
44. Zhao, P.; Xu, L. C.; Huang, J. W.; Zheng, K. C.; Fu, B.; Yu, H. C.; Ji, L. N. *Biophys. Chem.* **2008**, *135*, 102.
45. Wu, L.; Hu, P.; Xiao, Y.; Zhang, M.; Zhang, L.; Weng, X.; Wu, X.; Zhou, X.; Cao, X. *Chem. Biodiversity* **2008**, *5*, 153.
46. Fagadar-Cosma, E.; Cseh, L.; Badea, V.; Fagadar-Cosma, G.; Vlascici, D. *Comb. Chem. High Throughput Screening* **2007**, *10*, 466.
47. Meunier, B. *Bull. Soc. Chim. Fr.* **1986**, 578.
48. Badger, G. M.; Jones, R. A.; Laslett, R. L. *Aust. J. Chem.* **1964**, *17*, 1028.
49. Traylor, P. S.; Dolphin, D.; Traylor, T. G. *J. Chem. Soc., Chem. Commun.* **1984**, 279.
50. Bortolini, O.; Ricci, M.; Meunier, B.; Friant, P.; Ascone, I.; Goulon, J. *Nouv. J. Chim.* **1986**, *10*, 39.
51. Williamson, M. M.; Prosser-McCartha, C. M.; Mukundan, S., Jr.; Hill, C. L. *Inorg. Chem.* **1988**, *27*, 1061.
52. Hill, C. L.; Williamson, M. M. *J. Chem. Soc., Chem. Commun.* **1985**, 1228.
53. (a) Varejão, J. M. T. V.; MSc Thesis, Coimbra, **1990**. (b) Pereira, M. M.; PhD Thesis, Coimbra, **1991**. (c) Bergman, F. *J. Am. Chem. Soc.* **1942**, *64*, 176. (d) Brock, D. J. H.; Holliman, F. G. *Tetrahedron* **1963**, *19*, 1911.
54. Gonsalves, A. M. A. R.; Varejão, J. M. T. B.; Pereira, M. M. *J. Heterocycl. Chem.* **1991**, *28*, 635.
55. Johnstone, R. A. W.; Nunes, M. L. P. G.; Pereira, M. M.; Gonsalves, A. M. D. R.; Serra, A. C. *Heterocycles* **1996**, *43*, 1423.
56. Kandasamy, K.; Shetty, S. J.; Puntambekar, P. N.; Srivastava, T. S.; Kundu, T.; Singh, B. P. *Chem. Commun.* **1997**, 1159.
57. Pineiro, M.; Carvalho, A. L.; Pereira, M. M.; Gonsalves, A. M. D. R.; Arnaut, L. G.; Formosinho, S. J. *Chem. Eur. J.* **1998**, *4*, 2299.
58. Schiavon, M. A.; Iwamoto, L. S.; Ferreira, A. G.; Iamamoto, Y.; Zanoni, M. V. B.; Assis, M. D. J. *Braz. Chem. Soc.* **2000**, *11*, 458.

59. Singh, B. P.; Vijaya, R.; Shetty, S. J.; Kandasamy, K.; Puntambekar, P. N.; Srivastava, T. S. *J. Porphyrins Phthalocyanines* **2000**, *4*, 659.
60. Murtinho, D.; Pineiro, M.; Pereira, M. M.; Gonsalves, A. M. D.; Arnaut, L. G.; Miguel, M. G.; Burrows, H. D. *J. Chem. Soc., Perkin Trans. 2* **2000**, 2441.
61. Pereira, M. M.; Muller, G.; Ordinas, J. I.; Azenha, M. E.; Arnaut, L. G. *J. Chem. Soc., Perkin Trans. 2* **2002**, 1583.
62. Grancho, J. C. P.; Pereira, M. M.; Miguel, M. G.; Gonsalves, A. M. R.; Burrows, H. D. *Photochem. Photobiol.* **2002**, *75*, 249.
63. Tomé, J. P. C.; Neves, M. G. P. M. S.; Tomé, A. C.; Cavaleiro, J. A. S.; Mendonça, A. F.; Pegado, I. N.; Duarte, R.; Valdeira, M. L. *Bioorg. Med. Chem.* **2005**, *13*, 3878.
64. Santos, I. C. M. S.; Rebelo, S. L. H.; Balula, M. S. S.; Martins, R. R. L.; Pereira, M. M. M. S.; Simões, M. M. Q.; Neves, M. G. P. M. S.; Cavaleiro, J. A. S.; Cavaleiro, A. M. V. *J. Mol. Cat. A: Chem.* **2005**, *231*, 35.
65. Safavi, A.; Movahedi, Z.; Mohajer, D.; Abdollahi, H. *Int. J. Chem. Kinet.* **2007**, *39*, 231.
66. Dehghani, H.; Sardrood, A. R. A. *Polyhedron* **2007**, *26*, 4263.
67. Mohajer, D.; Sakhtemanian, E.; Rayati, S.; Zakavi, S. *Spectrochim. Acta, Part A* **2008**, *69*, 998.
68. Monteiro, C. J. P.; Pereira, M. M.; Pinto, S. M. A.; Simões, A. V. C.; Sá, G. F. F.; Arnaut, L. G.; Formosinho, S. J.; Simões, S.; Wyatt, M. F. *Tetrahedron* **2008**, *64*, 5132.
69. Longo, F. R.; Finarelli, M. G.; Kim, J. B. *J. Heterocycl. Chem.* **1969**, *6*, 927.
70. Collman, J. P.; Gagne, R. R.; Reed, C. A.; Halbert, T. R.; Lang, G.; Robinson, W. T. *J. Am. Chem. Soc.* **1975**, *97*, 1427.
71. Gonsalves, A. M. D. R.; Pereira, M. M. *J. Heterocycl. Chem.* **1985**, *22*, 931.
72. van der Made, A. W.; Hoppenbrouwer, E. J. H.; Nolte, R. J. M.; Drenth, W. *Recl. Trav. Chim. Pays-Bas* **1988**, *107*, 15.
73. Lindsey, J. S.; Hsu, H. C.; Schreimen, I. C. *Tetrahedron Lett.* **1986**, *27*, 4969.
74. Lindsey, J. S.; Schreiman, I. C.; Hsu, H. C.; Kearney, P. C.; Marguerettaz, A. M. *J. Org. Chem.* **1987**, *52*, 827.
75. Wagner, R. W.; Lawrence, D. S.; Lindsey, J. S. *Tetrahedron Lett.* **1987**, *28*, 3069.
76. Vicente, M. G. H.; Shetty, S. J.; Wickramasinghe, A.; Smith, K. M. *Tetrahedron Lett.* **2000**, *41*, 7623.
77. Jux, N. *Org. Lett.* **2000**, *2*, 2129.
78. Reginato, G.; Di Bari, L.; Salvadori, P.; Guillard, R. *Eur. J. Org. Chem.* **2000**, 1165.
79. Smeets, S.; Asokan, C. V.; Motmans, F.; Dehaen, W. *J. Org. Chem.* **2000**, *65*, 5822.
80. Cornia, M.; Menozzi, M.; Ragg, E.; Mazzini, S.; Scarafoni, A.; Zanardi, F.; Casiraghi, G. *Tetrahedron* **2000**, *56*, 3977.
81. Bhyrappa, P.; Vijayanthimala, G.; Verghese, B. *Tetrahedron Lett.* **2002**, *43*, 6427.
82. Cammidge, A. N.; Öztürk, O. *J. Org. Chem.* **2002**, *67*, 7457.
83. Ye, B.-H.; Naruta, Y. *Tetrahedron*, **2003**, *59*, 3593.
84. Ruzié, C.; Gueyrard, D.; Boitrel, B. *Tetrahedron Lett.* **2004**, *45*, 1713.
85. Leroy, J.; Schöllhorn, B.; Syssa-Magalé, J.-L.; Boubekour, K.; Palvadeau, P. *J. Fluorine Chem.* **2004**, *125*, 1379.
86. Loiseau, F.; Campagna, S.; Hameurlaine, A.; Dehaen, W. *J. Am. Chem. Soc.* **2005**, *127*, 11352.
87. Tohara, A.; Sato, M. *J. Porphyrins Phthalocyanines* **2007**, *11*, 513.
88. Zhou, Y.; Ryu, E.-H.; Zhao, Y.; Woo, L. K. *Organometallics* **2007**, *26*, 358.
89. Lindsey, J. S.; MacCrum, K. A.; Tyhonas, J. S.; Chuang, Y.-Y. *J. Org. Chem.* **1994**, *59*, 579.
90. Lindsey, J. S.; Prathapan, S.; Johnson, T. E.; Wagner, R. W. *Tetrahedron* **1994**, *50*, 8941.
91. Geier, G. R.; Lindsey, J. S. *J. Porphyrins Phthalocyanines* **2002**, *6*, 159.
92. Geier, G. R.; Ciringh Y.; Li, F.; Haynes, D. M.; Lindsey, J. S. *Org. Lett.* **2000**, *2*, 1745.
93. Lindsey, J. S.; Wagner, R. W. *J. Org. Chem.* **1989**, *54*, 828.
94. Geier, G. R.; Riggs, J. A.; Lindsey, J. S. *J. Porphyrins Phthalocyanines* **2001**, *5*, 681.
95. Li, F.; Yang, K.; Tyhonas, J. S.; MacCrum, K. A.; Lindsey, J. S. *Tetrahedron* **1997**, *53*, 12339.
96. Guo, C.-C.; Tong, R.-B.; Li, K.-L. *Bioorg. Med. Chem.* **2004**, *12*, 2469.
97. Geier, G. R.; Lindsey, J. S. *J. Chem. Soc., Perkin Trans. 2* **2001**, 677.
98. Geier, G. R.; Lindsey, J. S. *J. Chem. Soc., Perkin Trans. 2* **2001**, 687.

99. Azenha, E. G.; Serra, A. C.; Pineiro, M.; Pereira, M. M.; de Melo, J. S.; Arnaut, L. G.; Formosinho, S. J.; Gonsalves, A. M. D. R. *Chem. Phys.* **2002**, *280*, 177.
100. Lin, W.; Peng, D.; Wang, B.; Long, L.; Guo, C.; Yuan, J. *Eur. J. Org. Chem.* **2008**, 793.
101. Wang, N.; Li, Y.; Lu, F.; Liu, Y.; He, X.; Jiang, L.; Zhuang, J.; Li, X.; Li, Y.; Wang, S.; Liu, H.; Zhu, D. *J. Polym. Sci., Part A: Polym. Chem.* **2005**, *43*, 2851.
102. Youngblood, W. J.; Gryko, D. T.; Lammi, R. K.; Bocian, D. F.; Holten, D.; Lindsey, J. S. *J. Org. Chem.* **2002**, *67*, 2111.
103. Speck, M.; Niethammer, D.; Senge, M. O. *J. Chem. Soc., Perkin Trans. 2* **2002**, 455.
104. Amessou, M.; Carrez, D.; Patin, D.; Sarr, M.; Grierson, D. S.; Croisy, A.; Tedesco, A. C.; Maillard, P.; Johannes, L. *Bioconjugate Chem.* **2008**, *19*, 532.
105. Séverac, M.; Le Pleux, L.; Scarpaci, A.; Blart, E.; Odobel, F. *Tetrahedron Lett.* **2007**, *48*, 6518.
106. Foxon, S. P.; Smith, J. R. L.; O'Brien, P.; Reginato, G. *J. Chem. Soc., Perkin Trans. 2* **2001**, 1145.
107. Serra, A. C.; Pineiro, M.; Gonsalves, A. M. D. R.; Abrantes, M.; Laranjo, M.; Santos, A. C.; Botelho, M. F. *J. Photochem. Photobiol., B* **2008**, *92*, 59.
108. Sharghi, H.; Nejad, A. H. *Helv. Chim. Acta* **2003**, *86*, 408.
109. Sharghi, H.; Nejad, A. H. *Tetrahedron* **2004**, *60*, 1863.
110. Xu, T.; Lu, R.; Liu, X.; Chen, P.; Qiu, X.; Zhao, Y. *J. Org. Chem.* **2008**, *73*, 1809.
111. Drain, C. M.; Gong, X. *Chem. Commun.* **1997**, 2117.
112. Warner, M. G.; Succaw, G. L.; Hutchison, J. E. *Green Chem.* **2001**, *3*, 267.
113. Vignaud, Y.; Granet, R.; Krausz, P. *J. Porphyrins Phthalocyanines* **2006**, *10*, 937.
114. Polshettiwar, V.; Varma, R. S. *Acc. Chem. Res.* **2008**, *41*, 629.
115. Petit, A.; Loupy, A.; Maillard, P.; Momenteau, M. *Synth. Commun.* **1992**, *22*, 1137.
116. Chauhan, S. M. S.; Sahoo, B. B.; Srinivas, K. A. *Synth. Commun.* **2001**, *31*, 33.
117. Liu, M. O.; Tai, C. H.; Wang, W. Y.; Chen, J. R.; Hu, A. T.; Wei, T. H. *J. Organomet. Chem.* **2004**, *689*, 1078.
118. De Paula, R.; Faustino, M. A. F.; Pinto, D. C. G. A.; Neves, M. G. P. M. S.; Cavaleiro, J. A. S. *J. Heterocycl. Chem.* **2008**, *45*, 453.
119. Nascimento, B. F. O.; Pineiro, M.; Gonsalves, A. M. D. R.; Silva, M. R.; Beja, A. M.; Paixão, J. A. *J. Porphyrins Phthalocyanines* **2007**, *11*, 77.
120. Lucas, R.; Vergnaud, J.; Teste, K.; Zerrouki, R.; Sol, V.; Krausz, P. *Tetrahedron Lett.* **2008**, *49*, 5537.
121. *Ionic Liquids in Synthesis, Second Edition*; Wasserscheid, P.; Welton, T., Eds.; Wiley-VCH: Weinheim, 2008.
122. Kitaoka, S.; Nobuoka, K.; Ishikawa, Y. *Chem. Commun.* **2004**, 1902.
123. Kitaoka, S.; Nobuoka, K.; Ishikawa, Y. *Tetrahedron* **2005**, *61*, 7678.
124. Onaka, M.; Shinoda, T.; Izumi, Y.; Nolen, E. *Tetrahedron Lett.* **1993**, *34*, 2625.
125. Kishan, M. R.; Rani, V. R.; Murty, M. R. V. S.; Devi, P. S.; Kulkarni, S. J.; Raghavan, K. V. *J. Mol. Cat. A: Chem.* **2004**, *223*, 263.
126. Kishan, M. R.; Rani, V. R.; Devi, P. S.; Kulkarni, S. J.; Raghavan, K. V. *J. Mol. Cat. A: Chem.* **2007**, *269*, 30.
127. Algarra, F.; Esteves, M. A.; Fornés, V.; García, H.; Primo, J. *New J. Chem.* **1998**, 333.
128. Shinoda, T.; Izumi, Y.; Onaka, M. *J. Chem. Soc., Chem. Commun.* **1995**, 1801.
129. Nakagaki, S.; Xavier, C. R.; Wosniak, A. J.; Mangrich, A. S.; Wypych, F.; Cantão, M. P.; Denicoló, I.; Kubota, L. T. *Colloids Surf., A* **2000**, *168*, 261.
130. Onaka, M.; Shinoda, T.; Izumi, Y.; Nolen, E. *Chem. Lett.* **1993**, 117.
131. Laszlo, P.; Luchetti, J. *Chem. Lett.* **1993**, 449.
132. Izumi, Y.; Urabe, K.; Onaka, M. *Microporous Mesoporous Mater.* **1998**, *21*, 227.
133. Chauhan, S. M. S.; Singh, R.; Gulati, A. *Indian J. Heterocycl. Chem.* **2000**, *9*, 231.

Abbreviations

Chloranil:	2,3,5,6-Tetrachloro-1,4-benzoquinone
DDQ:	2,3-Dichloro-5,6-dicyanobenzoquinone
IL:	Ionic liquid
IUPAC:	International Union of Pure and Applied Chemistry

LD-MS:	Laser desorption mass spectrometry
MW:	Microwave irradiation
NMR:	Nuclear magnetic resonance
TDCPP:	<i>meso</i> -Tetra(2,6-dichlorophenyl)porphyrin
TDOMePP:	<i>meso</i> -Tetra(2,6-dimethoxyphenyl)porphyrin
TFA:	Trifluoroacetic acid
TLC:	Thin layer chromatography
TMP:	<i>meso</i> -Tetramesitylporphyrin
TPP:	<i>meso</i> -Tetrakisphenylporphyrin

1,2- AND 1,3-OXAZOLOPYRIDINES: VERSATILE BUILDING BLOCKS FOR THE HETEROCYCLIC SYNTHESIS

Gianluca Giorgi and Fabio Ponticelli

Department of Chemistry, University of Siena, via A. Moro 2, I-53100 Siena, Italy

(e-mail: ponticelli@unisi.it)

Abstract. 1,3- And 1,2-oxazolopyridines are well known and characterized class of heterocyclic compounds having a wide range of properties and applications. Different reactions, mainly consisting in derivatization/cyclization of suitable acyclic compounds, can be used for their preparation. Both thermal and photochemical modifications of their annular system are possible, opening the easy access to a wide family of monocyclic and condensed ring systems.

Contents

1. Introduction
 - 1.1. Availability
 - 1.1.1. Oxazolopyridines
 - 1.1.2. Isoxazolopyridines
 2. Structural characterization
 - 2.1. Nuclear Magnetic Resonance
 - 2.2. X-Ray crystallography
 - 2.3. Mass spectrometry
 3. Chemical properties
 - 3.1. General aspects
 - 3.2. Oxazolopyridines reactivity
 - 3.3. Isoxazolopyridine reactivity
 - 3.3.1. Thermal reactivity
 - 3.3.2. Photochemical reactions
 4. Conclusions
- Acknowledgments
- References

1. Introduction

The fusion of a pyridine with 1,3- or 1,2-oxazole ring gives rise to the condensed heterocycles reported in the Scheme 1. Compounds **9–12** are the aza-analogues of benzo[*c*]isoxazole, the other of the corresponding benzo[*d*]-fused molecules.

As reported in the present review, this wide family of compounds shows a very interesting chemical reactivity, due to the easy of functionalization and/or rearrangement of both ring systems. Consequently, 1,2- and 1,3-oxazolopyridines can be considered useful building blocks in the heterocycles syntheses.

Biological significance of this class of compounds, with particular attention to the oxazolopyridines **1–4** is also well documented. Taking into account very recent articles only, they are studied as histamine H3

receptor ligands,¹ sirtuin [Silent information regulator 2 (Sir2) proteins] and somatostatin receptor modulators,² enzymatic inhibitors,³ for treatment of muscular dystrophy, cachexia, atherosclerosis, CNS disorders and nonsense suppression.⁴ Quantum chemical and modelling investigations on biological activities of oxazolopyridines are also reported.⁵

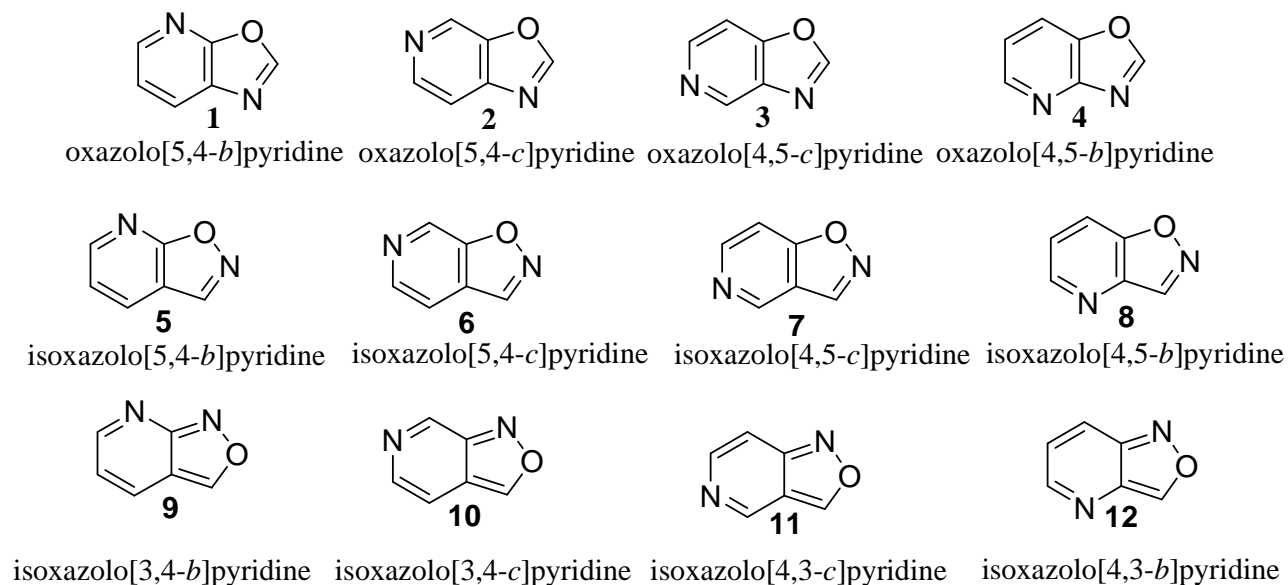

Scheme 1

Luminescence properties of some oxazolopyridines are useful for the preparation of image formation and recording materials, electroluminescent devices and for fluorescent staining of DNA.⁶

1.1. Availability

1.1.1. Oxazolopyridines

Synthetic accesses to the title compounds are well known and were widely described in recent reviews.⁷ The oxazolopyridines are usually prepared by acylation/cyclization of suitable *o*-aminopyridinols. Some improvements to this protocol were recently introduced. For instance, reaction of *o*-aminopyridinols with carboxylic acids to give amides **13**, followed by condensation with exachloroethane/triphenylphosphine at room temperature, affords oxazolopyridines **14** in very good yields (Scheme 2). The mild reaction conditions are compatible with a wide number of functional groups.⁸

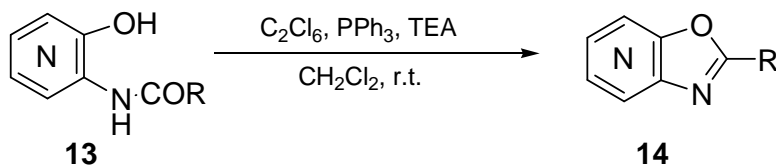

Scheme 2

In addition, microwave irradiation offers a rapid and very useful way to prepare a library of oxazolopyridines. The reaction can be carried out directly on the acylaminopyridinols alone,⁹ or in presence of silica gel,¹⁰ ionic liquids,¹¹ Bi(III) salts and solvents¹² or phase transfer catalyst and bases.¹³ The latter reaction is reported in the Scheme 3.

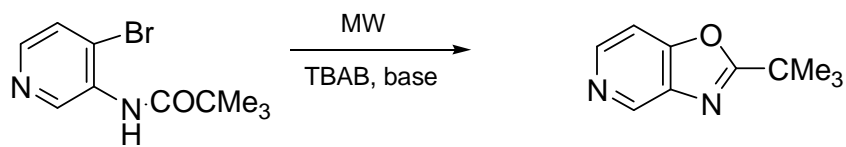

Scheme 3

1.1.2. Isoxazolopyridines

The bicyclic system of isoxazolopyridines can be obtained by using a five or a six membered ring as starting material. As an example, the preparation of isoxazolo[5,4-*b*]pyridines is depicted in Scheme 4.

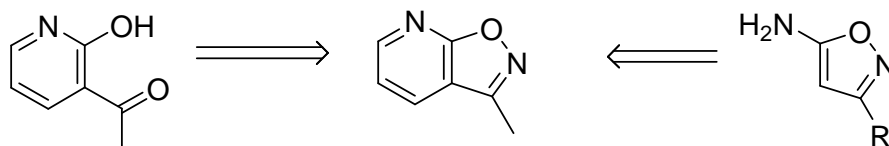

Scheme 4

According to the type of fusion and substitution pattern required, different kinds of reagents and starting materials can be used.⁷ In a recent procedure (Scheme 5), activation of the 5-methylisoxazole-4-carboxamide by butyl lithium followed by reaction with Weinreb amide affords a library of isoxazolo [4,5-*c*]pyridine-4-ones **15**, useful as activators of nuclear receptor related 1 (NURR1) signalling pathway.¹⁴ Other procedures for recent preparation of isoxazolopyridines **16**, **17** and *N*-oxides **18** have been also reported (Scheme 5).^{15,16}

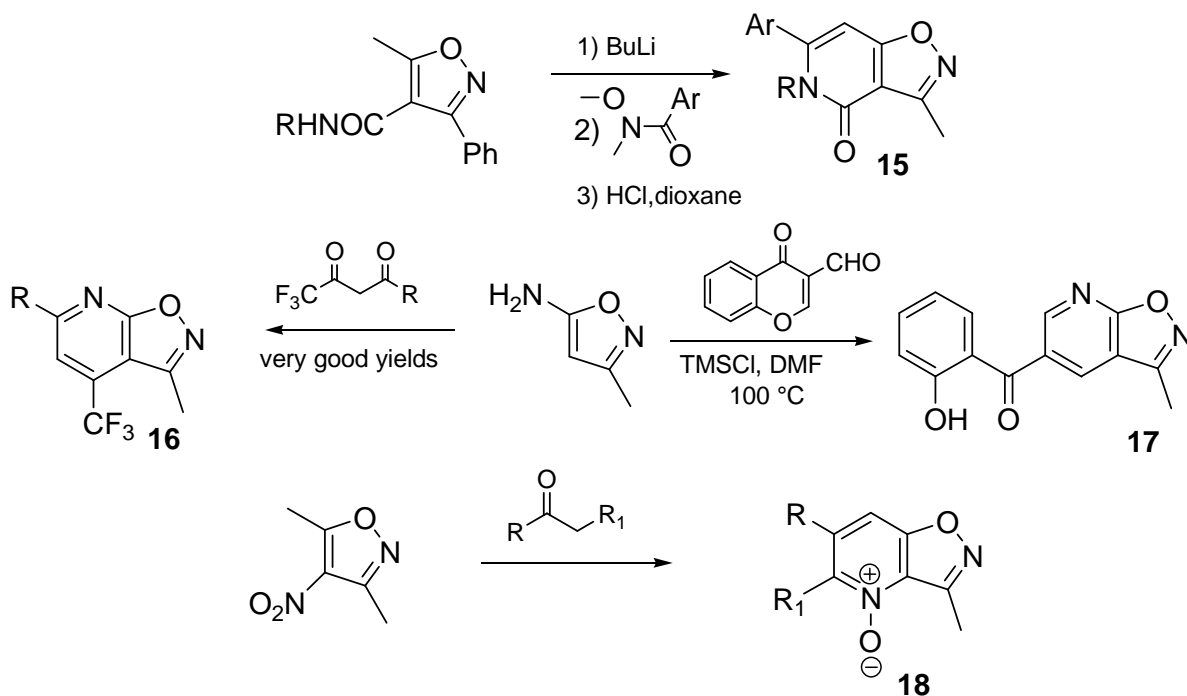

Scheme 5

For compounds **9–12** very few data are reported in the literature. Some possible synthetic approaches involve oxidative cyclization of *o*-aminopyridyl ketones **19** or thermal reactions of *o*-azidopyridyl ketones **20** and *o*-nitropyridyl activated esters **21** (Scheme 6).^{17,18}

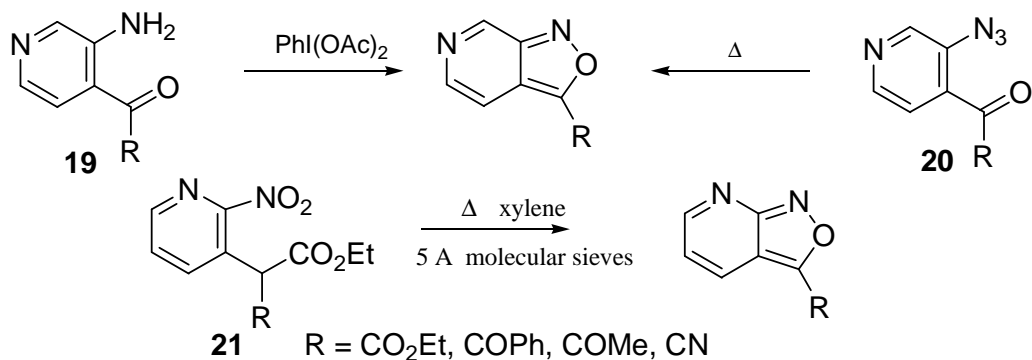

In conclusion, a plethora of differently substituted derivatives of all these heterocycles are well known. However, it is to be noted that parent compounds **2**, **6**, **7** and **10–12** are not reported in the literature.

2. Structural characterization

2.1. Nuclear Magnetic Resonance

^1H and ^{13}C -NMR data of title compounds have been well described. It is to be noted that 1,2- and 1,3-oxazolopyridines are hardly distinguished on the basis of chemical shift and coupling constant pattern considerations, due to the similarity of data of the two corresponding molecules. However, when a methyl substituent is present on the five membered ring, an easy structure assignment can be done based on the ^{13}C spectrum. In fact, in the case of isoxazolopyridines $\delta\text{Me}=9.0\text{--}12.5$ ppm, whereas in the corresponding 1,3-oxazolopyridines a deshielding effect is present ($\delta\text{Me}=14.0\text{--}14.8$ ppm). Significant differences are also found for C2/C3, C3a and C7a.¹⁹

2.2. X-Ray crystallography

Only few oxazolopyridine derivatives have been characterized by X-ray crystallography. 2-((2'-Cyclopropylamino)-3'-pyridyl)-7-methyloxazolo[5,4-*b*]pyridine²⁰ has been obtained as alternative cyclization product by heating the 2'-alkylamido-amine derivative with sodium carbonate in dimethylformamide. Its crystal structure is depicted in Figure 1.

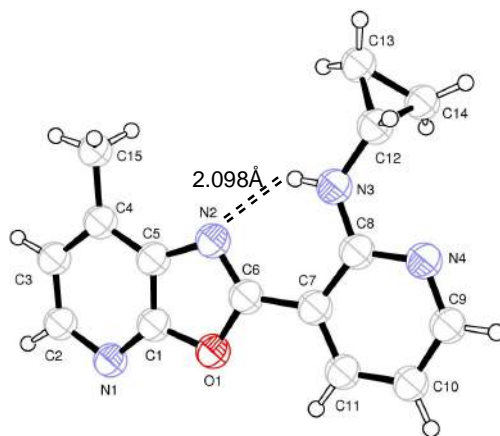

Figure 1. Crystal structure of 2-((2'-cyclopropylamino)-3'-pyridyl)-7-methyloxazolo-[5,4-*b*]pyridine.²⁰ Ellipsoids are in arbitrary units.

A strong hydrogen bonding interaction between N(3)-H \cdots N(2) (d H \cdots N=2.098Å) allows the formation of a six-membered ring and it constrains the pendant pyridine ring to be almost coplanar with the oxazole moiety. The dihedral angle between the two planes is 4.3°. Further, a non-conventional hydrogen bond occurs between C(11)-H and O(1) with a distance H \cdots O of 2.456Å.

In 2,5-diphenyl-7-methyloxazo[5,4-*b*]pyridine, the two phenyl rings form a dihedral angle of 4° [Ph at C(1)] and 22° [Ph at C(2)] with the oxazolopyridine system (Figure 2).²¹ Two non conventional hydrogen bonding interactions are present: one intramolecular between the oxygen atom and a hydrogen of the phenyl ring in position 2 of the oxazole moiety [O(1) \cdots H-C(13), d O \cdots H= 2.472Å] and another intermolecular between the pyridine N and a hydrogen atom of the pendant phenyl ring in position 2 of the oxazole moiety (d N \cdots H= 2.525Å, Figure 2).

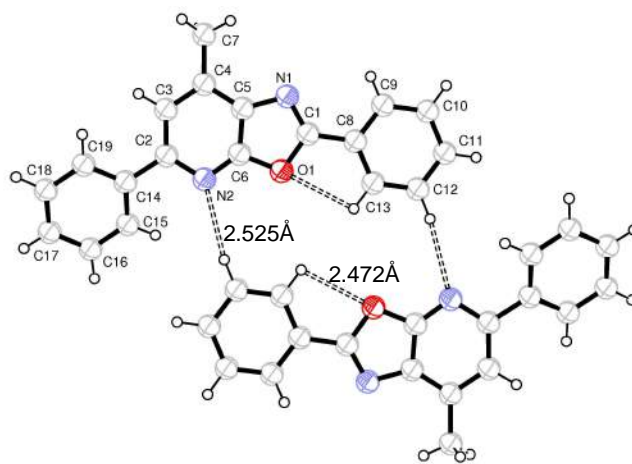

Figure 2. View of two molecules (x,y,z and $1-x, -y, -z$) in the crystal structure of 2,5-diphenyl-7-methyloxazo[5,4-*b*]pyridine.²¹ Hydrogen bonding interactions are evidenced as dashed lines. Ellipsoids are in arbitrary units.

The crystal structures of a series of methyl(is)oxazolopyridines have been recently determined.²² Their crystal data are summarized in Table 1. Most of the isomeric analogues crystallize in centric space group and their cell parameters are quite similar each other, with some exceptions. One is represented by 3-methylisoxazo[4,5-*b*]pyridine which, differently from the other analogues, crystallizes in a acentric group, indicating crystal chirality. Further its cell volume is one half in comparison with those of the other isoxazo analogues, implying that only two molecules are contained in the cell. Differently from the others, 2-methyloxazo[5,4-*b*]pyridine shows a cell that contains eight molecules, while the asymmetric unit of 3-methylisoxazo[4,5-*c*]pyridine is distinctively constituted by two crystallographic independent molecules. All the derivatives show similar geometrical parameters.

To evaluate the role playing by regiochemistry and structure on the supramolecular assessment, their packing and in particular stacking π - π interactions between the aromatic systems have been studied (Table 2). Two main arrangements are found: one consists in parallel layers of translated molecules. It is shown by two isoxazolopyridine derivatives (panels 1 and 3 in Table 2) with interplanar distances equal to 3.481 and 3.364Å, respectively. In the other isoxazo and in the three oxazo derivatives stacking π - π interactions between the aromatic systems occur between molecules related by an inversion centre. It implies that pyridine is mainly stacked with the (is)oxazole moiety and *viceversa*. The interplanar distances range

between 3.330 and 3.579 Å. In the latter case (panel 6, Table 2), only the oxazole moiety is involved in stacking with another oxazole with a N...O distance equal to 3.627 Å, while the pyridine lies on the methyl group of the other molecule.²²

Table 1. Crystal data for methyl(is)oxazolopyridines.

Formula: C₇H₆N₂O M 134.14 Radiation graphite monochr.: MoKα (λ= 0.71073 Å)

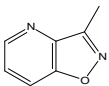
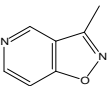
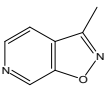
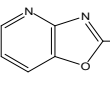
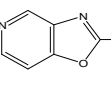
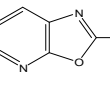
						
Crystal System	Monoclinic	Triclinic	Monoclinic	Monoclinic	Monoclinic	Monoclinic
Space Group	Pn (n. 7)	P-1 (n. 2)	P2 ₁ /n (n. 14)	P2 ₁ /n (n. 14)	P2 ₁ /c (n. 14)	C 2/c (n. 15)
<i>a</i> /Å	3.849(1)	7.262(2)	3.892(1)	9.477(1)	6.806(1)	12.806(1)
<i>b</i> /Å	7.383(2)	8.896(2)	5.525(2)	6.777(1)	14.406(3)	8.274(1)
<i>c</i> /Å	11.350(3)	10.058(3)	28.964(10)	10.345(1)	6.750(1)	12.096(1)
α/°		86.00(2)				
β/°	96.92(2)	75.42(2)	90.35(2)	104.06(1)	105.77(2)	97.21(1)
γ/°		83.83(2)				
U/Å ³	320.2(1)	624.7(3)	622.8(4)	644.5(1)	636.9(2)	1271.5(2)
Z	2	4	4	4	4	8
F(000)	140	280	280	280	280	560
Dc/g cm ⁻³	1.391	1.426	1.431	1.382	1.399	1.401
μ (Mo-Kα)/cm ⁻¹	0.097	0.100	0.100	0.097	0.098	0.098
Scan mode	ω	ω	ω	ω	ω	ω
Scan range/°	3≤θ≤25	3≤θ≤25	2≤θ≤25	2≤θ≤25	2≤θ≤25	2≤θ≤27
Scan width/°	1.7	1.5	1.2	1.0	1.3	1.1
Scan speed/° min ⁻¹	3.0	3.0	3.0	3.0	3.0	3.0
Temperature /°C	-90	-90	-90	-90	-90	-90
Unique reflections	724	2186	1088	1140	1070	1115
	(R _{int} =0.07)	(R _{int} =0.05)	(R _{int} =0.10)	(R _{int} =0.01)	(R _{int} =0.03)	(R _{int} =0.01)
N. parameters refined	95	190	94	94	93	94
R ₁ (I > 2σ(I))	0.042	0.128	0.066	0.038	0.044	0.034
wR ₂ (I > 2σ(I))	0.110	0.303	0.137	0.086	0.108	0.078

Another derivative, *i.e.* 6,6'-dibromo-3,3'-dimethyl-4,4'-biisoxazolopyridine, has been recently characterized by X-ray crystallography (Figure 3).²² The structure crystallizes in the monoclinic crystal system, space group C2/c and its asymmetric unit is constituted by half molecule. The dihedral angle between the least-squares planed defined by the two isoxazolopyridine nuclei is 41.27°. The packing arrangement consists in interactions between the pyridine rings of two molecules with an interplanar distance of 3.458 Å.

Table 2. Perpendicular view to the molecular plane of stacking π - π interactions between the aromatic systems in methyl(is)oxazolopyridines. Symmetry operations and interplanar distances (\AA) are also reported.

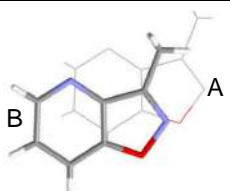
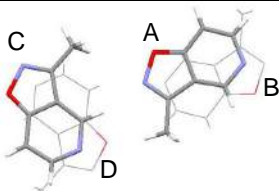
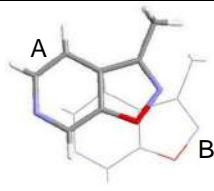
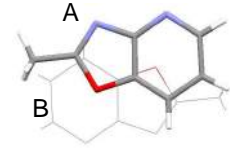
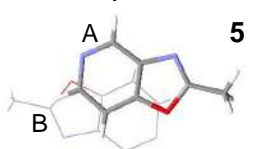
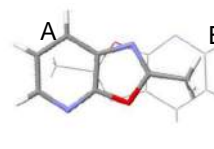
		
3.481	3.423 3.444	3.364
A: x, y, z B: $-I+x, y, z$	A, D: x, y, z B: $-x, I-y, I-z$ C: $I-x, 2-y, -z$	A: x, y, z B: $-I+x, y, z$
		
3.456	3.330	3.579
A: x, y, z B: $I-x, -y, -z$	A: x, y, z B: $I-x, -y, -z$	A: x, y, z B: $-x, -y, I-z$

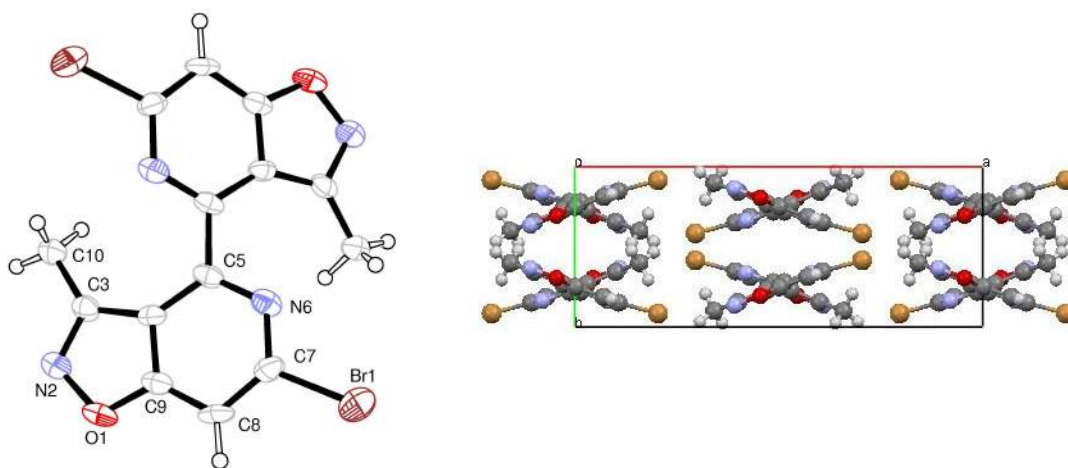

Figure 3. Crystal structure of 6,6'-dibromo-3,3'-dimethyl-4,4'-biisoxazolo[4,5-*c*]pyridine (left) and packing arrangement viewed along *c* axis (right). Ellipsoids enclose 50% probability.²²

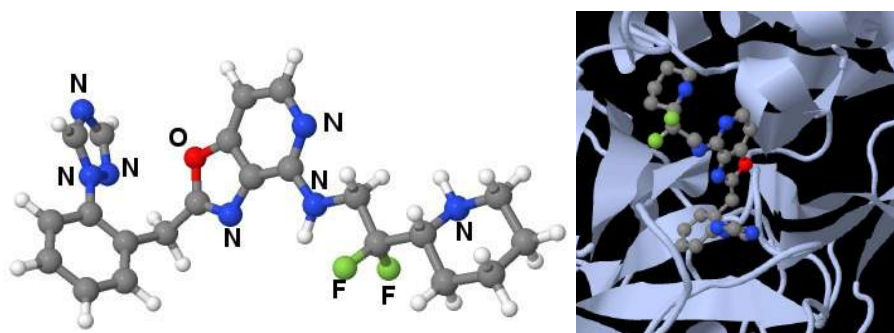

Figure 4. Crystal structure of (R)-2-(2-(1H-1,2,4-triazol-1-yl)benzyl)-N-(2,2-difluoro-2-(piperidin-2-yl)ethyl)oxazolo[4,5-*c*]pyridin-4-amine (left) and its complex with thrombin (right).

It has been shown that a series of 1,3-oxazolo[4,5-*c*]pyridine derivatives are thrombin-factor Xa inhibitors.^{3f} The crystal structure of a representative member with thrombin shows the existence of weak hydrogen bonding interactions between the heterocycle and thrombin. In particular, the oxazole nitrogen is engaged in hydrogen bonding with Gly-216 with a N...N distance of 3.6Å (Figure 4).

2.3. Mass spectrometry

Simple (is)oxazolopyridines are apolar and volatile molecules and can be ionized by electron ionization, while for substituted derivatives, characterized by a higher polarity, other ionization techniques, such as electrospray, can be used.

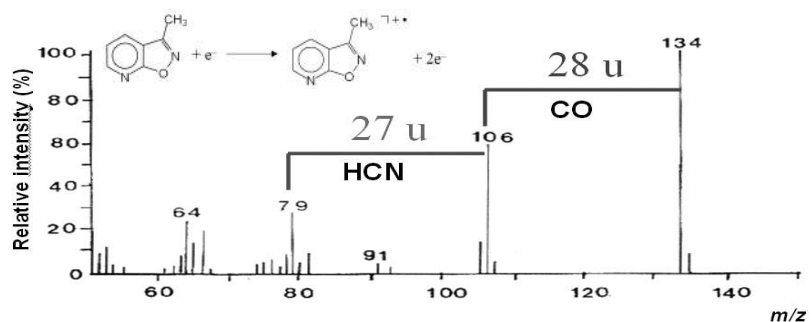

Figure 5. Electron ionization mass spectrum of 3-methylisoxazolo[5,4-*b*]pyridine.

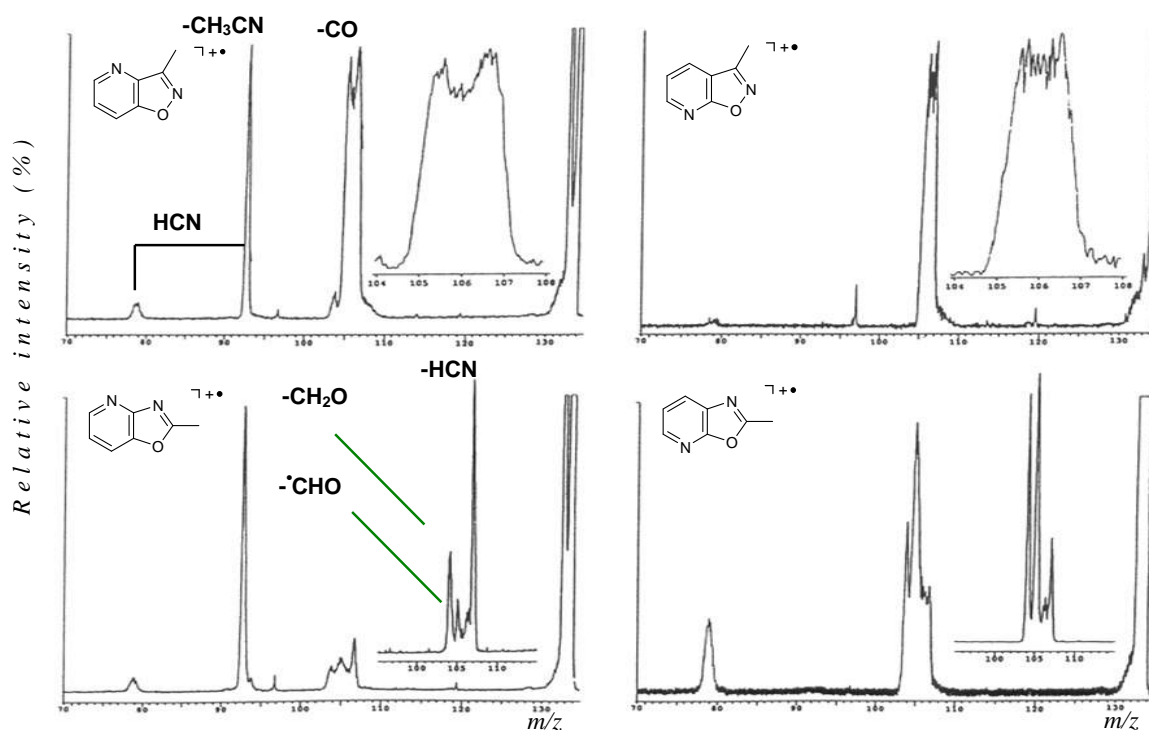

Figure 6. Metastable mass ion kinetic energy spectra of methylisoxazolopyridines (top row) and their oxazole isomers (bottom row).

The electron ionization (EI) mass spectra of 3-methyl-1,2- and 2-methyl-1,3-oxazolopyridines show the molecular ion and abundant fragment ions.^{23a} Although it is possible to well differentiate

3-methylisoxazolo[5,4-*b*]pyridine and 3-methylisoxazolo[4,5-*b*]pyridine from the others, it is very difficult to distinguish among corresponding compounds of the 1,2- and 1,3-oxazole series. This is due to the fact that the same fragmentation pattern, which consists mainly of losses of CO, HCN and CH₃CN from the molecular ion, occurs in the source region for all of these compounds (Figure 5).^{23a}

Tandem mass spectrometry and mass-analyzed ion kinetic energy (MIKE) experiments on molecular ions and abundant fragments formed by CO and CH₃CN losses show characteristic differences that allow distinction among the isomers dependent on the position of the nitrogen atom in the pyridine ring and distinction of isoxazole derivatives from oxazoles (Figure 6).^{23b}

These data indicate that the isomerization of the isoxazole moiety to oxazole proposed for other analogous compounds does not occur in these heterocyclic systems. Molecular orbital calculations carried out both on neutral molecules and on molecular and fragment ions have allowed to elucidate the gas-phase decomposition pathways followed by these compounds.^{23b}

The electron ionization mass spectrum of 2-((2'-cyclopropylamino)-3'-pyridyl)-7-methyloxazolo[5,4-*b*]pyridine shows intense molecular ion at *m/z* 266 together with fragment ions at *m/z* 251, that constitute the base peak, and another fragment ion at *m/z* 238.²⁰ They are due to losses of [•]CH₃ and C₂H₂, as confirmed by accurate mass measurements. In particular, the loss of ethylene, reasonably occurring from the pendant cyclopropyl moiety, might yield a fused four membered ring (Scheme 7).

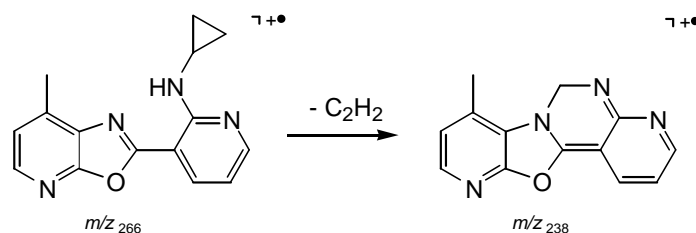

3. Chemical properties

3.1. General aspects

In spite of their very similar structure, oxazolopyridines and isoxazolopyridines show a different chemical reactivity.

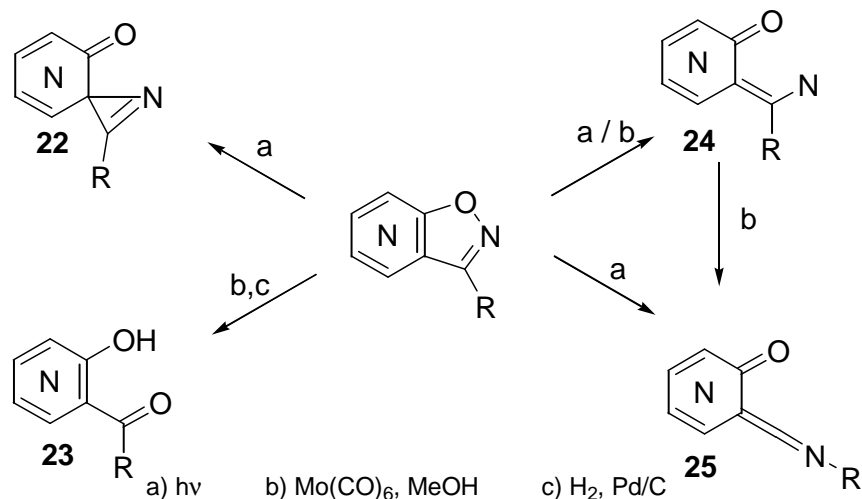

Thus, the first system is quite inert towards catalytic hydrogenation and ultraviolet irradiation (at least in absence of suitable reagents, see below), whereas it is very subject to acidic hydrolysis. On the other hand, the latter is stable to hydrolytic conditions but the N–O bond is easily cleaved by catalytic hydrogenation, reaction with molybdenum hexacarbonyl or by photon absorption, giving *spiro*-azirinopyridones **22**, acyl (or imino) pyridones **23**, nitrenes **24** or ketenimines **25** (Scheme 8).

Taking into account that the condensation of isoxazole and pyridine systems strongly increases mobility of the halogens on the latter ring towards nucleophilic substitutions, a large family of 4-, 6- or 4,6-functionalized derivatives can be easily prepared. In a second time, masked functionality inside isoxazole nucleus can be revealed, according to the possibilities outlined in Scheme 8. Thus, in this way, very interesting procedures to non usual heterocyclic systems can be achieved (see below).

3.2. Oxazolopyridines reactivity

A catalytic amount of acids is sufficient for hydrolytic ring opening to give *o*-acylaminopyridones **26** (Scheme 9).^{24a}

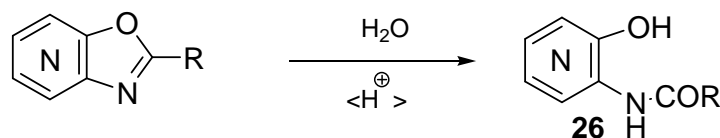

Scheme 9

As a consequence, only careful attention to the experimental conditions can avoid this type of reactivity. For example, during the preparation of heterocyclic dyes by coupling of 2-aryloxazolopyridines with diazonium salts, depending on the reaction temperature, both compound **27** and the corresponding amide **28** are formed (Scheme 10).^{24b,c}

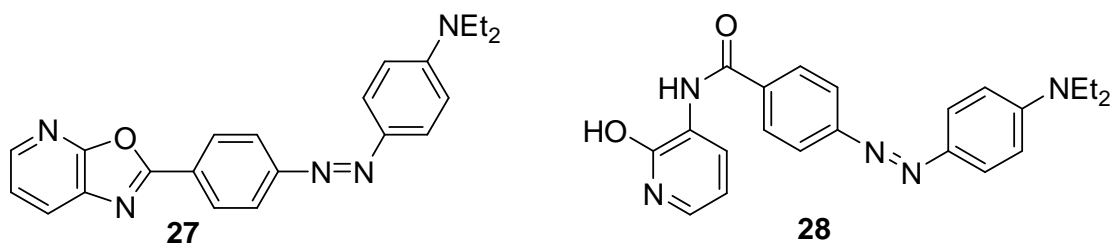

Scheme 10

On the other hand, the oxazole system is not subject to catalytic hydrogenation, allowing the selective reduction of acyl substituent to hydroxyethyl analogue or chlorine atoms removal to give unsubstituted oxazolopyridines.²⁵

In view of the biological activity of these substrates, derivatization of the system has been widely utilized. Homolytic acylation of 2-aryloxazo[4,5-*b*]- or [5,4-*b*] pyridines can be achieved by reaction with aldehydes or α -oxocarboxylic acids in presence of *tert*-butyl hydroperoxide or ammonium peroxodisulphate. The former heterocyclic system is more reactive while the latter is more selective, giving only substitution in position 7 (Scheme 11).^{26a}

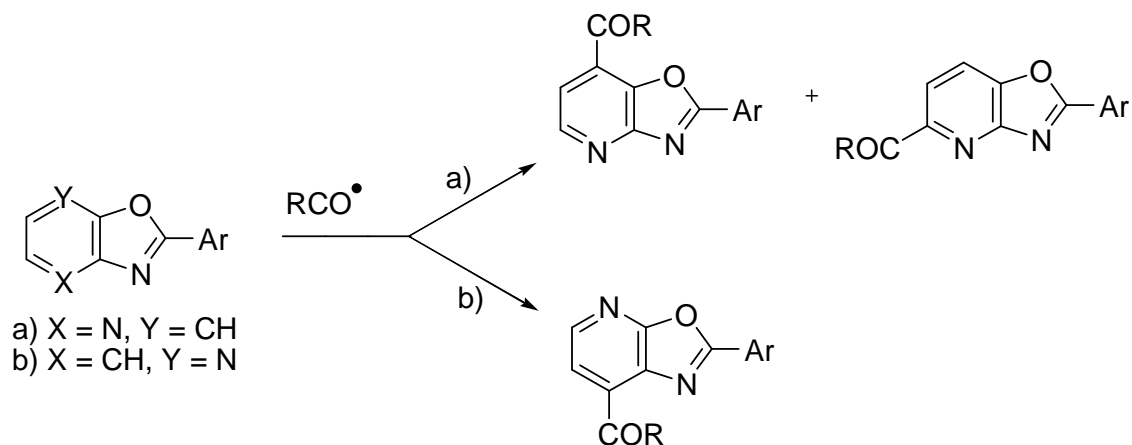

Scheme 11

Lithiation of 2-phenyloxazopyridines by LDA in THF at $-78\text{ }^{\circ}\text{C}$ selectively occurs in position 7. Further reaction with electrophyles allows the easy preparation of a series of secondary alcohols (**29**) and, by oxidation, of the corresponding ketones **30** (Scheme 12). In each case, the five membered ring is unaffected during the reaction. Analogous results were obtained in the case of the [5,4-*b*] system.^{26b}

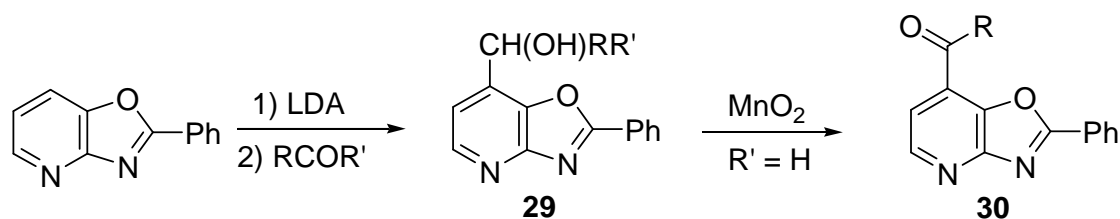

Scheme 12

Pd catalyzed attack on parent oxazolo[4,5-*b*]pyridine in 2-position offers a very good synthetic protocol for the access to the 2-aryloxazoles **31** (Scheme 13). The reaction conditions are very mild, allowing also the use of chiral arylating agents without racemization. The reaction mechanism is accounted on the basis of the anionic intermediate formed by facile deprotonation of 2-position of the oxazole ring.²⁷

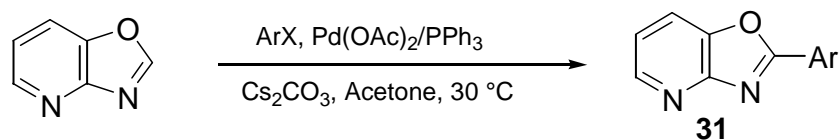

Scheme 13

The oxazole nucleus is quite stable towards ultraviolet irradiation. In presence of suitable reagents, photochemical attack on pyridine ring eventually occurs. Thus, irradiation of a dilute solution of oxazopyridine **32** in diethyl ether gives the 4-ethyl derivative **33** through a radical mechanism (Scheme 14). No ring opening products are found.^{24a}

A detailed study of photoreactions of 2-methyloxazopyridines with unsaturated molecules was carried out. Surprisingly, whereas compounds belonging to the **2–4** series were unable to react, 2-methyloxazolo[5,4-*b*]pyridine (type **1**) easily gives photocycloaddition with alkenes, mainly on the six membered ring. The primary photoadducts undergo further thermal/photochemical rearrangement to give a

lot of interesting heterocyclic derivatives, as outlined in Schemes 15–19. The electron attracting or donating character of the alkene strongly affects the reaction mechanism and the structure of the final products. In the case of an electron poor alkene (*i.e.* acrylonitrile) the oxazoloazocines **34** and **36** and the *bis*-adduct **35** were obtained (Scheme 15). The complete stereochemical assignment of **35** has been done by X-ray diffractometric analysis (Figure 7).^{28a}

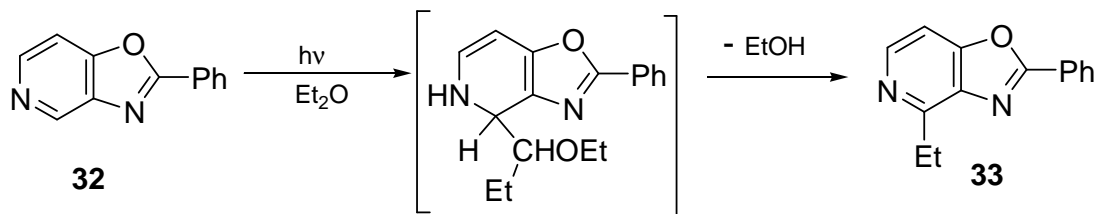

Scheme 14

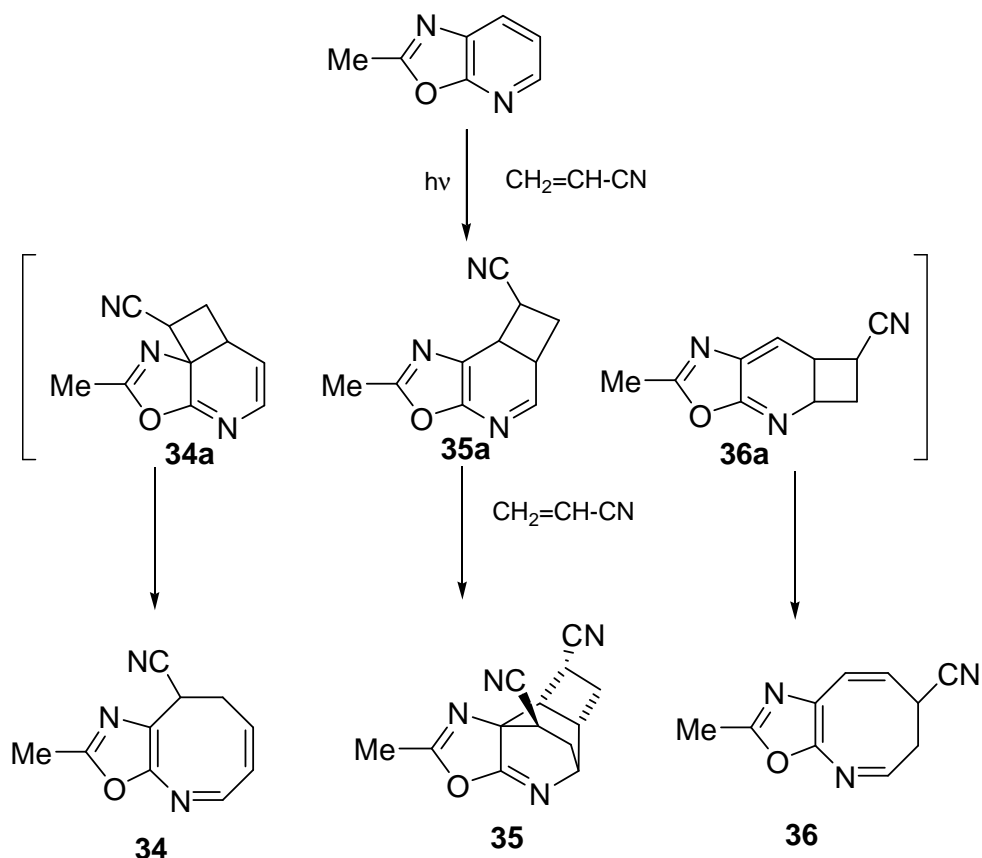

Scheme 15

The crystal packing of compound **35** shows a network of hydrogen bonding interactions mainly involving the nitrogen atoms of both the cyano and the oxazole moieties.

These compounds can be formed by the 2+2 photoaddition of acrylonitrile on 3a-4, 4,5 and 5,6 bonds to give cyclobutapyridines **34a**, **35a** or **36a**, respectively. Evolution of these intermediates by ring opening or by further acrylonitrile addition affords the final products **34–36**. When the above photoreaction was carried out using *cis*- or *trans*-2-butenitrile, only the azocines **37a** or **37b** were obtained (Scheme 16). In this case the site specificity is strongly increased and the reaction is stereospecific.

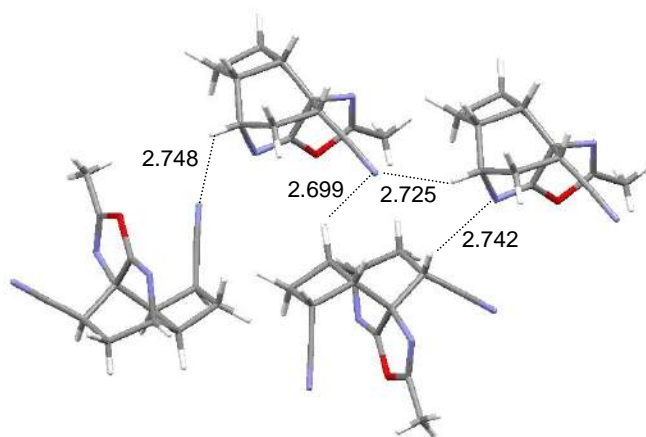
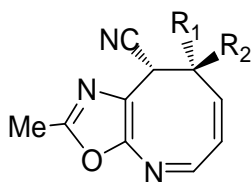

Figure 7. Crystal packing of compound **35**. N \cdots H interactions are evidenced (distances in Å).



37 a) R₁ = Me, R₂ = H ; b) R₁ = H, R₂ = Me

Scheme 16

Irradiation of the same oxazopyridine with methacrylonitrile gave, in addition to the expected azocines **38** and **39**, a new type of compounds, identified as a *Z/E* mixture of fulvenes **40** (Scheme 17). The structure of *Z* isomer was unambiguously assigned by X-ray crystallographic analysis. It is to be noted that compounds **40**, absent in the crude reaction mixture, are formed during chromatographic work up.

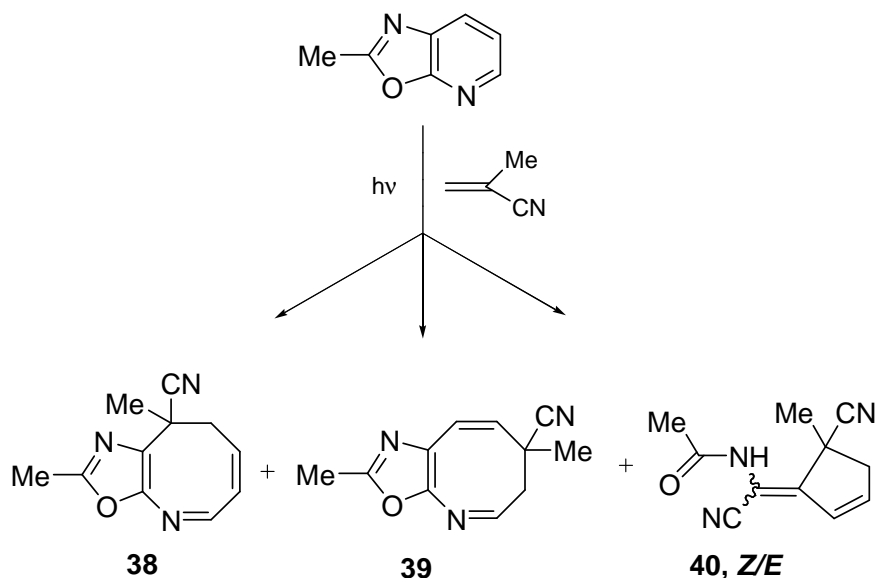

Scheme 17

A possible rationale for the fulvenes formation is reported in Scheme 18. In this case, steric hindrance prevents further cycloaddition of acrylonitrile on the cyclobutapyridine **41**, which rearranges to the oxazoloazocine **42**, unstable on silica gel, to finally give the fulvenes **40**.

A confirm of this mechanism was obtained by trapping the intermediate **41** by addition of acrylonitrile to give the stable Diels-Alder adduct **43**, instead of the fulvenes **40**.^{28b}

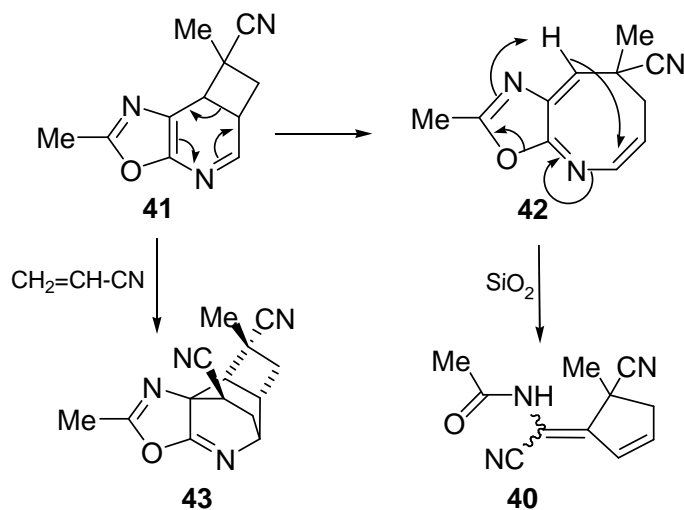

A significantly different result was obtained by irradiation of the same oxazopyridine in the presence of ethyl vinyl ether, an electron rich alkene (Scheme 19). In fact, whereas formation of the ethoxy oxazoloazocines **44** and **46** is expected on the basis of the previously reported mechanism (Scheme 15), ring opened products **45**, **47** and pyrrolopyridine **48** were also obtained (Scheme 19). The latter compound, absent in the photochemical reaction mixture, is formed during chromatographic separation.^{28b}

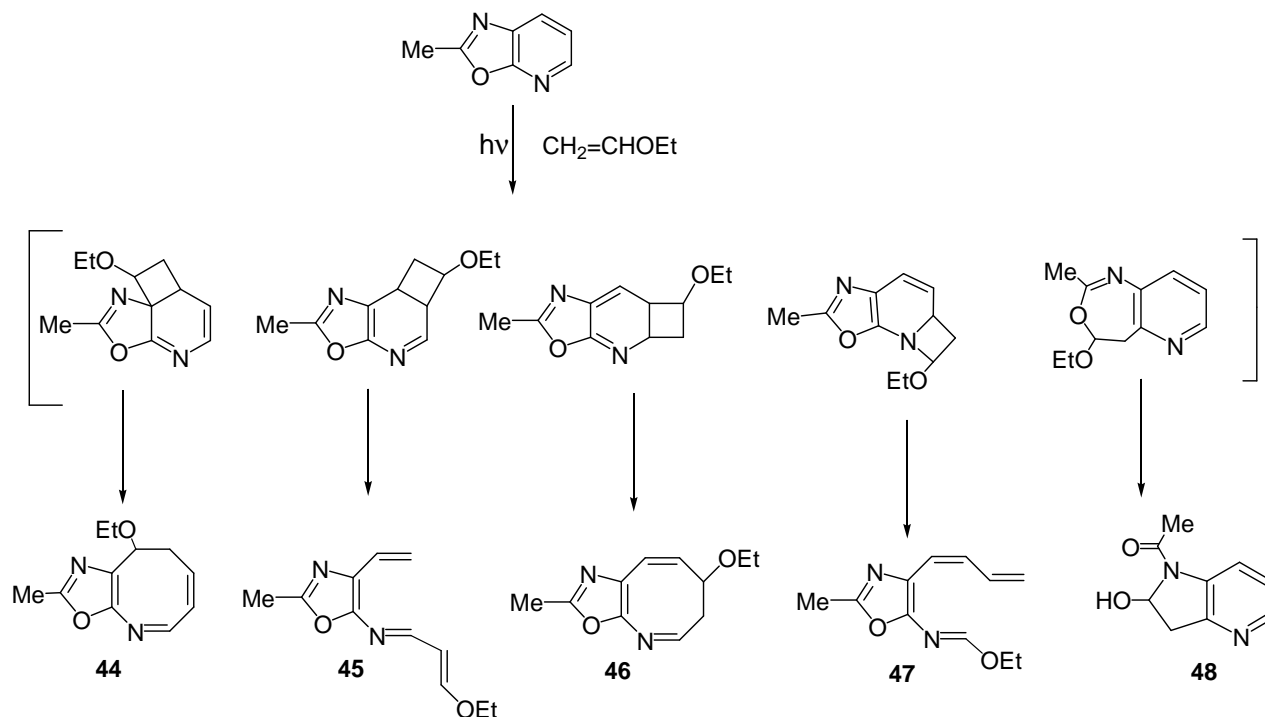

Compound **48** can be accounted on the basis of vinyl ether photoaddition on 1,7a bond with formation of a pyridooxazine which rearranges during chromatographic separation.^{28b} Photoreaction of the same

oxazolopyridine in the presence of furan selectively gives a 2-furylpyridin-3-acetamide through an analogous addition of the electron rich heterocyclic system on the 1,7a-bond followed by spontaneous rearrangement of the seven membered ring (Scheme 20).

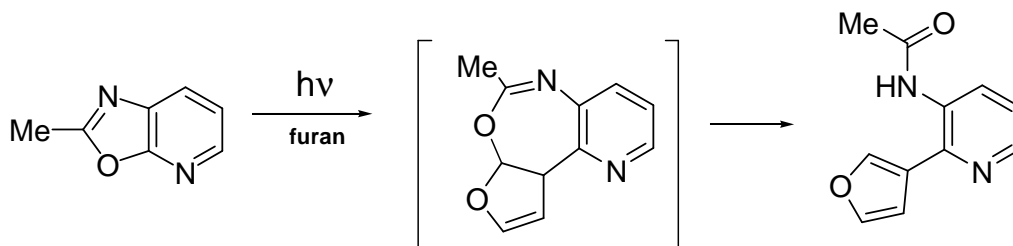

Scheme 20

3.3. Isoxazolopyridine reactivity

Both thermal and photochemical activations of this type of systems can be used. Quite different results are obtained.

3.3.1. Thermal reactivity

Fusion of an isoxazole with a pyridine ring strongly increases chlorine mobility towards nucleophilic substitution as a consequence of negative charge delocalization in intermediate σ -complexes. Kinetic measurements of methoxydechlorination rates in dichloro- or chloroisoxazolopyridines **49-51** ($R, R_1=Cl$ or $R/R_1=Cl, H$) indicate a maximum effect for 4-position of compounds **50** and **51** (Scheme 21).²⁹

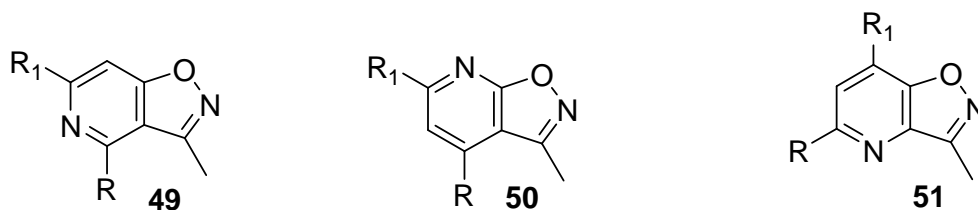

Scheme 21

High reactivity of the chlorine atoms allows their substitution with a phenoxide ion yielding aryl ethers **52** of potential activity as antioxidant agents. Molecular diversity of these derivatives can be increased through photochemical activation. As a first event, photo-Fries rearrangement of compound **52** gives the corresponding hydroquinones **53** (Scheme 22). Afterwards, the corresponding oxazolopyridines **54** are obtained by further irradiation of these compounds through the well known five membered ring rearrangement.³⁰

Interesting cage molecules **55** and **56** belonging to the family of heteracalixarenes can be prepared by reaction of fluoroglucinol with 4,6-dichloroisoxazolo[4,5-*c*]pyridine in the presence of a base (Scheme 23). X-ray structure of **56** confirmed the high symmetry of this compound (Figure 8). One third of the atoms constitute the asymmetric unit, while the remaining others are generated by symmetry. It causes the two phenyl rings to be parallel and eclipsed each other with a distance between their centroids of 4.437(1)Å. The three nitrogen atoms of the pyridine moieties, that may act as possible nucleophilic sites for the interactions

with included ligands, point into the cavity in a trigonal planar array with N...N distances equal to 4.81(1)Å. The three methyl groups are *cis*-oriented.

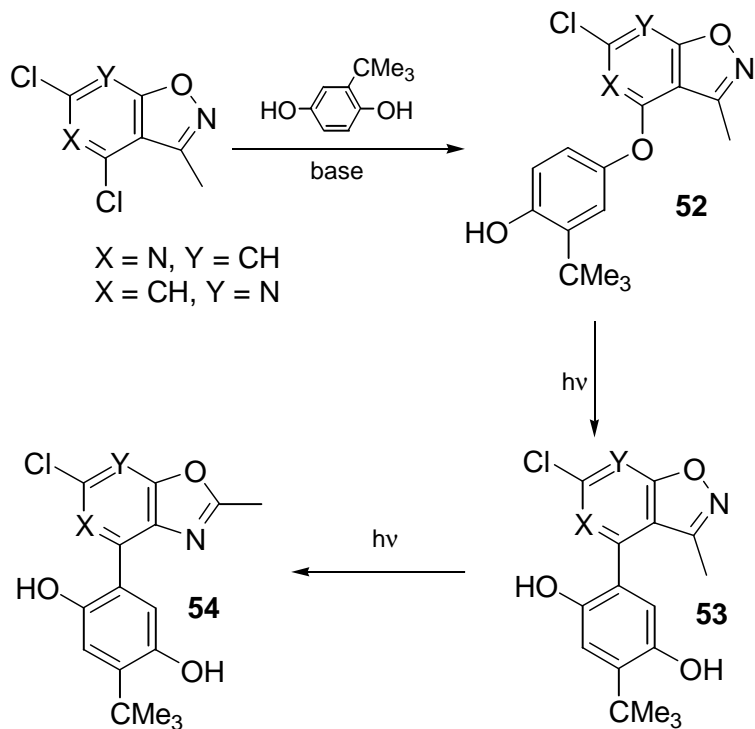

Scheme 22

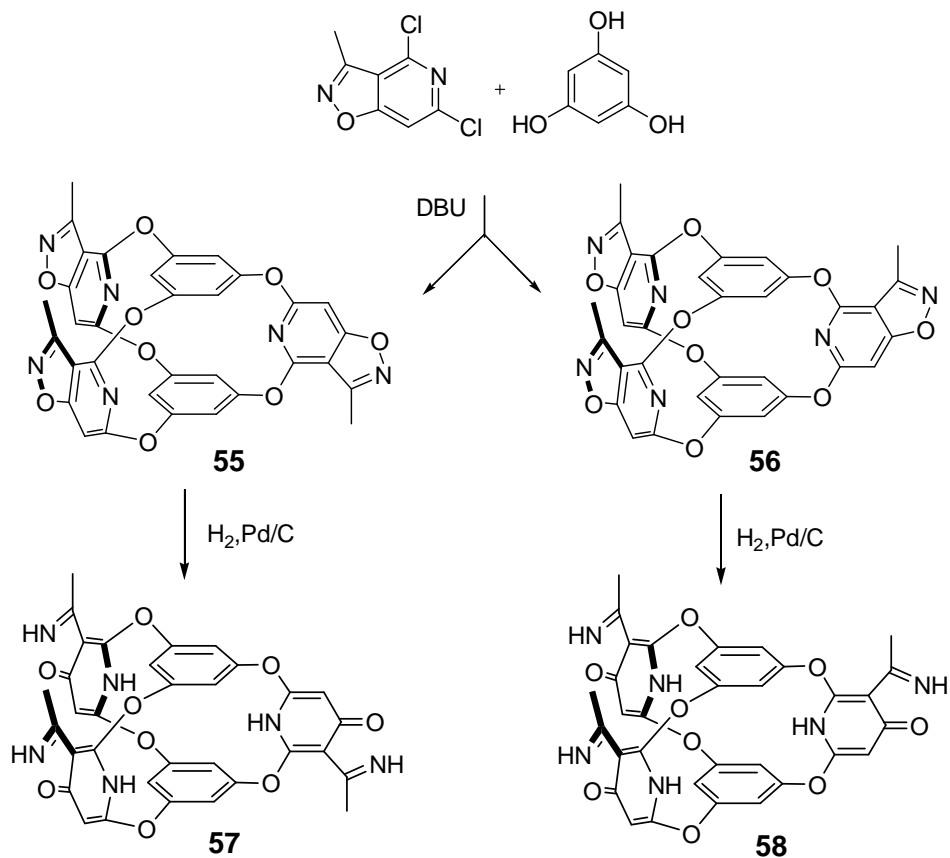

Scheme 23

Density functional theory calculations [B3LYP/6-31g(d,p)] have determined almost the same value of energy for **55** and **56**, suggesting that the alternate orientation of the methylisoxazolo moiety does not influence the stability of the entire molecule.³²

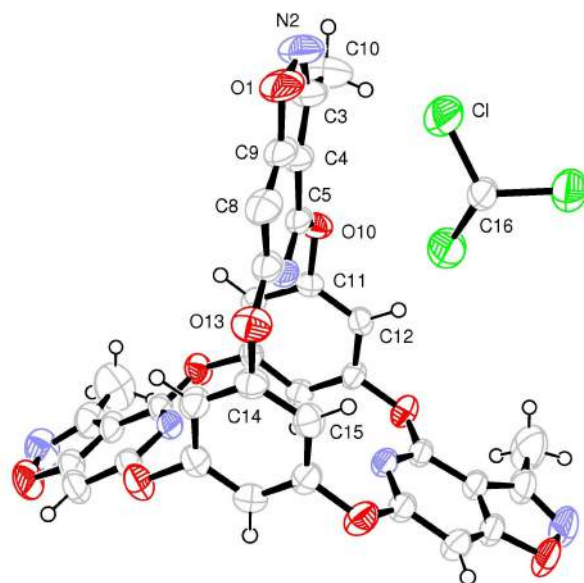

Figure 8. Crystal structure of heteracalixarene **56**×CHCl₃. Ellipsoids enclose 50% probability. The site-occupation factor for the reported chloroform molecule is 0.55(4).

Owing to their scarce polarity, both compounds **55** and **56** do not give any ESI-MS signal, neither as positive nor as negative ions. On the other hand, they can be ionized as protonated molecules by atmospheric pressure chemical ionization that produces intense ions suitable for MS/MS experiments for structural characterization. The atmospheric pressure chemical ionization (APCI) MS/MS spectrum obtained by selecting [**55**+H]⁺ as precursor ion is reported in Figure 9.

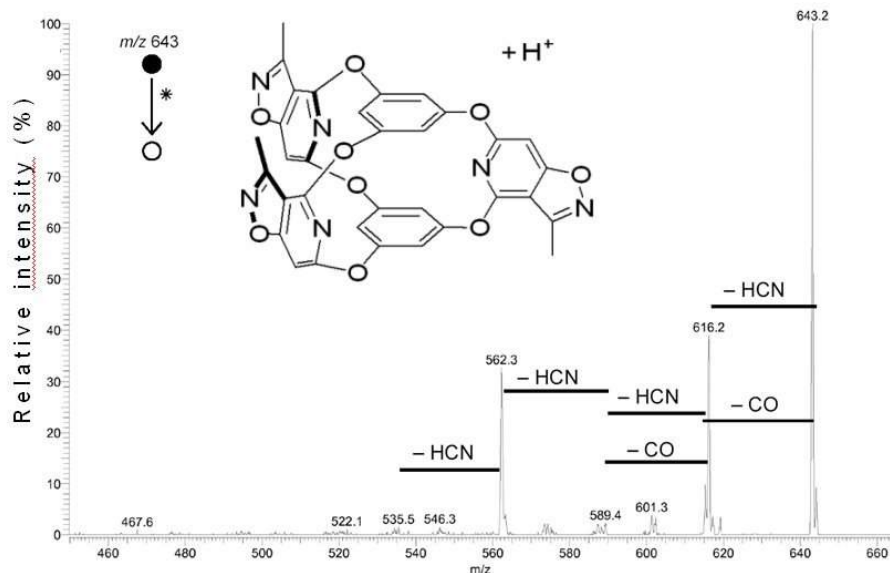
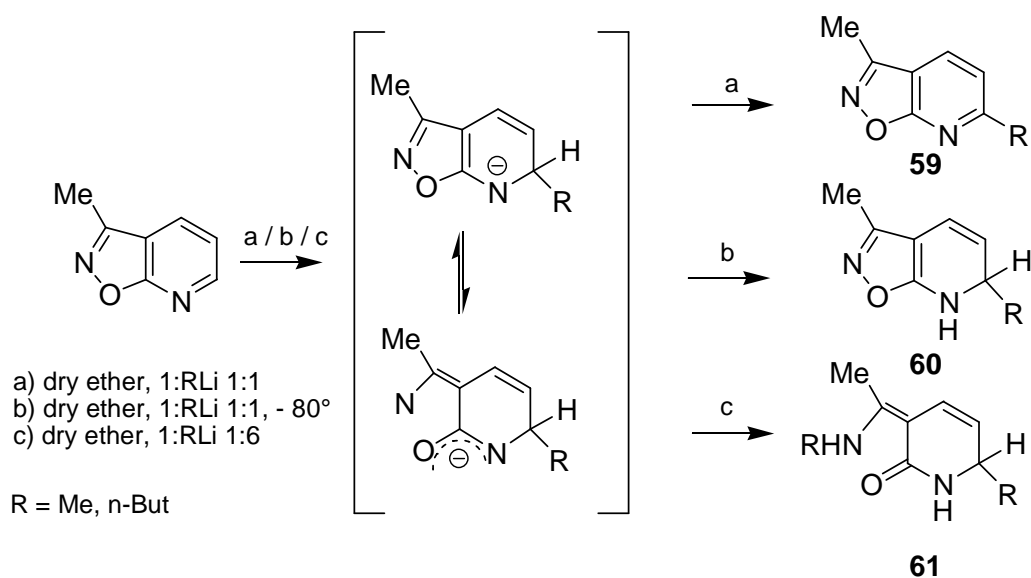

Figure 9. APCI MS/MS spectrum of [**55**+H]⁺ (*m/z* 643) selected as precursor ion.

As it is shown, the main gas phase decomposition pathways involve successive losses of HCN and CO, mainly due to the dismantling of the isoxazole moieties. It is noteworthy that, after one electron removal, neither radical cations of methylisoxazolopyridines²³ nor of benzisoxazoles³¹ show elimination of HCN. In the present case, both the effect of protonation and the linkage of the isoxazolopyridine moiety in the calix assembly play crucial roles in driving gas phase decompositions.

The oxabicyclocalyxarenes **55** and **56** obtained by this way are selective complexing agents for silver or nickel cations, as shown by electrospray measurements. Five ring system of these compounds is easily modified by hydrogenation to give the corresponding pyridones **57** and **58**.³²

Very strong nucleophiles are able to react also with non halogenated isoxazolopyridines. Thus, as reported in Scheme 24, alkyl lithium attack on 6 position of 3-methylisoxazolo[4,5-*c*]pyridine gives, according to the reaction conditions, compounds **59–61**.



Scheme 24

Electrophilic reagents selectively attack pyridine nitrogen as it occurs in the borane reaction on isoxazolo[4,5-*c*]pyridine **62** (R=H) yielding the intermediate complex **63** and, on further borane addition, the tetrahydropyridine **64** (Scheme 25).³³

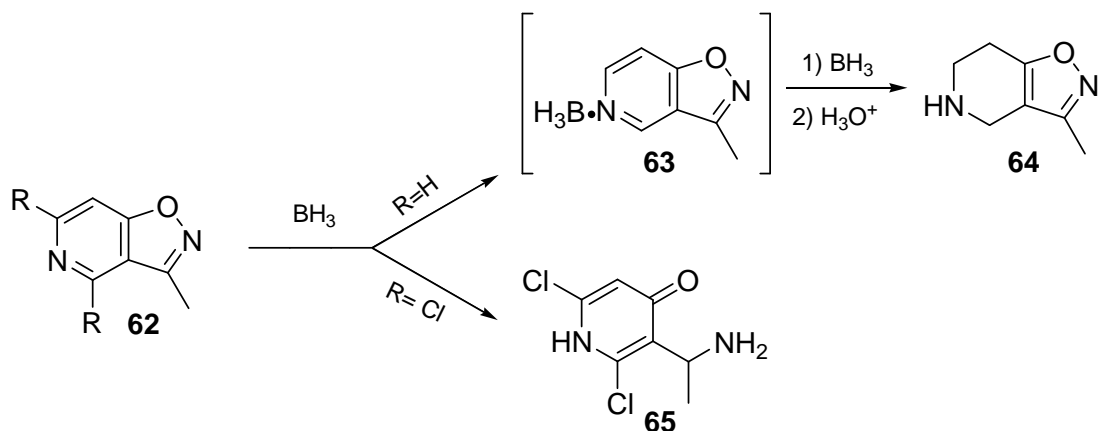

Scheme 25

On the other hand, the attack can be directed to the five membered ring nitrogen as a consequence of steric and electronic factors. In fact, dichloroisoxazopyridine **62** (R=Cl) with the same reagent gives the aminoethylpyridone **65** (Scheme 25).

With reference to the general behaviour of isoxazopyridine systems outlined in Scheme 8, many synthetically useful strategies can be accounted. Thus, introduction of a suitable substituent (ZNH₂) on 4-position followed by ring opening of isoxazolo[4,5-*c*]-pyridines with molybdenum hexacarbonyl in refluxing methanol is an efficient and versatile procedure for the preparation of a library of functionalized pyridocondensed heterocycles, containing from five to eight atoms in the ring (Scheme 26).

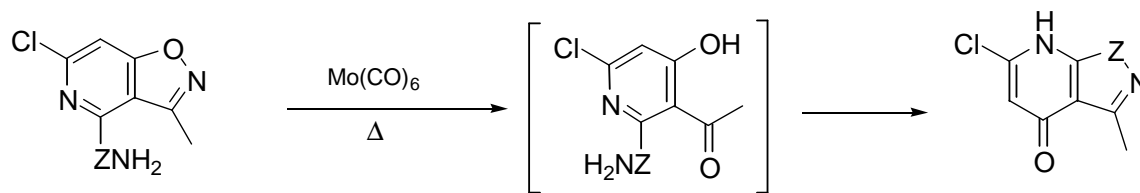

Scheme 26

Following this synthetic protocol, the pyrido-condensed heterocycles **66–72** can be prepared (Scheme 27).^{34a,b}

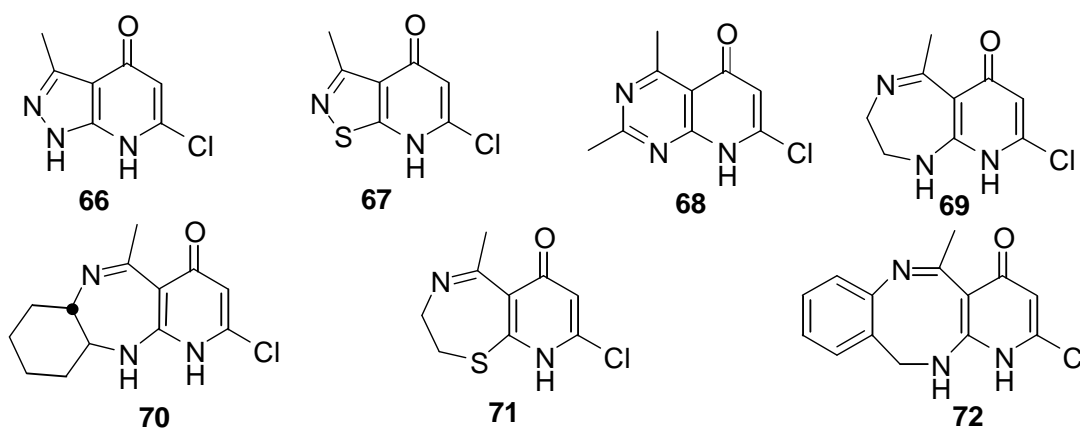

Scheme 27

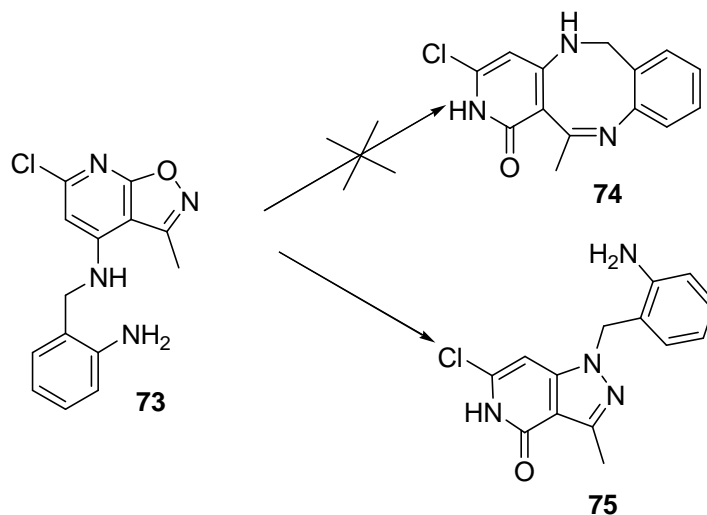

Scheme 28

This procedure is of general application: molybdenum hexacarbonyl opening of the corresponding [5,4-*b*] derivatives generally gives similar results, with the exception of the *o*-aminobenzylamino-isoxazolopyridine **73** which, instead of the pyridodiazocine **74**, gives the corresponding *N*-benzylpyrazolopyridine **75** (Scheme 28). Formation of this compound involves the attack of benzylamine nitrogen on a nitrene like intermediate, as previously outlined in Scheme 8.^{34c}

A different pathway is followed in the case of 4,6-diazo isoxazolopyridine **76** which, by reduction of both five membered ring and the functional groups, followed by azido-tetrazole tautomerism, gives the diamine **77** (Scheme 29).^{34d}

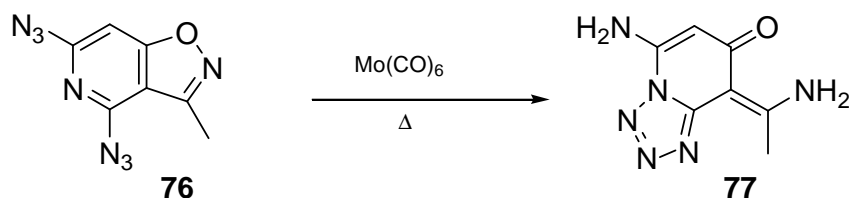

Scheme 29

3.3.2. Photochemical reactions

Some years ago, it was reported the photochemical rearrangement of isoxazolo[5,4-*b*] pyridines to the corresponding oxazolo[5,4-*b*] analogues.³⁵ Afterwards, further insight into this reaction has been obtained by flash-photolysis and trapping experiments that showed the presence of two kind of intermediates, the ketenimine **78** and the spiroazirine **79** (Scheme 30).³⁶ The former can add a suitable nucleophile to give the stable pyridone **80**, whereas the latter gives the corresponding oxazolo-pyridine. This behaviour stimulates the searching for synthetically useful photochemical rearrangements of 4-substituted isoxazolopyridines having a suitable group for intramolecular attack on the above reported intermediates. The results of this type of investigations are depicted in the Scheme 31.

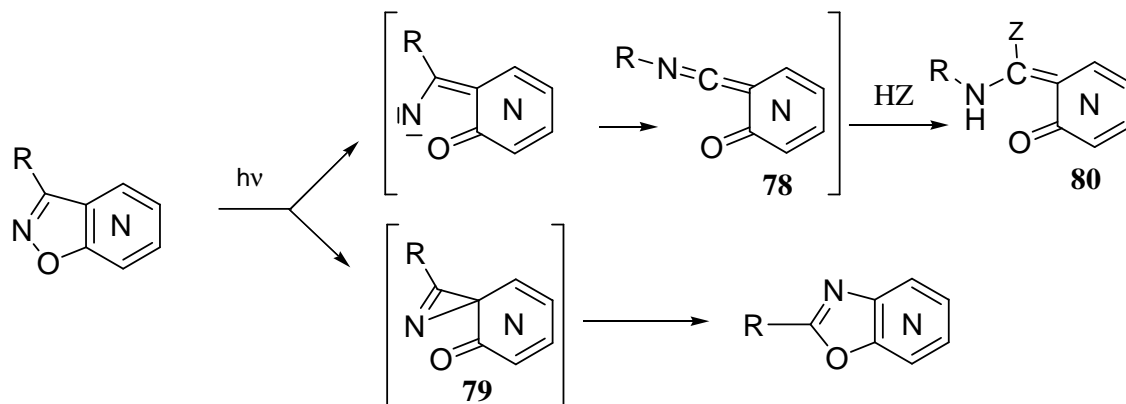

Scheme 30

The photochemical transformation of the starting isoxazolopyridine into compounds **81**, **82**, **84** and **86** is well accounted on the basis of the corresponding nitrene/ketenimine intermediates, whereas a spiroazirine is involved in the formation of compounds **83**, **85** and **87**.³⁷

It is worth to note the wide range of pyridine derivatives which can be obtained following this simple synthetic approach.

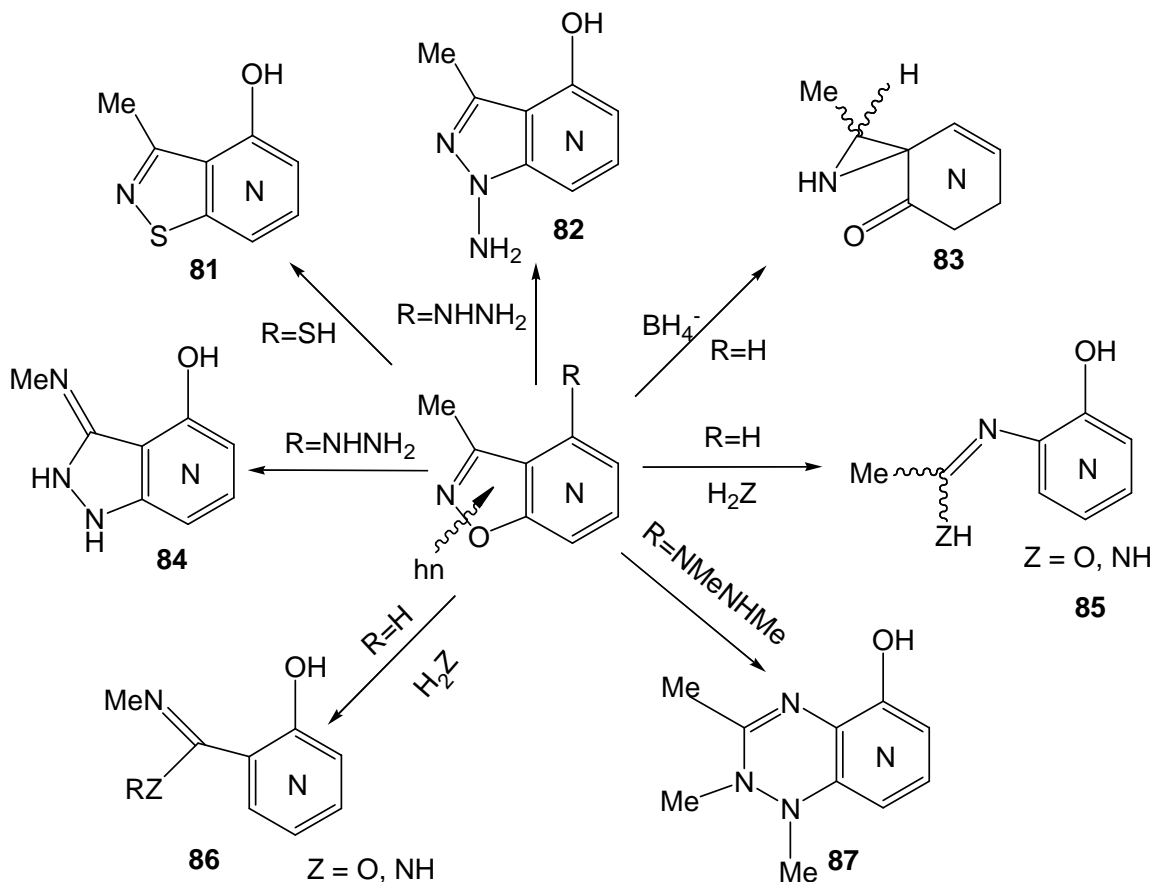

Scheme 31

4. Conclusions

Preparation, properties and reactivity of (is)oxazolopyridine derivatives have been presented.

Derivatization/cyclization of suitable acyclic compounds can be used for their preparation. (Is)oxazolopyridine are useful synthons for accessing different classes of heterocyclic species while their ring dismantling may yield to cyclic and acyclic organic compounds. They can undergo thermal and photochemical modifications of their nuclei as well as substitution and addition reactions. Different methods, and in particular nuclear magnetic resonance, X-ray crystallography and mass spectrometry, can be efficiently used for their structural characterization.

Acknowledgments

The Authors thank the financial support by the University of Siena as a PAR Project 2006 and MIUR for PRIN Project 2006.

References

- Denonne, F.; Celanire, S.; Provins, L.; Defays, S. *PCT Int. Appl.* **2008**, 164pp. CODEN: PIXXD2 WO 2008012010 A1 20080131.
- (a) Nunes, J. J.; Milne, J.; Bemis, J.; Xie, R.; Vu, C. B.; Ng, P. Y.; Disch, J. S.; Salzmann, T.; Armistead, D. *PCT Int. Appl.* **2007**, 579pp. CODEN: PIXXD2 WO 2007019417 A1 20070215 CAN 146:274369 AN 2007:171908 CAPLUS. (b) Binggeli, A.; Christ, A. D.; Green, L.; Gideon, G.; Guba, W.; Maerki, H.-P.; Martin, R. E.; Mohr, P. *PCT Int. Appl.*, **2006**, 224pp. CODEN: PIXXD2 WO 2006094682 A1 20060914.

3. (a) Hardouin, C.; Kelso, M. J.; Romero, F. A.; Rayl, T. J.; Leung, D.; Hwang, I.; Cravatt, B. F.; Boger, D. L. *J. Med. Chem.* **2007**, *50*, 3359–3368. (b) Pichota, A.; Duraiswamy, J.; Yin, Z.; Keller, T. H.; Schreiber, M. *PCT Int. Appl.* **2007**, 124pp. CODEN: PIXXD2 WO 2007077186 A1 20070712. (c) Inoue, T.; Tojo, T.; Morita, M.; Nakajima, Y.; Hatanaka, K.; Shirakami, S.; Sasaki, H.; Tanaka, A.; Takahashi, F.; Mukoyoshi, K.; Higashi, Y.; Okimoto, A.; Hondo, T.; Sawada, H. *PCT Int. Appl.* **2007**, 260pp. CODEN: PIXXD2 WO 2007007919 A2 20070118 CAN 146:184461 AN 200761234. (d) Zoller, G.; Petry, S.; Mueller, G.; Tennagels, N. (Sanofi-Aventis, Fr.) *PCT Int. Appl.* **2007**, 72pp. CODEN: PIXXD2 WO 2007110216 A1 20071004 Application: WO 2007-EP2649 20070326. Priority: DE 2006-102006014688 20060328. CAN 147:427332 AN 2007:1115398. (e) Almansa Rosales, C.; Virgili Bernado, M.; Grima Poveda, P. M. *PCT Int. Appl.* **2006**, 80 pp. (f) Deng, J. Z.; McMasters, D. R.; Rabbat, P. M. A.; Williams, P. D.; Coburn, C. A.; Yan, Y.; Kuo, L. C.; Lewis, S. D.; Lucas, B. J.; Krueger, J. A.; Strulovici, B.; Vacca, J. P.; Lyle, T. A.; Burgey, C. S. *Bioorg. Med. Chem. Lett.* **2005**, *15*, 4411–4416.
4. (a) Wynne, G. M.; Wren, S. P.; Johnson, P. D.; Price, D.; De Moor, O.; Nugent, G.; Tinsley, J. M.; Storer, R.; Mulvaney, A.; Pye, R. J.; Dorgan, C. R. *PCT Int. Appl.* **2007**, 170pp. CODEN: PIXXD2 WO 2007091106 A2 20070816 CAN 147:235175 AN 2007:906796 CAPLUS. (b) Ali, A.; Hunt, J. A.; Kallashi, F.; Kowalchick, J. E.; Kim, D.; Smith, C. J.; Sinclair, P. J.; Sweis, R. F.; Taylor, G. E.; Thompson, C. F.; Chen, L.; Quraishi, N. *PCT Int. Appl.* **2007**, 294pp. CODEN: PIXXD2 WO 2007070173 A2 20070621. (c) Belyankin, A. V.; Duplantier, A. J.; Zhang, L.; O'Donnell, C. J.; Rogers, B. N.; Vincent, L. A.; Sviridov, S. I. *PCT Int. Appl.* **2006**, 60 pp. CODEN: PIXXD2 WO 2006051410 A1 20060518. (d) Wilde, R.; Welch, E.; Karp, G. M. *PCT Int. Appl.* **2006**, 163 pp. CODEN: PIXXD2 WO 2006044503 A2 20060427.
5. (a) Gomez, B.; Likhanova, N. V.; Dominguez-Aguilar, M. A.; Martinez-Palou, R.; Vela, A.; Gazquez, J. L. *J. Phys. Chem. B* **2006**, *110*, 8928–8934. (b) Diudea, M. V.; Parv, B. *Croat. Chem. Acta* **2006**, *79*, 483–488. (c) Temiz-Arpaci, O.; Tekiner-Gulbas, B.; Yildiz, I.; Aki-Sener, E.; Yalcin, I. *Bioorg. Med. Chem.* **2005**, *13*, 6354–6359.
6. (a) Orui, H.; Senoo, A.; Kosuga, T.; Watabe, D. *Jpn. Kokai Tokkyo Koho* **2008**, 37pp. CODEN: JKXXAF JP 2008127315 A 20080605. Application: JP 2006-312824 20061120. Priority: AN 2008:666507. (b) Deligeorgiev, T. G.; Gadjev, N. I.; Vasilev, A. A.; Maximova, V. A.; Timcheva, I. I.; Katerinopoulos, H. E.; Tsikalas, G. K. *Dyes Pigments* **2007**, *75*, 466–473. (c) Nonaka, M.; Tanaka, M.; Fujii, A.; Kawahara, M.; Ishizuka, Y. *Jpn. Kokai Tokkyo Koho* **2006**, 26pp. CODEN: JKXXAF JP 2006251327 A 20060921. Application: JP 2005-67322 20050310. Priority: CAN 145:345208 AN 2006:980935. (d) Vasilev, A.; Deligeorgiev, T.; Gadjev, N.; Drexhage, K.-H. *Dyes Pigments* **2005**, *66*, 135–142. (e) Dalwig, J.; Hagen, D.; Huang, T.; Thomas, J.; Yue, S. *PCT Int. Appl.* **2005**, 111 pp. CODEN: PIXXD2 WO 2005056689 A2 20050623.
7. Recent reviews: (a) Smalley, R. K. In *Science of Synthesis*; Schaumann, E., Ed.; Georg Thieme Verlag, Stuttgart: New York, 2002; Vol. 11, pp. 289–335 and 337–382. (b) Boyd, G. V. *ibid.*, 481–492. (c) Rossi, L. *ibid.*; Weinreb, S. M., Ed.; 2003; Vol. 17, pp. 556–557, and references cited therein.
8. Heuser, S.; Keenan, M.; Weichert, A. G. *Tetrahedron Lett.* **2005**, *46*, 9001–9004.
9. (a) Myllymaeki, M. J.; Koskinen, A. M. P. *Tetrahedron Lett.* **2007**, *48*, 2295–2298. (b) Garnier, E.; Blanchard, S.; Rodriguez, I.; Jarry, C.; Leger, J. M.; Caubere, P.; Guillaumet, G. *Synthesis* **2003**, 2033–2040.
10. Martinez-Palou, R.; Zepeda, L. G.; Hoepfl, H.; Montoya, A.; Guzman-Lucero, D. J.; Guzman, J. *Mol. Divers.* **2005**, *9*, 361–369.
11. Likhanova, N. V.; Veloz, M. A.; Hopfl, H.; Matias, D. J.; Reyes-Cruz, V. E.; Olivares, O.; Martinez-Palou, R. *J. Heterocyclic Chem.* **2007**, *44*, 145–153.
12. Mohammadpoor-Baltork, I.; Khosropour, A. R.; Hojati, S. F. *Monatsh. Chem.* **2007**, *138*, 663–667.
13. Tjosaas, F.; Kjerstad, I. B.; Fiksdahl, A. *J. Heterocyclic Chem.* **2008**, *45*, 559–562.
14. Hintermann, S.; Chiesi, M.; von Krosigk, U.; Mathe, D.; Felber, R.; Hengerer, B. *Bioorg. Med. Chem. Lett.* **2007**, *17*, 193–196.
15. (a) Volochnyuk, D. M.; Pushechnikov, A. O.; Krotko, D. G.; Sibgatulin, D. A.; Kovalyova, S. A.; Tolmachev, A. A. *Synthesis* **2003**, 1531–1540. (b) Ryabukhin, S. V.; Plaskon, A. S.; Volochnyuk, D. M.; Tolmachev, A. A. *Synthesis* **2007**, 1861–1871.

16. Rajanarendar, E.; Srinivas, M.; Ramu, K. *Synthetic Commun.* **2003**, *33*, 3077–3080.
17. Dyllal, L. K.; Maloney, D. W.; Harvey, J. J.; Fulloon, B. E. *Aust. J. Chem.* **1996**, *49*, 761–765.
18. Duffy, K. J.; Tennant, G. *J. Chem. Soc., Chem. Commun.* **1995**, 2457–2459.
19. (a) Chimichi, S.; Tedeschi, P.; Camparini, A.; Ponticelli, F. *Org. Magn. Res.* **1982**, *20*, 141–144. (b) Chimichi, S.; Tedeschi, P.; Nesi, R.; Ponticelli, F. *Magn. Res. Chem.* **1985**, *23*, 86–89.
20. Norman, M. H.; Minick, D. J.; Martin, G. E. *J. Heterocyclic Chem.* **1993**, *30*, 771–779.
21. Gelmi, M. L.; Pocar, D.; Viziano, M.; Destro, R.; Merati, F. *J. Chem. Soc., Perkin Trans. I* **1992**, 701–705.
22. Giorgi, G.; Ponticelli, F. unpublished results.
23. (a) Ponticelli, F.; Giomi, D.; Papaleo, S.; Tedeschi, P. *Org. Mass Spectrom.* **1993**, *28*, 451–454. (b) Giorgi, G.; Ponticelli, F.; Czira, G.; Vekey, K. *J. Am. Soc. Mass Spectrom.* **1995**, *6*, 962–971.
24. (a) Harris, T. D.; Kumler, P. L. *J. Org. Chem.* **1972**, *37*, 1830–1832. (b) Savarino, P.; Viscardi, G.; Carpignano, R.; Barni, E. *J. Heterocyclic Chem.* **1989**, *26*, 77–80. (c) Savarino, P.; Viscardi, G.; Carpignano, R.; Borda, A.; Barni, E. *ibid.*, 289–92.
25. Yamanaka, H.; Niitsuma, S.; Sakai, M.; Sakamoto, T. *Chem. Pharm. Bull.* **1988**, *36*, 168–171.
26. (a) Flouzat, C.; Guillaumet, G. *J. Heterocyclic Chem.* **1991**, *28*, 899–906. (b) Flouzat, C.; Savelon, L.; Guillaumet, G. *Synthesis* **1992**, 842–844.
27. Zhuravlev, F. A. *Tetrahedron Lett.* **2006**, *47*, 2929–2932.
28. (a) Donati, D.; Fusi, S.; Ponticelli, F. *Tetrahedron Lett.* **1996**, *37*, 5783–5786. (b) Donati, D.; Fusi, S.; Ponticelli, F. *Eur. J. Org. Chem.* **2002**, 4211–4216.
29. (a) Adembri, G.; Camparini, A.; Ponticelli, F.; Tedeschi, P. *J. Heterocyclic Chem.* **1979**, *16*, 49–51. (b) Camparini, A.; Ponticelli, F.; Tedeschi, P. *J. Chem. Soc., Perkin Trans. I* **1982**, 2391–2394.
30. Ferrini, S.; Fusi, S.; Ponticelli, F.; Valoti, M. *J. Pharm. Pharmacol.* **2007**, *59*, 829–835.
31. Giorgi, G.; Salvini, L.; Ponticelli, F. *J. Am. Soc. Mass Spectrom.* **2004**, *15*, 1005–1013.
32. Ferrini, S.; Fusi, S.; Giorgi, G.; Ponticelli, F. *Eur. J. Org. Chem.* **2008**, 5407–5413.
33. Adembri, G.; Camparini, A.; Ponticelli, F.; Tedeschi, P. *Tetrahedron Lett.* **1982**, *23*, 4375–4378.
34. (a) Chimichi, S.; Nesi, R.; Ponticelli, F.; Tedeschi, P. *J. Chem. Soc., Perkin Trans. I* **1990**, 1477–1480. (b) Donati, D.; Ferrini, S.; Fusi, S.; Ponticelli, F. *Synthesis* **2003**, 2518–2524. (c) Donati, D.; Ferrini, S.; Fusi, S.; Ponticelli, F. *J. Heterocyclic Chem.* **2004**, *41*, 761–766. (d) Donati, D.; Fusi, S.; Ponticelli, F. *J. Chem. Res. (S)* **1997**, 170–171.
35. Skoetsch, C.; Breitmaier, E. *Chem. Ber.* **1979**, *112*, 3282–3285.
36. Donati, D.; Ponticelli, F.; Bicchi, P.; Meucci, M. *J. Phys. Chem.* **1990**, *94*, 5271–5274.
37. (a) Adembri, G.; Camparini, A.; Donati, D.; Ponticelli, F.; Tedeschi, P. *Tetrahedron Lett.* **1981**, *22*, 2121–2124. (b) Donati, D.; Fusi, S.; Ponticelli, F.; Tedeschi, P. *Heterocycles* **1988**, *27*, 1899–1905. (c) Chimichi, S.; Nesi, R.; Ponticelli, F.; Tedeschi, P. *J. Chem. Soc., Perkin Trans. I* **1990**, 1477–1480. (d) Donati, D.; Fusi, S.; Ponticelli, F. *Tetrahedron Lett.* **2002**, *43*, 9527–9530.

NEW METHODS FOR THE ASYMMETRIC SYNTHESIS OF PIPERIDINES AND PYRROLIDINES: CHIRAL AUXILIARIES AND ASYMMETRIC ORGANOCATALYSIS

Jose L. Vicario,* Dolores Badía,* Luisa Carrillo, Nerea Ruiz and Efraim Reyes

Departamento de Química Orgánica II, Universidad del País Vasco/Euskal Herriko Unibertsitatea,
P.O. Box 644, E-48080 Bilbao, Spain (e-mail: joseluis.vicario@ehu.es; dolores.badia@ehu.es)

Abstract. *The asymmetric synthesis of substituted piperidines and pyrrolidines is a major field of research in organic chemistry. Our group has developed efficient protocols for the asymmetric synthesis of many of these interesting heterocycles by two conceptually different approaches such as the chiral auxiliary methodology and asymmetric organocatalysis. In this context, we have recently developed complementary protocols for the stereoselective synthesis of 2-alkylpiperidines, including the naturally occurring (R)-pipercoline and (S)-coniine, and an α -hydroxyalkyl-substituted piperidine like (-)- β -conhydrine using the commercially available and cheap aminoalcohol (S,S)-(+)-pseudoephedrine as chiral auxiliary. Alternatively, the access to complex and highly substituted pyrrolidines has been achieved by organocatalytic stereocontrolled transformations applying an enantioselective [3+2] cycloaddition reaction using azomethine ylides as dipoles or, alternatively, using an asymmetric Michael reaction between aldehydes and β -nitroacrolein dimethylacetal as key step. Both methodologies have been successfully set up in our laboratories very recently.*

Contents

1. Introduction
 2. Asymmetric synthesis of piperidine alkaloids using (S,S)-(+)-pseudoephedrine as chiral auxiliary
 - 2.1. A general and stereodivergent method for the asymmetric synthesis of 2-alkylpiperidine alkaloids
 - 2.2. Asymmetric synthesis of (-)- β -conhydrine
 3. Organocatalytic asymmetric synthesis of pyrrolidines
 - 3.1. Organocatalytic enantioselective [3+2] cycloaddition of azomethine ylides and α,β -unsaturated aldehydes
 - 3.2. Organocatalytic Michael reaction of aldehydes and nitroacrolein dimethylacetal. Synthesis of 3,4-disubstituted and 2,3,4-trisubstituted pyrrolidines
 4. Concluding remarks
- Acknowledgments
References

1. Introduction

The piperidine and pyrrolidine heterocyclic rings are found as key structural constituents in many natural products and pharmaceutical compounds, attracting considerable attention, especially due to their broad and important biological activities. As a consequence, the development of new methods for the synthesis of pyrrolidine¹ or piperidine-based² compounds is of remarkable importance. Moreover, when chiral derivatives have to be prepared, the development of stereocontrolled protocols for their synthesis is a

key field of research for the organic chemists and, therefore, many research groups worldwide have carried out intensive research focussed in the development of new more efficient and flexible methodologies for the preparation of these important five- and six-membered *N*-heterocycles in an enantioenriched way. In this context, although many reports have been directed to the use of chiral pool reagents as starting materials,^{1,2} the *de novo* asymmetric synthesis of pyrrolidines and piperidines has attracted a higher level of attention due to the wider applicability and efficiency attained by many of the procedures developed up to date.

Two general methodologies can be applied when the stereocontrolled synthesis of piperidines and pyrrolidines has to be carried out starting from achiral starting materials, namely the use of chiral auxiliaries or, alternatively, carrying out the reaction in the presence of a chiral catalyst. These two methodologies can be in fact considered as complementary, choosing one or the other depending on the desired synthetic objective. In this way, compared to catalytic processes, chiral auxiliary-controlled asymmetric reactions can generally be scaled-up easier and are not as sensitive as the related catalytic asymmetric processes to minor perturbations such as impurities present in starting materials, solvents or reagents. Moreover, in the case that the reaction is not fully stereoselective, the diastereoisomeric nature of the by-products allows an easier purification and isolation of the major isomer from the product mixture. However, the chiral auxiliary-based approach shows important drawbacks with respect to the use of catalytic processes. On one hand, it requires two extra synthetic steps for attaching the chiral auxiliary to the starting material and for its removal from the final adduct. On the other hand, the requirement of stoichiometric amounts of the primary chirality source can not compete with the low amount of chiral inductor required in the catalytic asymmetric transformations, although in some cases this problem can be circumvented by developing effective protocols for recovering and recycling the chiral auxiliary after its removal.

Taking these facts into account, our group has explored different approaches to the synthesis of several piperidine natural alkaloids and highly functionalized polysubstituted pyrrolidines employing both types of methodologies. In particular, we have described the synthesis of (*R*)-*pipecoline* and (*S*)-*coniine* using the commercially available and cheap reagent (*S,S*)-pseudoephedrine as chiral auxiliary^{3,4} and we have synthesized a related piperidine alkaloid such as *conhydrine* using also this aminoalcohol. Alternatively, we have also devised new procedures for the asymmetric synthesis of highly substituted pyrrolidine derivatives employing enantioselective organocatalytic transformations developed in our laboratories.

2. Asymmetric synthesis of piperidine alkaloids using (*S,S*)-(+)-pseudoephedrine as chiral auxiliary

We have developed an efficient protocol for the asymmetric synthesis of (*R*)-*pipecoline* and (*S*)-*coniine* together with other non natural 2-alkylpiperidines using a novel stereodivergent approach mainly relying on a stereocontrolled aza-Michael reaction using the commercially available and cheap reagent (*S,S*)-(+)-pseudoephedrine as chiral auxiliary. We have also carried out the synthesis of the β -isomer of *conhydrine*, a different piperidine alkaloid, in this case by exploiting the 1,2-addition reaction of Grignard reagents to α -iminoamides incorporating the same reagent as chiral auxiliary.

2.1. A general and stereodivergent method for the asymmetric synthesis of 2-alkylpiperidine alkaloids

As it has been previously mentioned, the piperidine ring is an ubiquitous structural feature shared by many natural products and therapeutics. In particular, simple 2-alkyl substituted piperidines play an important role as key targets for the pharmaceutical chemistry because they exhibit an extensive range of

biological activities. For example, *pipicoline* and *coniine* (Figure 1) are alkaloids found as constituents of the poisonous hemlock (*Conium Maculatum L.*) and they have been considered as excellent targets for the demonstration of the performance achieved by the new methodologies developed for the asymmetric synthesis of piperidines.

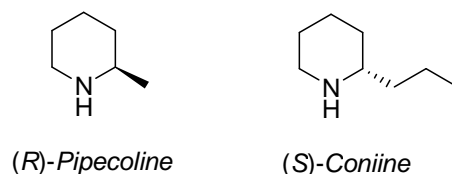
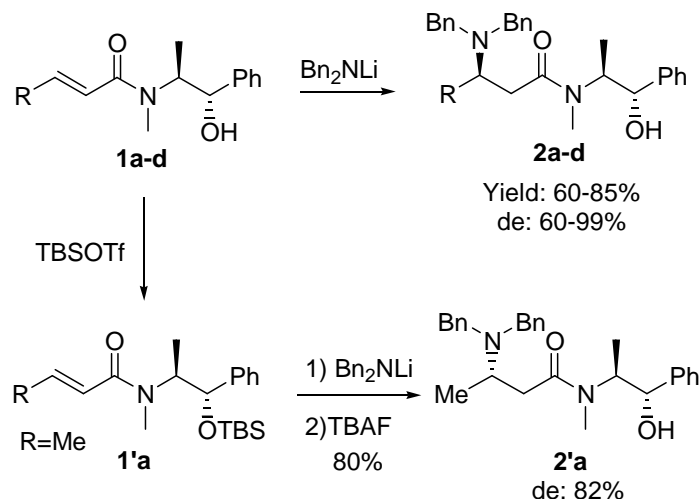

Figure 1

As it can be seen in the two examples shown in Figure 1, it is very often found in naturally occurring 2-alkylpiperidines that the configuration of the stereogenic centre present at the heterocycle moiety varies across the different members of this family of compounds. In this context, when planning the asymmetric synthesis of any member of this family using many of the already reported procedures, a careful election of the chiral starting material, auxiliary, ligand or catalyst employed in the generation of this stereocentre is necessary in order to prepare the final compound with the right configuration. This means that if one wants to employ a general and modular route for the synthesis of a wide number of 2-alkylpiperidines both enantiomers of this chiral starting material, auxiliary, ligand or catalyst have to be commercially available.

As a consequence of this, the design of enantiodivergent protocols, which allow the stereoselective preparation of a chiral compound in any desired configuration using the same chirality source, is a challenging task for the synthetic organic chemists. In this context, we have recently shown that *(S,S)*-(+)-pseudoephedrine can play the role as an excellent chiral auxiliary in asymmetric aza-Michael reactions.⁵ More interestingly, a simple modification of its structure, such as the derivatization of the hydroxy group as a bulky trialkylsilyl ether, leads to the formation of the corresponding aza-Michael adduct with the opposite configuration at the newly created stereogenic centre, if compared with the same reaction using the unmodified chiral auxiliary, therefore presenting a stereodivergent protocol for the asymmetric synthesis of β -amino carbonyl compounds (Scheme 1).⁶



Scheme 1

Therefore, using these *N*-protected- β -amino amides derived from (*S,S*)-(+)-pseudoephedrine which were prepared through our aza-Michael reaction protocol, we planned the synthesis of chiral enantioenriched 2-alkylpiperidines according to the retrosynthetic approach shown in Scheme 2.⁷ The disconnection of the C6-N bond of the piperidine ring would lead to a δ -amino aldehyde structure, which could be obtained by a chain-elongation process from the corresponding conveniently protected β -aminoaldehyde. This could be hypothetically prepared directly from a chiral nonracemic γ -amino alcohol, the latter being easily accessible from the already mentioned aza-Michael β -amino amide adducts. This strategy would allow us to synthesize two naturally occurring piperidine alkaloids such as (*R*)-pipercoline and (*S*)-coniine and other non natural derivatives. The preparation of these two natural alkaloids with opposite configuration has been approached by applying the stereodivergent procedure shown in Scheme 1 which has also been optimized in our laboratories.

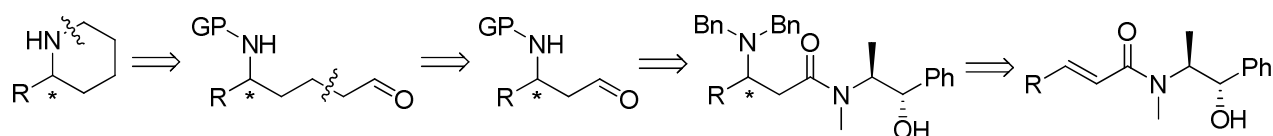

Scheme 2

We started our investigations with the preparation of enantioenriched chiral γ -amino alcohols **4a–d** starting from the corresponding (*S,S*)-(+)-pseudoephedrine derived enamides **1a–d**, as it had been previously described by us (Scheme 3).⁶ The employed protocol involved an aza-Michael reaction with lithium dibenzylamide as the key step regarding the stereocontrolled installation of the stereogenic centre. In this case, different experimental conditions had to be used depending upon the nature of the R alkyl chain introduced at the enamide precursor in order to reach to the highest possible yield and diastereoselectivity (Table 1). Next, we needed to carry out a protecting-group interconversion at the adducts **2a–d** in order to proceed to the removal of the chiral auxiliary by reduction, yielding cleanly the required γ -amino alcohols **4a–d**. We have already demonstrated that this protecting-group interconversion strategy was absolutely necessary in order to avoid epimerization at the stereogenic centre during this reduction process.

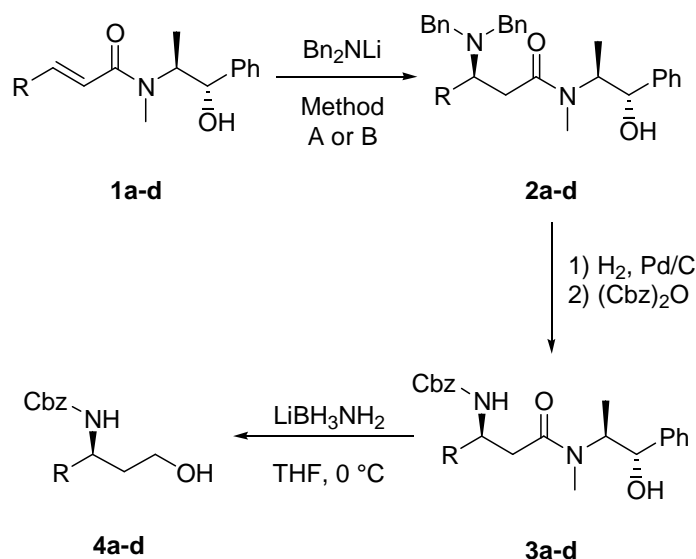

Scheme 3

Table 1. Asymmetric synthesis of γ -aminoalcohols **4a–d**.

Entry	R	Prod.	Conditions ^a	Yield ^b (%)	dr ^c	Prod.	Yield ^b (%)	Prod.	Yield ^b (%)	ee ^d (%)
1	Me	2a	A	85	>99:1	3a	70	4a	85	98
2	Et	2b	B	88	94:6	3b	75	4b	76	88
3	<i>t</i> -Bu	2c	C	50	>99:1	3c	64	4c	72	98
4	Ph	2d	A	15	98:2	3d	43	4d	90 ^e	98

^aMethod A: Bn₂NLi, toluene, -90 °C. Method B: Bn₂NLi/TMEDA (1:1), toluene, -90 °C. Method C: Bn₂NLi/CuI/TMEDA (2:1:2), THF, -90 °C. ^bYield of pure product after flash column chromatography purification. ^cDetermined by HPLC (Chiralcel OD column, UV detector, hexanes/*iso*-propanol 95:5, flow rate: 1.00mL/min). ^dDetermined by HPLC (Chiralcel OJ column, UV detector, hexanes/*iso*-propanol 99:1, flow rate: 1.00mL/min). ^eBased on recovered **3d**.

We next proceeded to carry out the oxidation of γ -amino alcohols **4a–d** under standard Swern-type conditions, isolating the corresponding β -amino aldehydes **5a–d** in good yields (Scheme 4, Table 2). This oxidation step proceeded in an extremely clean and smooth way, rendering directly the target compounds almost pure after work-up, which allowed us to use these β -amino aldehydes in the following transformation with no need of further purification. Nevertheless, as we also found that aldehydes **5a–d** showed an unexpected stability we proceeded to purify them by flash chromatography for better characterization process. The subsequent chain-elongation strategy was performed by a Wittig reaction with a suitable and commercially available phosphorous ylide reagent such as **6**, which allowed us to obtain the corresponding conjugated δ -amino aldehydes **7a–d** in moderate to good yields after flash column chromatography purification (Scheme 4, Table 2). The Wittig olefination proceeded with very high diastereoselectivity providing the expected *E* isomers in very high purity (¹H-NMR analysis).

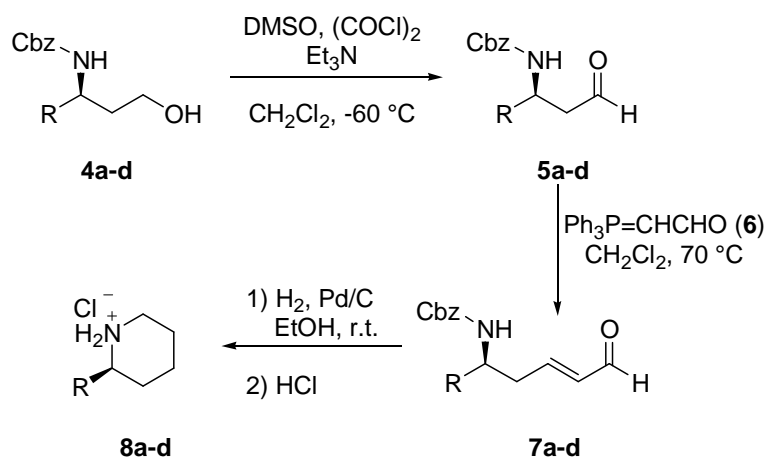
**Scheme 4****Table 2.** Asymmetric synthesis of (*R*)-2-alkylpiperidine hydrochlorides **8a–d**.

Entry	R	Prod.	Yield ^a (%)	Prod.	Yield ^a (%)	Prod.	Yield (%)
1	Me	5a	79	7a	71	8a	84
2	Et	5b	62	7b	56	8b	78
3	<i>t</i> -Bu	5c	66	7c	37	8c	99
4	Ph	5d	77	7d	84	8d	91

^aYield of pure product after flash column chromatography purification.

Indeed, these δ -amino aldehydes **7a-d** represent very suitable precursors of the desired piperidine structures *via* a cascade process involving hydrogenation of the C=C double bond, followed by removal of the *N*-Cbz protecting group and a final intramolecular reductive amination step.⁸ Therefore, derivatives **7a-d** were treated with H₂ in the presence of 10% Pd/C, yielding cleanly the final heterocycles in excellent yield. In order to easily handle these compounds, in particular those of high volatility, the crude reaction mixture was treated with concentrated HCl and hence, the corresponding piperidine hydrochlorides **8a-d** were isolated after crystallization (Scheme 4). It has to be mentioned that hydrochloride **8a**, a derivative of the naturally occurring alkaloid (*R*)-*pipecoline*, was obtained in a 47% overall yield from the corresponding alcohol **4a** and in 29% yield from the corresponding aza-Michael adduct **2a**. The recorded data for the specific rotation value of compound **8a** matched with the reported data for natural (*R*)-*pipecoline* hydrochloride⁹ and the same applies to the other non-natural piperidines prepared by this synthetic pathway.¹⁰

On the other hand, and as it was previously mentioned, the aza-Michael reaction of lithium dibenzylamide with *O*-TBS-protected enamides derived from (*S,S*)-(+)-pseudoephedrine has been exploited in our group for the preparation of β -amino amide adducts presenting the opposite configuration at the newly created stereogenic centre (Scheme 1). With this precedent in mind enamide **1e**, in which an *n*-Pr substituent was conveniently placed at the β -carbon of the conjugate acceptor was chosen as an appropriate precursor to the target alkaloid (*S*)-*coniine*. The preparation of substrate **9** was carried out by standard *O*-silylation of the corresponding (*S,S*)-pseudoephedrine enamide **1e** with TBSOTf (Scheme 5). The aza-Michael reaction of lithium dibenzylamide with enamide **9** yielded the corresponding β -amino amide **2'e** after removal of the TBS group by treatment of the crude reaction mixture with TBAF. HPLC analysis showed that the obtained major diastereomer corresponded to **2'e** with the opposite configuration at C3 with respect to that found in adducts **2a-d**, which was in good agreement with our previously reported diastereodivergent approach. Fortunately, and despite the moderate diastereoselectivity obtained in this aza-Michael reaction, compound **2'e** could be isolated in 98% d.e. after flash column chromatography, affording the necessary diastereomerically enriched material required in order to synthesize the desired piperidine alkaloid.

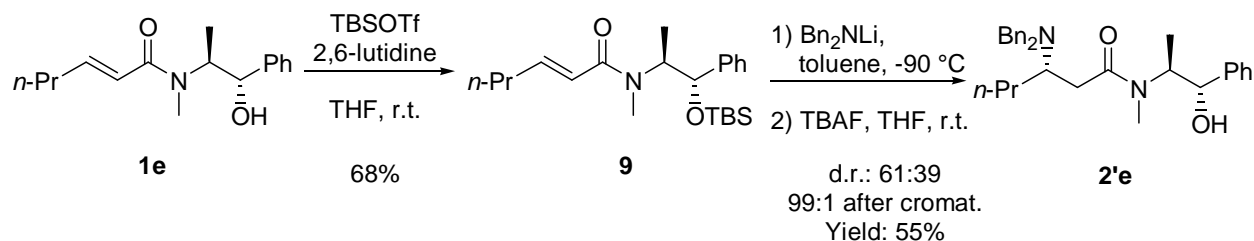

Scheme 5

Next, debenylation followed by treatment with dibenzyl dicarbonate afforded the *N*-protected β -amino amide **3'e** in good yield and with no isomerization at C3 (Scheme 6). The LAB-mediated reduction of **3'e** led to the corresponding γ -amino alcohol *ent*-**4e** in good yield and with no loss of optical purity as confirmed by chiral HPLC. Subsequently, and following the strategy described before, alcohol *ent*-**4e** was oxidized to the corresponding β -amino aldehyde *ent*-**5e**, which was transformed into the corresponding α,β -unsaturated δ -amino aldehyde *ent*-**7e** after Wittig reaction with commercially available stabilized ylide **6**. The hydrogenation/deprotection/reductive amination sequence took place smoothly furnishing (*S*)-*coniine*

hydrochloride *ent-8e* after acidic treatment. The obtained specific rotation value for a sample of *ent-8e* matched with that reported in literature.¹¹

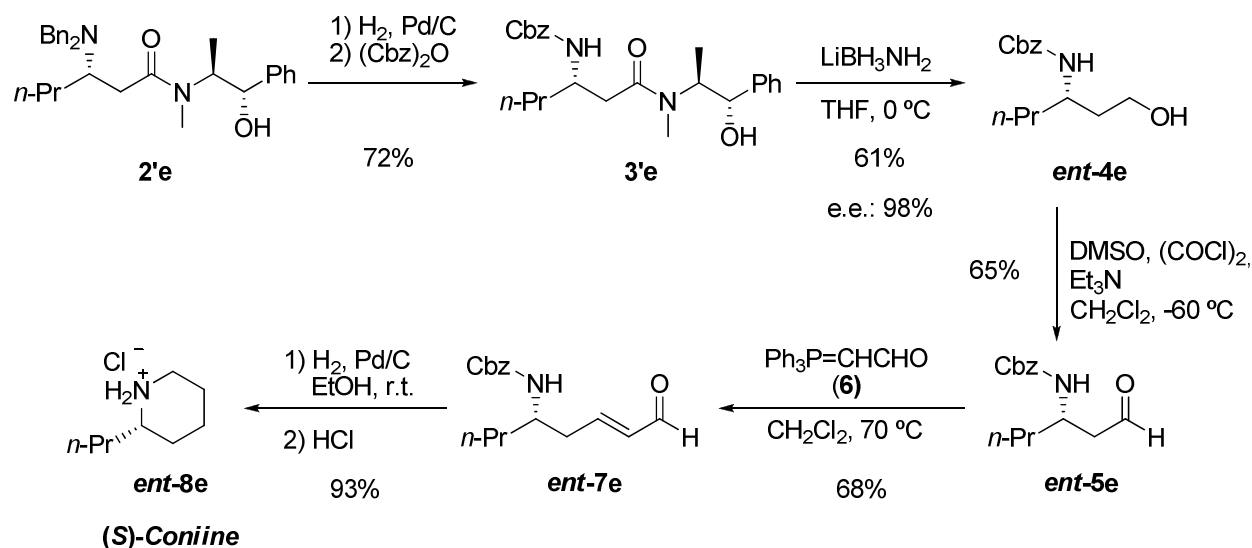

To sum up, we have shown that our previously reported protocol for carrying out stereodivergent aza-Michael reactions using (*S,S*)-(+)-pseudoephedrine as chiral auxiliary can be a very reliable tool for the asymmetric synthesis of valuable chiral compounds such as 2-alkylpiperidines, including naturally occurring (*R*)-*pipecoline* and (*S*)-*coniine*. The synthetic route presented herein is very straightforward, employs simple transformations and furnishes the final heterocycles in very high optical purity. The most remarkable feature of this methodology is that the final compounds can be obtained with any desired configuration at their stereogenic centre using in all cases the same chirality source for exerting the desired high degree of stereocontrol, with no need for the availability of both enantiomeric forms of the chiral auxiliary employed.

2.2. Asymmetric synthesis of (-)- β -conhydrine

Conhydrine belongs to the family of 2-(1-hydroxyalkyl)piperidines, which have attracted considerable attention from the synthetic organic chemists due to the potent antiviral and antitumour activity displayed.¹² In the particular case of *conhydrine*, two different diastereoisomers, namely α -*conhydrine* and β -*conhydrine* (Figure 2), have been isolated from the seeds and leaves of the poisonous plant *Conium Maculatum L.*

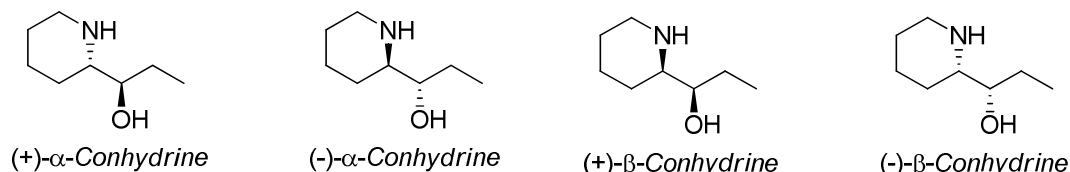

Since its first isolation in 1856,¹³ several non-stereocontrolled¹⁴ and stereocontrolled¹⁵ syntheses have been reported. However, in contrast to the wide number of reports describing the asymmetric synthesis of the α -isomer of *conhydrine*, the examples related to the asymmetric synthesis of β -*conhydrine* are much

scarce. In fact, to the best of our knowledge, there are only three literature precedents related to the synthesis of the natural enantiomer (+)- β -conhydrine^{15a,j,n} and other two papers have shown the preparation of the non natural enantiomer, (-)- β -conhydrine.^{15f,i}

With these precedents in mind, we became interested in carrying out the synthesis of (-)- β -conhydrine as a test molecule for us to check the applicability of our recently developed methodology for the stereoselective modular synthesis of α -amino ketones (Scheme 7). In this transformation, we have set up an efficient protocol for carrying out the addition of Grignard reagents to the azomethine moiety of an α -imino glyoxylamide derived from (+)-(*S,S*)-pseudoephedrine affording the expected α -amino adducts in good yields and diastereoselectivities.¹⁶ The access to enantioenriched α -amino ketones was subsequently achieved by selective and almost epimerization-free 1,2-addition of organolithium reagents across the amide C=O bond.

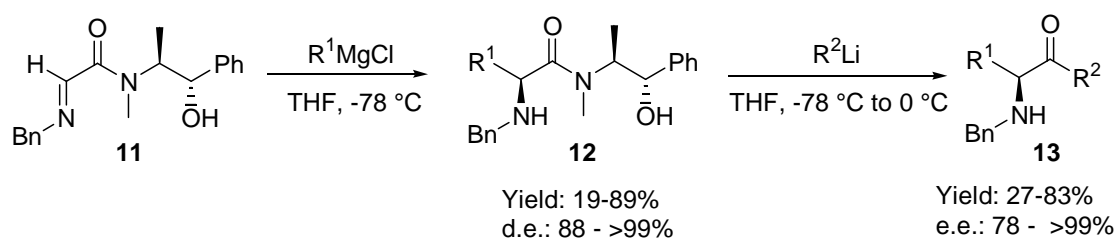

Scheme 7

Therefore, the synthesis of the target alkaloid was planned according to the retrosynthetic approach shown in Scheme 8, in which the piperidine alkaloid could be obtained from a 6-acylpiperidin-2-one precursor through several consecutive reductions, being the diastereoselective reduction of the ketone moiety a critical step of the synthesis. The building up of the piperidinone skeleton is proposed to be carried out by ring closing metathesis (RCM) from a conveniently functionalized α -amino ketone, which in turn should be accessible in an enantioenriched form by applying the already mentioned protocol set up by our research group.

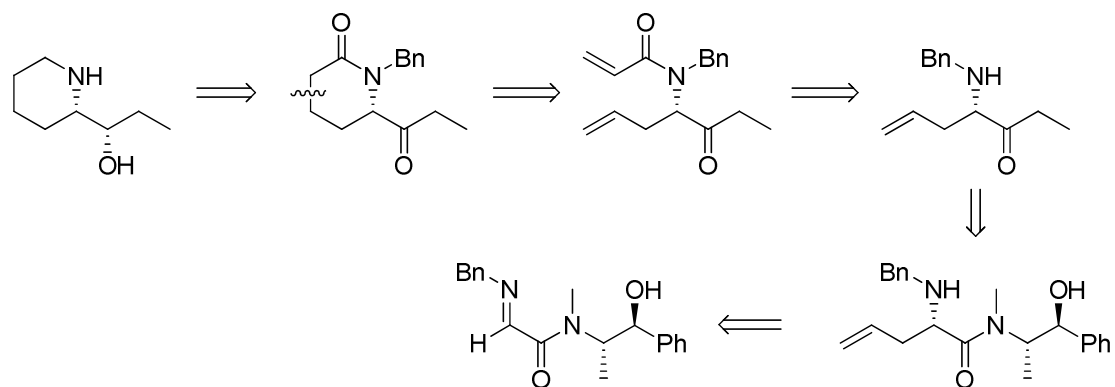

Scheme 8

We started the synthesis with the preparation of the enantioenriched chiral α -amino ketone **13**, starting from (*S,S*)-(+)-pseudoephedrine α -imino glyoxylamide **11**, according to our described procedure (Scheme

9).¹⁶ Therefore, α -iminoamide **11** was prepared by condensation between morpholinone **10** and benzylamine and next, we proceeded to carry out the diastereoselective addition of allylmagnesium chloride to this substrate **11**, which is found to be present in the reaction medium as a mixture of tautomeric cyclic and acyclic forms and in which the open-chain tautomer readily undergoes the diastereoselective 1,2-addition reaction to the azomethine moiety. Next, the enantioenriched α -amino ketone **13** was obtained by carrying out the selective monoaddition of ethyllithium across the C=O bond of the amide moiety, leading to the target compound in moderate yield and remarkably, with no epimerization of its stereocentre. In this case, the pseudoephedrine amino alcohol moiety showed to play a crucial role in the reaction by stabilizing the tetrahedral intermediate formed during this step and avoiding the competitive overaddition reaction, with similar efficiency as morpholine or Weinreb amides do.¹⁷

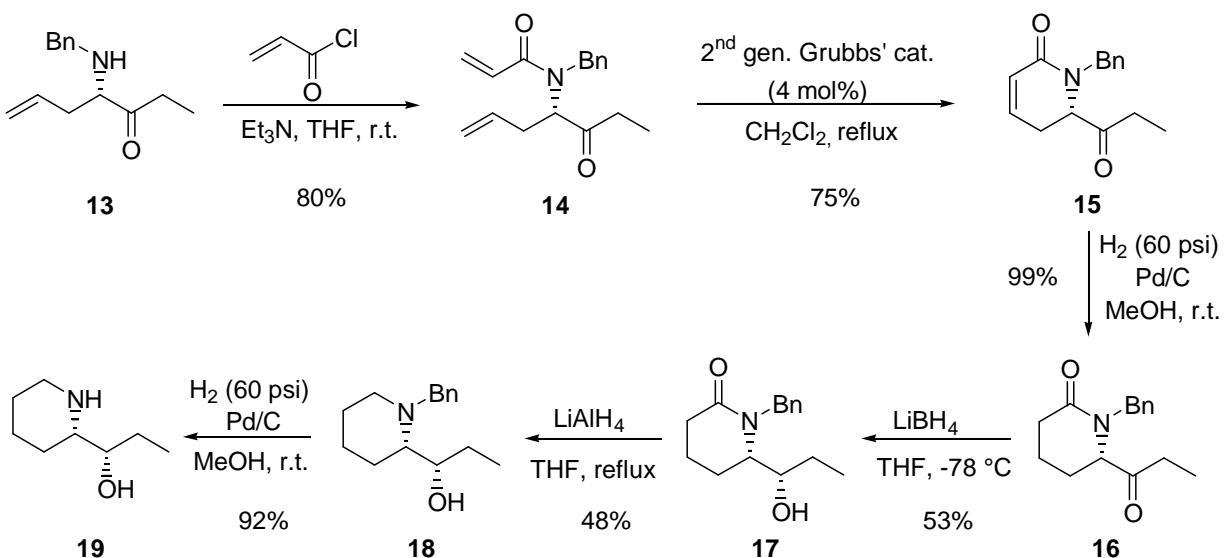
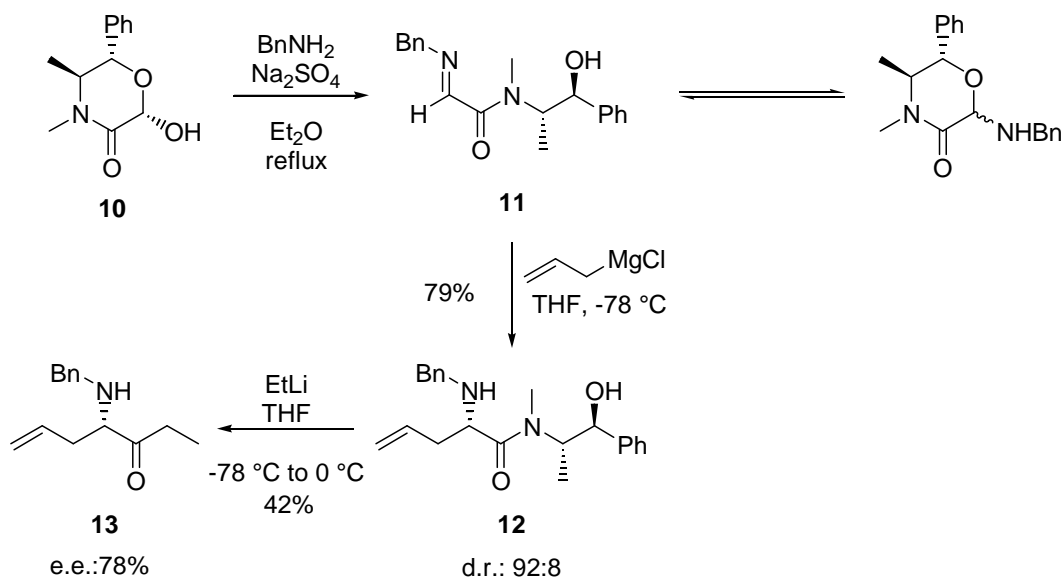

We next proceeded with the *N*-acylation of α -amino ketone **13** under standard conditions, isolating the corresponding ketoamide **14** in good yield (Scheme 10) and then, after refluxing a solution of **14** in dry

dichloromethane for 48 hours in the presence of second generation Grubbs catalyst, we were able to isolate the expected dihydropyridinone **15** in 75% yield. Catalytic hydrogenation with Pd/C furnished derivative **16** with no presence of any by-product arising from a debenzoylation process which could eventually occur under the reaction conditions employed. The diastereoselective reduction of the ketone moiety was achieved using lithium borohydride as the reducing agent and working at low temperatures, which allowed us to isolate piperidinone **17** in a moderate yield as a single diastereomer, as indicated by ^1H - and ^{13}C -NMR analysis. The synthesis was completed by LAH-promoted reduction of the lactam moiety followed by debenzoylation under hydrogenolytic conditions, which led us to the target compound **19**. Disappointingly, when we compared the $[\alpha]_{\text{D}}^{20}$ value obtained for our synthesized sample of (-)- β -conhydrine **19** with the one reported in the literature for the same isomer,¹⁸ we found a significant difference between both values, which seemed to indicate that the stereoisomeric purity of the obtained compound was not as high as it was expected. As the NMR spectrum of **19** indicated the presence of a single diastereoisomer, this should indicate that a certain degree of racemization should have occurred during the synthetic route. After analysing the performed steps and all the compounds obtained, we hypothesized that the racemization side reaction should most probably occur on the metathesis step, due to the high temperatures and rather long reaction times needed for the conversion of α -amino ketone **14** into piperidinone **15** and given the known ability of these kind of compounds to racemize because of the rather high acidity of the α -hydrogen present at the stereogenic centre.

We therefore modified the synthetic route according to the retrosynthetic approach shown in Scheme 11. In this second approach, we still maintained the metathesis reaction as the key step regarding the formation of the piperidine ring but we decided to carry out the reduction of the ketone moiety before the metathesis step, therefore avoiding the possibility of racemisation at this stage. We also modified the approach by introducing an allyl group as the *N*-substituent of the starting (*S,S*)-(+)-pseudoephedrine glyoxylimine, which would reduce the synthetic steps by avoiding the reduction of the lactam moiety and also would help in the metathesis reaction due to the higher reactivity of the allyl group *vs* the acyloyl towards the metathesis reaction.¹⁹

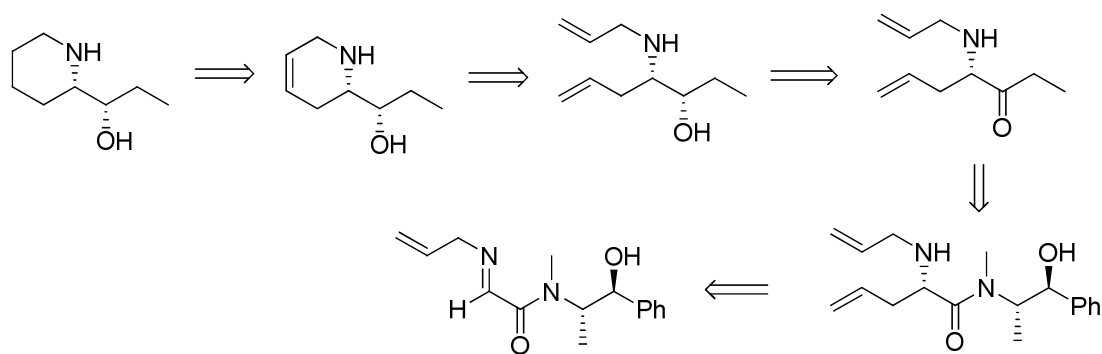

Scheme 11

We prepared the starting chiral *N*-allyl- α -imino amide **20** derived from pseudoephedrine (Scheme 12), starting from morpholinone **10** and allylamine, following the same procedure as the one employed for the preparation of imino amide **11**, also observing that, as it happened with **11**, α -imino amide **20** was obtained mainly as its cyclic morpholinone tautomer as its NMR spectra indicated. Next, we proceeded to carry out

the addition of allylmagnesium chloride to α -imino amide **20** under our optimized conditions, which furnished the expected α -amino amide, adduct was then obtained in moderate yield but with a comparable diastereoselectivity as the one obtained in the addition of allylmagnesium bromide to **11** (see Scheme 9). After that, we continued with the formation of the enantioenriched α -amino ketone **22** carrying out the addition of ethyllithium to the pseudoephedrine amide moiety, obtaining *N*-allyl- α -amino ketone **22** in moderate yield. We were not able to determine the optical purity of **22** at this stage because it was not possible for us to find the appropriate conditions to separate the corresponding racemic mixture either by chiral HPLC or GC.

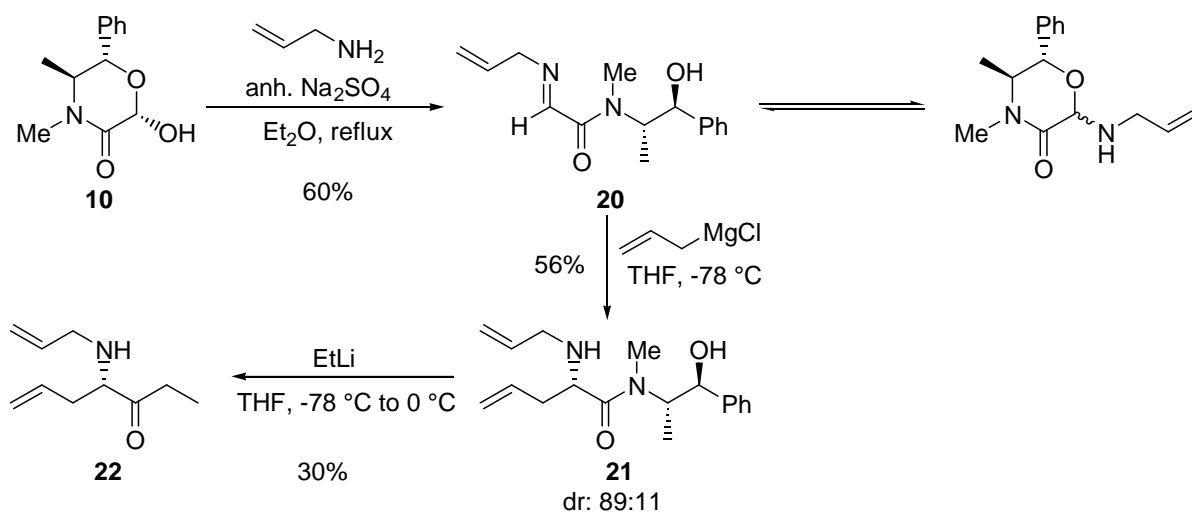

Scheme 12

Continuing with the synthesis, we proceeded to create the second stereogenic centre of the final product through diastereoselective reduction of the ketone moiety, also employing lithium borohydride as the reducing agent and working at low temperatures (Scheme 13).

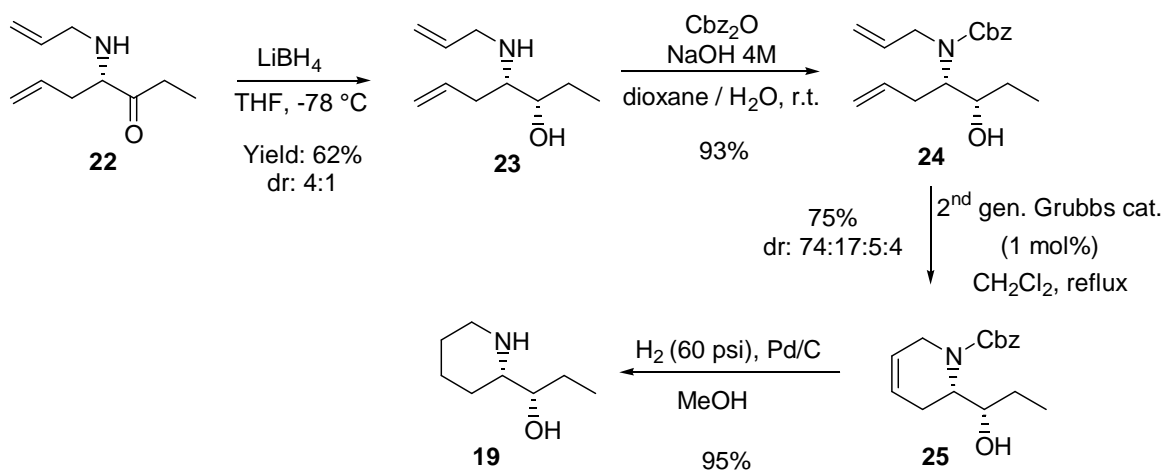

Scheme 13

The resulting amino alcohol **23** was obtained in a moderate yield and as a 4:1 mixture of diastereoisomers, judging by its ^{13}C -NMR spectra. We tried directly the metathesis reaction on substrate **23** but with no success in many reaction conditions tested and therefore we decided to carry out the protection

of the amine moiety prior to the metathesis step. With protected derivative **24** in hands, the metathesis reaction took place smoothly providing piperidinone **25** in good yield and requiring a much shorter reaction time than the metathesis reaction employed in our first approach to (–)- β -conhydrine. We also carried out a chiral HPLC analysis on piperidinone **25** obtaining a 74:17:5:4 ratio of isomers, which is consistent with the diastereomeric purity observed for the formation of precursor **21**, in which the first stereocentre was generated, and with the 4:1 *syn/anti* diastereomer ratio observed in the diastereoselective reduction of **22**. Finally, completion of the synthesis was achieved by catalytic hydrogenation, which also led to removal of the *Cbz* protecting group and therefore delivering (–)- β -conhydrine. The obtained specific rotation value for the sample of (–)- β -conhydrine **19** obtained by this new approach, was this time much more similar to that reported in the literature.²⁰

To sum up, we have shown that our recently reported protocol for carrying out the stereoselective synthesis of α -amino ketones can be a reliable tool for the asymmetric synthesis of key chiral building blocks applicable to the synthesis of valuable natural products such as the piperidine alkaloid (–)- β -conhydrine. This strategy relies on a sequence of reactions consisting on the diastereoselective 1,2-addition of Grignard reagents to α -imino amides derived from (*S,S*)-(+)-pseudoephedrine followed by selective 1,2-addition of organolithium reagents across the amide moiety and delivers α -amino ketones in high optical purities. Simple subsequent transformations, in which another key step consists on the formation of the piperidine heterocycle by ring closing metathesis reaction promoted by Grubbs catalyst, has allowed us to prepare the target compound in a simple and reliable way.

3. Organocatalytic asymmetric synthesis of pyrrolidines

Although it was already known many decades ago that small organic molecules were able to catalyze reactions in a stereoselective way, it was not until the last few years that asymmetric organocatalysis has become one of the most active fields of research in organic chemistry.²¹ The high efficiencies and selectivities attained by many organocatalytic transformations have been the “driving force” for many research groups to engage in the development of novel organocatalytic procedures for performing transformations which were typically run using transition-metal catalysis. Further advantages of this methodology are connected to the operational simplicity and to the fact that organic catalysts are very often more robust, economic and easier to handle when compared to the corresponding transition-metal species typically employed to promote the same reactions. Moreover, the fact that the presence of hazardous metals is precluded, makes this methodology even more interesting from the environmental point of view. However, despite the impressive advance gained in this field in the last years, many transformations still remain elusive and it is also very often found that the substrate scope is rather narrow compared with the corresponding transition-metal catalyzed transformation (*e.g.* the amine-catalyzed reactions are restricted to the use of aldehydes or ketones able to form azomethine compounds). For this reason, it is very often found at present that asymmetric organocatalysis more conveniently complements rather than competes with transition-metal catalysis or biocatalysis.

Proline and other chiral secondary amines have proven to be extremely useful catalysts for many C-C and C-X bond-forming reactions and, in this context, our research group has also made some important contributions in the field. In particular, we have faced the asymmetric synthesis of pyrrolidines by two different approaches. On the one hand, we have optimized an extremely efficient and versatile protocol for

carrying out the enantioselective [3+2] cycloaddition of azomethine ylides and α,β -unsaturated aldehydes, which delivers directly the target pyrrolidines in excellent yields, diastereo- and enantioselectivities. Alternatively, we have also set up the enantioselective Michael reaction of aldehydes to a particular functionalized nitroalkene such as β -nitroacrolein dimethylacetal and afterwards we have applied the obtained Michael adducts to the asymmetric synthesis of pyrrolidines containing two or three contiguous stereocentres by simple procedures mainly based on cascade processes.

3.1. Organocatalytic enantioselective [3+2] cycloaddition of azomethine ylides and α,β -unsaturated aldehydes

The catalytic asymmetric [3+2] cycloaddition reaction can be considered as one of the most powerful and reliable tools for the enantioselective synthesis of five-membered heterocyclic systems.²² The asymmetric [3+2] cycloaddition of azomethine ylides and alkenes is of particular interest because it allows the preparation of enantiomerically enriched pyrrolidine structures,²³ which are constituents of many natural products and pharmaceuticals. However, despite the intensive efforts made in the last years by several research groups, which have developed several very efficient protocols for performing this reaction using chiral metal complexes as catalysts,²⁴ the organocatalytic asymmetric version of this important transformation still remains elusive.

In this context, McMillan and co-workers have recently shown that Diels-Alder cycloaddition reactions can take place in a very efficient manner under organocatalytic conditions owing to the formation of an iminium ion intermediate and a consequent decrease in the energy of the lowest unoccupied molecular orbital (LUMO) of the dienophile.^{25,26} The group of MacMillan have also applied this concept to the [3+2] cycloaddition using nitrones as 1,3-dipoles.²⁷ With these precedents in mind, we have recently developed the first example of an organocatalytic enantioselective [3+2] cycloaddition reaction using azomethine ylides as 1,3-dipoles (Scheme 14).²⁸ Our reaction design is based on the known ability showed by α -amino acid imines to undergo thermal 1,2-prototropy to produce azomethine ylides in a kinetically controlled process,²⁹ being the acidity of the α hydrogen atom a key parameter in terms of whether or not this process might occur.³⁰ We envisaged that imines of type **26** would undergo this 1,2-prototropy process very readily to afford a stabilized azomethine ylide, which would react with an α,β -unsaturated aldehyde under organocatalytic conditions upon the activation of the aldehyde as an iminium ion. Differentiation of the enantiotopic faces of the dienophile as a result of the chirality of the secondary amine catalyst would lead to the formation of an enantiomerically enriched pyrrolidine **27**.

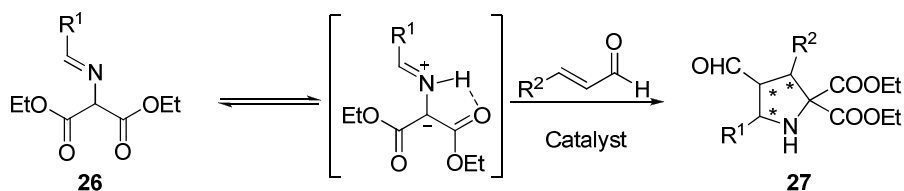

Scheme 14

After a number of experiments directed to the identification of the most efficient chiral secondary amine catalyst, employing the cycloaddition of imine **26a** ($R^1=Ph$) and crotonaldehyde ($R^2=Me$) as a model reaction, we came to the conclusion that α,α -diphenylprolinol (**28**) provided the best results, obtaining the

cycloaddition product as a single *endo* isomer and with excellent enantioselectivity (Scheme 15). We also found that the reaction proceeded more efficiently in polar solvents such as THF or DMF, most probably as a result of their ability to stabilize the 1,3-dipole formed upon 1,2-protropy, and very interestingly, we also found that the inclusion of water as an additive in the transformation resulted in a significant acceleration of the reaction. Having established an optimal protocol for the reaction, we examined the scope and limitations of the method with regard to the α,β -unsaturated aldehyde and imine substrates (Table 3).

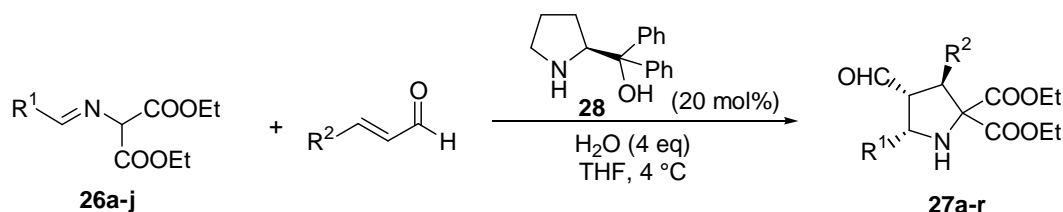

Scheme 15

Table 3. Scope of the organocatalytic enantioselective [3+2] cycloaddition reaction between α,β -unsaturated aldehydes and azomethine ylides developed in our group.

Entry	Prod.	R ¹	R ²	Yield ^a (%)	<i>endo/exo</i> ^b	e.e. ^c (%)
1	27a	Ph	Me	89	>95:5	98
2	27b	Ph	Et	91	>95:5	97
3	27c	Ph	<i>n</i> -Pr	87	>95:5	97
4	27d	Ph	<i>i</i> -Pr	85	>95:5	95
5	27e	Ph	<i>n</i> -Bu	88	>95:5	99
6	27f	Ph	Ph	82	>95:5	>99
7	27g	Ph	<i>p</i> -NO ₂ C ₆ H ₄	80	>95:5	94
8	27h	Ph	<i>p</i> -MeOC ₆ H ₄	91	92:8	>99
9	27i	Ph	2-furyl	90	>95:5	99
10	27j	<i>p</i> -MeOC ₆ H ₆	Me	88	93:7	85
11	27k	(3,4-OCH ₂ O)C ₆ H ₃	Me	93	>95:5	>99
12	27l	3,5-(MeO) ₂ C ₆ H ₃	Me	91	>95:5	94
13	27m	<i>o</i> -MeOC ₆ H ₄	Me	86	99:1	93
14	27n	<i>p</i> -FC ₆ H ₄	Me	74	>95:5	98
15	27o	<i>o</i> -FC ₆ H ₄	Me	72	>95:5	93
16	27p	<i>o</i> -tolyl	Me	91	>95:5	99
17	27q	2-furyl	Me	84	>95:5	98
18	27r	(<i>E</i>)-CH ₃ CH=CH	Me	57	91:9	97

^aYield of isolated product. ^bDetermined by ¹H NMR spectroscopic analysis of the crude reaction mixture. ^cDetermined by chiral HPLC analysis of the corresponding alcohol obtained by reduction.

In all cases, the reaction proceeded smoothly to furnish the desired pyrrolidines **27** in excellent yields and with excellent diastereo- and enantioselectivities. Both linear and branched aliphatic α,β -unsaturated aldehydes, as well as enals with an aryl or heteroaryl substituents at the β position, were found to be suitable dipolarophiles in the [3+2] cycloaddition reaction with the azomethine ylide derived from **26a** (Table 3,

entries 1–9). Good results were also obtained for a variety of imine substrates **26** (Table 3, entries 10–18). It has to be pointed out that pyrrolidines **27a–r** were found to be somewhat unstable compounds and therefore, after isolation, we proceeded to carry out the reduction of the formyl group to form stable amino alcohols **29a–r** that could be characterized and stored for several weeks without decomposition (Scheme 16).

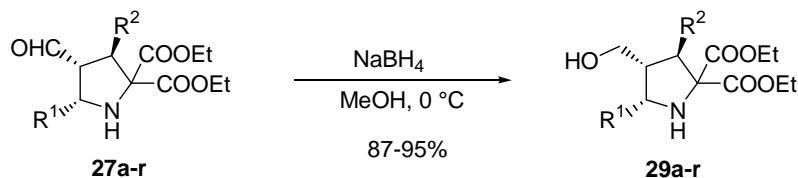

Scheme 16

The relative configuration between the three newly generated stereogenic centres on the cycloadducts **27** was determined by the usual n.O.e. experiments and the absolute configuration was determined by chemical correlation (Scheme 17). The [3+2] cycloaddition of imine **30** and crotonaldehyde under the optimized conditions, followed by reduction, furnished pyrrolidine **31** as a single *endo* isomer with 98% *ee*. Next, diastereoselective monohydrolysis followed by decarboxylation gave the proline derivative **32** as a single 2,5-*cis* diastereomer. Finally, **32** was converted into the known compound **33**³¹ by standard procedures. A new stereocentre was generated with complete selectivity in this sequence, which should facilitate the future preparation of a wide range of proline derivatives. The absolute configuration assigned to adducts **27a–r** is in agreement with the stereochemical outcome reported for other reactions in which catalyst **28** has been involved through iminium activation.³²

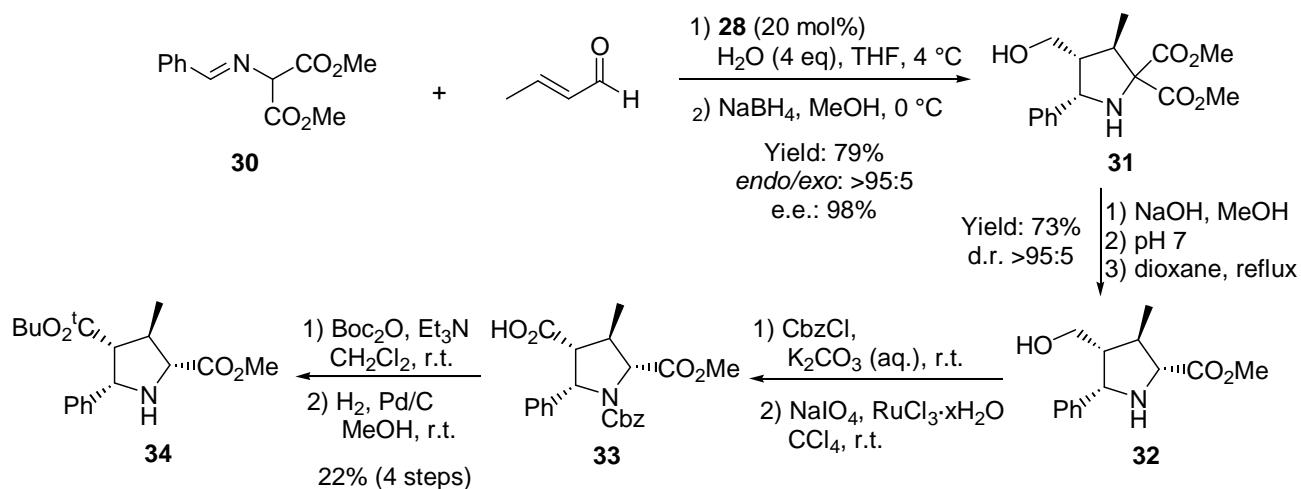

Scheme 17

In this context, we propose that the reaction should proceed *via* a mechanism as depicted in Scheme 18. Condensation of the α,β -unsaturated aldehyde with the catalyst would deliver the corresponding iminium ion intermediate in which the energy of the LUMO of the dipolarophile should be decreased, therefore becoming activated for the cycloaddition process. This should occur by interaction with the azomethine ylide, generated *in situ* from the starting imine after the 1,2-prototropy process, *via* a transition state involving an *endo*-type approach of these two reagents. The formed cycloadduct should finally undergo hydrolysis, delivering the final compound and releasing the catalyst ready to participate in a subsequent

catalytic cycle. Regarding the stereochemical outcome of the reaction, we propose that efficient facial discrimination of the chiral iminium intermediate by the bulky aryl groups of **28** leads to stereoselective *endo*-type approach of the (*E*)-1,3-dipole to the intermediate (*E*)-iminium ion across its less sterically hindered *Re* face. With regard to the role played by the water additive incorporated to the reaction in the optimal conditions, we interpret this positive influence in terms of avoiding the formation of oxazolidine by-products both in the intermediate iminium ion or in the adduct still containing the catalyst incorporated. The formation of these stable oxazolidine by-products would reduce the amount of active catalyst present in the reaction medium, consequently avoiding the progress of the reaction.

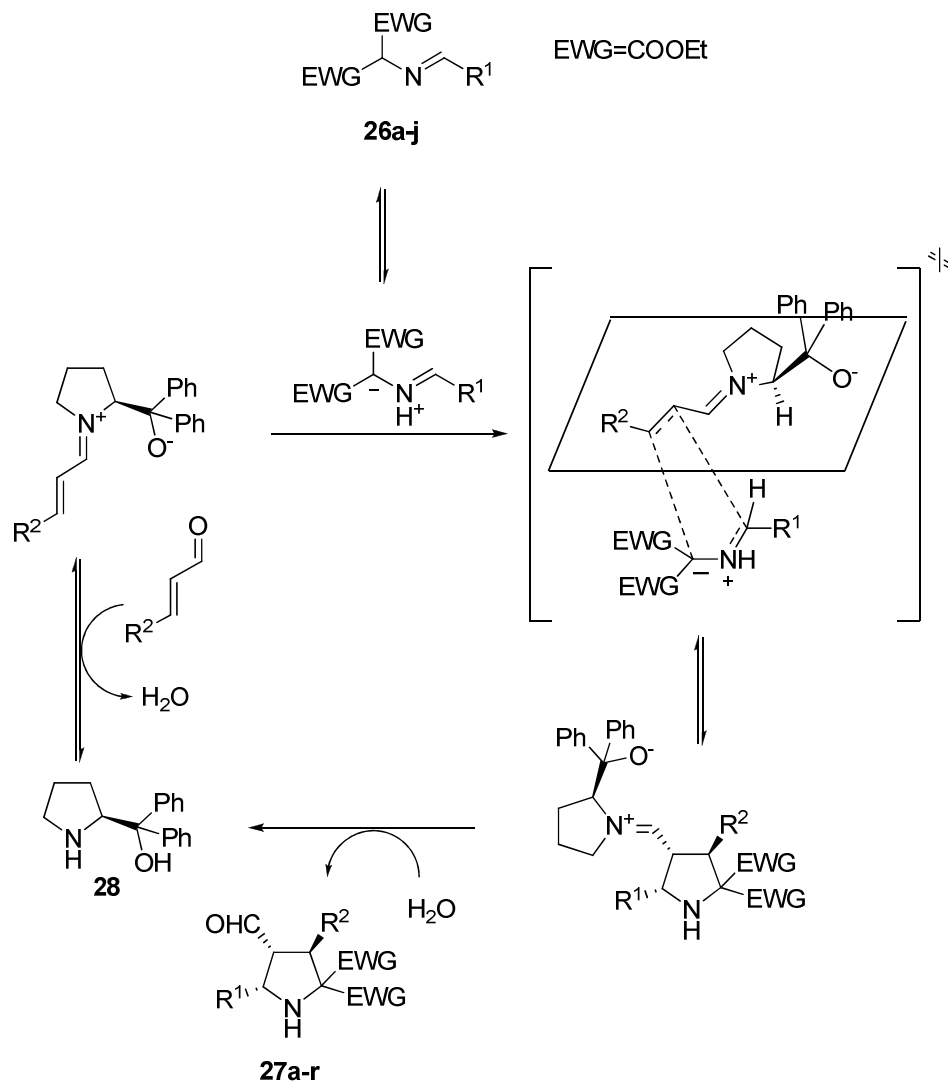

Scheme 18

In summary, we have presented the first organocatalytic enantioselective [3+2] cycloaddition reaction between α,β -unsaturated aldehydes and azomethine ylides. The reaction proceeds with complete regioselectivity and with very high diastereo- and enantioselectivity to furnish almost stereoisomerically pure highly functionalized polysubstituted pyrrolidines in excellent yields. The utility of this reaction was exemplified in the synthesis of a proline derivative in which an additional stereogenic centre was created with complete stereoselectivity.

3.2. Organocatalytic Michael reaction of aldehydes and nitroacrolein dimethylacetal. Synthesis of 3,4-disubstituted and 2,3,4-trisubstituted pyrrolidines

The organocatalytic Michael reaction has also become a powerful tool for the stereocontrolled synthesis of chiral compounds containing two or more stereogenic centres.³³ A particularly interesting variant of this transformation is the chiral amine-catalyzed conjugate addition of aldehydes to nitroalkenes,^{34,35} in which the obtained adducts constitute versatile molecules which can be transformed into many useful chiral compounds by exploiting the intrinsic reactivity of the formyl moiety and, specially, the nitro group.³⁶ However, although this transformation has been extensively studied by different research groups, the use of functionalized starting materials directed to the preparation of polyfunctionalized compounds as intermediates for the synthesis of biologically relevant molecules still remains rather unexplored.³⁷



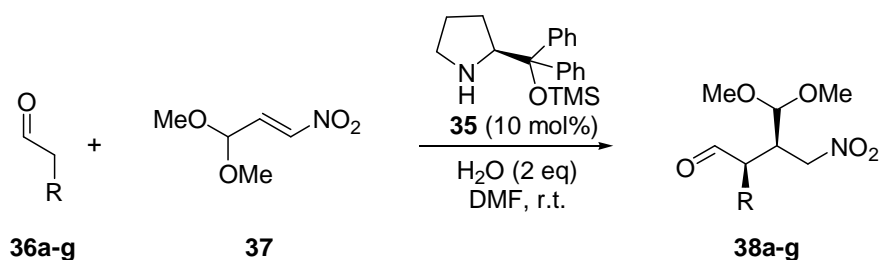

Related to this topic, previous results in our research group (Scheme 19) have demonstrated that α,α -diphenylprolinol silyl ether **35**, easily prepared from commercially available α,α -diphenylprolinol **28**, can be used as an excellent organocatalyst in the conjugate addition of structurally different aldehydes to β -nitroacrolein dimethyl acetal **37** (a functionalized nitroalkene).³⁸ The reaction proceeded with good yields and diastereoselectivities, and with excellent enantioselectivities, on a wide range of different aldehyde donors (Table 4) and, remarkably, requiring the use of 1:1 molar nucleophile/electrophile ratio. In this context, the use of β -nitroacrolein dimethyl acetal as Michael acceptor represents a truly advantage in this reaction because its high electrophilicity allows the complete consumption of the starting aldehyde donor reagent in the presence of small amounts of catalyst, in deep contrast with many of the examples previously described in the literature, in which a large excess of the aldehyde donor reagent is necessary in order to obtain complete conversion during this transformation.³⁹

The observed absolute configuration on adducts **38** can be explained according to a mechanistic pathway such as that depicted in Scheme 20. In a first step, the starting aldehyde and catalyst **35** would condense to form a stereodefined nucleophilic enamine intermediate. Next, this enamine would react with the nitroalkene electrophile and a final hydrolysis step should release the Michael adduct and the catalyst, which would be ready to participate in a subsequent catalytic cycle. The key for the success of catalyst **35** relies on the effect exerted by the substituent at the pyrrolidine ring, which results in a very efficient geometry control of the enamine intermediate together with an excellent ability to discriminate between its diastereotopic faces, which is achieved by the presence of a bulky diphenyl(trimethylsilyloxy)methyl substituent in the pyrrolidine ring. The observed *syn*-diastereoselectivity is explained by means of an acyclic synclinal transition state, as proposed by Seebach and Golinski,⁴⁰ in which electrostatic interactions between the partially positive nitrogen of the enamine and the negatively charged oxygen atoms at the nitro group are invoked.

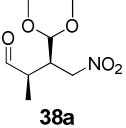
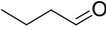
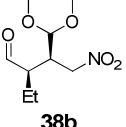
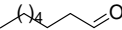
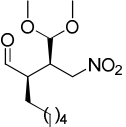
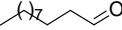
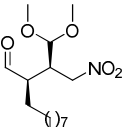

Scheme 19

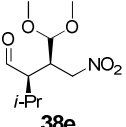
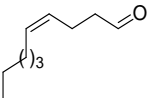
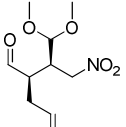
Table 4. Organocatalytic enantioselective Michael reaction of **37** and different aldehydes catalyzed by **35**.

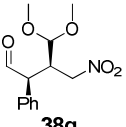
Entry	Aldehyde	Product	Time (h)	Yield ^a (%)	<i>syn/anti</i> ^b	ee (%) ^c
1		 38a	24	86	6.0:1	>99 ^d
2		 38b	48	63	11.0:1	>99
3		 38c	72	85	26:1	>99
4		 38d	72	61	>99:1	92
5		 38e	72	75	>99:1	>99
6		 38f	72	81	2.0:1	>99
7		 38g	48	85	1.5:1	>99

^aIsolated yield after flash column chromatography purification. ^bDetermined by NMR spectroscopy of the reaction mixture. ^cCalculated by chiral GC or HPLC analysis of the corresponding acetates, except nitro aldehyde **38a**.

^dCalculated by chiral GC after transformation to the corresponding acetal derived from propane-1,3-diol.

After studying the scope and limitations of our reaction, we decided to employ this new developed methodology to the synthesis of a number of different derivatives with a homoproline general structure. Thus, a short retrosynthetic analysis as shown in Scheme 21, shows that pyrrolidines can be obtained after an intramolecular aza-Michael reaction of a conveniently substituted ω -amino- α,β -unsaturated ester intermediate in which the amino group can be formed from the corresponding nitro derivative by chemoselective reduction. This ω -nitro- α,β -unsaturated ester derivative should be easily accessible from our adducts **38a–g** by a simple olefination procedure. It has to be pointed out that a key step in this synthesis relies upon the intramolecular aza-Michael step in which a third new stereogenic centre will be created. In this context, it is expected that the chiral information already present at the aminoenoate precursor would

exert the required asymmetric induction in the formation of this new stereocentre, although special attention will have to be paid to the experimental conditions required for carrying out this transformation in order to obtain the final compounds as single diastereoisomers.

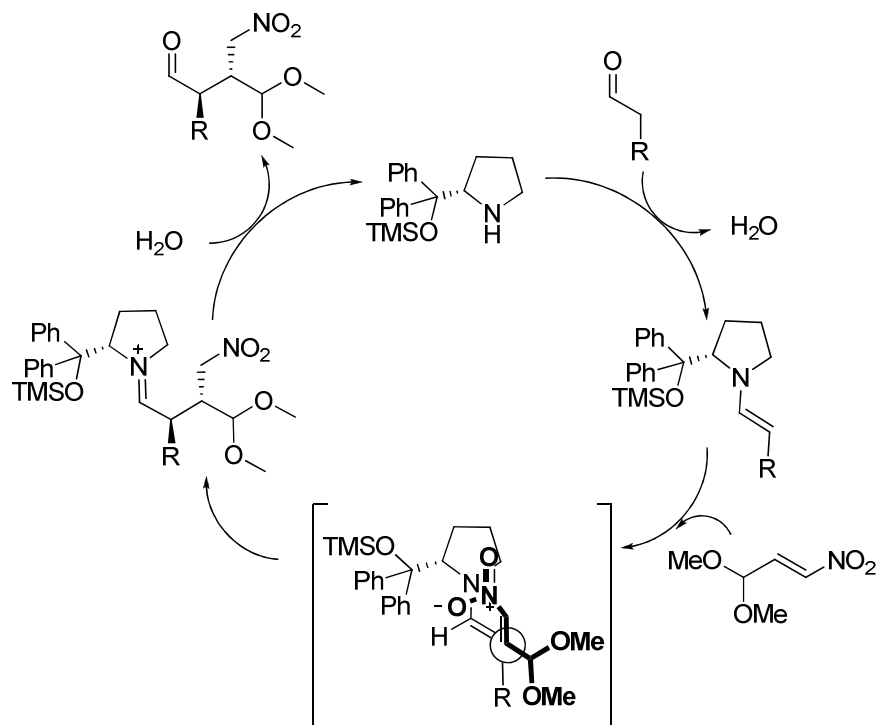

Scheme 20

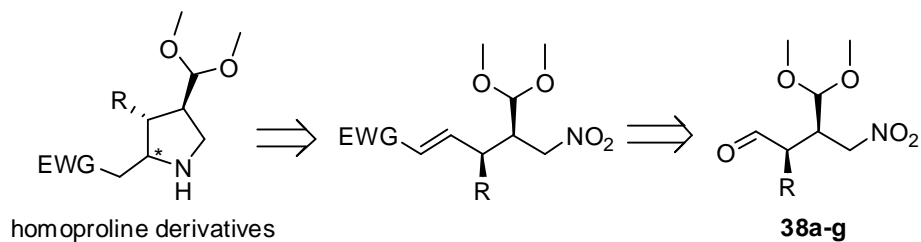

Scheme 21

We proceeded to carry out the synthesis according to the proposed synthetic plan using adduct **38a** as model substrate and therefore we started with the projected olefination reaction in order to reach to ω -nitro- α,β -unsaturated ester **39a** (Scheme 22). For this purpose, we chose a Wittig reaction, in which the Michael adduct **38a** was stirred with ethoxycarbonylmethyltriphenylphosphorane in CH_2Cl_2 at room temperature. As a result, the α,β -unsaturated ester **39a** was isolated in good yield and without epimerization at the α -stereocentre.

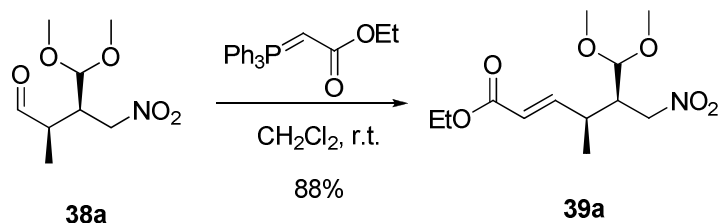

Scheme 22

We next proceeded to carry out the chemoselective reduction of the nitro group in the presence of the α,β -unsaturated ester moiety, which was carried out by treating adduct **39a** with Zn in AcOH followed by basification, standard work-up and final purification by flash chromatography (Scheme 23). To our delight, the reaction proceeded smoothly furnishing directly pyrrolidine **40a**. This is indicating that a clean and selective reduction of the nitro group happened followed by intramolecular aza-Michael reaction, which most probably occurred after basifying the reaction mixture and during work-up. In addition, we also found that the cyclization step proceeded with complete diastereoselectivity, furnishing a single diastereoisomer as NMR analysis of crude reaction mixture indicated. This is also indicating that the chirality present at the α,β -unsaturated- ω -amino ester precursor was able to exert a very effective asymmetric induction during the aza-Michael reaction step. The configuration of the newly created stereogenic centre was determined by n.O.e. experiments showing a 2,3-*trans* relationship with the methyl substituent at the adjacent stereocentre and a 2,4-*cis* relationship with the dimethoxymethyl substituent.

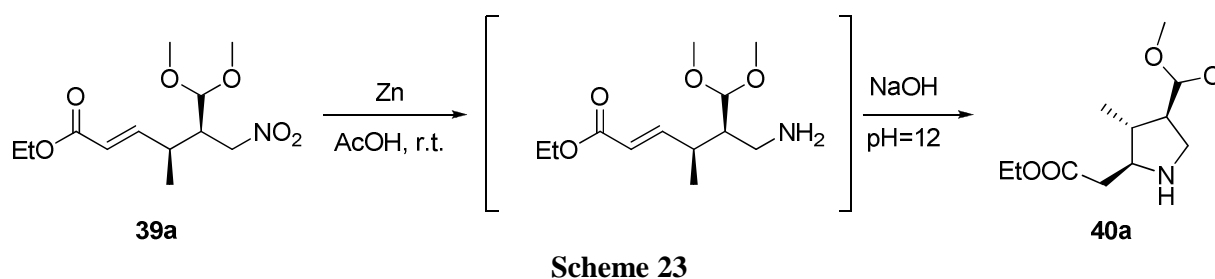

These conditions were extended to the rest of the nitroaldehydes **38b–g** showing that this reaction sequence could easily be performed in all cases furnishing the target trisubstituted homoproline products **40b–g** in only two steps (Table 5). The olefination step proceeded in all cases with good yields and without any appreciable epimerization in the stereogenic centres created during the organocatalytic enantioselective Michael reaction step. Moreover, the final reduction/cyclization step also took place with complete diastereoselectivity regarding the generation of the third stereocentre, thus furnishing cleanly the target pyrrolidines **40b–g** as single diastereoisomers of high enantiomeric purity.⁴¹

A direct access to chiral 3,4-disubstituted pyrrolidines using Michael adducts **38a–g** was also envisaged carrying out a cascade process consisting in the chemoselective reduction of the nitro group followed by intramolecular reductive amination (Table 6). To our delight, when we treated γ -nitro aldehydes **38a–g** with Zn in AcOH, a clean reaction occurred and we were able to isolate pyrrolidines **41a–g** in good yields and as a single diastereoisomers.⁴² This is also showing that the reduction/reductive amination cascade process proceeded with no epimerization in the α -esterocentre of the starting material, which was expected to be fairly racemization-prone during the reductive amination step *via* imine/enamine tautomerization.

Therefore, we have demonstrated that the adducts obtained in the fully enantio- and diastereoselective organocatalytic Michael addition of aldehydes to β -nitroacrolein dimethyl acetal could be easily transformed into highly functionalized enantioenriched pyrrolidines by two different methodologies, which constitute a very efficient, short (three steps from nitroacrolein dimethyl acetal for the synthesis of trisubstituted pyrrolidines and only two for the 3,4-disubstituted derivatives) and modular approach for the construction of differently substituted stereodefined proline derivatives. These molecules are of high interest

due to their substitution pattern containing well differentiated functionalities suitable for further modifications.

Table 5. Synthesis of the α,β -unsaturated esters **39** and pyrrolidines **40**.

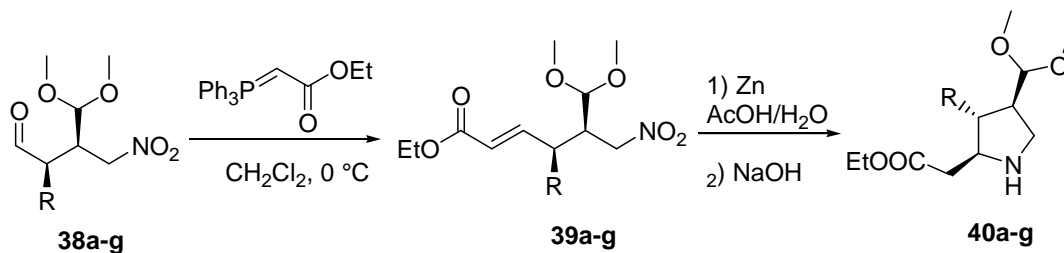

Entry	Substrate	Product	Yield ^a (%)	Product	Yield ^a (%)
1			88		68
2			85		54
3			78		66
4			74		44
5			73		71
6			45		84
7			69		51

^aIsolated yield after flash column chromatography purification.

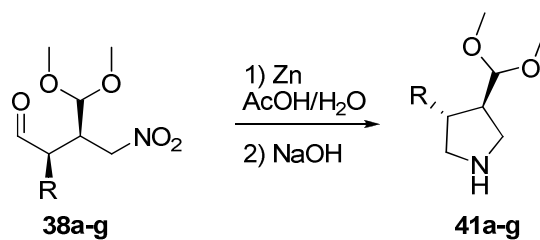
Table 6. Synthesis of 3,4-disubstituted pyrrolidines **41**.

Entry	Substrate	Product	Yield ^a (%)
1			51 ^b
2			74
3			75
4			81
5			79
6			80
7			75

^aIsolated yield after flash column chromatography purification. ^bThe reaction was carried out at -15 °C.

4. Concluding remarks

We have shown herein that two conceptually very different methodologies such as the use of chiral auxiliaries or asymmetric organocatalysis can be extremely useful tactics for the stereocontrolled synthesis of piperidine and pyrrolidine compounds. We have prepared chiral piperidines, exploiting a diastereoselective aza-Michael reaction protocol or a stereocontrolled 1,2-addition of Grignard reagents to

α -iminoglyoxylamides, in both cases using the cheap and readily available aminoalcohol (*S,S*)-(+)-pseudoephedrine as chiral auxiliary. Alternatively, we have proven that α,α -diphenylprolinol derivatives can act as excellent organocatalysts in the asymmetric synthesis of highly substituted pyrrolidines either in a single step using an enantioselective [3+2] cycloaddition with azomethine ylides as 1,3-dipoles or, alternatively, using γ -nitroaldehydes as starting materials which were in turn obtained in an enantiopure form by enantioselective Michael reaction between aldehydes and β -nitroacrolein dimethyl acetal.

Acknowledgments

This research was supported by the University of the Basque Country (Subvención General a Grupos de Investigación and UNESCO 06/06) and the Ministerio de Educación y Ciencia of Spain (CTQ 2005-02131/BQU). N. R. thanks the Spanish Ministerio de Educación y Ciencia and E. R. thanks the University of the Basque Country for their fellowships. The authors also acknowledge PETRONOR, S.A., for the generous gift of solvents.

References and notes

1. (a) Pellissier, H. *Tetrahedron* **2007**, *63*, 3235. (b) Pandey, G.; Banerjee, P.; Gadre, S. R. *Chem. Rev.* **2006**, *106*, 4484. (c) Husinec, S.; Savic, V. *Tetrahedron: Asymmetry* **2005**, *16*, 2047. (d) Najera, C.; Sansano, J. M. *Angew. Chem. Int. Ed.* **2005**, *44*, 6272. (e) Enders, D.; Thiebes, C. *Pure & Appl. Chem.* **2001**, *73*, 573.
2. For some reviews, see: (a) Pearson, M. S. M.; Mathe-Allainmat, M.; Fargeas, V.; Lebreton, J. *Eur. J. Org. Chem.* **2005**, 2159. (b) Afarinkia, K.; Bahar, A. *Tetrahedron: Asymmetry* **2005**, *16*, 1239. (c) Dhavale, D. D.; Martin, M. M. *Arkivoc* **2005**, 110. (d) Buffat, M. G. P. *Tetrahedron* **2004**, *60*, 1701. (e) Weintraub, P. M.; Sabol, J. S.; Kane, J. M.; Borcharding, D. R. *Tetrahedron* **2003**, *59*, 2953. (f) Felpin, F.-X.; Lebreton, J. *Eur. J. Org. Chem.* **2003**, 3693. (g) Bates, R. W.; Sa-Ei, K. *Tetrahedron* **2002**, *58*, 5957. (h) Enders, D.; Thiebes, T. *Pure & Appl. Chem.* **2001**, *73*, 573. (i) Laschat, S.; Dickner, T. *Synthesis* **2000**, 1781. (j) Guilloteau-Bertin, B.; Compere, D.; Gil, L.; Marazano, C.; Das, B. C. *Eur. J. Org. Chem.* **2000**, 1391. (k) Husson, H.-P.; Royer, J. *Chem. Soc. Rev.* **1999**, *28*, 383. (l) Comins, D. L. *J. Heterocycl. Chem.* **1999**, *36*, 1491.
3. For the first use of pseudoephedrine as chiral auxiliary, see: (a) Myers, A. G.; Yang, B. H.; Chen, H.; Gleason, J. L. *J. Am. Chem. Soc.* **1994**, *116*, 9361. (b) Myers, A. G.; Chen, H.; McKinstry, L.; Kopecky, D. J.; Gleason, J. L. *J. Am. Chem. Soc.* **1997**, *119*, 6496. For a review, see: (c) Myers, A. G.; Charest, M. G. *Handbook of Reagents for Organic Synthesis: Chiral Reagents for Asymmetric Synthesis*; Paquette, L. A., Ed.; Wiley Interscience: New York, 2003; p. 485.
4. For examples reported by our group in this field, see: (a) Reyes, E.; Vicario, J. L.; Carrillo, L.; Badia, D.; Uria, U.; Iza, A. *J. Org. Chem.* **2006**, *71*, 7763. (b) Reyes, E.; Vicario, J. L.; Carrillo, L.; Badia, D.; Iza, A.; Uria, U. *Org. Lett.* **2006**, *8*, 2535. (c) Iza, A.; Vicario, J. L.; Badia, D.; Carrillo, L. *Synthesis* **2006**, 4065. (d) Vicario, J. L.; Rodriguez, M.; Badia, D.; Carrillo, L.; Reyes, E. *Org. Lett.* **2004**, *6*, 3171. (e) Vicario, J. L.; Badia, D.; Carrillo, L. *J. Org. Chem.* **2001**, *66*, 5801. (f) Vicario, J. L.; Badia, D.; Carrillo, L. *J. Org. Chem.* **2001**, *66*, 9030. (g) Anakabe, E.; Vicario, J. L.; Badia, D.; Carrillo, L.; Yoldi, V. *Eur. J. Org. Chem.* **2001**, 4343. (h) Vicario, J. L.; Badia, D.; Domínguez, E.; Rodríguez, M.; Carrillo, L. *J. Org. Chem.* **2000**, *65*, 3754. See also Refs. 5 and 6. For contributions by other groups, see: (i) Kummer, D. A.; Chain, W. J.; Morales, M. R.; Quiroga, O.; Myers, A. G. *J. Am. Chem. Soc.* **2008**, *130*, 13231. (j) Smitrovich, J. H.; Boice, G. N.; Qu, C.; Dimichelle, L.; Nelson, T. D.; Huffman, M. A.; Murry, J.; McNamara, J.; Reider, P. J. *Org. Lett.* **2002**, *4*, 1963. (k) Hutchison, P. C.; Heightman, T. D.; Procter, D. J. *Org. Lett.* **2002**, *4*, 4583. (l) Myers, A. G.; Barbay, J. K.; Zhong, B. *J. Am. Chem. Soc.* **2001**, *123*, 7207. (m) Myers, A. G.; McKinstry, L. *J. Org. Chem.* **1996**, *61*, 2428.
5. Etxebarría, J.; Vicario, J. L.; Badía, D.; Carrillo, L. *J. Org. Chem.* **2004**, *69*, 2588.
6. Etxebarría, J.; Vicario, J. L.; Badía, D.; Carrillo, L.; Ruiz, N. *J. Org. Chem.* **2005**, *70*, 8790.

7. For other selected synthetic approaches to enantioenriched alkylpiperidines from β -amino carbonyl derivatives, see: (a) Robertson, J.; Stafford, P. M.; Bell, S. J. *J. Org. Chem.* **2005**, *70*, 7133. (b) Davis, F. A.; Yang, B. *J. Am. Chem. Soc.* **2005**, *127*, 8398. (c) Davis, F. A.; Zhang, J.; Li, Y.; Xu, H.; DeBrosse, C. *J. Org. Chem.* **2005**, *70*, 5413. (d) Clive, D. L. J.; Yu, M.; Li, Z. *Chem. Commun.* **2005**, 906. (e) Burke, A. J.; Davies, S. G.; Garner, A. C.; McCarthy, T. D.; Roberts, P. M.; Smith, A. D.; Rodriguez-Solla, H.; Vickers, R. *J. Org. Biomol. Chem.* **2004**, *2*, 1387. (f) Marin, J.; Didierjean, C.; Aubry, A.; Casimir, J.-R.; Briand, J.-P.; Guichard, G. *J. Org. Chem.* **2004**, *69*, 130. (g) Lee, H. K.; Chun, J. S.; Pak, C. S. *Tetrahedron* **2003**, *59*, 6445. (h) Leflemme, N.; Dallemagne, P.; Rault, S. *Tetrahedron Lett.* **2001**, *42*, 8997. (i) Grison, C.; Genève, S.; Coutrot, P. *Tetrahedron Lett.* **2001**, *42*, 3831. (j) Ma, D.; Sun, H. *J. Org. Chem.* **2000**, *65*, 6009. (k) Davies, S. B.; McKerverey, M. A. *Tetrahedron Lett.* **1999**, *40*, 1229. (l) Kawakami, T.; Ohtake, H.; Arakawa, H.; Okachi, T.; Imada, Y.; Murahashi, S.-I. *Org. Lett.* **1999**, *1*, 107. (m) Davis, F. A.; Szewczyk, J. M. *Tetrahedron Lett.* **1998**, *39*, 5951.
8. For some selected examples on the formation of piperidines *via* intramolecular reductive amination, see: (a) Masuda, Y.; Tashiro, T.; Mori, K. *Tetrahedron: Asymmetry* **2006**, *17*, 3380. (b) Adriaenssens, L. V.; Austin, C. A.; Gibson, M.; Smith, D.; Hartley, R. C. *Eur. J. Org. Chem.* **2006**, 4998. (c) Kandula, S. R. V.; Kumar, P. *Tetrahedron* **2006**, *62*, 9942. (d) Chavan, S. P.; Praveen, C. *Tetrahedron Lett.* **2004**, *45*, 421. (e) La Ferla, B.; Bugada, P.; Cipolla, L.; Peri, F.; Nicotra, F. *Eur. J. Org. Chem.* **2004**, 2451. (f) Lee, Y.-S.; Shin, Y.-H.; Kim, Y.-H.; Lee, K.-Y.; Oh, C.-Y.; Pyun, S.-J.; Park, H.-J.; Jeong, J.-H.; Ham, W.-H. *Tetrahedron: Asymmetry* **2003**, *14*, 87. (g) Randl, S.; Blechert, S. *J. Org. Chem.* **2003**, *68*, 8879. (h) Yamazaki, N.; Dokoshi, W.; Kibayashi, C. *Org. Lett.* **2001**, *3*, 193. (i) Kim, G.; Jung, S.; Kim, W. *Org. Lett.* **2001**, *3*, 2985. (j) Enders, D.; Kirchoff, J. H. *Synthesis* **2000**, 2099. See also Ref. 7c.
9. $[\alpha]_{20}^D = +3.9$ ($c=1.1$, EtOH) for a sample of (*R*)-pipercoline hydrochloride obtained by us; lit. $[\alpha]_{20}^D = +3.97$ ($c=1.0$, EtOH). Andres, J. M.; Herraiz-Sierra, I.; Pedrosa, R.; Perez-Encabo A. *Eur. J. Org. Chem.* **2000**, 1719.
10. Compound **8b**: $[\alpha]_{20}^D = -1.2$ ($c=0.2$, EtOH); lit. $[\alpha]_{20}^D = -1.42$ ($c=0.2$, EtOH). Ref. 9. Compound **8d**: $[\alpha]_{20}^D = +3.0$ ($c=0.2$, EtOH); lit. $[\alpha]_{20}^D = +3.1$ ($c=0.2$, EtOH) for the *R* isomer: Katritzky, A. R.; Qiu, G.; Yang, B.; Steel, P. J. *J. Org. Chem.* **1998**, *63*, 6699.
11. $[\alpha]_{20}^D = +9.0$ ($c=0.2$, EtOH) for a sample of (*S*)-coniine hydrochloride obtained by us; lit. $[\alpha]_{20}^D = +9.4$ ($c=0.2$, EtOH). Refs. 9 and 10.
12. (a) Michael, J. P. *Nat. Prod. Rep.* **1997**, *14*, 619. (b) Casiraghi, G.; Zanardi, F.; Rassu, G.; Spanu, P. *Chem. Rev.* **1995**, *95*, 1677.
13. Wertheim, T. *Liebigs Ann. Chem.* **1856**, *100*, 328.
14. (a) Beak, P.; Lee, W. K. *J. Org. Chem.* **1993**, *58*, 1109. (b) Pilard, S.; Vaultier, M. *Tetrahedron Lett.* **1984**, *25*, 1555. (c) Shono, T.; Matsumura, Y.; Kanazawa, T. *Tetrahedron Lett.* **1983**, *24*, 4577. (d) Stock, G.; Jacobson, R. M.; Levitz, R. *Tetrahedron Lett.* **1979**, *20*, 771. (e) Galinovsky, F.; Mulley, H. *Monatsch. Chem.* **1948**, *79*, 426.
15. (a) Lebrun, S.; Couture, A.; Deniau, E.; Grandclaude, P. *Tetrahedron: Asymmetry* **2008**, *19*, 1245. (b) Jamieson, A. G.; Sutherland, A. *Org. Lett.* **2007**, *8*, 1609. (c) Voituriez, A.; Ferreira, F.; Chemla, F. *J. Org. Chem.* **2007**, *72*, 5358. (d) Chang, M.-Y.; Kung, Y.-H.; Chen, S.-T. *Tetrahedron* **2006**, *62*, 10843. (e) Pandey, S. K.; Kumar, P. *Tetrahedron Lett.* **2005**, *46*, 4091. (f) Kandula, S. V.; Kumar, P. *Tetrahedron: Asymmetry* **2005**, *16*, 3268. (g) Kandula, S. V.; Kumar, P. *Tetrahedron Lett.* **2003**, *44*, 1957. (h) Enders, D.; Nolte, B.; Raabe, G.; Runsink, J. *Tetrahedron: Asymmetry* **2002**, *13*, 285. (i) Agami, C.; Couty, F.; Rabasso, N. *Tetrahedron* **2001**, *57*, 5393. (j) Comins, D. L.; Williams, A. L. *Tetrahedron Lett.* **2000**, *41*, 2839. (k) Agami, C.; Couty, F.; Rabasso, N. *Tetrahedron Lett.* **2000**, *41*, 4113. (l) Guerreiro, P.; Ratovelomanana-Vidal, V.; Genêt, J.-P. *Chirality* **2000**, *12*, 408. (m) Masaki, Y.; Imaeda, T.; Nagata, K.; Oda, H.; Ito, A. *Tetrahedron Lett.* **1989**, *30*, 6393. (n) Ratovelomanana-Vidal, V.; Royer, J.; Husson, H.-P. *Tetrahedron Lett.* **1985**, *26*, 3803.
16. Ruiz, N.; Vicario, J. L.; Badía, D.; Carrillo, L.; Alonso, B. *Org. Lett.* **2008**, *10*, 2613.
17. For a detailed study, see Ref. 3a. For other related examples, see: (a) Zhou, X.-T.; Lu, L.; Furkert, D. P.; Wells, C. E.; Carter, R. G. *Angew. Chem. Int. Ed.* **2006**, *45*, 7622. (b) Robertson, J.; Dallimore, J. W. P.; Meo, P. *Org. Lett.* **2004**, *6*, 3857. (c) White, J. D.; Xu, Q.; Lee, C.-S.; Valeriote, F. A. *Org.*

- Biomol. Chem.* **2004**, *2*, 2092. (d) Vicario, J. L.; Badía, D.; Carrillo, L. *Tetrahedron: Asymmetry* **2003**, *14*, 489. (e) Vicario, J. L.; Badía, D.; Carrillo, L. *Tetrahedron: Asymmetry* **2002**, *13*, 745. (f) Smith, A. B. III; Adams, C. M.; Kozmin, S. A.; Paone, D. V. *J. Am. Chem. Soc.* **2001**, *123*, 5925. See also: (g) Iza, A.; Vicario, J. L.; Badía, D.; Carrillo, L. *Synthesis* **2006**, 4065. (h) Myers, A. G.; Barbay, J. K.; Zhong, B. *J. Am. Chem. Soc.* **2001**, *123*, 7207.
18. $[\alpha]_{\text{D}}^{20} = -3.82$ ($c=0.40$, CHCl_3) for the (-)- β -conhydrine obtained by us; lit. $[\alpha]_{\text{D}}^{20} = -34.10$ ($c=0.40$, CHCl_3). Ref. 15i.
 19. Grubbs, R. H. *Handbook of Metathesis*; Wiley-VCH: Weinheim (Germany), 2003; Vol. 2, p. 10.
 20. $[\alpha]_{\text{D}}^{20} = -22.20$ ($c=0.40$, CHCl_3) for the (-)- β -conhydrine obtained by us; lit. $[\alpha]_{\text{D}}^{20} = -34.10$ ($c=0.40$, CHCl_3). Ref. 15i.
 21. For selected recent reviews on asymmetric organocatalysis, see: (a) Dondoni, A.; Massi, A. *Angew. Chem. Int. Ed.* **2008**, *47*, 4638. (b) Dalko, P. I. *Enantioselective Organocatalysis*; Wiley-VCH: Weinheim, 2007. (c) *Chem. Rev.* **2007**, *107* (12), special issue on organocatalysis. (d) Pellissier, H. *Tetrahedron* **2007**, *63*, 9267. (e) List, B.; Yang, J.-W. *Science* **2006**, *313*, 1584. (f) List, B. *Chem. Commun.* **2006**, 819. (g) Seayad, J.; List, B. *Org. Biomol. Chem.* **2005**, *3*, 719. (h) Dalko, P. I.; Moisan, L. *Angew. Chem. Int. Ed.* **2004**, *43*, 5138. (i) Berkessel, A.; Gröger, H. *Asymmetric Organocatalysis*; VCH: Weinheim, Germany, 2004. (j) *Acc. Chem. Res.* **2004**, *37* (8), special issue on organocatalysis.
 22. For reviews, see: (a) Coldham, I.; Hufton, R. *Chem. Rev.* **2005**, *105*, 2765. (b) Gothelf, K. V.; Jorgensen, K. A. *Chem. Rev.* **1998**, *98*, 863. See also Ref. 1a.
 23. Pandey, G.; Banerjee, P.; Gadre, S. R. *Chem. Rev.* **2006**, *106*, 4484.
 24. For some reviews, see Ref. 1. For some other recent examples not covered by these reviews, see (a) Zeng, W.; Chen, G.-Y.; Zhou, Y.-G.; Li, Y.-X. *J. Am. Chem. Soc.* **2007**, *129*, 750. (b) Dogan, O.; Koyuncu, H.; Garner, P.; Bulut, A.; Youngs, W. J.; Panzner, M. *Org. Lett.* **2006**, *8*, 4687. (c) Bonini, B. F.; Boschi, F.; Comes-Franchini, M.; Fochi, M.; Fini, F.; Mazzanti, A.; Ricci, A. *Synlett* **2006**, 543. (d) Yan, X.-X.; Peng, Q.; Zhang, Y.; Zhang, K.; Hong, W.; Hou, X.-L.; Wu, Y.-D. *Angew. Chem. Int. Ed.* **2006**, *45*, 1979. (e) Stohler, R.; Wahl, F.; Pfaltz, A. *Synthesis* **2005**, 1431. (f) Gao, W.; Zhang, X.; Raghunath, M. *Org. Lett.* **2005**, *7*, 4241. (g) Cabrera, S.; Arrayas, R. G.; Carretero, J. C. *J. Am. Chem. Soc.* **2005**, *127*, 16394. (h) Alemparte, C.; Blay, G.; Jorgensen, K. A. *Org. Lett.* **2005**, *7*, 4569.
 25. Ahrendt, K. A.; Borths, C. J.; MacMillan, D. W. C. *J. Am. Chem. Soc.* **2000**, *122*, 4243.
 26. For some recent applications, see (a) Wilson, R. M.; Jen, W. S.; MacMillan, D. W. C. *J. Am. Chem. Soc.* **2005**, *127*, 11616, and references therein. For other examples, see: (b) Lemay, M.; Ogilvie, W. W. *J. Org. Chem.* **2006**, *71*, 4663. (c) Kano, T.; Tanaka, Y.; Maruoka, K. *Org. Lett.* **2006**, *8*, 2687. (d) Sakakura, A.; Suzuki, K.; Nakao, K.; Ishihara, K. *Org. Lett.* **2006**, *8*, 2229.
 27. (a) Jen, W. S.; Wiener, J. J. M.; MacMillan, D. W. C. *J. Am. Chem. Soc.* **2000**, *122*, 9874. For other examples, see (b) Chow, S. S.; Nevalainen, M.; Evans, C. A.; Johannes, C. W. *Tetrahedron Lett.* **2007**, *48*, 277. (c) Chen, W.; Yuan, X.-H.; Li, R.; Du, W.; Wu, Y.; Ding, L.-S.; Chen, Y.-C. *Adv. Synth. Catal.* **2006**, *348*, 1818. (d) Karlsson, S.; Hogberg, H.-E. *Eur. J. Org. Chem.* **2003**, 2782.
 28. Vicario, J. L.; Reboredo, S.; Badía, L.; Carrillo, L. *Angew. Chem. Int. Ed.* **2007**, *46*, 5168.
 29. Grigg, R. *Chem. Soc. Rev.* **1987**, *16*, 89.
 30. Grigg, R.; Donegan, G.; Guranatne, H. Q. N.; Kennedy, D. A.; Malone, J. F.; Sridharan, V.; Thianpatanagul, S. *Tetrahedron* **1989**, *45*, 1723.
 31. Chen, C.; Li, X.; Schreiber, S. L. *J. Am. Chem. Soc.* **2003**, *125*, 10174.
 32. Xie, X. W.; Yue, L.; Xue, D.; Ma, X.-L.; Chen, Y. C.; Wu, Y.; Zhu, J.; Deng, J.-G. *Chem. Commun.* **2006**, 1563. See also Ref. 27c.
 33. For some reviews, see: (a) Vicario, J. L.; Badía, D.; Carrillo, L. *Synthesis* **2007**, 2065. (b) Almaçı, D.; Alonso, D. A.; Najera, C. *Tetrahedron: Asymmetry* **2007**, *18*, 299. (c) Tsogoeva, S. B. *Eur. J. Org. Chem.* **2007**, 1701. (d) Sulzer-Mosse, S.; Alexakis, A. *Chem. Commun.* **2007**, 3123.
 34. For a general review on Michael additions to nitroalkenes, see: Berner, O. M.; Tedeschi, L.; Enders, D. *Eur. J. Org. Chem.* **2002**, 1877.
 35. For some examples, see: (a) Wiesner, M.; Revell, J. D.; Wennemers, H. *Angew. Chem. Int. Ed.* **2008**, *47*, 1871. (b) Chi, Y.; Guo, L.; Kopf, N. A.; Gellman, S. H. *J. Am. Chem. Soc.* **2008**, *130*, 5608. (c) Wiesner, M.; Revell, J. D.; Tonazzi, S.; Wennemers, H. *J. Am. Chem. Soc.* **2008**, *130*, 5610. (d)

- McCooey, S. H.; Connon, S. J. *Org. Lett.* **2007**, *9*, 599. (e) Barros, M. T.; Phillips, A. M. F. *Eur. J. Org. Chem.* **2007**, 178. (f) Diez, D.; Gil, M. J.; Moro, R. F.; Marcos, I. S.; Garcia, P.; Basabe, P.; Garrido, N. M.; Broughton, H. B.; Urones, J. G. *Tetrahedron* **2007**, *63*, 740. (g) Albertshofer, K.; Thayumanavan, R.; Utsumi, N.; Tanaka, F.; Barbas, C. F. III *Tetrahedron Lett.* **2007**, *48*, 693. (h) Palomo, C.; Vera, S.; Mielgo, A.; Gomez-Bengoa, E. *Angew. Chem. Int. Ed.* **2006**, *45*, 5984. (i) Mase, N.; Watanabe, K.; Yoda, H.; Takabe, K.; Tanaka, F.; Barbas, C. F. III *J. Am. Chem. Soc.* **2006**, *128*, 4966. (j) Mosse, S.; Alexakis, A. *Org. Lett.* **2006**, *8*, 3577. (k) Mosse, S.; Laars, M.; Kriis, K.; Kanger, T.; Alexakis, A. *Org. Lett.* **2006**, *8*, 2559. (l) Zu, L.; Li, H.; Wang, J.; Yu, X.; Wang, W. *Tetrahedron Lett.* **2006**, *47*, 5131. (m) Zu, L.; Wang, J.; Li, H.; Wang, W. *Org. Lett.* **2006**, *8*, 3077. (n) Xu, D.; Luo, S.; Yue, H.; Wang, L.; Xu, Z. *Synlett* **2006**, 2569. (o) Li, Y.; Liu, X.-Y.; Zhao, G. *Tetrahedron: Asymmetry* **2006**, *17*, 2034. (p) Enders, D.; Hüttel, M. R. M.; Grondal, C.; Raabe, G. *Nature*, **2006**, *441*, 861. (q) Hayashi, Y.; Gotoh, H.; Hayashi, T.; Shoji, M. *Angew. Chem. Int. Ed.* **2005**, *44*, 4212. (r) Wang, W.; Wang, J.; Li, H. *Angew. Chem. Int. Ed.* **2005**, *44*, 1369. (s) Betancort, J. M.; Sakthivel, K.; Thayumanavan, R.; Tanaka, F.; Barbas, C. F. III *Synthesis* **2004**, 1509. (t) Mase, N.; Thayumanavan, R.; Tanaka, F.; Barbas, C. F. III *Org. Lett.* **2004**, *6*, 2527. (u) Andrey, O.; Alexakis, A.; Tomassini, A.; Bernardinelli, G. *Adv. Synth. Catal.* **2004**, *346*, 1147. (v) Betancort, J. M.; Barbas, C. F. III *Org. Lett.* **2001**, *3*, 3737.
36. Ono, N. *The Nitro Group in Organic Chemistry*; Wiley-VCH: Weinheim, Germany, 2005.
37. Andrey, O.; Vidonne, A.; Alexakis, A. *Tetrahedron Lett.* **2003**, *44*, 7901; see also Ref. 35u.
38. (a) Ruiz, N.; Reyes, E.; Vicario, J. L.; Badía, D.; Carrillo, L.; Uria, U. *Chem. Eur. J.* **2008**, *14*, 9357. For an overview on the use of this kind of *O*-silylated diarylprolinol amines as organocatalysts, see (b) Palomo, C.; Mielgo, A. *Angew. Chem. Int. Ed.* **2006**, *45*, 7876. For the first examples using this kind of organocatalysts, see (c) Hayashi, Y.; Gotoh, H.; Hayashi, T.; Shoji, M. *Angew. Chem. Int. Ed.* **2005**, *44*, 4212. (d) Marigo, M.; Wabnitz, T. C.; Fielenbach, D.; Jorgensen, K. A. *Angew. Chem. Int. Ed.* **2005**, *44*, 794.
39. For a paper highlighting this subject, see Ref. 35h.
40. Seebach, D.; Golinski, J. *Helv. Chim. Acta* **1981**, *64*, 1413.
41. The lower yields of the final pyrrolidines obtained in some cases can be attributed to the fact that single diastereoisomers were obtained starting from mixtures of *cis/trans* precursors which indicated that the minor diastereoisomer was removed during the reaction or the purification of the final product.
42. Reaction of nitroaldehyde **38a** with Zn at r.t. furnished pyrrolidine **41a** as a 4:1 mixture of diastereoisomers as a result of partial epimerization of C4. This side reaction was avoided by carrying out the reaction at -15 °C and therefore obtaining **41a** as a single diastereoisomer.

SYNTHESIS OF PHOSPHORUS-SUBSTITUTED SULFUR HETEROCYCLES

Mihaela Gulea and Annie-Claude Gaumont

*Laboratoire de Chimie Moléculaire et Thio-Organique (LCMT), ENSICAEN, Université de Caen Basse-Normandie, CNRS, 6 Boulevard du Marechal Juin, F-14050 Caen, France
(e-mail: mihaela.gulea@ensicaen.fr)*

Abstract. *The existing procedures enabling to synthesize phosphoro-substituted heterocycles containing only one sulfur atom are reviewed.*

Contents

1. Introduction
2. Syntheses by phosphorylation of a sulfur heterocycle
 - 2.1. Syntheses using phosphorus nucleophiles
 - 2.1.1. Arbuzov-type reactions
 - 2.1.2. Metal-catalyzed P–C coupling reactions
 - 2.1.3. Nucleophilic additions of di- or trialkylphosphites
 - 2.1.4. Pummerer-type reactions
 - 2.2. Syntheses using phosphorus electrophiles
3. Syntheses involving the formation of the sulfur heterocycle
 - 3.1. Cycloaddition reactions
 - 3.1.1. [4+2] Cycloadditions
 - 3.1.1.1. With phosphorylated thiocarbonyl compounds as dienophiles
 - 3.1.1.1.1. Phosphinoyl thioaldehydes
 - 3.1.1.1.2. Phosphonodithioformates
 - 3.1.1.1.3. Phosphoryl-substituted sulfines
 - 3.1.1.2. With phosphorylated thiocarbonyl compounds as dienes
 - 3.1.2. [3+2] Cycloadditions
 - 3.2. Syntheses based on intramolecular cyclizations
 - 3.2.1. Carbanion mediated cyclizations
 - 3.2.2. Carbenoid mediated cyclizations
 - 3.2.3. Radical mediated cyclizations
 - 3.2.4. Electrocyclizations
 - 3.2.4.1. 1,3-Dipolar electrocyclizations
 - 3.2.4.2. Domino Knoevenagel/1,6-heteroelectrocyclizations
 - 3.3. Miscellaneous
 - 3.3.1. Sigmatropic rearrangements
 - 3.3.1.1. [2,3]-Sigmatropic rearrangement
 - 3.3.1.2. [1,3]-Sigmatropic rearrangement
 - 3.3.2. Ring-closing metathesis

4. Conclusion

Acknowledgments

References

1. Introduction

Sulfur and phosphorus containing compounds have attracted considerable attention these last years because of their interesting properties and applications. They found use in the field of hybrid organic/inorganic materials, as ligands for homogeneous catalysis and as intermediates for the synthesis of analogues of biologically active compounds. Reviews dealing with such compounds, in which a phosphoryl group is associated to a sulfur moiety such as a thiol, a sulfide, a sulfoxide or a dithioester, have already been published.^{1,2} As a complement, this non exhaustive review focuses on the synthesis of a different type of phosphorus-substituted sulfur heterocycles containing only one sulfur atom (Figure 1). In these compounds, the phosphorous function refers to phosphonates, phosphine oxides and phosphines. The sulfur heterocycles (three to eight membered rings) highlighted in this review can be saturated, unsaturated, or aromatic (for example: thiirane, thiolane, thiophene, thiopyrane, etc...). In the major cases, the phosphorus and the sulfur atoms are in vicinal position. In this contribution, we wish to emphasize on the methodologies enabling their synthesis. However, when the obtained compounds are of synthetic, biological or physical relevance, their applications will also be mentioned. Cited references are restricted to journals, reviews and books. Literature coverage for this contribution extends up to May 2008. The classification is based on the methodology used to produce the phosphorus-substituted sulfur heterocycle. First methodologies involving the introduction of the phosphorus moiety on the sulfur heterocycle *via* phosphorus nucleophiles then phosphorus electrophiles will be depicted. Then, methodologies which involve the formation of the sulfur heterocycle using cycloadditions or intramolecular cyclisations will be developed.

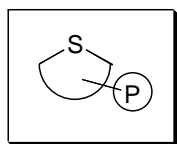

Figure 1

2. Syntheses by phosphorylation of a sulfur heterocycle

2.1. Syntheses using phosphorus nucleophiles

2.1.1. Arbuzov-type reactions

In the late seventies, the Arbuzov reaction was used to prepare phosphorus-substituted thiolanes. The reaction of 2-chlorotetrahydrothiophene **1** with either triethylphosphite or ethyl diphenylphosphinite under conditions showed in Scheme 1, yielded phosphonate **2** and phosphine oxide **3**, respectively.³

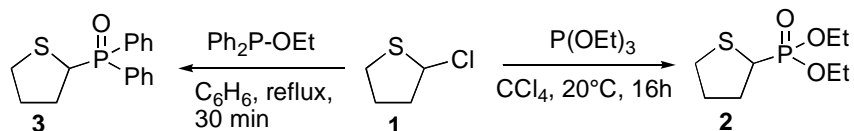

Scheme 1

Compound **2**, although formed in high amount in the crude reaction mixture (80% by ^{31}P NMR), is obtained in low yield, because of partial decomposition under distillation conditions.

2.2. Metal-catalyzed P–C coupling reactions

The P–C bond formation between trialkylphosphites and sulfur heterocyclic halides is promoted by transition metals such as Pd(II) or Ni(II). Reaction between triethylphosphite and 2- or 3-bromothiophene **4** was accomplished using NiCl_2 as catalyst (Scheme 2).⁴ The resulting thienylphosphonates **5** were hydrolyzed into their phosphonic acid derivatives **6**, which were used to prepare layered zinc phosphonates as hybrid organic-inorganic materials.⁴

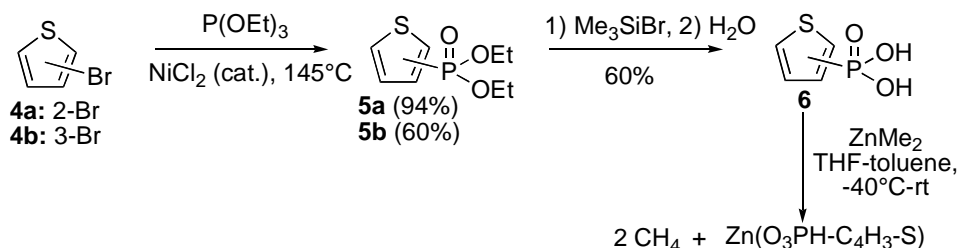

Scheme 2

Branched oligothiophene phosphonic acids **P3T** and **P7T** (Figure 2) were obtained from the corresponding phosphonates, previously formed by NiBr_2 -catalyzed reaction of triethylphosphite with the corresponding 2-bromothiophene derivatives.⁵ These compounds were used as electroactive surfactants for the capping of cadmium selenide (CdSe) nanoparticles.⁵

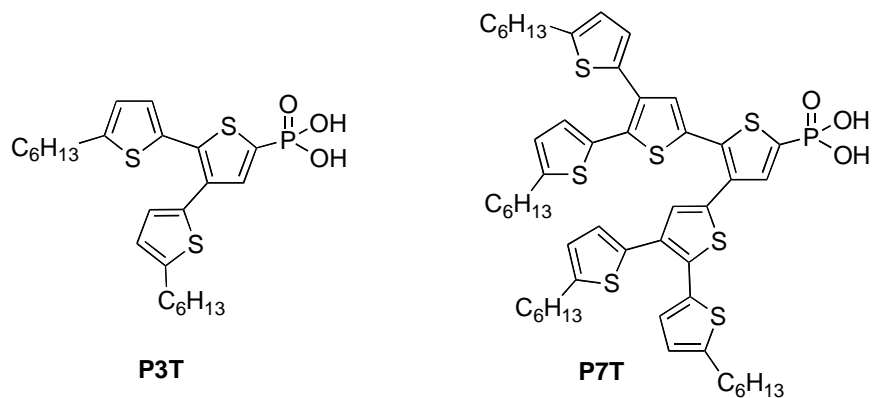
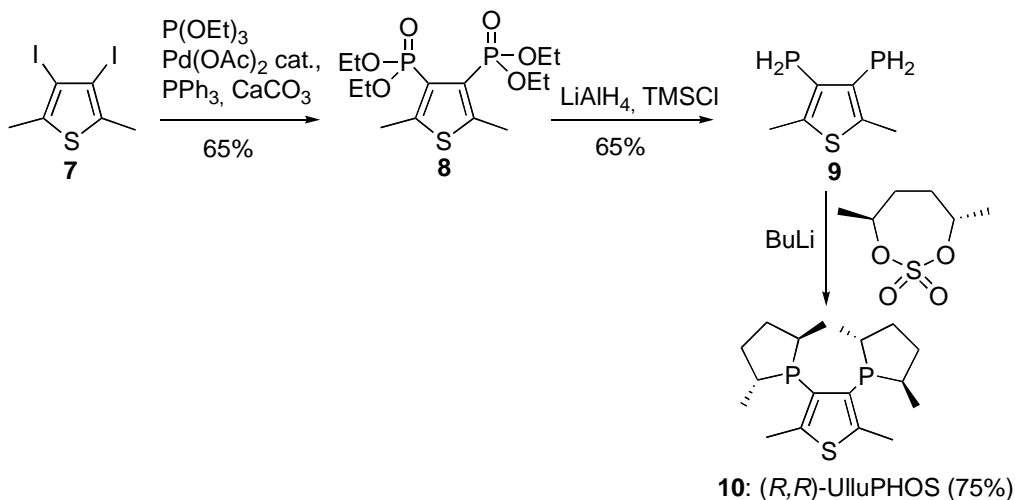

Figure 2

A thiophene analogue of Me-DuPHOS ligand, named UlluPHOS, has been synthesized in three steps, as shown in Scheme 3. The two C–P bonds were formed in the first step by reacting 3,4-diiodo-2,5-dimethyl thiophene **7** with two equiv. of triethylphosphite, under Pd(OAc)_2 catalysis.⁶ UlluPHOS **10** was compared to Me-DuPHOS in the Rh(I)-catalyzed hydrogenation of *N*-acetyl- α -enamino acids. An excellent enantioselectivity (up to 98%) and an activity higher than that of Me-DuPhos were obtained with the sulfur heterocyclic ligand.

Other thiophene and benzothiophene bearing diphenylphosphinyl groups and functionalized by an enantiopure *trans*-1,2-diaminocyclohexane backbone as in **13** (Scheme 4) have been used as chiral ligands in the asymmetric allylation of catechol. In these structures, the P–C bond was previously formed by Pd-catalysed coupling between the bromothiophene derivative **11** and diphenylphosphine (Scheme 4).⁷



Scheme 3

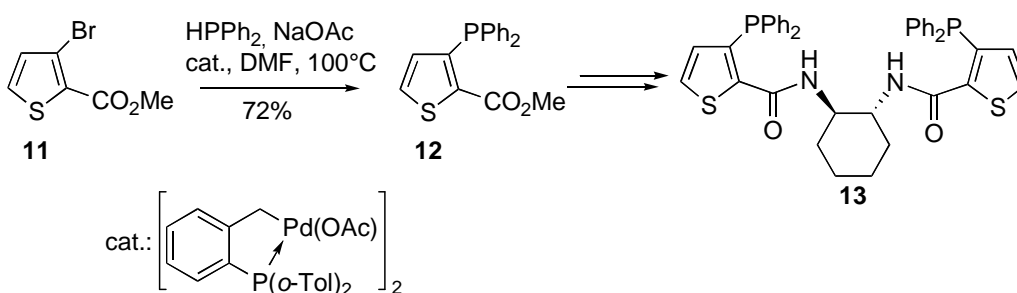

Scheme 4

2.1.3. Nucleophilic additions of di- or trialkylphosphites

Cyclic α -amino phosphonates were efficiently prepared in a one-pot reaction by nucleophilic addition of triethyl phosphite to the C=N bond of an imine, initially formed from an amine and a cyclic ketone.⁸ Among these compounds, three thiopyran derivatives **15a–c** were synthesised from 4-thiopyranone **14** (Scheme 5).

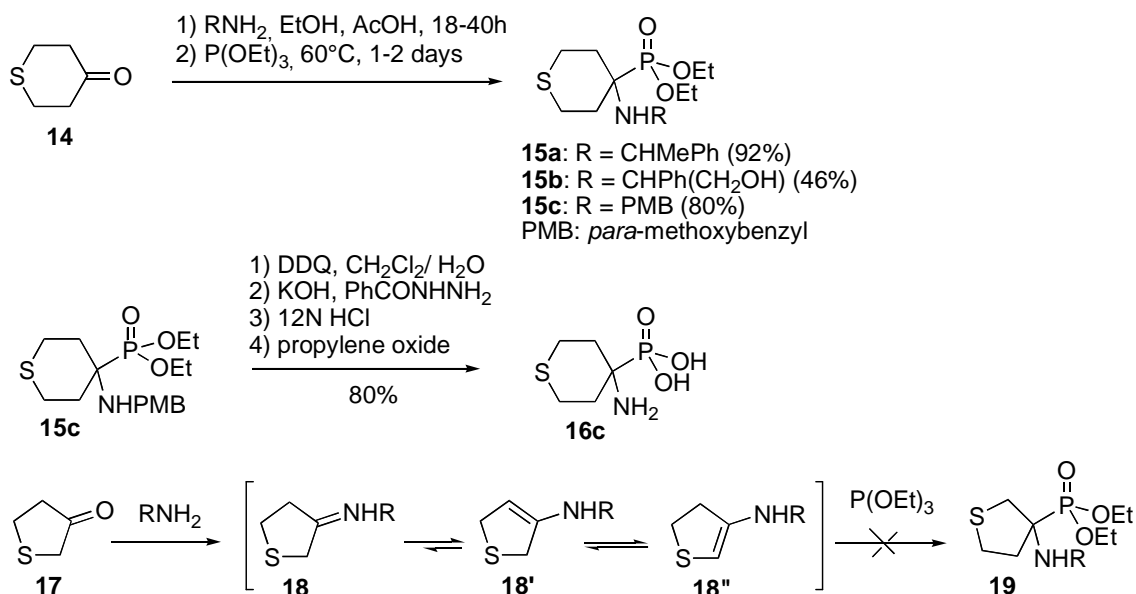

Scheme 5

Attempts to form the corresponding free amine, from compound **15b** (or from its sulfoxide derivative) failed under classical deprotection conditions [H_2 , $\text{Pd}(\text{OH})_2/\text{C}$]. In contrast, free amino phosphonic acid **16c** was obtained from compound **15c** using DDQ to perform the NH-PMB cleavage. This reaction, however, did not work in the 3-thiocyclopentanone series (**17**), as the imine intermediate **18** undergoes a double bond migration leading to the more stable enamines **18'** and **18''**, which are in equilibrium.

β -Ketophosphonates can be prepared by 1,4-addition of a phosphite to an α,β -unsaturated ketone. For cyclic ketones, because of a lower reactivity compared to the acyclic derivatives, a facile method using mild reaction conditions was developed.⁹ The phosphorus nucleophile used is dialkyl trimethylsilyl phosphite **21**, which is prepared *in situ* from dialkylphosphite **20** and *N,O*-bis(trimethylsilyl)acetamide (BSA) in the presence of a catalytic amount (5% mol) of trimethylsilyl triflate (Scheme 6). Upon reacting **21** with sulfur heterocyclic cyclohexenone **22**, the expected adducts **23** were obtained in moderate to reasonable yields (58 to 72%).

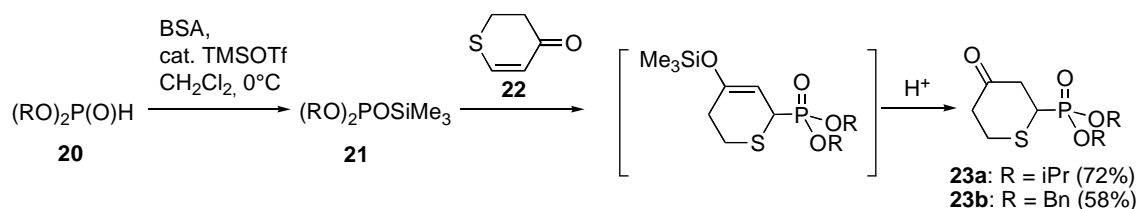

Scheme 6

Phosphite anion **25** reacted with 2-silatranylthiophene manganese cation **24** in the 5-position afford manganese phosphonothiothiophene tricarbonyl complex **26** (Scheme 7).¹⁰ The molecular structure of the obtained complex was determined by X-ray study.

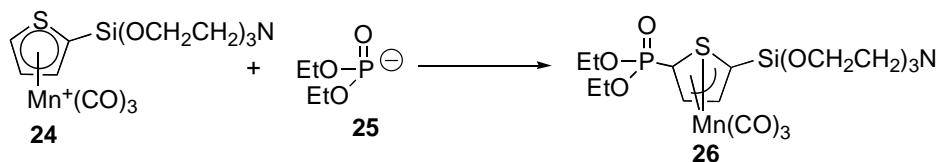

Scheme 7

Reaction of trimethylphosphite (**27**) with 3,4-dihydro-2*H*-thiopyran **28** in anhydrous ether and in the presence of dry HCl gave dimethyl tetrahydrothiopyran-2-yl phosphonate (**29**) in excellent yield (92%) (Scheme 8).¹¹

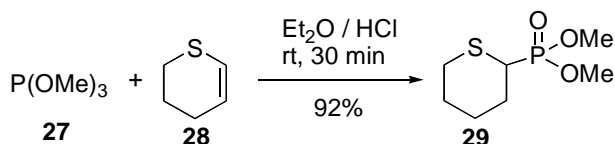

Scheme 8

2.1.4. Pummerer-type reaction

The first example using phosphorus as a nucleophile in a Pummerer-type reaction was described by Masson *et al.*¹² The reaction of trialkylphosphite nucleophiles with thiolane *S*-oxide (**30**) led to

phosphorylated thiolanes **31a–e** (Scheme 9). Yields depend on the nature of the phosphite ‘R’ group. The proposed mechanism involves subsequent Pummerer (steps 1 and 2) and Arbuzov (step 3) reactions. The method seemed to be restricted to the five-membered sulfur derivatives, as with the six-membered cyclic sulfoxides, as well as with dimethyl sulfoxide and phenyl methyl sulfoxide, all attempts failed to deliver sulfanyl phosphonate product under similar conditions.

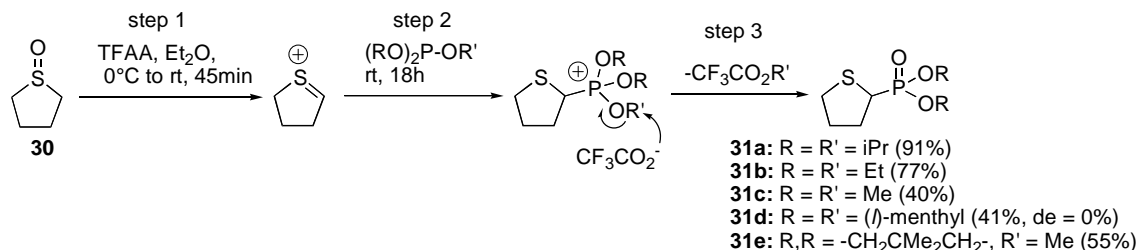

Scheme 9

Several studies on the reactivity of phosphonothiolanes such as **31** have been carried out in collaboration between our group and a Polish group.^{13,14} The *S*-oxidation of these compounds into the corresponding sulfoxides **32** took place with a total *trans*-selectivity whatever the oxidant used (NaIO₄, mCPBA, or a chiral oxaziridine).^{13,14} Selected results obtained in the asymmetric version with phosphonothiolane **31d** are given in Scheme 10. Oxidation with 0.5 equiv. of (+)-(2*S*,8*aR*)-8,8-dichloro-camphorsulfonyloxaziridine under kinetic resolution conditions afforded sulfoxide **32d** with 25% ee.¹³ Sulfoxide **32d** was transformed *via* a Pummerer reaction into the unsaturated sulfide **33d**, which was oxidized with one equiv. of the same enantiopure oxaziridine, leading to the corresponding α,β -unsaturated sulfoxide **34d** with 70% ee. After several crystallizations, the major (+)-enantiomer was isolated and characterized by X-ray diffraction analysis, which enabled to determine the absolute configuration of the sulfur atom to be (*S*).¹³

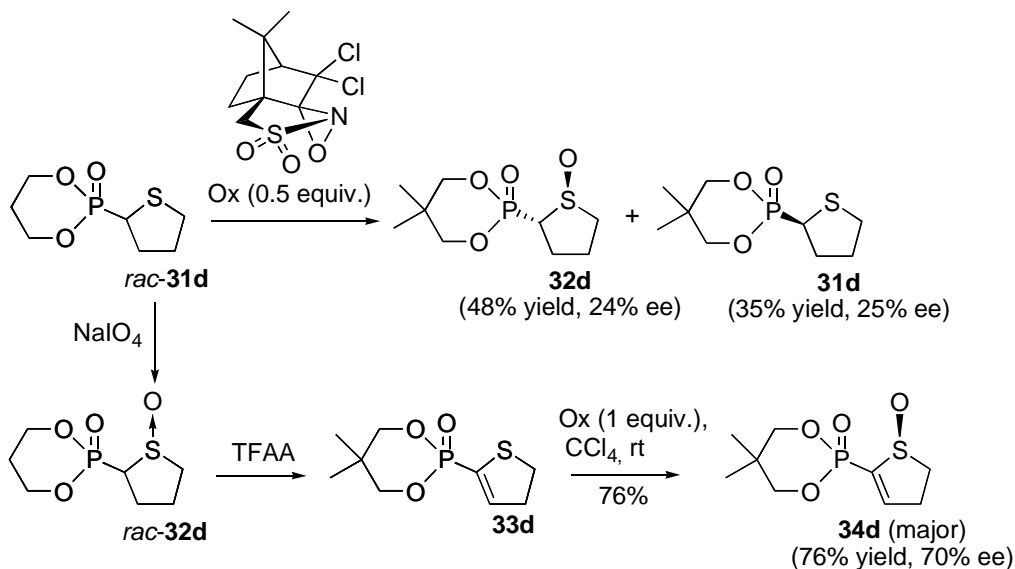

Scheme 10

In another study, the same authors prepared sulfoxide **34d** in racemic form and used it as a Michael acceptor.¹⁴ Probably due to the particular geometry of the substrate (unsaturated 5-membered heterocycle),

the reactions were fully diastereoselective in most of the cases. As an example, products **35d** and **36d** obtained by reaction with thiophenol and aniline, have been obtained as a single diastereomer in good yields (Scheme 11).

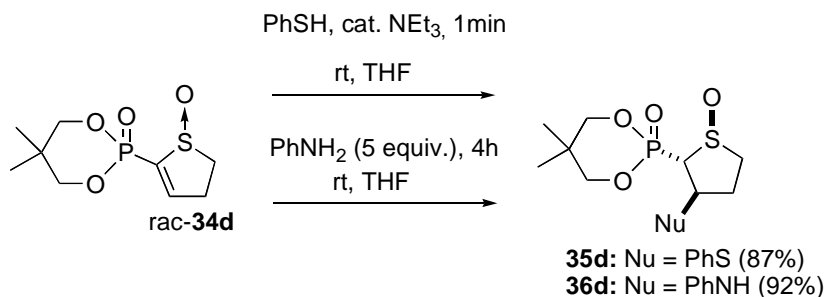

Scheme 11

2.2. Syntheses using phosphorus electrophiles

Reaction of α -lithiated thiolane *S*-oxide (**37**) with chlorodiphenylphosphine led to phosphine sulfoxide **38**, as a single *trans*-diastereomer (Scheme 12).¹⁵ This compound shows a great stability, as the expected oxygen transfer from the sulfinyl to the phosphorus atom is very slow (5 h) even in the presence of 0.2 equiv. of iodine. Treated with potassium *tert*-butoxide, *trans*-**38** exists in an equilibrium with *cis*-isomer **38'**, which in turn, is converted in a few minutes under similar conditions (0.2 equiv. I₂) into phosphine oxide **39**.

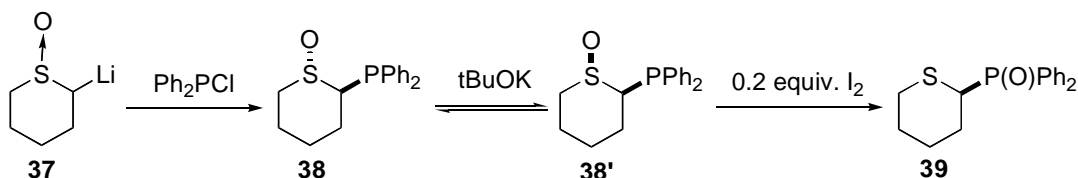

Scheme 12

2-(Diphenylphosphinoyl)-4-*tert*-butyl-tetrahydrothiopyran *S*-oxide (**41**) was prepared by reaction of the lithiated thiopyran *S*-oxide **40** with chlorodiphenylphosphine and subsequent P-oxidation. The corresponding *S*-deoxygenated derivative **42** was also studied in order to analyze the conformational preference of the phosphinoyl group and the anomeric effect in this kind of structures (Scheme 13).¹⁶

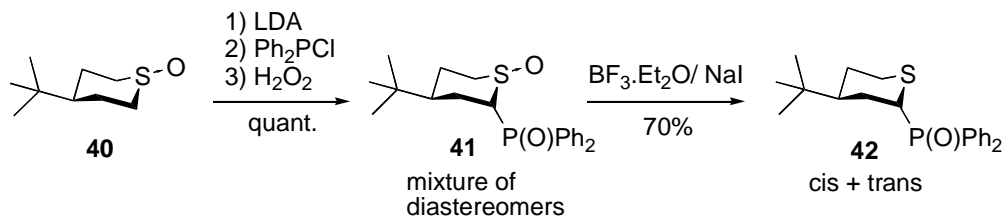

Scheme 13

Various structures containing thiophen heterocycle substituted in the adjacent position to the sulfur atom with a diphenyl phosphinyl group have been synthesized as ligands for metal-catalyzed reactions. The main synthetic methods consist in α -lithiation of the thiophene moiety followed by reaction with chlorodiphenylphosphine oxide¹⁷ (Scheme 14) or chlorodiphenylphosphine¹⁸ (Scheme 15), respectively.

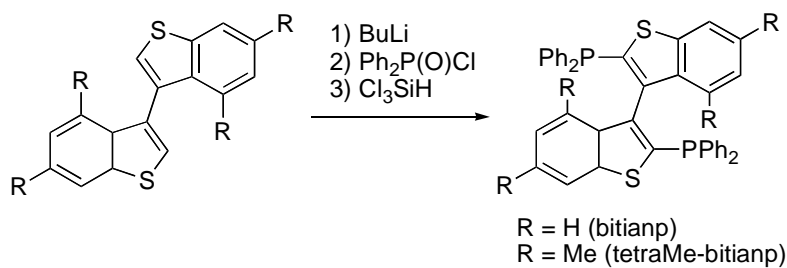

Scheme 14

In the first case, the additional reduction of the phosphine oxide into phosphine is required to afford the ligand. Bitianp derivatives were used as ligands in Ru(II)-catalyzed hydrogenation of α - and β -oxo esters and found to be as efficient as the popular BINAP ligand, with the advantage of an easier synthetic access.¹⁷



Scheme 15

In tetraMe-BITIOP ligand (Figure 3), the thiophen heterocycles bearing a phosphinyl group in the 4-position have been synthesized from the corresponding 4-bromo derivative by halogen-lithium exchange and subsequent reaction with chlorodiphenylphosphine.¹⁹ This ligand was successfully used in Ru(II)- and Rh(I)-catalyzed hydrogenation of functionalized carbonyl and olefinic substrates.

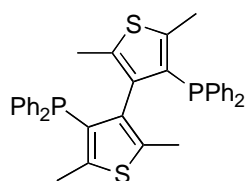
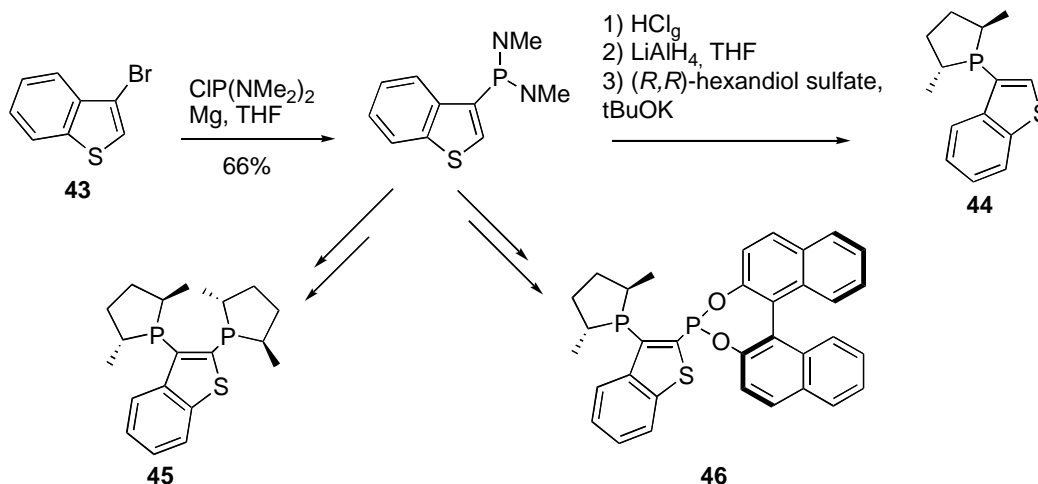

Figure 3



Scheme 16

Benzothiophene has been functionalized in the 3- or in both the 2- and 3-positions to access monophospholane **44**, bis(phospholane) **45** and phospholane-phosphinite **46** (Scheme 16).²⁰ The C–P bond in these compounds was formed by reaction of the Grignard reagent derived from 3-bromothiophene (**43**) with chlorobis(dimethylamino)phosphane. The obtained ligands showed a great efficiency in the Rh(I)-catalyzed hydrogenation of enamides.

3. Syntheses involving the formation of the sulfur heterocycle

3.1. Cycloaddition reactions

Thermal [4+2] and [3+2] cycloadditions, which involve a reactant containing a thiocarbonyl group (*i.e.* thioaldehydes, thioketones, dithioesters) represent straightforward and atom-economic methods for the formation of sulfur heterocycles. The thiocarbonyl function is strongly activated by an electron-withdrawing group and for this reason phosphorylated thiocarbonyl compounds are very efficient dienophiles and dipolarophiles. The thiocarbonyl group can also be part of the diene or the 1,3-dipole partner.

3.1.1. [4+2] Cycloadditions

3.1.1.1. With phosphorylated thiocarbonyl compounds as dienophiles

3.1.1.1.1. Phosphinoyl thioaldehydes

Diphenylphosphinoyl thioformaldehyde (**48**) was formed by photofragmentation of phenacyl sulfide precursor **47** and trapped with an electron-rich diene (Scheme 17) leading to **49** in good yield (75%). In agreement with the expected regioselectivity of the reaction with an acceptor-substituted thioaldehyde, regioisomer **49** was formed exclusively.²¹

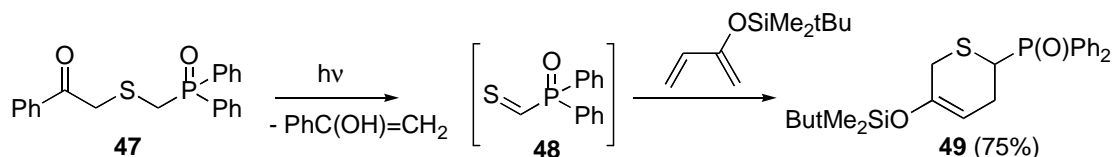

Scheme 17

3.1.1.1.2. Phosphonodithioformates

It is well established that thiocarbonyl compounds such as thioaldehydes, thioketones, or dithioesters can react as dienophilic partners in hetero-Diels-Alder (HDA) reactions.²² Among these compounds, phosphorylated dithioesters are very efficient heterodienophiles, due to the electron withdrawing effect of the phosphoryl group, which lowers the LUMO of the thiocarbonyl group.^{23–25}

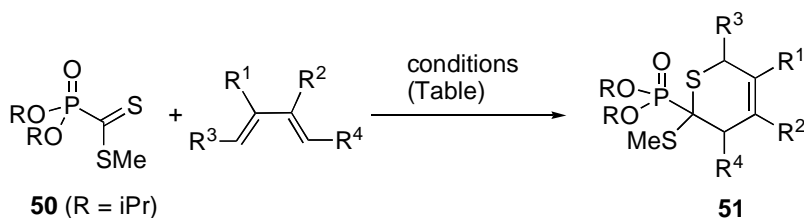

Scheme 18

Cycloaddition between diisopropyl phosphonodithioformate (**50**) and nonfunctionalized or functionalized dienes allowed preparing various phosphorylated 3,6-dihydro-2-methylthio-2*H*-pyrans of type **51** in good yields (Scheme 18, Table 1).

In most of the cases, these reactions take place slowly at room temperature, but can be accelerated thermally (Table 1, entries 7 and 9) or under microwave irradiation (entry 8). The most significant result was however the activation of the dienophile by a Lewis acid (LA) such as ZnCl₂ or BF₃·Et₂O, in stoichiometric (entries 2 and 10) or in catalytic amount (entry 4). The LA is presumably chelated to the oxygen of the phosphoryl group, increasing its electron-withdrawing effect and therefore accelerating the HDA reaction.

Table 1. Selected examples of the reaction between phosphonodithioformate **50** and dienes.

Entry	R ¹	R ²	R ³	R ⁴	Reaction conditions	Product	Ratio <i>endo/exo</i>	Yield %	Ref.
1	H	H	H	H	rt, 24h ^{a,b}	2a	-	95	23
2	H	H	H	H	1 equiv. ZnCl ₂ , rt, 2h ^{a,b}	51a	-	99	25
3	Me	Me	H	H	rt, 24h	51b	-	93	23
4	Me	Me	H	H	0.1 equiv. BF ₃ , rt, 5min ^{a,b}	51b	-	95	23
5	Me	H	H	H	rt, 24h ^b	51c ^c	-	93	23
6	H	H	CH ₂		rt, 1h ^b	51d	7/3	90	23
7	H	H	OAc	OAc	50 °C, 168h ^d	51e	2/1	87	24, 25
8	H	H	OAc	OAc	MW, 20min ^d	51e	1/1	70	25
9	H	H	H	SPh	50 °C, 12h ^d	51f	1/1	95	25
10	H	H	H	OH	1 equiv. BF ₃ , rt, 18h ^d	51g	3/1 ^e	90	25

^aReaction in a pressure tube. ^bReaction in 5 mL of CH₂Cl₂ for 2.4 mmol of dithioester and 5 equiv. of diene. ^cMixture of 2 regioisomers in a 2:3 ratio. ^dReaction in 5 mL of THF for 2.4 mmol of dithioester and 2 equiv. of diene. ^eAdduct **2g** is obtained in the desilylated form, from the diene having R⁴=OSiMe₃

Some of the HDA adducts have been used as precursors for the synthesis of both phosphorylated thiaglycoside structures²⁵ and *P,S*-analogues of the shikimic acid.^{24,25} As an example, the sequence for the preparation of the latter starting from adduct **51e** is given in Scheme 19. It involves as key steps the selective radical desulfanylation, the *cis*-dihydroxylation and the formation of the double bond in alpha position to the phosphoryl group.

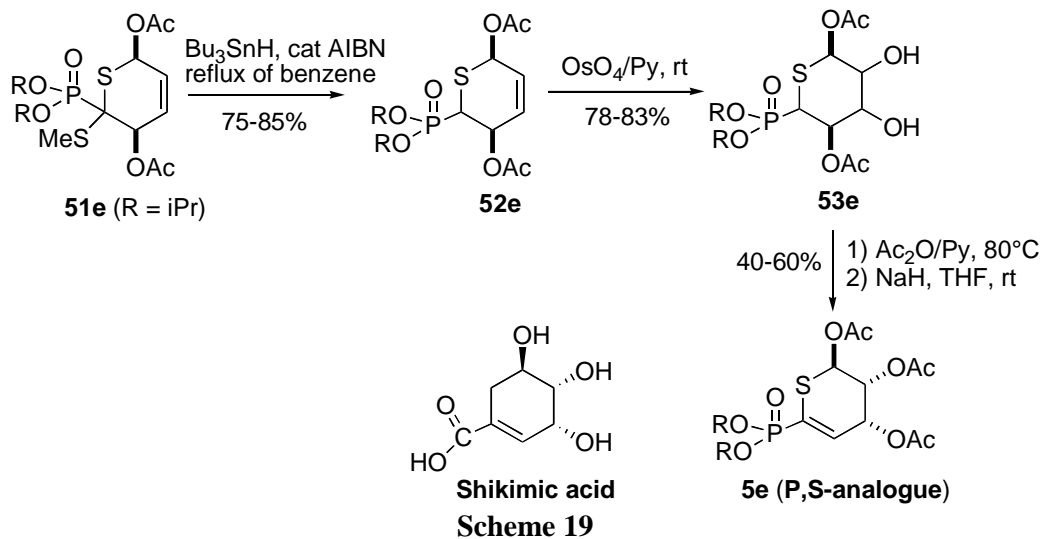

In a recent study, HDA adducts **51a** and **51b** have been used as substrates for sulfoxidation and subsequent Pummerer reaction (Scheme 20).²⁶ The oxidation took place almost selectively on the endocyclic sulfur atom and the Pummerer reaction proceeded *via* a regioselective attack of the nucleophile at the γ -position of the thionium ion intermediate, to give either products **55** or a mixture of **56** and **57**, respectively.

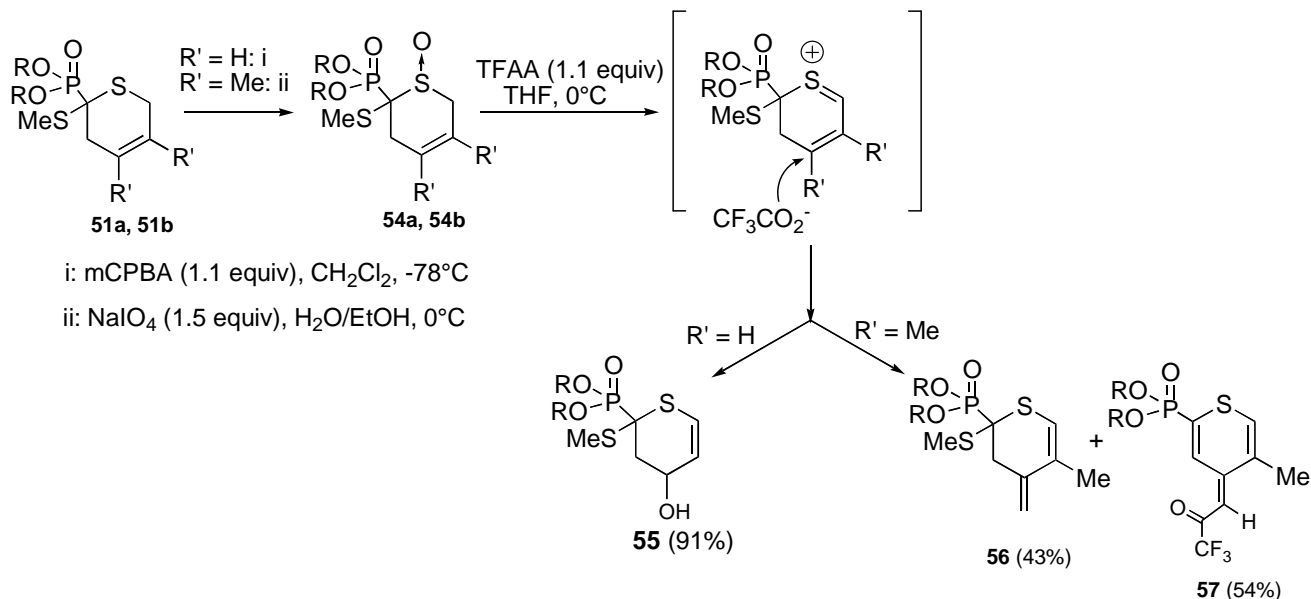

Scheme 20

3.1.1.1.3. Phosphoryl-substituted sulfines

Sulfines, compounds in which the sulfur atom of the thiocarbonyl group is oxidized, are rather unstable species, which are often trapped *in situ* as synthetic intermediates. Phosphoryl-substituted sulfines are more stable compounds because of the electron-withdrawing effect induced by the phosphoryl group. Sulfines **58** (obtained by a modified Peterson reaction from an α -silylated phosphonate and sulfur dioxide) could be isolated and then involved in Diels-Alder reactions with the 2,3-dimethylbutadiene to yield the corresponding cycloadducts **59** (Scheme 21).²⁷

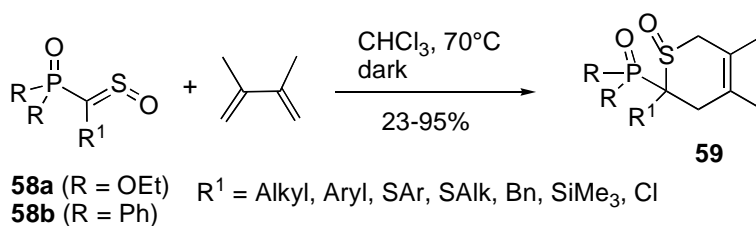

Scheme 21

Sulfine **60** (generated from cyanomethylphosphonate and thionyl chloride in the presence of triethylamine) have been trapped *in situ* by 1,3-butadiene, leading to cycloadduct **61**.²⁸ The latter was deoxygenated using trifluoroacetic anhydride/sodium iodide reduction conditions. The resulting phosphorylated dihydrothiopyran **62** was involved in a ring-contraction, using *N*-iodosuccinimide in the presence of a carboxylic acid, leading to phosphorylated thiolanes **63**, which were obtained as an equimolecular mixture of two isomers (Scheme 22).

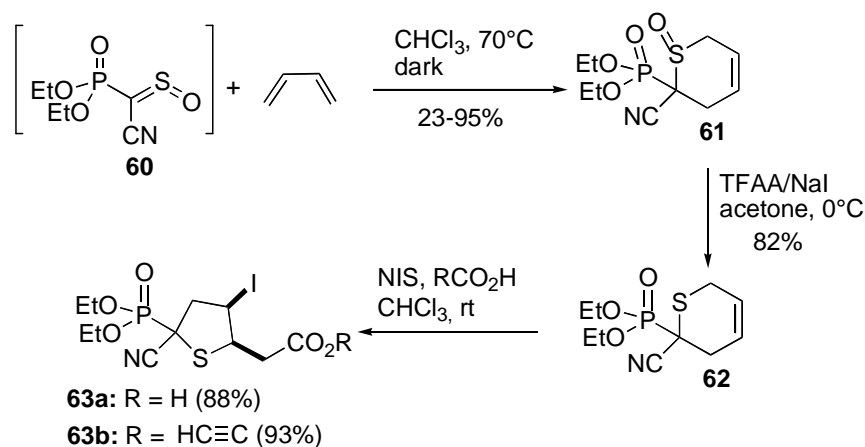

Scheme 22

3.1.1.2. With phosphorylated thiocarbonyl compounds as dienes

Phosphorylated thiocarbonyl containing heterodienes **65** have been synthesized by a totally *E*-stereoselective Knoevenagel reaction from triethyl phosphonodithioacetate **64** and aromatic or heteroaromatic aldehydes (or their amins). They have been used in the reverse-electron demand hetero-Diels-Alder reactions with vinyl-ethers or -thioethers yielding phosphono-substituted dihydrothiopyrans **66** (Scheme 23).^{29,30} Interestingly, an inversion of the stereoselectivity of the reaction is observed depending on the conditions of the reaction. Under thermal conditions (at 125 °C), the *exo*-approach of the dienophile is favoured leading to the *trans* cycloadduct, while under hyperbaric conditions (under 11 kbar), the *endo*-approach is favored yielding mainly the *cis* cycloadduct. Moreover, under high pressure, if one equivalent of pyridine was added to the reaction mixture, the stereocontrol of the cycloaddition switched again in favour of the *trans* cycloadduct.²⁹

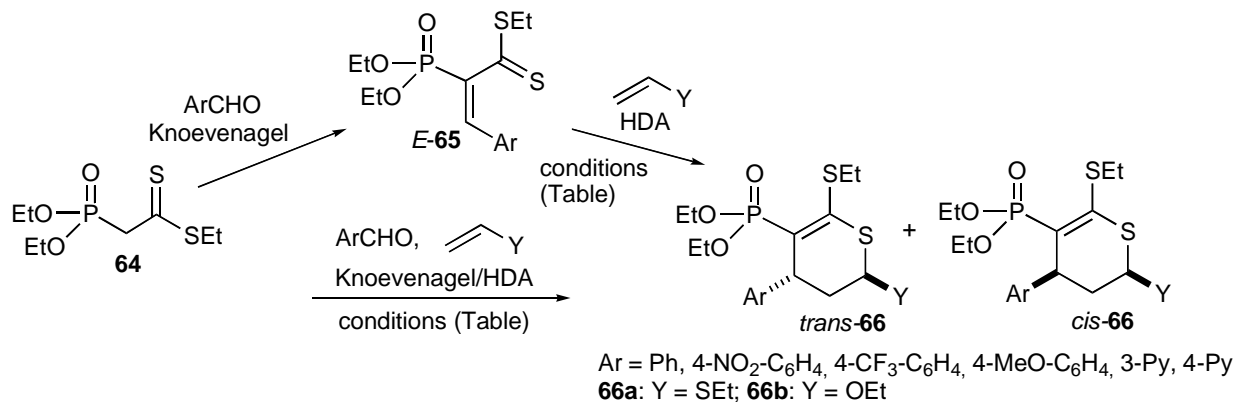

Scheme 23

This was explained by an *in-situ* *E* → *Z* isomerisation of the heterodiene (*via* the Michael-adduct obtained by addition of pyridine to the *E*-heterodiene) and a higher reactivity of the resulting *Z* isomer. The authors also showed that phosphono-substituted dihydrothiopyran **66** could be obtained in a one-pot synthesis from triethyl phosphonodithioacetate **64**, the suitable aldehyde and the electron-rich dienophile, through a domino Knoevenagel/hetero-Diels-Alder sequence (Scheme 23).³⁰ Yields were in this case higher than using the two-steps sequence and selectivities similar to that obtained in the separate cycloadditions performed under thermal conditions.

Table 2. Selected examples of the formation of products **66** with Ar = 4-NO₂-C₆H₄.

Entry	Y	Reaction conditions ^a	Product	Ratio		Yield %	Ref.
				<i>trans/cis</i>			
1 ^b	SEt	pressure tube, 125 °C, 6h	66a	7/93	89 ^d (78) ^e	29	
2 ^b	SEt	11 kbar, 20 °C, 48h	66a	86/14	83 ^d	29	
3 ^b	SEt	11 kbar, 20 °C 48h, 1 equiv. Py	66a	6/94	86 ^d	30	
4 ^c	SEt	Piperidine (cat.), toluene, reflux, 120h	66a	6/94	87 ^f	29	
5 ^b	OEt	pressure tube, 125 °C, 2h	66b	15/85	86 ^d	29	
6 ^c	OEt	11 kbar, 20 °C, 24h	66b	64/36	90 ^d	29	

^aA large excess of dienophile was used: 10 equiv. ^bTwo steps sequence. ^cOne-pot reaction. ^dYield after HDA reaction. ^eOverall yield after Knoevenagel and HDA reactions. ^fYield after domino Knoevenagel-HDA sequence.

3.1.2. [3+2] Cycloadditions

Phosphonylated thiocarbonyl ylides **70** and **74** belong to the class of so called ‘S-centered’ 1,3-dipoles, which can be generated *in situ* by two main methods: i) by reacting phosphonodithioformate **68** with diazomethane **67a**,^{31–33} or its silylated derivative **67b**³⁴ (Method 1, Scheme 24); ii) by reacting diazomethylphosphonate **71** with thioketones **72** (Method 2, Scheme 24).^{35,36}

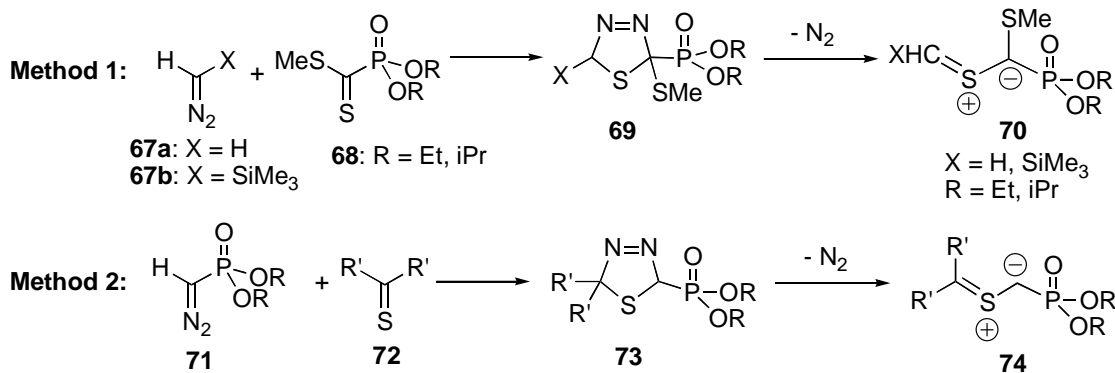
**Scheme 24**

These phosphonylated thiocarbonyl ylides undergo typical [3+2] cycloadditions with electron-deficient dipolarophiles yielding phosphonylated sulfur heterocycles. Although these heterocycles can contain more than one sulfur atom and other heteroatoms (depending on the dipolarophile structure), according to the scope of this review, only reactions leading to sulfur heterocycles containing one sulfur atom are discussed (reactions with C=C dipolarophiles). Thiocarbonyl ylides **70** react with dipolarophiles such as maleic anhydride (Y=O) and *N*-cyclohexylmaleimide (Y=N-*c*-C₆H₁₁), leading to phosphonylated bicyclic products of type **75** (Scheme 25).^{33,34}

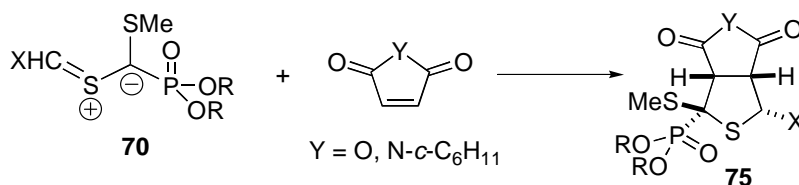
**Scheme 25**

The reaction of phosphonylated thiocarbonyl ylide **76** derived from 9*H*-fluorene-9-thione with diethyl diazomethylphosphonate were tested with several *C,C*-dipolarophiles. Only tetracyanoethylene (TCNE) afforded the corresponding 2-phosphonylated tetracyanothiolane **77** (Scheme 26).³⁵

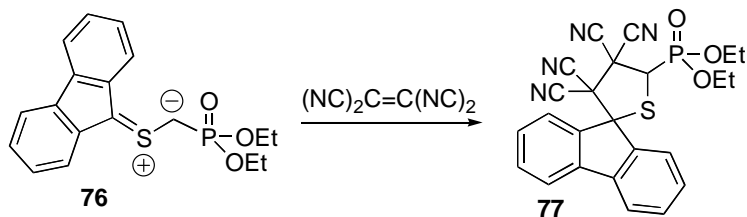

Scheme 26

3.2. Syntheses based on intramolecular cyclizations

3.2.1. Carbanion mediated cyclizations

Deprotonation of sulfanyl diphenylphosphine oxide **78** at α -position by potassium carbonate at room temperature, followed by intramolecular alkylation with allyl iodide, led to 8-membered sulfur heterocycle **79** (Scheme 27).³⁷ The major product (83%) displays *cis*-geometry; only a small amount of the *trans* isomer was detected. This type of α -phosphinoyl heterocyclic sulfides has been used as precursors for the synthesis of mercaptomacrolactones analogues of phoracantholide, which is a component of the highly odoriferous defense secretion of the eucalypt longicorn, *Phoracantha synonyma*.

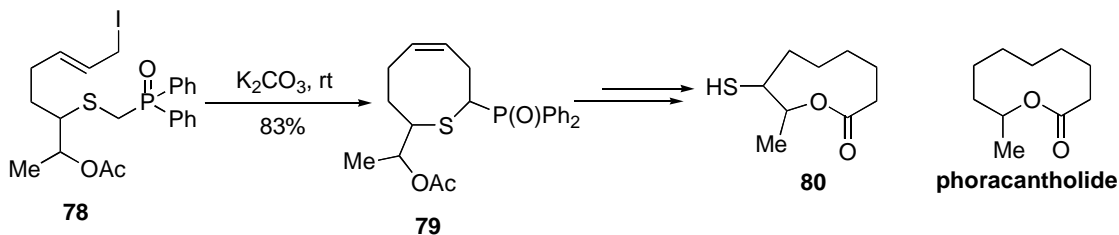

Scheme 27

3.2.2. Carbenoid mediated cyclizations

Diazophosphonylated mercaptan **81** reacts in the presence of rhodium(II) acetate to give cyclic phosphonylated thiolan-3-one **82** in modest yield (44%) (Scheme 28).³⁸ The reaction involves an intramolecular insertion of the carbenoid species into the S–H bond.

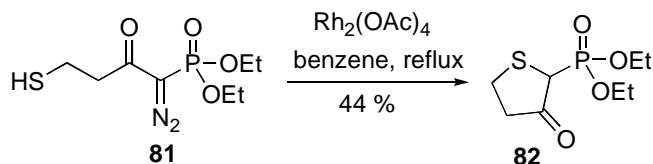

Scheme 28

3.2.3. Radical mediated cyclizations

Radical intramolecular 5-*endo*-cyclization of α -mercaptophosphonate **83**³⁹ led to the corresponding phosphorylated thiolane **84** without epimerization (Scheme 29). The oxidation of 2-phosphonothiolane into

the corresponding sulfoxide **85** was totally stereoselective with a complete transfer of the asymmetry from the carbon to the sulfur atom. The relative *trans* configuration of the C–P and S–O bonds has been demonstrated.

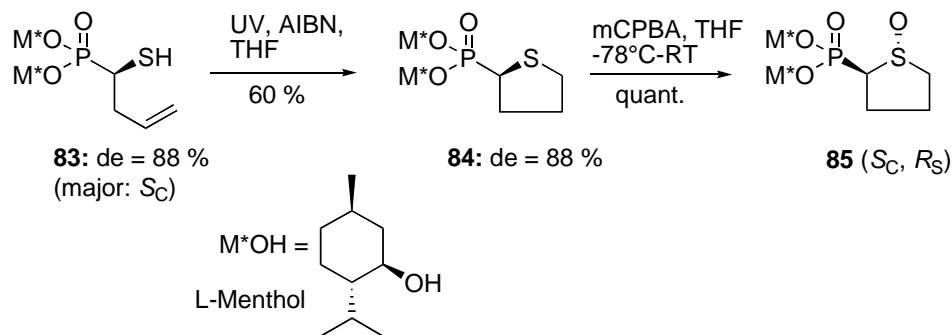

1-Iodo-2-allylsulfanyl phosphonate **86** was submitted to radical reaction conditions ($\text{Bu}_3\text{SnH/AIBN}$) in order to study *5-exo* versus *6-endo* cyclization process.⁴⁰ The major product was identified as the 2,3-dihydrothiophene derivative **87** resulting from *5-exo* cyclization, together with a trace amount of the 6-membered ring product **88** (Scheme 30).

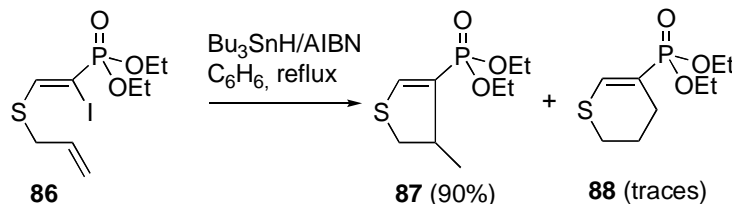

3.2.4. Electrocyclizations

3.2.4.1. 1,3-Dipolar electrocyclizations

Phosphonylated thiocarbonyl ylides (see Chapter 3.1.2.) undergo electrocyclic ring closure to give the corresponding thiiranes. Thiocarbonyl ylides **89a** and **89b**, derived from aromatic thioketones, afforded unstable thiiranes **90**, which spontaneously eliminated the sulfur atom to yield the corresponding vinylphosphonates **91** (Scheme 31).³⁵

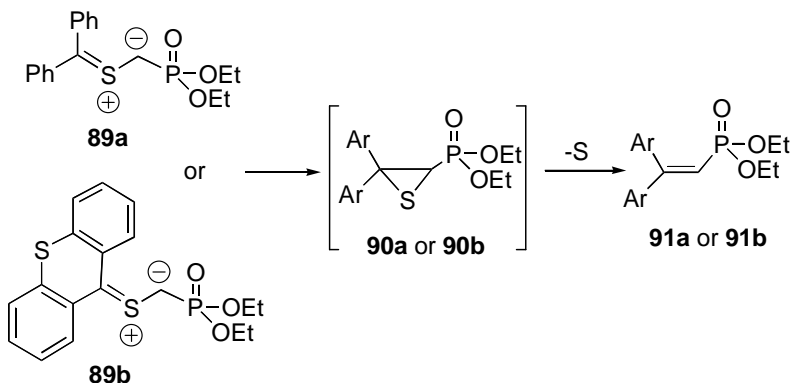

The reaction of the diisopropyl phosphonyldithioformate **68b** with dimethoxycarbene $[:C(OMe)_2]$ afforded also the corresponding vinylphosphonate, which is believed to be the product of spontaneous desulfurization of the intermediate thiirane under the reaction conditions (toluene, reflux).^{36a}

In comparison with their aromatic counterparts, phosphonylated thiocarbonyl ylides **92** derived from cycloaliphatic thioketones, after 1,3-dipolar electrocyclicization, gave stable thiiranyl phosphonates **93** (Scheme 32).^{36b} The latter can be desulfurized smoothly by treatment with tris(diethylamino)phosphine to give the corresponding vinylphosphonates.

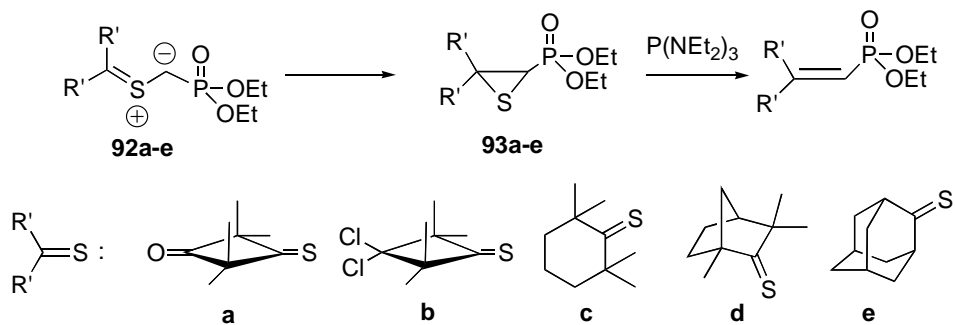

3.2.4.2. Domino Knoevenagel/1,6-heteroelectrocyclizations

Reacting phosphonodithioacetate **64** and α,β -unsaturated aldehydes such as cinnamaldehyde and crotonaldehyde **94a** and **94b**, under Knoevenagel conditions, directly led to 5-phosphono substituted 2*H*-thiopyrans **96a** and **96b**, respectively, *via* the electrocyclicization of 1-thia heterotriene intermediate **95** (Scheme 33).⁴¹ Reaction between dithioester **64** and electron-deficient indolic aldehydes **94c–d** (bearing an electron-withdrawing group on the nitrogen atom, *N*-tosyl or *N*-triflyl group) afforded dienes **95c** and **95d** respectively, which underwent consecutive heteroelectrocyclisation to afford thiopyrans **97c** and **97d** (in mixture with starting **95c,d**). The ratio of the product **97d** in the (**95**+**97**) mixture was slightly higher than that of **97c** (87/13 *vs.* 76/24). In both cases, attempts to separate the phosphorylated thiopyran **97** from its open chain precursor **95** by chromatography on silica gel led to the degradation of the products.

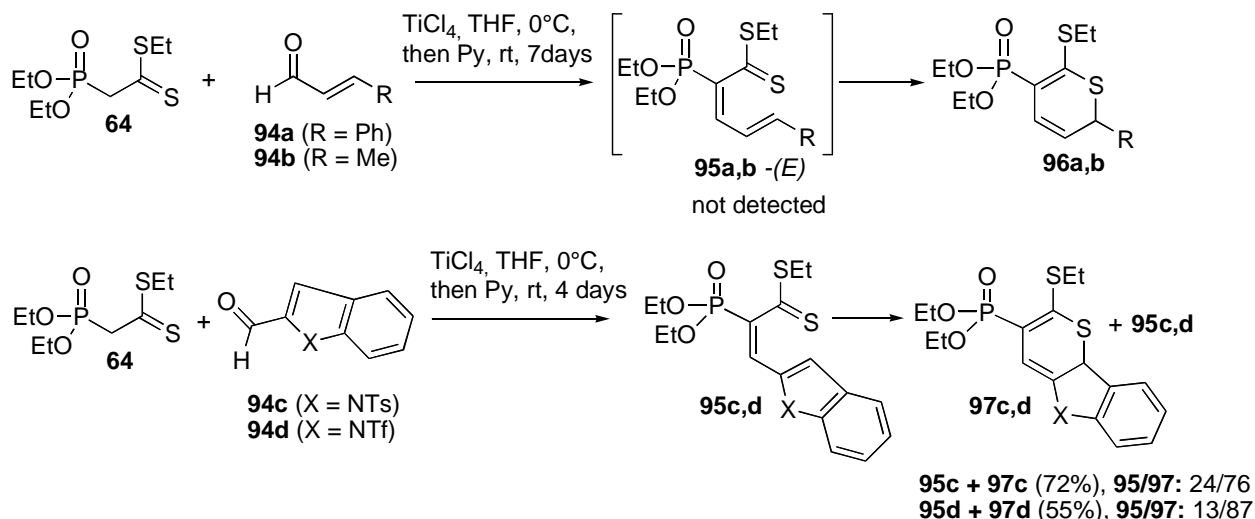

3.3. Miscellaneous

3.3.1. Sigmatropic rearrangements

3.3.1.1. [2,3]-Sigmatropic rearrangement

The [2,3]-sigmatropic rearrangement in the sulfur series (also called thia-Wittig rearrangement) has been studied with α -allylsulfanyl substituted carbanion or ylide stabilized by a phosphonyl group.^{39,42-46} Sulfonium ylides were directly generated from diisopropyl diazomethylphosphonate **71** and allylic sulfides, under Cu(II) or Rh(II) catalysis.²⁹ Among allylic sulfides, a sulfur heterocyclic substrate was used, the 2-vinyl thiolane **98**. Its reaction with diazoester **71** in the presence of copper acetyl acetonate as catalyst led, *via* sulfur ylide **99**, to the 2-thiocyclooctenyl phosphonate **100** in 51% yield (Scheme 34).

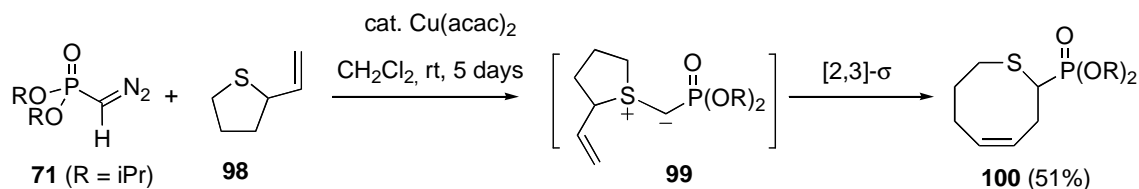

Scheme 34

The reaction of sulfanyl diphenylphosphine oxide **101** with potassium carbonate at 80 °C in refluxing acetonitrile (for reaction at room temperature see § 3.2.1), yielded the 9-membered sulfur heterocycle **103** *via* a [2,3]-sigmatropic shift involving ylide **102** (Scheme 35).³⁷ The major product obtained in this case had the *trans*-geometry.

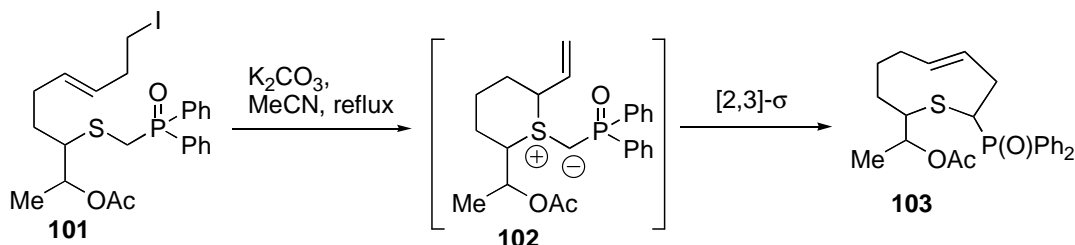

Scheme 35

3.3.1.2. [1,3]-Sigmatropic rearrangement

The sulfur to carbon 1,3-migration of the phosphoryl group (also called arylthiophosphate *o*-mercaptoarylphosphonate rearrangement) associated with the *ortho*-lithiation of dialkyl aryl thiophosphates by LDA has been described by Masson and collaborators.⁴⁷ The presence of bulky isopropyl groups on the phosphoryl moiety is required, as with ethyl groups the reaction failed due to the predominant attack of the P=O group by the base and cleavage of the P–S bond leading to thiophenol. The reaction has also been extended to heteroaromatic thiophosphate substrates.⁴⁸ In this series, 2- and 3-thienyl thiophosphates derivatives **104** rearranged into 2-thiolato-3-thienyl and 3-thiolato-2-thienyl phosphonates **105** (Scheme 36). The low yields (21% and 47%) are partly due to the instability of the resulting mercaptothiophenes **106a,b**.⁴⁷ Yields can be improved however if the intermediate thiolates are trapped by S-alkylation. For example the methylsulfanyl derivatives **106a'** and **106b'** have been obtained in 36% and 63% yield, respectively.⁴⁸

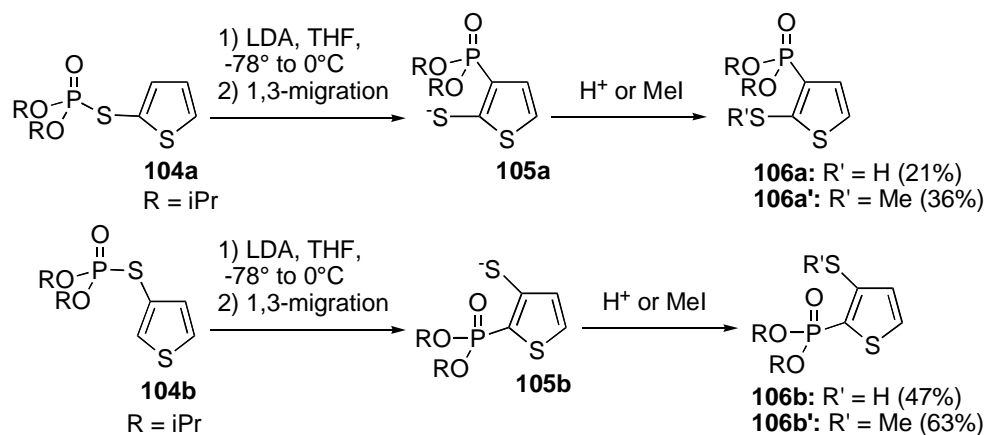

Scheme 36

3.3.2. Ring-closing metathesis

α -(Allyl-allylsulfanyl)phosphonates **107** react under ring-closing metathesis conditions to give 3,6-dihydro-2*H*-pyran phosphonates **108** (Scheme 37).⁴⁹ A low yield (19 %) was obtained when R¹=H, but with a carboxylate substituent the reaction afforded good yields.

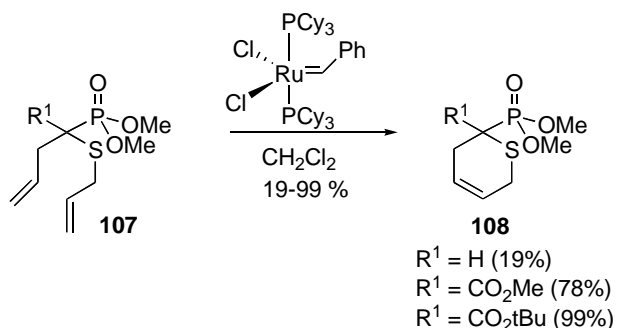

Scheme 37

Thioarylketene *S,N*-acetal **109** was treated with diethyl (2-oxopropyl)phosphonate **110** in the presence of mercury(II) acetate in dichloromethane, at room temperature to give 3-methylamino-5-phenylthiophene phosphonate **111** (Scheme 38).⁵⁰

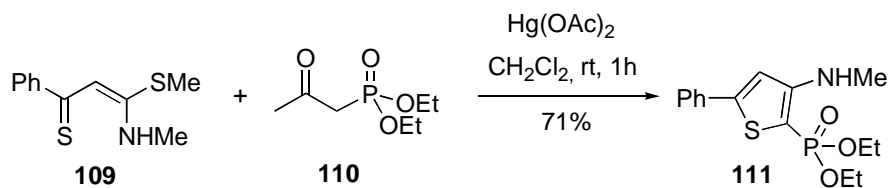

Scheme 38

Addition of sodium hydrosulfide to bis(diethoxyphosphoryl)acetylene **112** followed by an intramolecular cyclization led to 2,3-dihydrothiophene **113** carrying four phosphoryl groups (Scheme 39).⁵¹ When sodium sulfide was used instead of sodium hydrosulfide, the tetraphosphoryl derivative was obtained only in trace amount and the isolated product was the triphosphorylthiophene **114**. The two phosphoryl groups at the 2 and 3 positions of the heterocycle are *trans*, reflecting the most thermodynamically stable form.

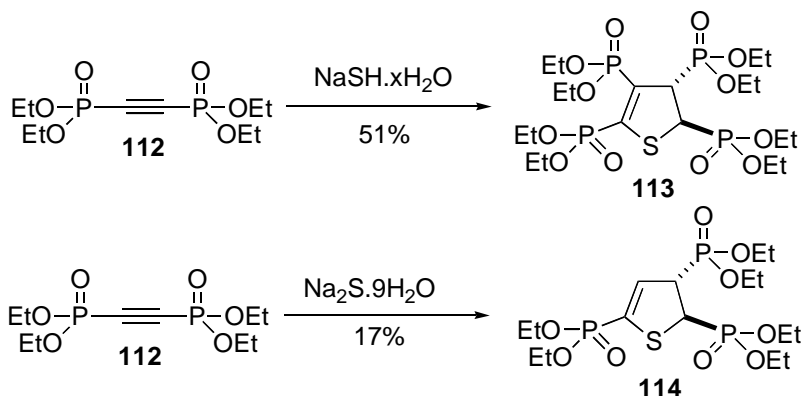

Reaction between β -ketophosphonates **115**, activated methylene nitrile derivatives **116** and sulfur under basic conditions led to 2-amino-5-phosphono thiophenes **117** (Scheme 40).⁵² These products are obtained regioselectively only when R=H, otherwise (with R=Me) the 2-amino-4-(phosphonomethyl)-thiophene regioisomers are obtained.

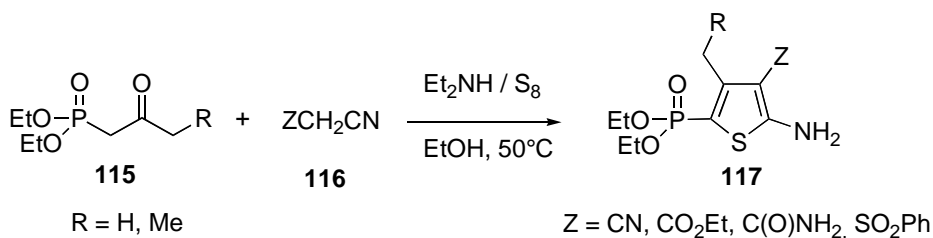

1,2-Epoxy-1-alkyl phosphonates or phosphinates **118** can be transformed into the corresponding thiiranes **119** by treatment with thiourea, in methanol, at room temperature (Scheme 41).⁵³ Upon heating to reflux in methanol, desulfurization occurred leading to vinyl phosphonates or phosphinates **120**.

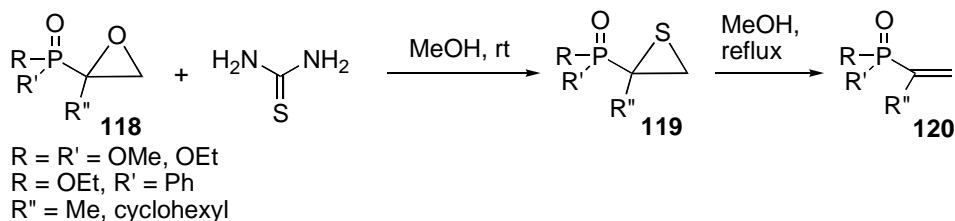

4. Conclusion

As shown in this review, interest in the synthesis of phosphorus-substituted sulfur heterocycles has grown up in the last years. This can be explained by their wide applications in various fields such as biomolecular chemistry (analogues of biomolecules), catalysis (ligands), materials (hydrid organic–inorganic materials), which mainly arises from the difunctionality, the geometry of the sulfur heterocycle and the relative position of the two functions, as both phosphorus and sulfur functions can be involved

independently or together in the reactivity of the compound (bidentate chelation of a metal, activation of a function by the other one...). The numerous existing procedures to synthesize such compounds enable now to access a reasonable variety of structures, which is important for the tailoring of the biological and catalytic properties. It is worth noting that structure/relationship properties in the biological field as well as in the catalytic field still have to be established for many of these derivatives in order to fully exploit their original properties.

Acknowledgments

The work done in the group has been performed within the institute of chemistry (INC3M FR 3038). The authors thank for financial support the “Ministère de la Recherche et des Nouvelles Technologies”, the CNRS, the “Région Basse-Normandie” and the European Union (FEDER funding).

References

1. Mikolajczyk, M.; Balczewski, P. *Advances in Sulfur Chemistry* **1994**, *1*, 41–96.
2. Gulea, M.; Masson, S. *Recent Advances in the Chemistry of Difunctionalized Organo-Phosphorus and -Sulfur Compounds In Top. Curr. Chem., New Aspects in Phosphorus Chemistry III*; Majoral, J.-P., Ed.; 1991; Vol. 229, pp. 161–198.
3. Kruse, C. G.; Poels, E. K.; van der Gen, A. *J. Org. Chem.* **1979**, *44*, 2911–2915.
4. Gerbier, P.; Guérin, C.; Henner, B.; Unal, J.-R. *J. Mater. Chem.* **1999**, *9*, 2559–2565.
5. Locklin, J.; Patton, D.; Deng, S.; Baba, A.; Advincula, R. C. *Chem. Mater.* **2004**, *16*, 5187–5193.
6. Benincori, T.; Pilati, T.; Rizzo, S.; Sannicolò, F.; Burk, M. J.; de Ferra, L.; Ullucci, E.; Piccolo, O. *J. Org. Chem.* **2005**, *70*, 5436–5441.
7. Tietze, L. F.; Lohmann, J. K.; Stadler, C. *Synlett* **2004**, 1113–1116.
8. Rabasso, N.; Louaisil, N.; Fadel, A. *Tetrahedron* **2006**, *62* 7445–7454.
9. Mori, I.; Kimura, Y.; Nakano, T.; Matsunaga, S.-I.; Iwasaki, G.; Ogawa, A.; Hayakawa, K. *Tetrahedron Lett.* **1997**, *38*, 3543–3546.
10. Lee, S. S.; Lee, T.-Y.; Choi, D. S.; Lee, J. S.; Chung, Y. K.; Lee, S. W.; Lah, M. S. *Organometallics* **1997**, *16*, 1749–1756.
11. Garossian, M. *Phosphorus, Sulfur and Silicon* **1994**, *88*, 279–282.
12. Marchand, P.; Gulea, M.; Masson, S.; Averbuch-Pouchot, M.-T. *Synthesis* **2001**, 1623–1626.
13. Kielbasinski, P.; Lyzwa, P.; Mikolajczyk, M.; Gulea, M.; Lemarié, M.; Masson, S. *Tetrahedron: Asymmetry* **2005**, *16*, 651–655.
14. Łyżwa, P.; Jankowiak, A.; Kwiatkowska, M.; Mikołajczyk, M.; Kiełbasiński, P.; Betz, A.; Jaffres, P.-A.; Gaumont, A.-C.; Gulea, M. *Tetrahedron Lett.* **2007**, *48*, 351–355.
15. Vedejs, E.; Mastalerz, H.; Meier, G. P.; Powell, D. W. *J. Org. Chem.* **1981**, *46*, 5253–5254.
16. Ordóñez, M.; Juaristi, E. *Tetrahedron* **1998**, *54*, 1375–1380.
17. Artemova, N. V.; Chevykalova, M. N.; Luzikov, Y. N.; Nifant'ev, I. E.; Nifant'ev, E. E. *Tetrahedron* **2004**, *60*, 10365–10370.
18. (a) Benincori, T.; Brenna, E.; Sannicolò, F.; Trimarco, L.; Antognazza, P.; Cesarotti, E.; Demartin, F.; Pilati, T. *J. Org. Chem.* **1996**, *61*, 6244–6251. (b) Sannicolò, F.; Benincori, T.; Rizzo, S.; Gladiali, S.; Pulacchini, S.; Zotti, G. *Synthesis* **2001**, 2327–2336.
19. Benincori, T.; Cesarotti, E.; Piccolo, O.; Sannicolò, F. *J. Org. Chem.* **2000**, *65*, 2043–2047.
20. Berens, U.; Englert, U.; Geysler, S.; Runsink, J.; Salzer, A. *Eur. J. Org. Chem.* **2006**, 2100–2109.
21. Vedejs, E.; Eberlein, T. H.; Mazur, D. J.; McClure, C. K.; Perry, D. A.; Ruggeri, R.; Schwartz, E.; Stults, J. S.; Varie, D. L.; Wilde, R. G.; Wittenberger, S. *J. Org. Chem.* **1986**, *51*, 1556–1562.
22. (a) Metzner, P. *Synthesis* **1992**, 1185–1199. (b) Metzner, P.; Thuillier, A. In: *Sulfur Reagents in Organic Synthesis*; Academic Press: London, 1994. (c) Metzner, P. In *Top. Curr. Chem.; Organosulfur Chemistry I*; Springer-Verlag: Berlin, 1999; Vol. 204, p. 127–181.
23. Heuzé, B.; Gasparova, R.; Heras, M.; Masson, S. *Tetrahedron Lett.* **2000**, *41*, 7327–7331.
24. Heras, M.; Gulea, M.; Masson, S. *Chem. Commun.* **2001**, 611–612.

25. Heras, M.; Gulea, M.; Masson, S.; Philouze, C. *Eur. J. Org. Chem.* **2004**, 160–172.
26. Denancé, M.; Legay, R.; Gaumont, A.-C.; Gulea, M. *Tetrahedron Lett.* **2008**, *49*, 4329–4332.
27. Porskamp, P. A. T. W.; Lammerink, B. H. M.; Zwanenburg, B. *J. Org. Chem.* **1984**, *49*, 263–268.
28. Lucassen, A. C. B.; Zwanenburg, B. *Eur. J. Org. Chem.* **2004**, 74–83.
29. Al-Badri, H.; Collignon, N.; Maddaluno, J.; Masson, S. *Tetrahedron* **2000**, *56*, 3909–3919.
30. Al-Badri, H.; Collignon, N.; Maddaluno, J.; Masson, S. *Chem. Commun.* **2000**, 1191–1192.
31. Urbaniak, K.; Mloston, G.; Gulea, M.; Masson, S.; Linden, A.; Heimgartner, H. *Eur. J. Org. Chem.* **2005**, 1604–1612.
32. Urbaniak, K.; Mloston, G.; Gulea, M.; Masson, M.; Heimgartner, H. *Polish J. Chem.* **2005**, *79*, 1483–1494.
33. Mloston, G.; Urbaniak, K.; Gulea, M.; Masson, S.; Linden, A.; Heimgartner, H. *Helv. Chim. Acta* **2005**, *88*, 2582–2592.
34. Mloston, G.; Urbaniak, K.; Linden, A.; Heimgartner, H. *Heterocycles* **2007**, *73*, 419–432.
35. Lesniak, S.; Mloston, G.; Urbaniak, K.; Wasiaak, P.; Linden, A.; Heimgartner, H. *Tetrahedron* **2006**, *62*, 7776–7782.
36. (a) Dawid, M.; Mloston, G.; Reid, D. L.; Warkentin, J. *Can. J. Chem.* **2003**, *81*, 1025–1028. (b) Mloston, G.; Urbaniak, K.; Lesniak, S.; Wasiaak, P.; Heimgartner, H. *Heterocycles* **2007**, *72*, 541–552.
37. Vedejs, E.; Powel, D. W. *J. Am. Chem. Soc.* **1982**, *104*, 2046–2048.
38. Moody, C. J.; Taylor, R. J. *Tetrahedron* **1990**, *46*, 6501–6524.
39. Marchand, P.; Gulea, M.; Masson, S.; Saquet, M.; Collignon, N. *Org. Lett.* **2000**, *2*, 3757–3759.
40. Ageno, T.; Okauchi, T.; Minami, T.; Ishida, M. *Org. Biomol. Chem.* **2005**, *3*, 924–931.
41. Riu, A.; Harrison-Marchand, A.; Maddaluno, J.; Gulea, M.; Albadri, H.; Masson, S. *Eur. J. Org. Chem.* **2007**, 4948–4952.
42. Makomo, H.; Saquet, M.; Simeon, F.; Masson, S.; About-Jaudet, E.; Collignon, N.; Gulea-Purcarescu, M. *Phosphorus, Sulfur and Silicon* **1996**, *109–110*, 445–448.
43. Makomo, H.; Masson, S.; Putman, D.; Saquet, M.; Simeon, F.; About-Jaudet, E.; Collignon, N. *Phosphorus, Sulfur and Silicon* **1996**, *112*, 193–202.
44. Gulea, M.; Marchand, P.; Saquet, M.; Masson, S.; Collignon, N. *Phosphorus, Sulfur and Silicon* **1999**, *153–154*, 327–328.
45. Gulea, M.; Marchand, P.; Masson, S.; Saquet, M.; Collignon, N. *Synthesis* **1998**, 1635–1638.
46. Lemée, L.; Gulea-Purcarescu, M.; Masson, S.; Saquet, M.; Collignon, N. *Heteroatom Chem.* **1999**, *10*, 281–289.
47. Masson, S.; Saint-Clair, J.-F.; Saquet, M. *Synthesis* **1993**, 485–486.
48. (a) Masson, S.; Saint-Clair, J.-F.; Saquet, M. *Tetrahedron Lett.* **1994**, *35*, 3083–3084. (b) Masson, S.; Saint-Clair, J.-F.; Dore, A.; Saquet, M. *Bull. Soc. Chim. Fr.* **1996**, *133*, 951–964.
49. Moore, J. D.; Sprott, K. T.; Hanson, P. R. *Synlett* **2001**, 605–608.
50. (a) Kim, B. S.; Kim, K. *J. Org. Chem.* **2000**, *65*, 3690–3699. (b) Kim, K.; Kim, B. S.; Choi, K. S. *Phosphorus, Sulfur and Silicon* **1999**, *153–154*, 393–394.
51. Sasaki, S.; Adachi, K.; Yoshifuji, M. *Org. Lett.* **2007**, *9*, 1729–1732.
52. Said, N.; Touil, S.; Zantour, H. *Phosphorus, Sulfur and Silicon* **2003**, *178*, 1891–1899.
53. Inokawa, S.; Yamamoto, H. *Phosphorus, Sulfur and Silicon* **1983**, *16*, 79–81.

CARBOLITHIATION REACTIONS IN THE SYNTHESIS OF HETEROCYCLES

Roberto Sanz* and Alberto Martínez

Departamento de Química, Área de Química Orgánica, Facultad de Ciencias, Universidad de Burgos, Pza. Misael Bañuelos s/n, E-09001 Burgos, Spain (e-mail: rsd@ubu.es)

Abstract. *The inter- or intramolecular addition of organolithiums to non-activated carbon–carbon double or triple bonds has now become an efficient way of constructing heterocyclic systems. The control of chemo-, regio-, and stereoselectivity achievable within this type of reactions allows the synthesis of a wide variety of heterocyclic derivatives from usually simple precursors. Although mainly confined to the formation of five-membered rings, intramolecular carbolithiations allow the regioselective functionalization of the resulting heterocyclic compound by trapping of the intermediate lithiated heterocycles with selected electrophiles. In this review, we present the most significant examples in this field.*

Contents

1. Introduction
 2. Intermolecular reactions
 - 2.1. General aspects of intermolecular carbolithiation reactions
 - 2.2. Synthesis of indole derivatives
 - 2.3. Synthesis of quinoline derivatives
 - 2.4. Synthesis of other heterocyclic systems
 3. Intramolecular reactions
 - 3.1. Special features of intramolecular carbolithiation reactions
 - 3.1.1. Stereoselectivity and mechanism
 - 3.1.2. Scope and limitations
 - 3.2. Synthesis of furan derivatives
 - 3.3. Synthesis of benzofuran derivatives
 - 3.4. Synthesis of pyrrole derivatives
 - 3.5. Synthesis of azabicyclo derivatives
 - 3.6. Synthesis of indole derivatives
 - 3.7. Synthesis of other heterocyclic systems
 - 3.8. Synthesis of heterocycles through carbolithiation of arynes
 4. Conclusions
- Acknowledgments
- References

1. Introduction

The addition of a carbon–lithium bond of an organolithium reagent **1** across an unactivated alkene or alkyne derivative **2**, leading to a new organolithium compound **3**, is termed a carbolithiation reaction (Scheme 1).¹ This type of processes can be considered as a subset of the family of carbometalation reactions.² Generally, we refer to carbolithiation reactions when the attacked carbon–carbon multiple bond is non-polarized or weakly polarized.

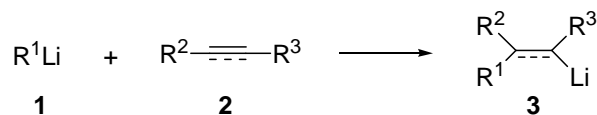

Scheme 1

They can be divided into inter- and intramolecular reactions. In the intermolecular case the carbometalation ability of **1** must be higher than that of **3** to prevent the formation of polymers, however, in the intramolecular version, where entropy factors are favorable, the starting organolithium and the product could have similar reactivities. In both cases, it should be possible to functionalize the resulting organolithium by its reaction with electrophiles, offering an efficient means of broadening the synthetic usefulness of these reactions. We have divided the topic according to the inter- or intramolecular nature of the carbolithiation reaction involved. Within each section, after an overview of general aspects of the referred reactions, we shall then consider the more significant advances in this field related to the synthesis of heterocyclic compounds.

2. Intermolecular reactions

2.1. General aspects of intermolecular carbolithiation reactions

Alkene carbolithiation could be considered a synthetically efficient procedure as the intermediate organolithium is generated with complete atom economy and can be trapped with a wide range of electrophiles. However, this process is not always viable in practice because if the produced organolithium **3** reacts with a second molecule of the alkene, an anionic polymerization process could be initiated.³ In order to accomplish an intermolecular carbolithiation reaction, conditions are required that will facilitate the initial carbolithiation but not favor further addition by the generated organolithium. The first successful example was reported by Bartlett and co-workers who described that secondary and tertiary alkyl lithium reagents were able to carbometalate ethene.⁴ Taylor and co-workers discovered that organolithium additions to styrene and styrene derivatives **4** are synthetically viable when Et₂O is employed as solvent providing a useful method for the preparation of a range of alkylated benzene derivatives **5** (Scheme 2).⁵ The reactivities of different types of organolithium reagents were found to be: tertiary, secondary > primary >> alkenyl, methyl, phenyl. With deactivated double bonds, the reactions with BuLi can be facilitated by using TMEDA as co-solvent. Other authors have also reported the carbolithiation reactions of α -alkyl⁶ and β -alkyl-substituted styrenes.⁷ The most important fact is that these processes are regioselective giving rise to the more stabilized benzyllithium derivative.

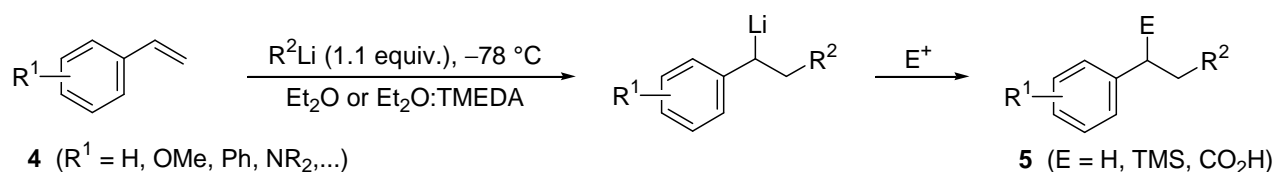

Scheme 2

On the other hand, the carbolithiation of β -alkyl-substituted styrenes such as (*E*)- β -methylstyrene **6** generates an organolithium intermediate with two contiguous stereocentres. Marek, Normant and co-workers have developed the enantioselective carbolithiation reaction of this substrate and of a wide variety of

cinnamyl derivatives **6** by using the lupine alkaloid (-)-sparteine instead of TMEDA (Scheme 3).⁸ From **6**, chiral benzene derivatives **7** were obtained with high *ee*, although the benzylic C–Li centre has low configurational stability. Interestingly, only a slightly lower *ee* (70%) is obtained for **7** (R=Bu) when the reaction is performed in the presence of a catalytic amount of (-)-sparteine (10 mol%). For cinnamyl derivatives **8** bearing heteroatoms able to coordinate the lithium atom, the addition is dependent on the stereochemistry of the initial double bond, and the resulting benzylic organolithium compound can be derivatized upon treatment with electrophiles to yield benzene derivatives **9** bearing a linear chain with good or excellent levels of diastereoselectivity. Representative examples are shown in Scheme 3, including the enantioselective synthesis of *trans*-disubstituted cyclopropanes **10** from acetal **8c** by a 1,3-elimination of the acetal group from the lithiated intermediate.⁸

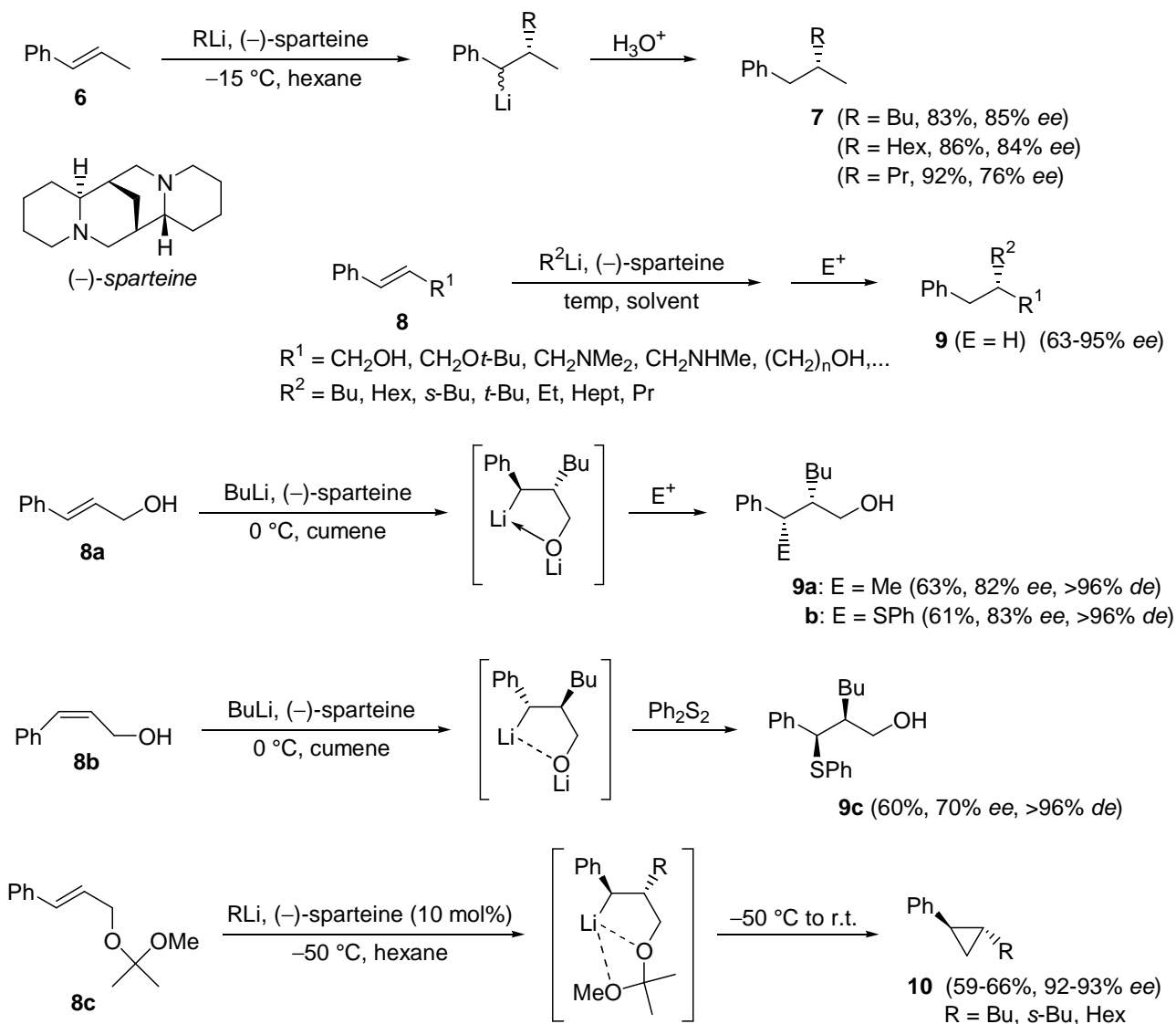

Scheme 3

2.2. Synthesis of indole derivatives

O'Shea and co-workers have exploited the synthetic utility of the intermolecular carbolithiation of styrene derivatives for the specific case of *o*-substituted styrenes **11**, due to the possibility of generating

benzo-fused ring systems **13** by trapping the intermediate benzylic lithiums **12** with suitable electrophiles and further *in situ* ring-closing reactions involving the *o*-substituent (Scheme 4).^{1g}

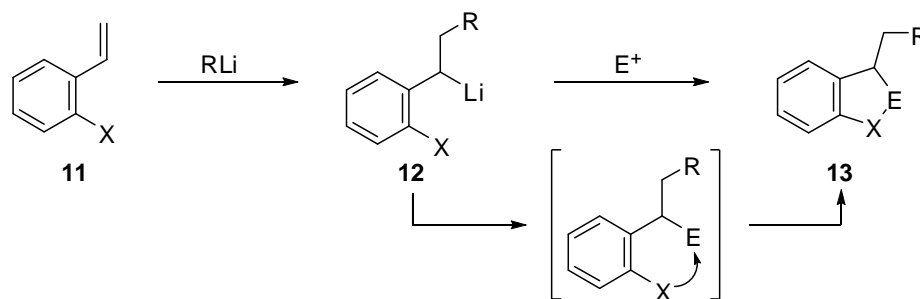

Scheme 4

Initially, these authors studied the intermolecular carbolithiation reaction of substituted *o*-amino-styrenes **14**, generated by a Pd-catalyzed cross-coupling reaction, to initiate a controlled cascade reaction sequence for the generation of indole derivatives (Scheme 5).⁹ This methodology involves alkyl lithium addition to the styrene double bond (for less reactive primary alkyl lithium the presence of TMEDA is required), and subsequent trapping of the intermediate organolithium **15** with a suitable electrophile, followed by *in situ* ring closure and dehydration. When DMF was used as electrophile, C-2 unsubstituted indole derivatives **16** were obtained, whereas the use of nitriles gave rise to indoles **17** that incorporate the nitrile substituent at C-2 (Scheme 5). Using milder acidification conditions, 2,3-dihydro-2-hydroxyindole derivative **18** and ketone **19** could be isolated indicating the presence of key intermediate dianions **15** and the reaction of the carbanion with the electrophile (Scheme 5). In this way, different functional groups can be introduced around the indole scaffold.⁹

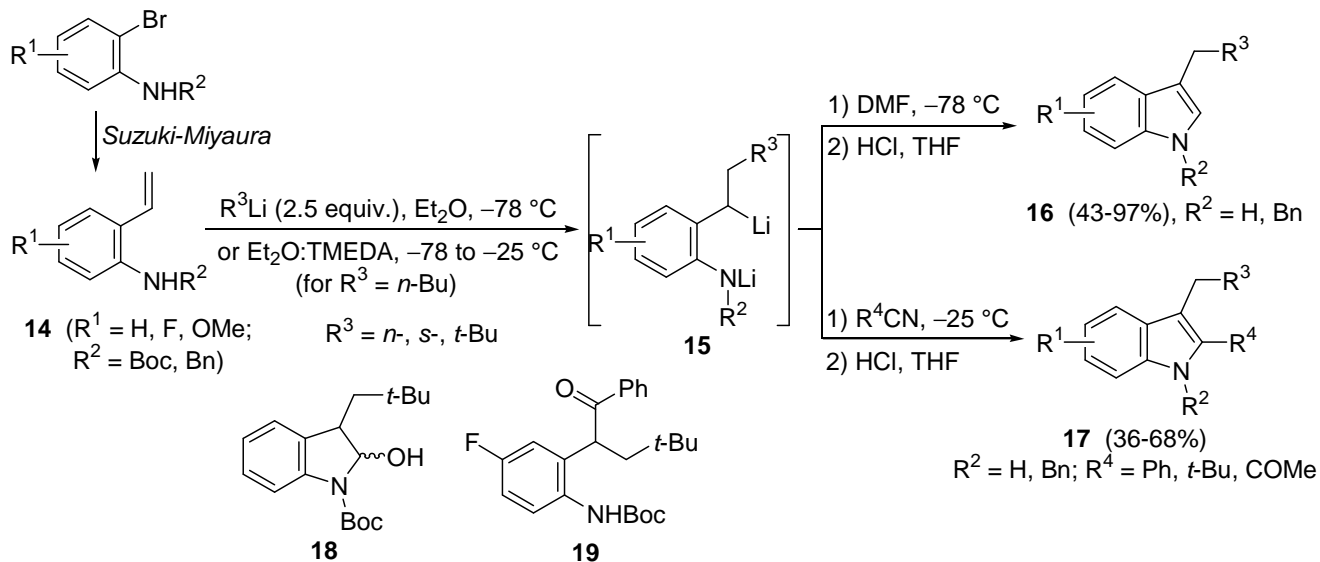

Scheme 5

The same authors also reported a similar methodology, *i.e.* combination of a vinylation procedure and a carbolithiation-electrophile trapping cyclization, for the synthesis of the functionalized 7-azaindole ring system. Despite the known propensity of the pyridine heterocycle to undergo addition reactions with

alkyllithiums, the carbolithiation is highly effective in THF at low temperature. 3-Vinyl-pyridine-2-amine derivatives **20** were prepared using the coupling of 2,4,6-trivinylcyclotriboroxane with 3-bromopyridine-2-amines as key step. And so, from pyridine derivatives **20**, 3,*n*-disubstituted 7-azaindoles **21** were obtained by reaction of the generated intermediate lithiated species with DMF. In addition, 2,3,*n*-trisubstituted 7-azaindoles **22** could be obtained when nitriles were used as electrophiles (Scheme 6).¹⁰ The reaction sequence allows for aryl, heteroaryl, alkyl and keto substituents to be included at different positions around the heterocycle.

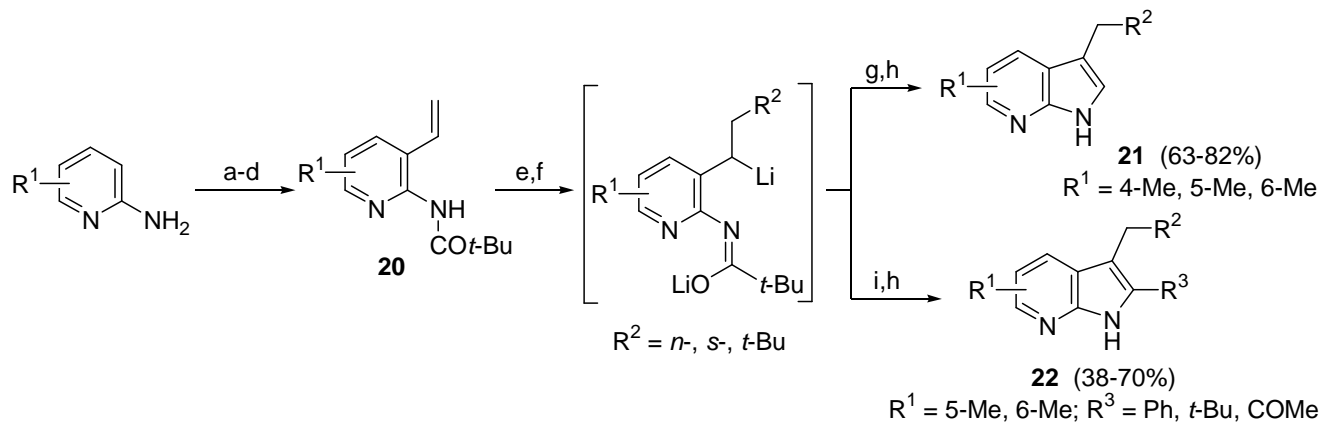

(a) *t*-BuCOCl, Et₃N, CH₂Cl₂, 0 °C; (b) BuLi, THF, -30 to 0 °C (c) Br(CH₂)₂Br, -78 °C to r.t., 25–81% for the three steps; (d) (CH₂=CHB-O)₃Py (0.5 equiv.), Pd(PPh₃)₄ (cat.), K₂CO₃ (1 equiv.), DME:H₂O, reflux, 60–86%; (e) PhLi (1.5 equiv.), THF, -30 °C; (f) R²Li (2 equiv.), -78 °C; (g) DMF, -78 °C; (h) HCl (aq), reflux; (i) R³CN, -78 to 0 °C.

Scheme 6

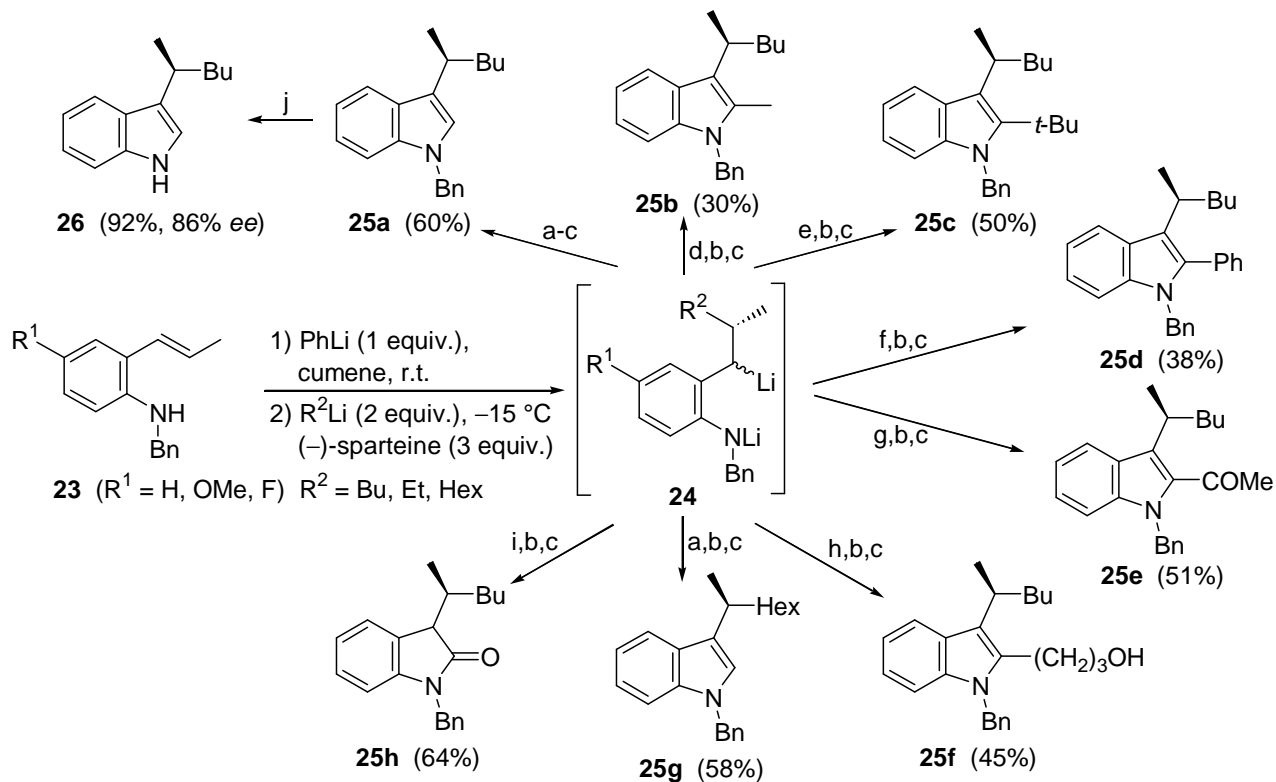

(a) DMF; (b), -15 °C to r.t.; (c) HCl (aq), r.t.; (d) MeCON(Me)OMe; (e) *t*-BuCN, THF; (f) PhCN, THF; (g) MeC(OEt)₂CN; (h) γ -butyrolactone; (i) CO₂; (j) Li, NH₃ (liq.), -78 °C.

Scheme 7

By exploiting an asymmetric carbolithiation of (*E*)-2-propenylarylamines **23**, chiral lithiated intermediates **24** can be readily generated under the influence of (–)-sparteine. The high synthetic potential of **24** was demonstrated by their reactions with selected electrophiles, followed by an *in situ* ring closure and dehydration. In this way, a variety of chiral substituted indoles and indolones **25a–h** has been synthesized with high enantioselectivity (82–86% *ee*) (Scheme 7).¹¹ The stereogenic centre, formed in high enantiomeric ratio in the first carbolithiation step, is carried through the cascade reaction sequence to the final products and is independent of electrophile used. When other alternative chiral ligands, like lithium alkoxides, lithium amides or bisoxazoline derivatives were tested, none of them afforded better results than (–)-sparteine. This fact highlights the exceptional complementary relationship of carbolithiation reactions with (–)-sparteine. Although the *N*-benzyl group is a requirement for high enantioselectivity, debenzilation of the final *N*-benzylindoles **25** can be achieved by treatment with lithium and ammonia without alteration of the optical purity, as it has been shown in the synthesis of *N*-unsubstituted indole **26** (Scheme 7).¹¹

2.3. Synthesis of quinoline derivatives

As expected, carbolithiation of styrenes and β -alkylstyrenes with alkyllithium reagents (see Schemes 5–7) was regioselective with the more stabilized benzylic lithiated regioisomers exclusively generated. With unsymmetrical stilbenes such as **27** two different benzylic lithiated regioisomers could be formed. O’Shea and co-workers have also shown that the carbolithiation of *o*-amino-(*E*)-stilbenes **27** is regioselective, when the reaction is performed in THF, to provide lithiated intermediates **28**.

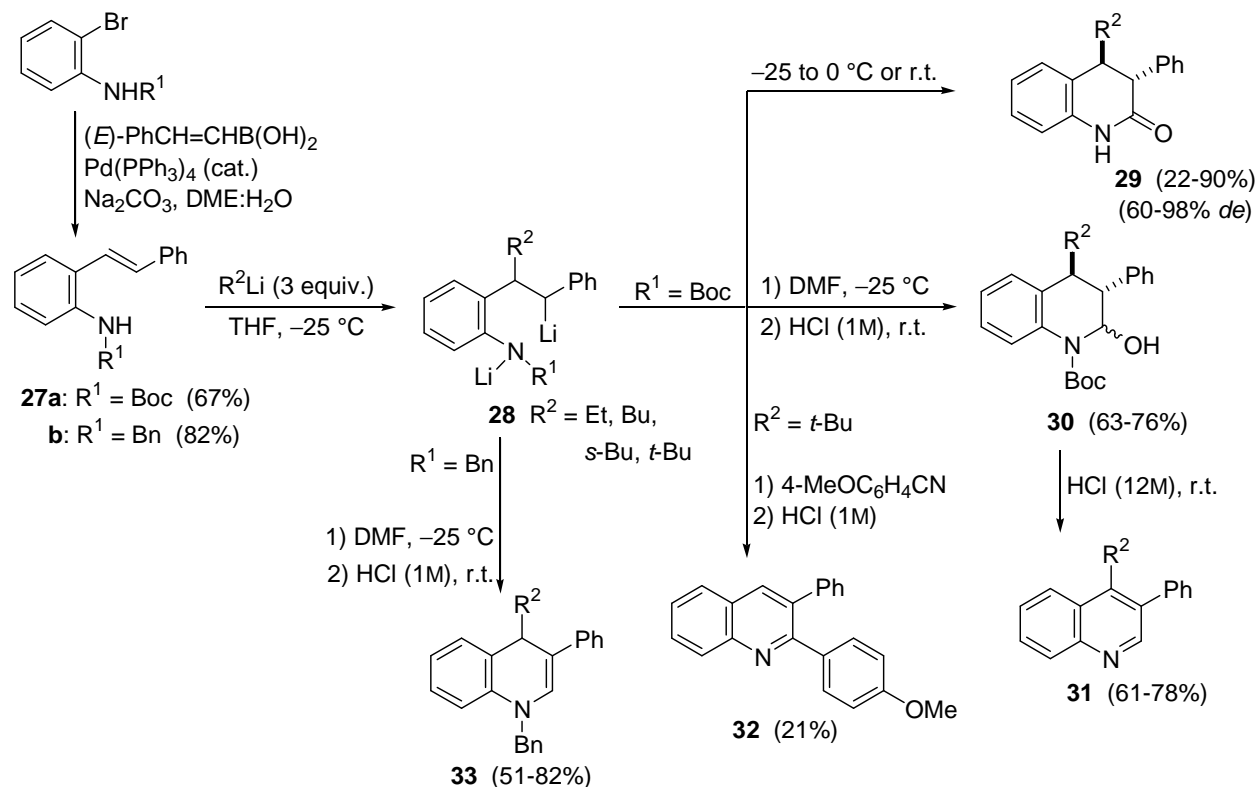

Scheme 8

A subsequent electrophilic trapping showed high levels of diastereoselectivity although it was influenced by both the *o*-amino substituent and the alkyllithium. In the case of **27a** and without the addition

of any electrophile, intramolecular attack of the benzylic lithium to the Boc group was achieved by raising the temperature affording 3,4-dihydro-1*H*-quinolin-2-ones **29** (Scheme 8).¹² These compounds were isolated as mixtures of 3,4-*trans*- and 3,4-*cis*-isomers, which upon purification were isomerized to the more stable *trans*-isomer. The treatment of **28** with DMF, followed by acidification, gave rise to 1,2,3,4-tetrasubstituted tetrahydroquinolines **30**, as mixtures of 2,3-*cis*-3,4-*trans*- and 2,3-*trans*-3,4-*trans*-isomers, which could be dehydrated and *in situ* oxidized to yield 3,4-disubstituted quinolines **31**. Surprisingly, in the case of using *t*-BuLi as alkyl lithium, the corresponding *t*-Bu-substituted tetrahydroquinoline loses the *t*-Bu group upon aromatization. And so, the 2,3-disubstituted quinoline **32** could be synthesized by using *t*-BuLi in the initial carbolithiation process and 4-methoxybenzotrile as electrophile (Scheme 8).¹² This methodology has also been extended to the synthesis of 1,4-dihydroquinoline derivatives **33** starting from *o*-*N*-benzylamino-(*E*)-stilbenes **27b** (Scheme 8).¹²

Interestingly, stilbene stereochemistry can modulate its reactivity with alkylolithiums from carbolithiation (see above) for *trans*-**27a** to vinyl deprotonation for *cis*-**27a**. Direct vinyl lithiation of *cis*-**27a** with *t*-BuLi/PMDTA provides a new route for the synthesis of 3-substituted indoles.¹³

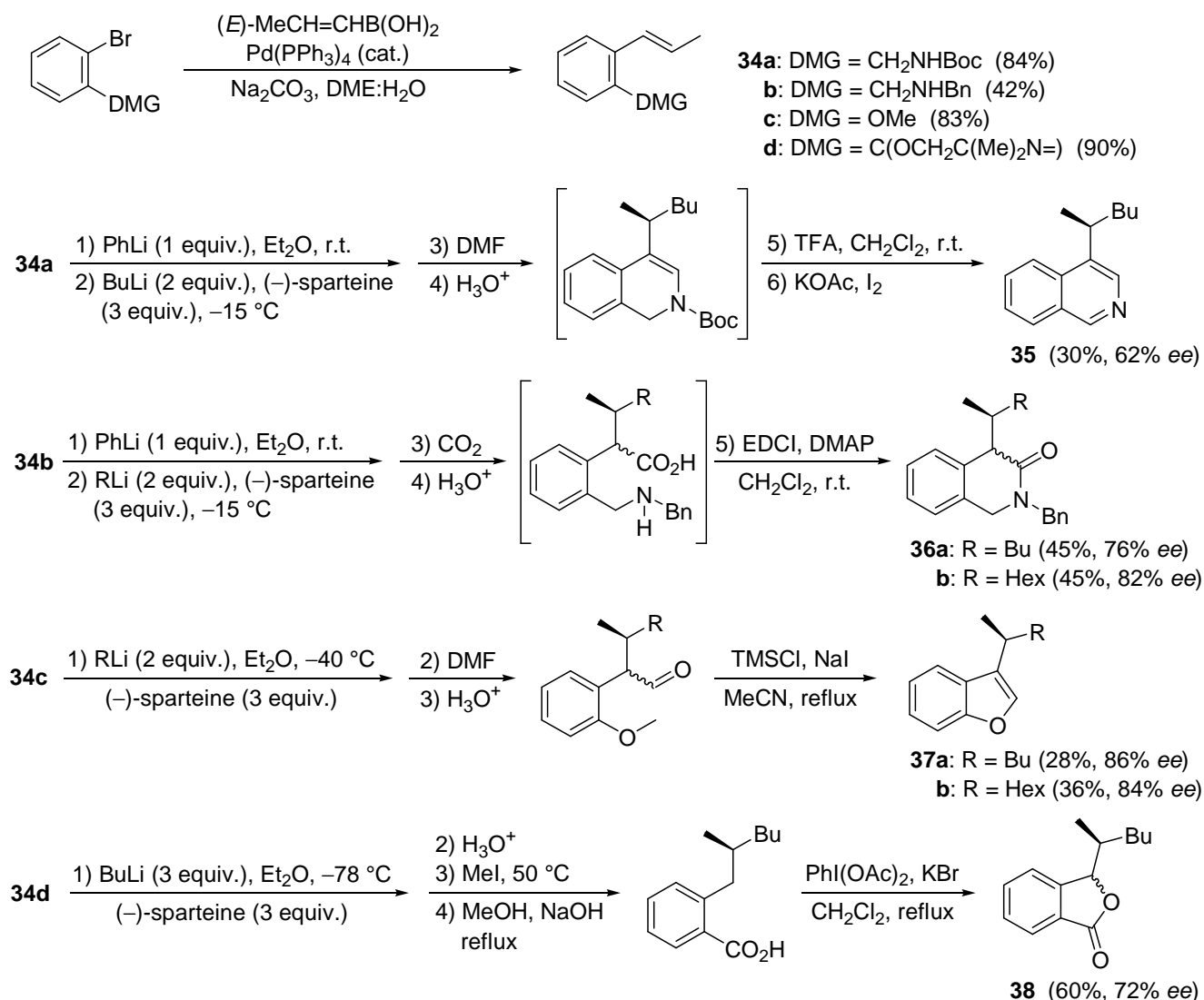

Scheme 9

2.4. Synthesis of other heterocyclic systems

O'Shea and co-workers have also extended the enantioselective carbolithiation of *o*-substituted β -methylstyrenes, initially applied for the synthesis of indole derivatives (see Scheme 7), to the preparation of other chiral heterocycles. For example, *o*-aminomethyl carbolithiated intermediate derived from **34a** afforded isoquinoline **35** upon treatment with DMF, acidification and further Boc-deprotection and oxidation with KOAc/I₂ (Scheme 9).¹⁴ In the same way, treatment of *N*-benzyl lithiated intermediate from **34b** with CO₂ introduced a carboxylic acid functional group, which following intramolecular amide coupling with 1-ethyl-3-(3'-dimethylaminopropyl)carbodiimide (EDCI) generated isoquinolinones **36** as mixtures of diastereoisomers (Scheme 9).¹⁴ On the other hand, formylation of the *o*-methoxy benzyllithium intermediate from **34c**, followed by *O*-demethylation, cyclization and dehydration gave rise to benzofuran derivatives **37** (Scheme 9).¹⁴ Finally, protonation and deprotection of the *o*-oxazoline benzyllithium derivative from **34d** afforded a chiral benzoic acid, which underwent lactone formation upon treatment with PhI(OAc)₂/KBr yielding isobenzofuranone **38** (Scheme 9).¹⁴ As shown, the best enantioselectivities for the initial carbolithiation step were obtained for anisole derivative **34c** and were similar than those obtained for the carbolithiation of *o*-aniline derivative **23** (see Scheme 7).

Tomooka and Igawa have described a remarkable acceleration effect of phenyl-substituted silyl groups in hydroalumination and carbolithiation reactions of propargylic alcohols, attributed to an increase of electrophilicity of the β -carbon atom on the alkynyl group caused by the phenyl groups on the silicon atom. So, a regioselective carbolithiation of unsymmetrical dialkyne **39** took place in the presence of TMEDA affording stereoselectively a vinylolithium species that was trapped with CO₂. Subsequent intramolecular cyclization gave rise to furan-2-one **40** in moderate yield (Scheme 10).¹⁵

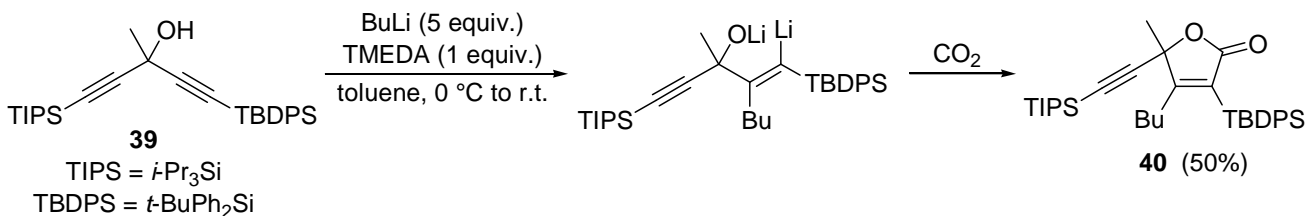

Scheme 10

3. Intramolecular reactions

The intramolecular carbolithiation reaction of organolithiums onto an unactivated olefinic or acetylenic bond is a useful methodology for the preparation of cyclopentylmethylolithium derivatives, their heterocycles analogues and, less effectively, the corresponding six-membered rings. Although the isomerization of 5-hexenylolithium **42** to cyclopentylmethylolithium **43** was first reported in the late 1960s by Drozd and co-workers,¹⁶ it was in 1985 when Bailey and co-workers reignited interest in anionic cyclization reactions of organolithium onto alkenes. They showed that the iodine-lithium exchange of primary alkyl iodides like **41** with *t*-BuLi at -78 °C did not take place *via* radical intermediates and they studied the kinetics of the intramolecular carbolithiation of **42** to **43** (Scheme 11).¹⁷

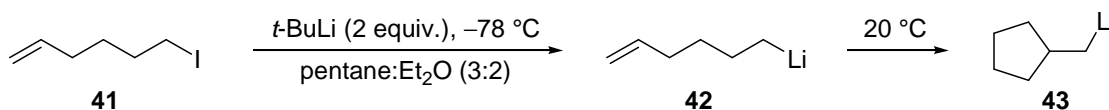

Scheme 11

Despite the fact that an energetically less favourable sp^2 to sp^3 carbanion transformation is involved, both vinyl and aryllithium cyclization reactions onto alkenes are successful. The first example was due to Woolsey and co-workers, who reported the carbolithiation of 2-(3-butenyl)phenyllithium **44** to 1-lithiomethylindane **45** that was characterized by deuteriolysis (Scheme 12).¹⁸

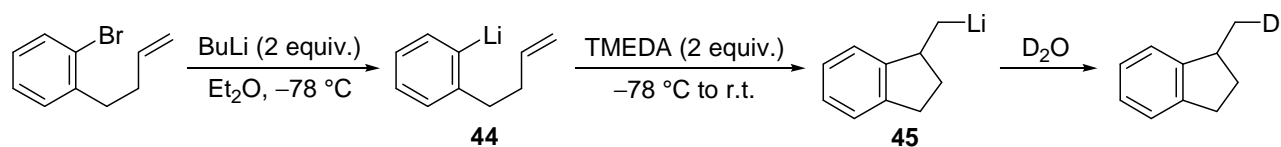

Scheme 12

Although all these carbolithiation reactions are thermodynamically favourable processes, in many cases the isomerizations are sluggish at room temperature and the presence of lithiophilic Lewis bases such as THF or TMEDA serves to increase the rate of the cyclization reactions.

On the other hand, the intramolecular carbolithiation of 5-hexynyllithiums **46** are *syn*-stereospecific processes and the rate of the reaction is dependent on the substituent of the triple bond, being the cyclization of **46b** 10^6 times slower than the cyclization of **46a**. Functionalized cyclopentylidene-containing products **47** are obtained by this strategy (Scheme 13).¹⁹

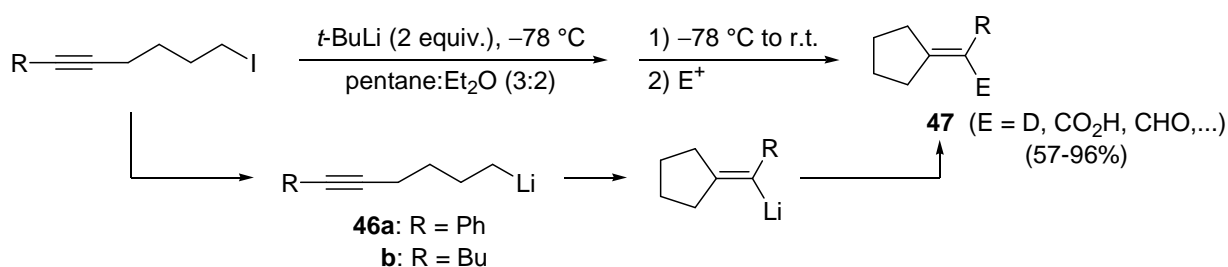

Scheme 13

3.1. Special features of intramolecular carbolithiation reactions

3.1.1. Stereoselectivity and mechanism

One general aspect to consider about intramolecular carbolithiation reactions is that the generation of the starting organolithium might not involve radical intermediates or, alternatively, if its formation takes place *via* single-electron transfer processes, the capture of the second electron must be faster than the radical cyclization reaction. If not, observed cyclization could be of radical nature. Carbolithiation reactions have two important advantages over the corresponding radical cyclization. Whereas it is not generally possible to trap the radical intermediate, the corresponding cyclized organolithium intermediate could be trapped with electrophiles affording functionalized compounds. Moreover, carbolithiation reactions are much more stereoselective than the analogous radical-mediated cyclization reactions.²⁰ The contrast in regio- and stereoselectivity for the cyclization of related organolithium **48** and radical **49** is shown in Scheme 14.²¹

The observed regioselectivities and stereoselectivities of the intramolecular addition of a C–Li bond to an unactivated alkene could be rationalized by recourse to a transition-state model that resembles a cyclohexane chair in which substituents preferentially occupy pseudo-equatorial positions (Scheme 15).^{20,21} *Ab initio* molecular-orbital calculations carried out by Bailey and co-workers reveal that the regio- and

stereochemistry of the isomerization of substituted 5-hexen-1-yllithium compounds **50a–c** is a consequence of an energetically favorable coordination of the lithium atom of the substrate with the remote π -bond.²⁰

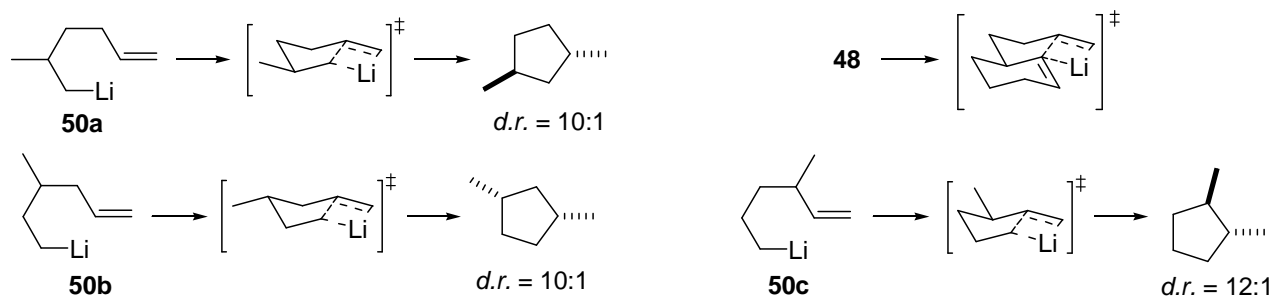
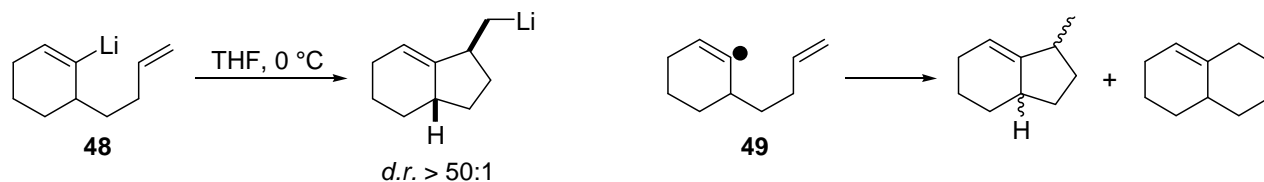

On the other hand, the control of absolute stereochemistry in the intramolecular carbolithiation reactions is not a completely solved aspect and different approaches have been used as we will show along this review: (a) a “chiral auxiliary” approach with the presence of an exocyclic stereocentre of defined configuration in the starting substrate to direct the cyclization; (b) a “chiral substrate” approach with the use of a configurationally defined and stable organolithium starting material, usually generated by stereospecific tin-lithium exchange or by enantioselective deprotonation; (c) a “chiral ligand” approach with the use of an external ligand such as (–)-sparteine to confer enantiofacial selectivity in cyclizations of achiral olefinic organolithiums. The first example of an enantioselective carbolithiation reaction with (–)-sparteine was reported by Marek, Normant and co-workers (see Scheme 3).^{8a}

3.1.2. Scope and limitations

Although some examples of the formation of three-, four-, and six-membered rings by an intramolecular carbolithiation reaction have been reported, this methodology could only be considered as general for the generation of five-membered carbocycles and heterocycles. One of the major drawbacks of these anionic cyclizations is that they are limited to terminal double bonds and this is a key point of divergence from radical cyclizations. However, it has been possible to obtain cyclized products from 1,2-disubstituted olefins when the formed allyllithium product is substituted with a leaving group in a β -position leading to an elimination reaction of the organolithium.²² This type of processes could also be considered as intramolecular S_N' cyclization reactions. Moreover, the presence of a moderately activating group like phenyl, trimethylsilyl, cyclopropyl, arylthio, or alkynyl at the terminal position of the olefin also favors the cyclization, probably due to the stabilization of the resulting cyclized organolithium by these activating substituents.²³ In recent years, we have developed an intramolecular carbolithiation reaction of lithiated double bonds, a conceptually new process that expands the scope of this kind of reaction. This

cyclization is general with respect to the moiety of the starting material and that simple 2,6-dilithio-1,6-heptadienes are useful substrates. Moreover, *ab initio* molecular orbital calculations show Li–C interactions in the transition state and support a carbolithiation pathway for the cyclization of 2,6-dilithio-1,6-heptadiene derivatives.²⁴

On the other hand, for the carbolithiation of alkynes, an obvious limitation is that terminal alkynes are always deprotonated by organolithium reagents. In addition, in some cases deprotonation of propargylic positions could also occur more readily. With silyl or aryl stabilizing substituents on the triple bond, it was also possible to prepare four- and six-membered ring by *exo-dig* cyclization reactions. Although these intramolecular carbolithiation reactions of alkynes are *syn*-stereospecific processes, the resulting vinylolithium species could be more or less configurationally stable at the temperature required for the cyclization to take place.²⁵

3.2. Synthesis of furan derivatives

The anionic cyclization of α -alkoxyolithium derivatives, pioneered by Broka and co-workers, provides an expedient and stereoselective route to a variety of tetrahydrofurans not easily available by other means. Treatment of homoallylic tributyltinmethyl ether derivatives **51** with BuLi generates the corresponding α -alkoxyorganolithiums, which on warming undergo a carbolithiation reaction to afford *cis*-2,4-disubstituted tetrahydrofurans **52** (Scheme 16).²⁶ A cyclohexane chair-like transition state **53** could be considered to account for the observed stereoselectivity. Although, as above mentioned, a major drawback of the carbolithiation reactions of olefinic organolithiums is that they are limited to terminal alkenes, the strategy of using a 1,2-disubstituted olefin bearing a leaving group in a β -position was first used by these authors. In this way, the tin-lithium exchange on appropriate starting ethers **54** gave rise to vinyl tetrahydrofurans **55** in excellent yield and in a highly *cis*-selective way. The presence of a leaving group at the distal allylic position enhances not only the yield of the cyclized product but the stereoselectivity as well (Scheme 16).²⁶

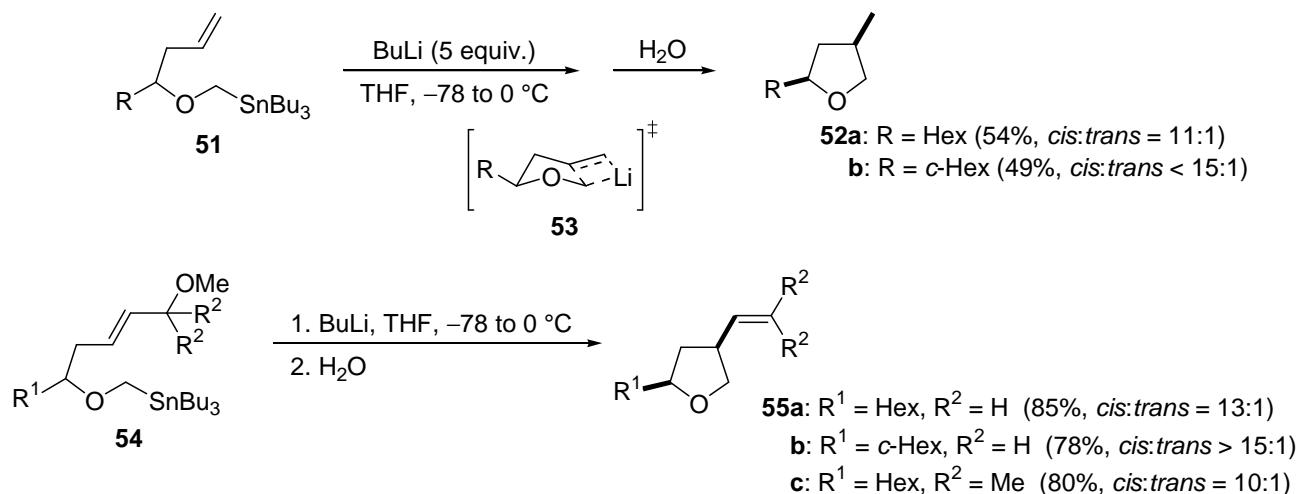

Scheme 16

In order to expand the scope of this methodology, the same authors have used a reductive lithiation as an alternative strategy for the generation of α -alkoxyorganolithiums. Upon treatment of the α -(phenylthio) ether **56a** with lithium naphthalenide, anionic cyclization took place smoothly to yield the 2,3-disubstituted

tetrahydrofuran **57** with good *trans*-stereoselectivity and moderate yield (Scheme 17).²⁷ Again, the presence of a good leaving group at the β -position of the cyclized organolithium led to the final tetrahydrofuran derivative **58** in considerably improved chemical yield (Scheme 17).²⁷ The high *trans*-selectivity of these reactions supports the anionic, rather than radical, character of these cyclizations.

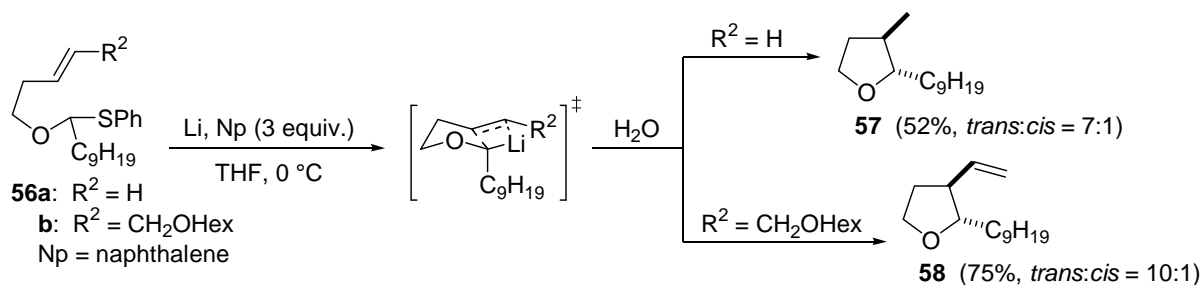

Scheme 17

Lautens and Kumanovic have applied this methodology to the synthesis of oxabicyclo[5.3.0]decenes **60** bearing up to five contiguous stereocentres with complete regio- and stereocontrol. They have shown that oxabicyclo[3.2.1] compounds **59** are available in few steps from substituted furans *via* a [4+3] cycloaddition reaction. Their treatment with excess of MeLi at low temperature generated the corresponding α -oxy-organolithium species that upon warming underwent cyclization leading to cyclohepta[*c*]furan derivatives **60** in good yields. Their stereochemistry is consistent with an intramolecular anionic attack of the olefin in an *exo* S_N2' fashion (Scheme 18).²⁸

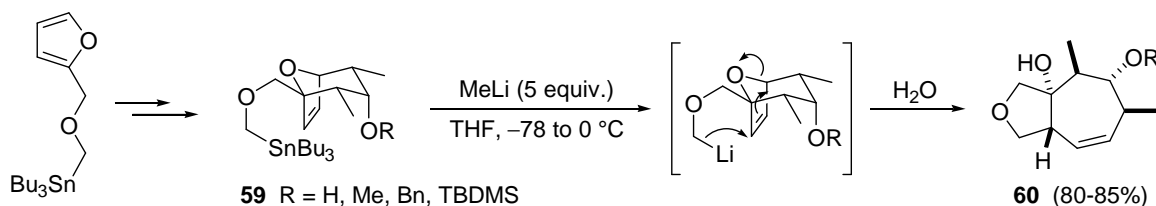

Scheme 18

Nakai and co-workers have shown evidences for retention of configuration at the carbanionic centre in the carbolithiation reaction of enantio-enriched α -(homoallyloxy)alkyllithiums, generated by tin-lithium exchange from enantio-defined stannanes **61**. In this way, *trans*-2,3-disubstituted tetrahydrofuran derivatives **62** and **63** have been prepared with high diastereoselectivity and without losing the enantiomeric purity. The addition of LiCl in the case of **61a** considerably improved the yield of the cyclization by minimizing coordination of the lithium atom with the ether oxygen (Scheme 19).²⁹

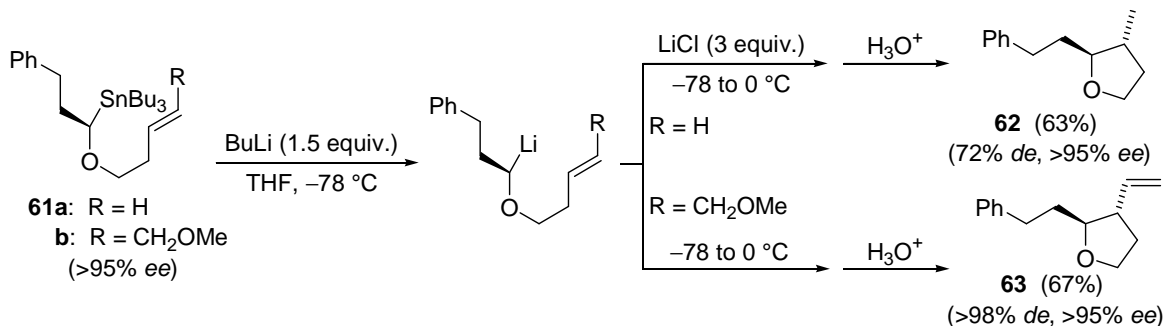

Scheme 19

Taking advantage from the known fact that tertiary nitriles can be reductively cleaved to form alkyllithium reagents,³⁰ Rychnovsky and co-workers have probed that reductive decyanation cyclizations take place through an anionic rather than a radical cyclization. They have described that the reductive lithiation of enantiomerically pure nitrile **64** with excess of lithium di-*t*-butylbiphenylide (LiDBB) led to the spirocyclic product **66** as a single diastereoisomer in 42% *ee*, through the intermediacy of organolithium **65** (Scheme 20).³¹ It has been shown that the lifetime of the intermediate radical is too brief to allow a radical cyclization and thus the cyclization proceeds through the alkyllithium intermediate **65**.

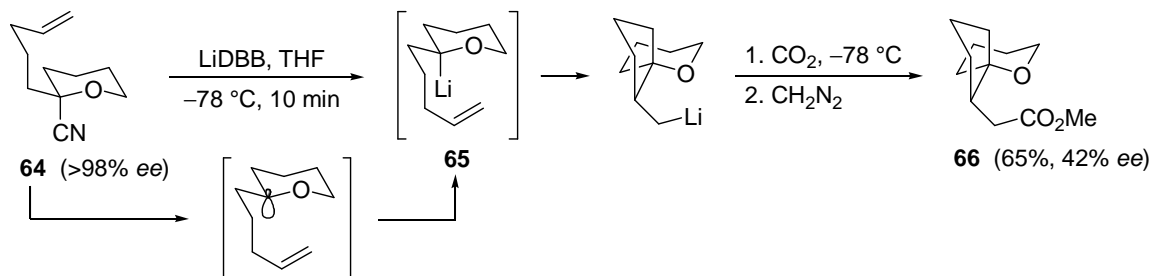

Scheme 20

This strategy has been further developed for the spiroannulation of tetrahydropyran rings. The 2-cyanotetrahydropyran **67** was easily prepared from δ -decanolactone and its alkylation reactions produced cyclization precursors **68**, **70** and **72** with complete selectivity in favor of the axial nitrile. Addition of **68** to excess LiDBB in THF at -78 °C and warming immediately to *ca.* -40 °C led to cyclization of the alkyllithium intermediate. Trapping the cyclized organolithium with CO_2 and subsequent esterification yielded spirocyclic ester **69** as a single diastereoisomer (Scheme 21).³²

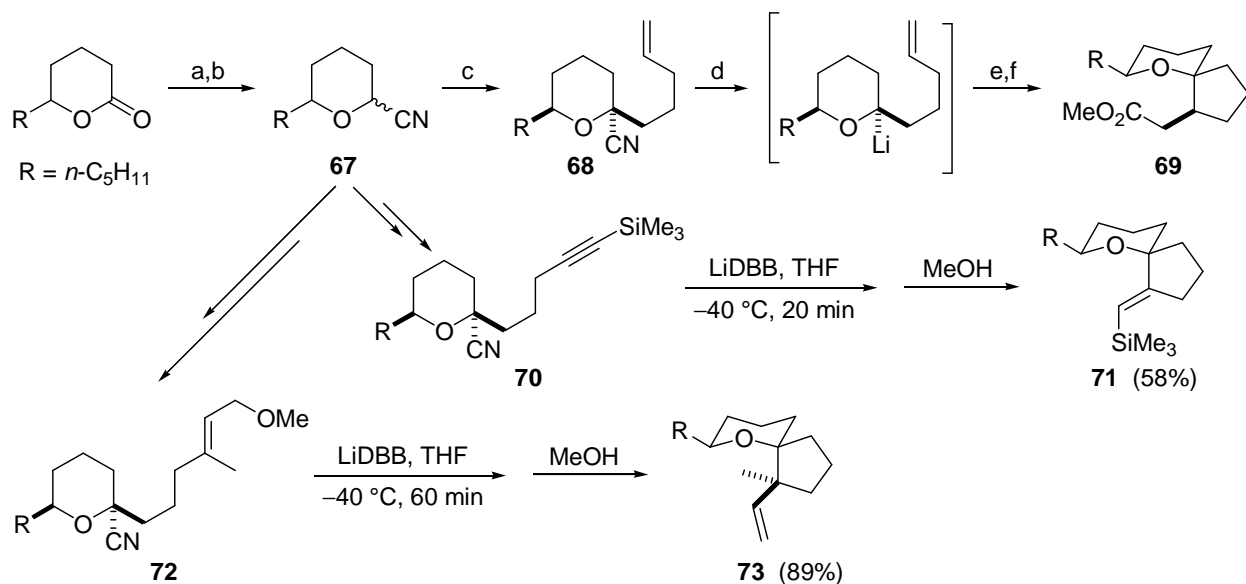

(a) 1. DIBAL-H, -78 °C; 2. Ac_2O , DMAP, Py; (b) TMS-CN, $\text{BF}_3 \cdot \text{OEt}_2$, 91%; (c) LDA, -40 °C, THF, DMPU, then $\text{I}(\text{CH}_2)_3\text{CH}=\text{CH}_2$, 86%; (d) LiDBB (excess), THF, -78 to -40 °C; (e) CO_2 ; (f) CH_2N_2 , 75% from **68**.

Scheme 21

In an analogous way, the spirocyclization of **70** delivered **71** in moderate yield due to competitive reductive decyanation and alkyne reduction side products. Moreover, the possibility to form two adjacent

quaternary centres was tested with nitrile **72**. An efficient cyclization produced spirocycle **73** as a single diastereoisomer (Scheme 21). For each of the alkene cyclizations, the diastereoisomer with the alkyl chain *cis* to the THP oxygen atom was formed exclusively.³²

Rychnovsky and co-workers have developed a rational synthesis of contra-thermodynamic spiroacetals by using their above-described methodology. α -Thiophenyl ketene acetal **74**, prepared from the corresponding enol ether by deprotonation and reaction with Ph_2S_2 , reacts with the corresponding optically pure diol leading to a spiro *ortho* ester that was cleaved by treatment with TMSCN affording, after hydrolysis and reprotection, the cyanoacetal **75** as a mixture of stereoisomers. The reductive cyclization of **75** proceeds in good yield on treatment with LiDBB leading to a single diastereomer of spiroacetal **76** (Scheme 22).³³ In the same way, cyano acetal **77** was synthesized from **74** and its reductive lithiation followed by cyclization onto the methoxy alkene produced spiroacetal **78** in excellent yield as a single diastereomer. On treatment with CSA , **78** equilibrated quantitatively to the epimeric spiroacetal, confirming that this is the contra-thermodynamic spiroacetal (Scheme 22).³³

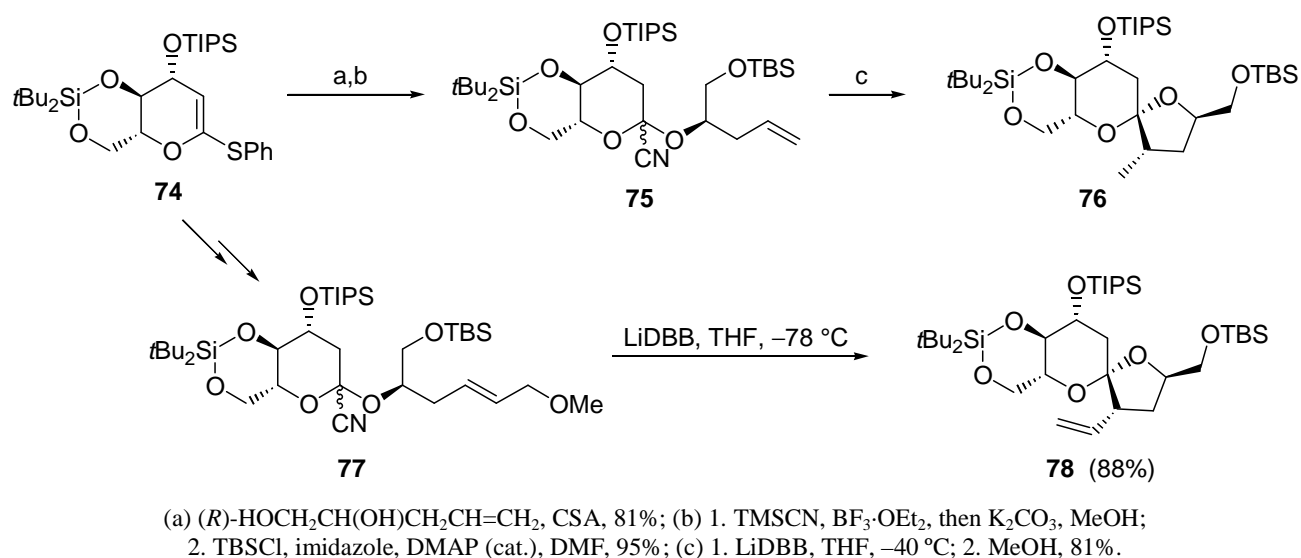

Scheme 22

3.3. Synthesis of benzofuran derivatives

The first report about the synthesis of a benzo[*b*]furan derivative through a carbolithiation reaction is due to Baldwin and co-workers, who in 1980 described the preparation of (2,3-dihydrobenzo[*b*]furyl)acetanilides **80** by metalation of 3-allyloxybenzanilides **79** although the yield was not reported (Scheme 23). The most probably reaction pathway starts with an *ortho*-lithiation process giving a dilithium intermediate, which undergoes a carbolithiation reaction affording a 3-lithio-methyldihydrobenzo[*b*]furan **81**. This intermediate could undergo an intramolecular attack onto the amide group and subsequent Haller-Bauer-type cleavage giving rise to the final products (Scheme 23).³⁴

In the context of achieving a selective metal-halogen exchange in polybromoanisoles,³⁵ Nishiyama and co-workers have synthesized a cyclopenta[*b*]benzofuran **83** from bis(2-bromophenoxy)-cyclopentene **82**, through a $\text{S}_{\text{N}}2'$ intramolecular cyclization, which could also be considered as a carbolithiation reaction followed by a β -elimination process (Scheme 24). Later on, the same authors tried to improve this transformation as an asymmetric reaction by addition of chiral auxiliaries. (–)-Sparteine afforded **83** in 74%

yield, but which proved to be a racemic form. Gratifyingly, the addition of a chiral monolithium naphthoxide produced the desired benzofuran **83** with high enantioselectivity (Scheme 24).³⁶ Starting from a commercially available (+)-(1*S*,4*R*)-*cis*-4-acetoxy-2-cyclopenten-1-ol, sequential Mitsunobu reactions gave rise to *o*-bromophenyl ether **84**. Upon treatment with BuLi, the enantiomerically pure cyclopenta[*b*]benzofuran **83** was obtained in 55% yield (Scheme 24).³⁷ This compound has been used as a key intermediate in the synthesis of stable prostacyclin (PGI₂) analogues.³⁸

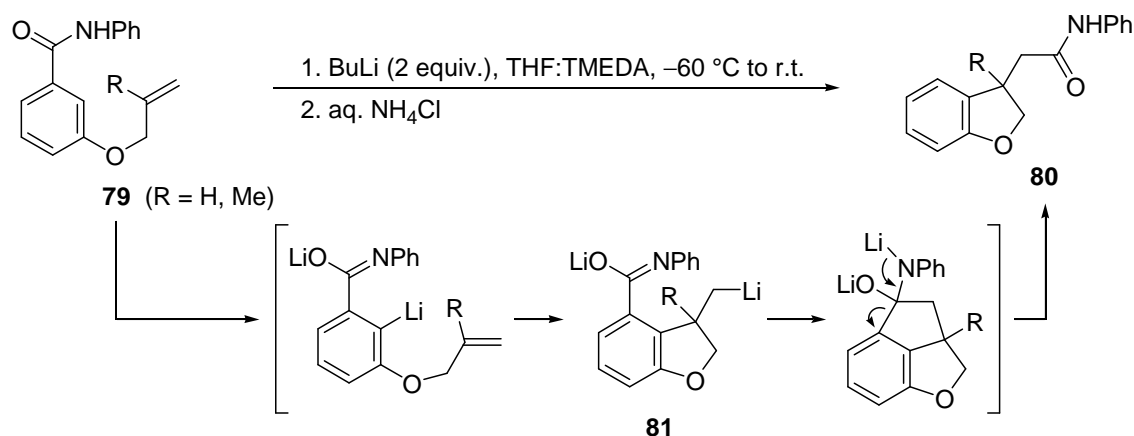

Scheme 23

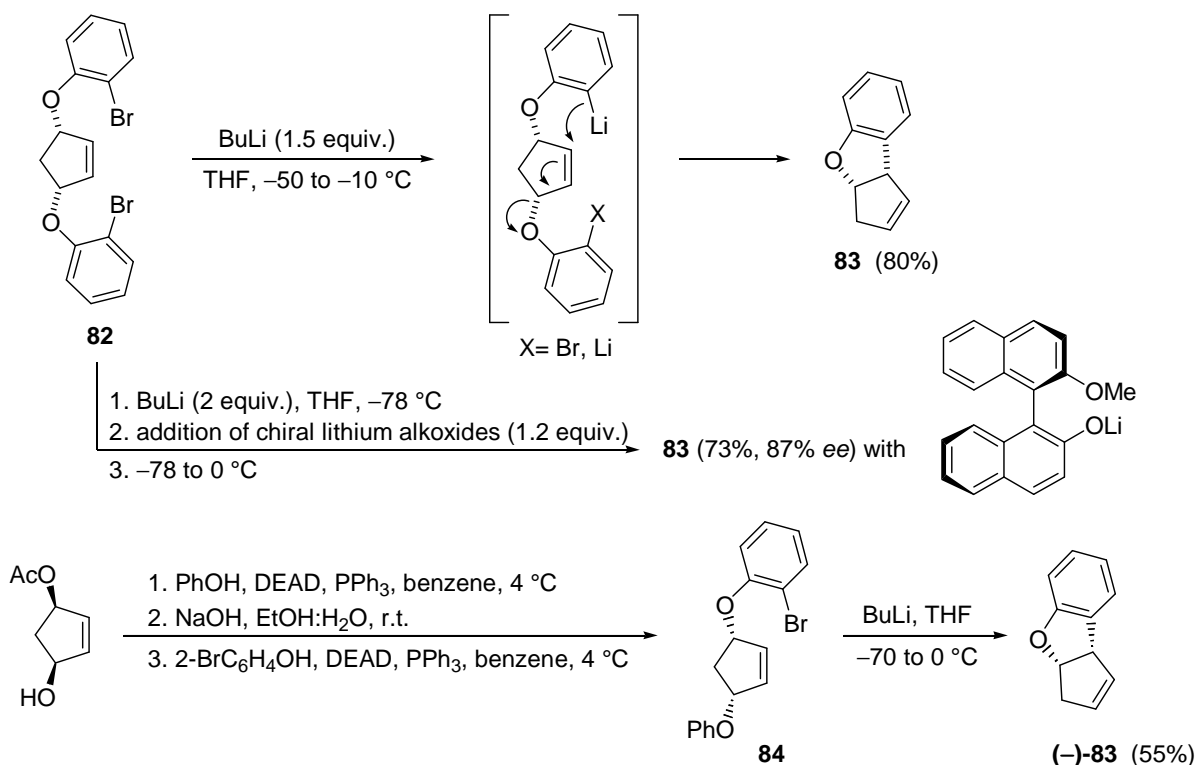

Scheme 24

However, when simple 3-methyl-2,3-dihydrobenzo[*b*]furan was tried to be prepared by intramolecular carbolithiation of allyl 2-lithiophenyl ether **85**, Bailey and Punzalan found that *o*-cyclopropylphenol **86** was generated. A γ -elimination reaction in the intermediate (2,3-dihydrobenzo[*b*]furanyl)methylolithium accounts for this unexpected result. Moreover, **86** was obtained in low yield probably due to a competitive cleavage of

the allyl group in **85** by the excess of *t*-BuLi (Scheme 25).³⁹ In this field, we have reported that *o*-bromoaryl 3-trimethylsilyl-2-propenyl ethers **87** underwent a similar tandem carbolithiation/ γ -elimination reaction upon bromine-lithium exchange and further addition of TMEDA giving rise to *o*-cyclopropyl phenol or naphthol derivatives **88** in good yields and in a diastereoselective manner (Scheme 25).⁴⁰ The *trans*-1-aryl-2-trimethylsilylcyclopropane derivatives **88** are the major products independently of the configuration of the allylic double bond, showing that a rapid epimerization of the organolithium intermediate prior to the 1,3-elimination has taken place. In addition, the use of (–)-sparteine instead of TMEDA allows the synthesis of cyclopropane derivatives **88** with up to 81% *ee* when non-polar solvents such as toluene was used instead of Et₂O (Scheme 25).⁴⁰

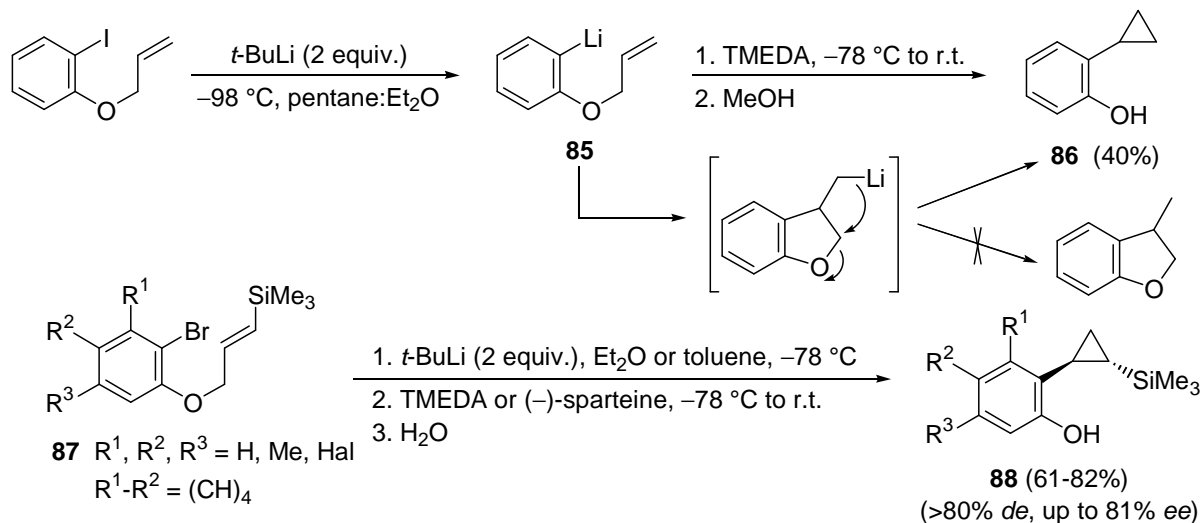

Scheme 25

In spite of these discouraging results, we have further investigated the possibility of accessing dihydrobenzo[*b*]furan derivatives from allyl *o*-lithioaryl ethers through carbolithiation reactions. To this end, it was necessary to find the appropriate conditions to avoid the 1,3-elimination reaction referred above. Although we found that ether **89a** was able to afford functionalized dihydrobenzo[*b*]furan derivatives **90a** (R=H) in low yields under careful control of the reaction conditions, we concluded that the γ -elimination is not slow enough compared with the carbolithiation reaction and therefore it was not possible to obtain selectively compounds **90** (Scheme 26).

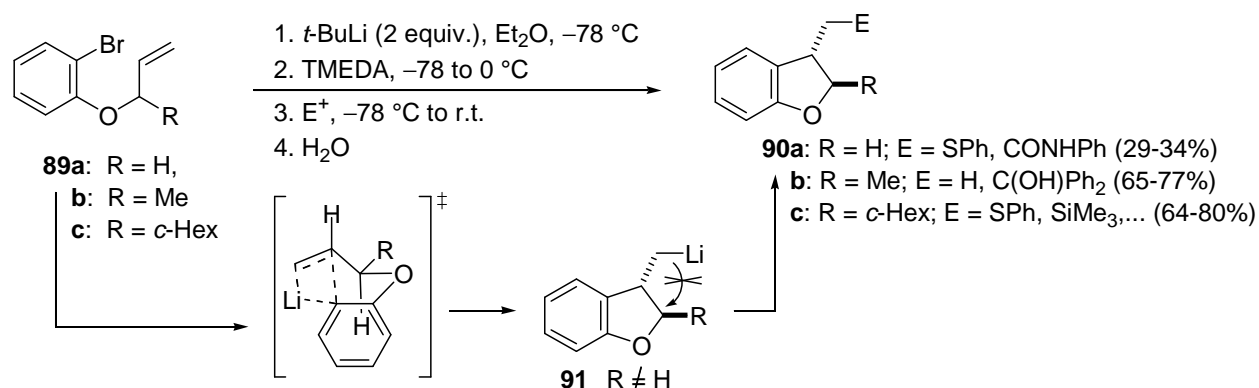

Scheme 26

Pleasingly, the presence of substituents at the α -position of the allyl moiety, (**89b,c**) allows the synthesis of functionalized *trans*-2,3-dihydrobenzo[*b*]furans **90b,c** in good yields and with total diastereoselectivity, which could be explained by a transition state that accommodates the R group in a pseudoequatorial position (Scheme 26).⁴¹ Probably, the steric effect of the R substituent avoids the 1,3-elimination process in intermediate organolithium **91**. Moreover, starting from (*R*)-**89b**, the first enantioselective synthesis of (*2R,3S*)-*trans*-2,3-dimethyl-2,3-dihydrobenzo[*b*]furan **90b** (E=H) has been achieved (Scheme 26).⁴¹

We also found that simple allyl ethers **92**, bearing an alkyl or trialkylsilyl substituent at the 6-position of the aryl moiety, were useful substrates for the synthesis of functionalized dihydrobenzo[*b*]furan derivatives **93**. We tentatively proposed that this substituent exerts a stereoelectronic effect that favors the carbolithiation reaction and inhibits the 1,3-elimination process (Scheme 27).⁴¹ Interestingly, ether **92** (with R¹=SiMe₃ and R²=H) behaves as synthetic equivalent of the parent ether **89a** because the trimethylsilyl group can be removed under mild conditions with HBF₄ (Scheme 27). In this way, 3-functionalized-2,3-dihydrobenzo[*b*]furan derivatives **90a**, which have no substituents at the 2- and 7-positions of the benzo[*b*]furan moiety, can be synthesized in good yields, avoiding the careful control of the temperature and the low yields obtained with ether **89a** (see Scheme 26). In addition, when (–)-sparteine was used instead of TMEDA, the cyclization reaction takes place in an enantioselective way and so, enantio-enriched 2,3-dihydrobenzo[*b*]furans **93** were obtained with up to 87% *ee* (Scheme 27).⁴¹ The absolute configuration of the stereogenic centre of the major enantiomer was determined by correlation of **93** (R¹=SiMe₃; R²=H; E=Me) with (–)-(*R*)-2-*sec*-butylphenol.

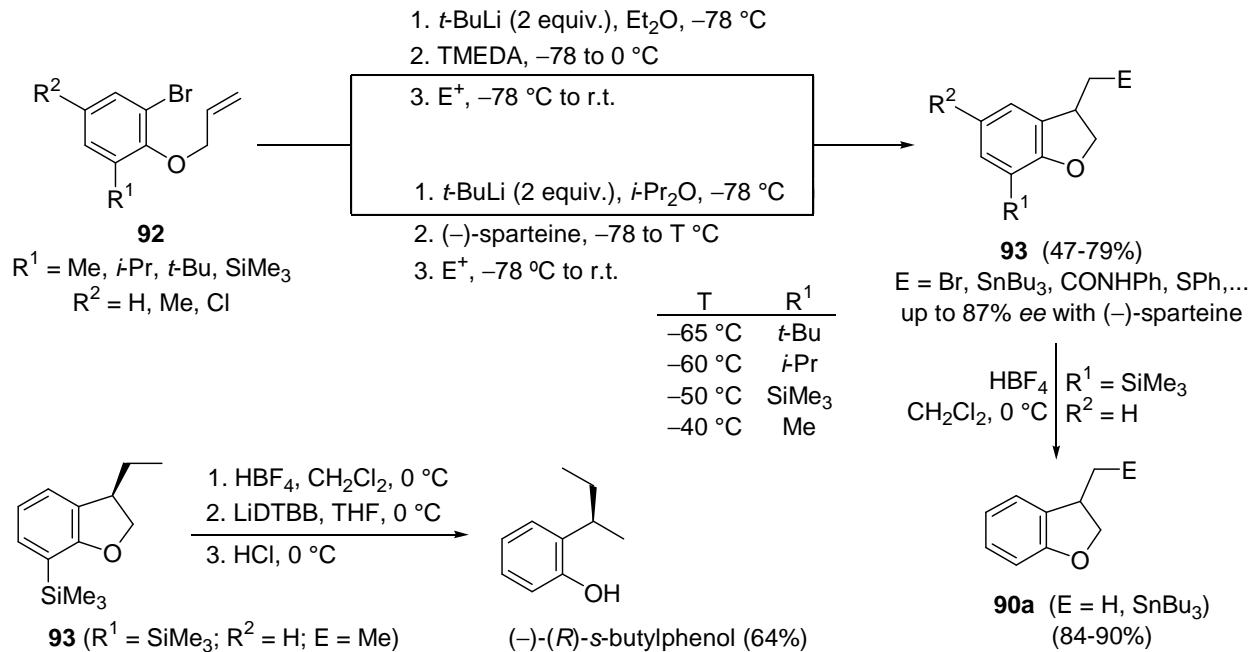

Scheme 27

However, when a chlorine atom is present at the 6-position of the starting 2-bromophenyl ether, such as **94**, the *o*-cyclopropylphenol derivative **95** was exclusively obtained (Scheme 28).⁴¹ The electron-withdrawing effect of the chlorine atom could favor the γ -elimination process by decreasing the electron density on the oxygen atom. On the other hand, 6-methoxy-substituted ether **96** gave rise under standard

conditions to a *ca.* 1:1 mixture of the dihydrobenzo[*b*]furan derivative **97** and *o*-methoxyphenol **98**. We thought that the presence of the methoxy group at the *ortho* position with respect to the allyloxy moiety could favor a competitive intermolecular carbolithiation reaction of *t*-BuLi onto the double bond. We have taken advantage of this result by developing a selective *O*-deallylation reaction of allyl *o*-methoxyphenyl ethers (Scheme 28).⁴²

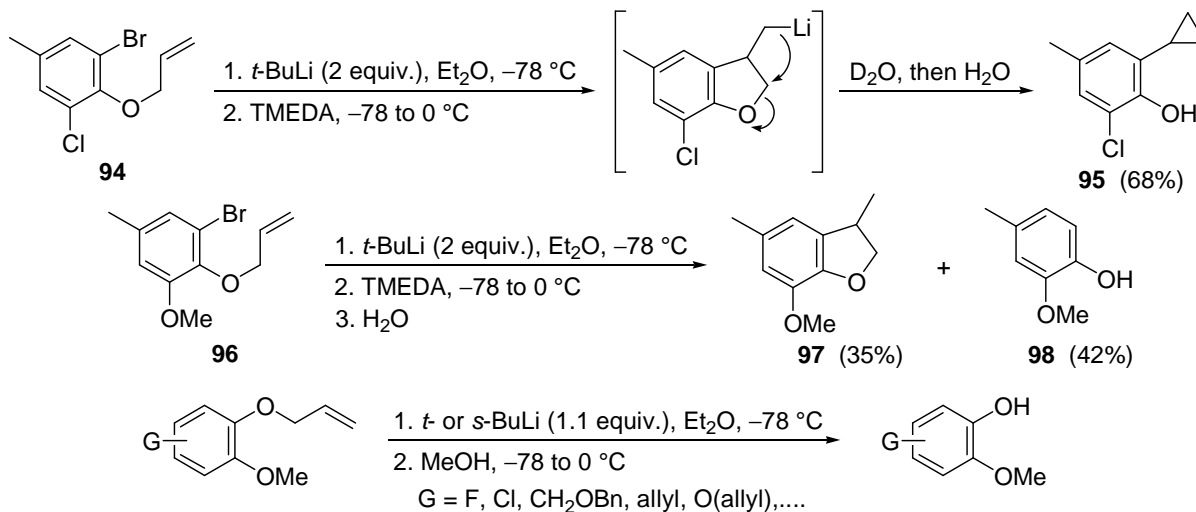

Scheme 28

2,3-Disubstituted benzo[*b*]furans **101** have been synthesized by treatment of trifluoroethyl ether **99** with excess of alkyl lithium compounds. A 5-*endo-dig* carbolithiation reaction on acetylene derivative **100**, generated by two successive elimination reactions, is proposed to explain the formation of the 2-lithiated benzo[*b*]furan, which is finally trapped with electrophiles (Scheme 29).⁴³

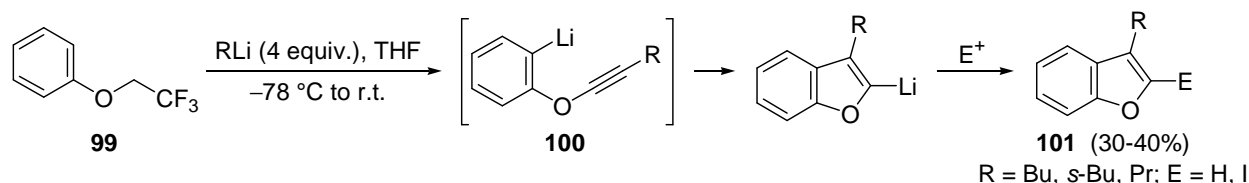

Scheme 29

Maddaluno and Le Strat have reported a new access to 3-vinylbenzo[*b*]furans **103a** and 3-vinylfuro[3,2-*b*]pyridines **103b** (Scheme 30).⁴⁴ Halogen-lithium exchange on ethers **102** triggers an irreversible anionic cascade based on a 5-*exo-dig* carbolithiation followed by a lithium ethoxide elimination and subsequent isomerization of the exocyclic allene. These authors also reported that the corresponding furo[2,3-*c*]pyridines **106** could be synthesized in a similar way, but a previous isomerization of the starting acetylenic ether **104** to the corresponding allenyl ether **105** with *t*-BuOK is necessary, in order to avoid competitive deprotonation at the propargylic centre (Scheme 30).^{44b} Later on, when these authors tried to characterize some of the intermediates along the reaction pathway which affords 3-vinylbenzo[*b*]furan **103a**, they treated the more stable 2-bromophenyl ether **107** with exactly one equiv. of BuLi at $-78\text{ }^{\circ}\text{C}$ in THF. Surprisingly, they found that dihydrobenzo[*b*]furan **109** was obtained solely as the *E*-isomer, which suggested that addition to the alkyne had occurred in an unprecedented *anti* fashion. DFT calculations show

that this unexpected characteristic is related to the intramolecular coordination of the lithium atom by one oxygen atom of the terminal acetal appendage (Scheme 30).⁴⁵ Disappointingly, intermediate vinyl lithium **108** showed very low reactivity and attempts to trap it with electrophiles were unsuccessful. Moreover, its treatment with EtOD led to only 34% of deuterium incorporation in the final product **109**.

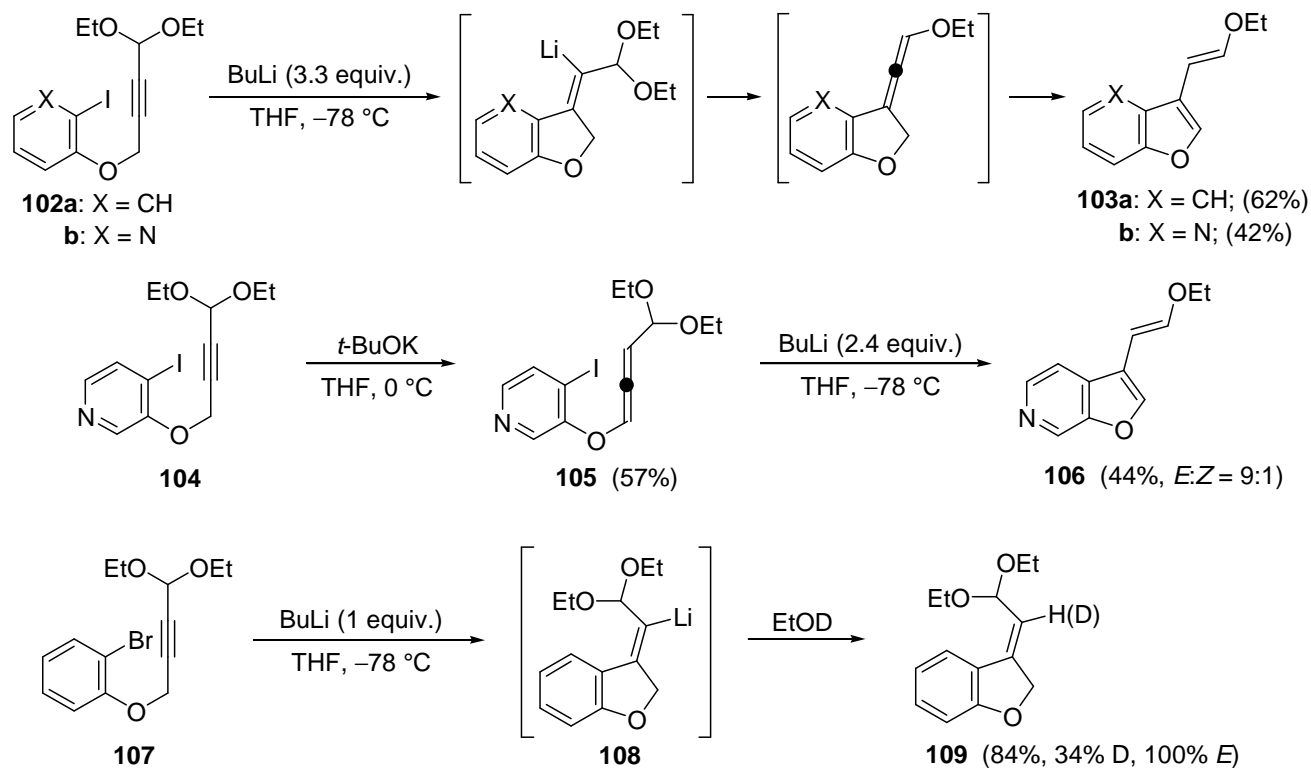

Scheme 30

3.4. Synthesis of pyrrole derivatives

The preparation of 3-alkylpyrrolidines by intramolecular carbolithiation of *N*-homoallyl α -amino-organolithium compounds has been extensively studied by the Coldham group. They have used the tin-lithium exchange method for the generation of the organolithium. For example, as depicted in Scheme 31, aminomethylstannane **110a** gave rise to pyrrolidine **112** probably by way of the lithiomethyl intermediate **111**.⁴⁶

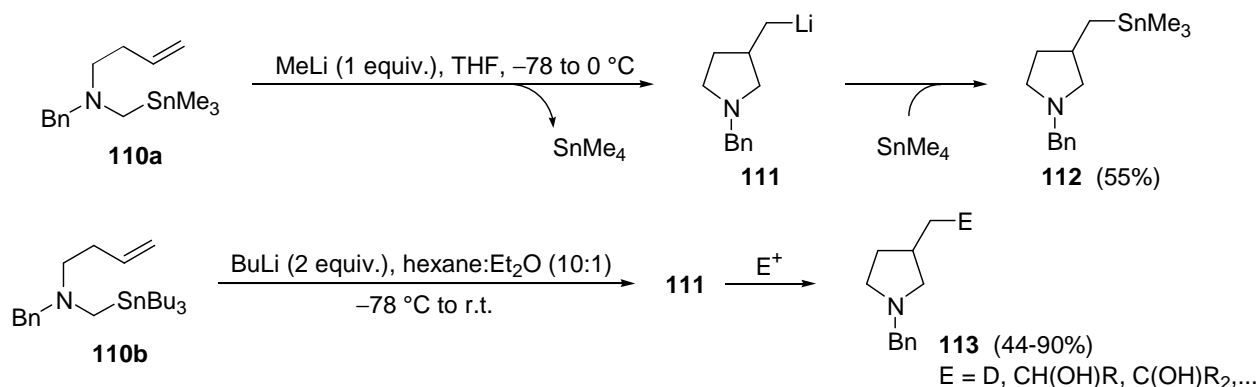

Scheme 31

The overall transformation of **110a** into **112** is a rearrangement and can be promoted with substoichiometric amounts of MeLi in the presence of Me₄Sn. On the other hand, the use of the tributylstannane derivative **110b** allows the synthesis of a variety of 3-functionalized pyrrolidines **113** by treatment of **111** with different electrophiles (Scheme 31).⁴⁷

When α -substituted homoallylic amines **114** were used as substrates, the cyclization resulted in the formation of 2,4-disubstituted pyrrolidines **115** with high selectivities in favor of the *cis* isomers (Scheme 32).⁴⁸ Although almost total diastereoselectivity was observed in THF, higher chemical yields were obtained in hexane:Et₂O at the expense of stereoselectivity. Using a “chiral auxiliary” approach to control the stereoselectivity, the use of a chiral α -methylbenzylamine **116** gave rise to 3-methylpyrrolidine **117** with 48% *de* and with up to 58% *de* carrying out the cyclization in the presence of (–)-sparteine. Disappointingly, by using the “chiral ligand” approach with the use of an external ligand like (–)-sparteine to confer enantiofacial selectivity in the cyclization of an achiral olefinic organolithium, the cyclization of stannane **110b** took place with only low levels of enantioselectivity (Scheme 32).⁴⁸

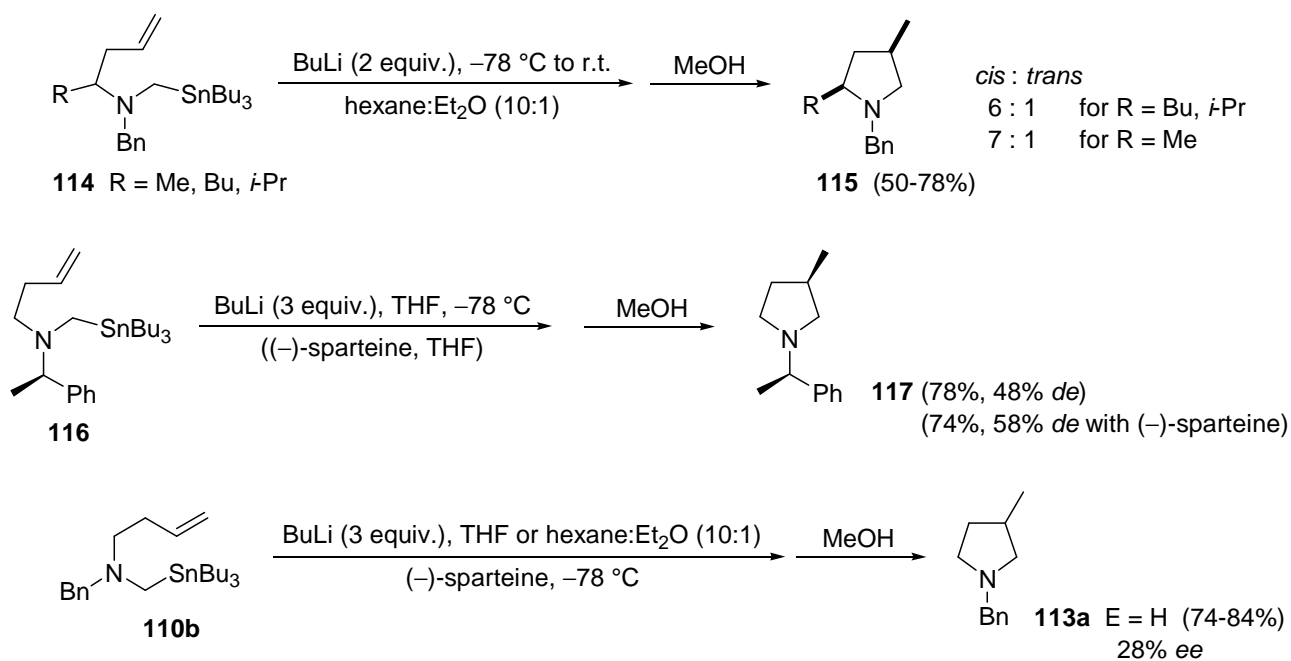

Scheme 32

In this context, 3-alkenylpyrrolidines **119** could be prepared by anionic cyclization of α -amino-methylstannanes **118** with a pendant allylic ether in their moiety (Scheme 33).⁴⁹ In this case, the intramolecular carbolithiation reaction affords a β -oxygen functionalized organolithium intermediate that undergoes a β -elimination of lithium alkoxide. Coldham and co-workers have applied this methodology to the synthesis of an advanced intermediate **121** related to the natural product (–)- α -kainic acid. The crucial tin-lithium exchange and cyclization were carried out on stannane **120** by its treatment with BuLi in hexane:Et₂O (4:1) (Scheme 33).^{49b} Although the desired pyrrolidine product **121** was formed in reasonable yield, the major diastereoisomer has not the required stereochemistry across C-3 and C-4 for the synthesis of kainic acid. Surprisingly, the major product has the opposite stereochemistry to the expected one according with a preferred chair-shaped transition state.

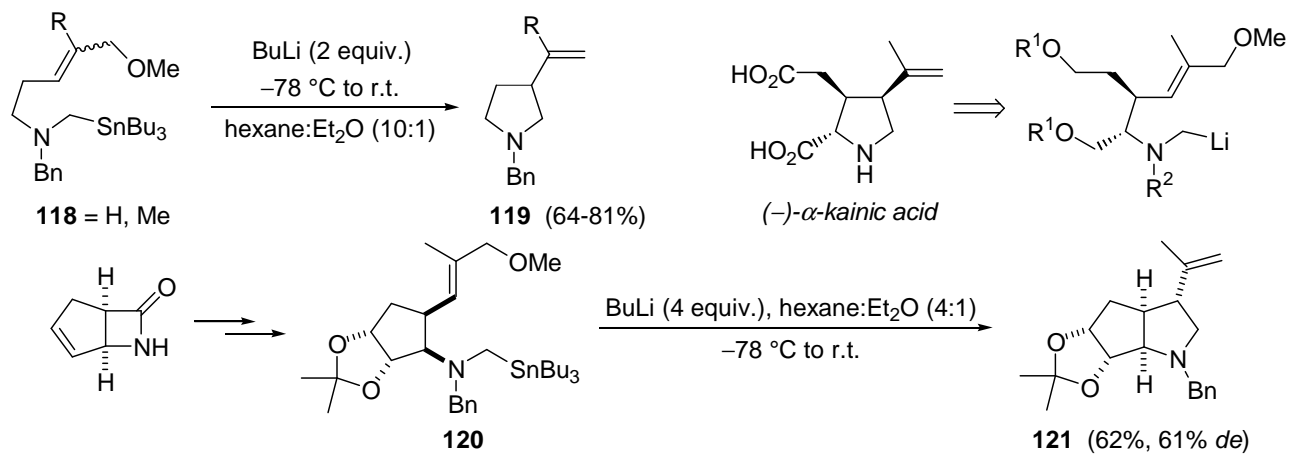

Scheme 33

Coldham and co-workers also reported that alkyne **122**, which was prepared en route to the allylic ether **118**, underwent intramolecular carbolithiation giving rise to the 3-trimethylsilylmethylene pyrrolidine **123** that was isolated as a mixture of geometrical isomers (Scheme 34).^{49a} Probably, the anionic cyclization occurs to give initially only the *E*-vinyl lithium intermediate, which can isomerize to the *Z*-isomer.

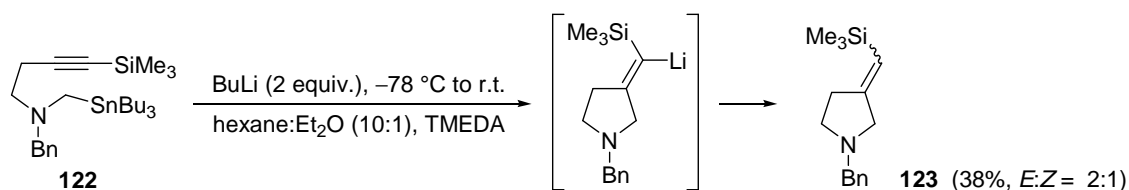

Scheme 34

Our research group has been interested in the use of *N*-(2-lithioallyl)amines as useful intermediates in several metal-mediated organic transformations.⁵⁰ In the field of carbolithiation reactions, we have reported that *N*-allyl-*N*-(2-lithioallyl)amines **124**, easily generated by bromine-lithium exchange at low temperature in Et₂O, undergo a 5-*exo* cyclization in the presence of TMEDA. After quenching with electrophiles, 3-functionalized-4-methylenepyrrolidines **125** were isolated in good yields (Scheme 35). However, the course of the reaction seems to depend on the nitrogen electron density and so, when the *N*-substituent is aromatic, the major products are the secondary amines **126**.⁵¹

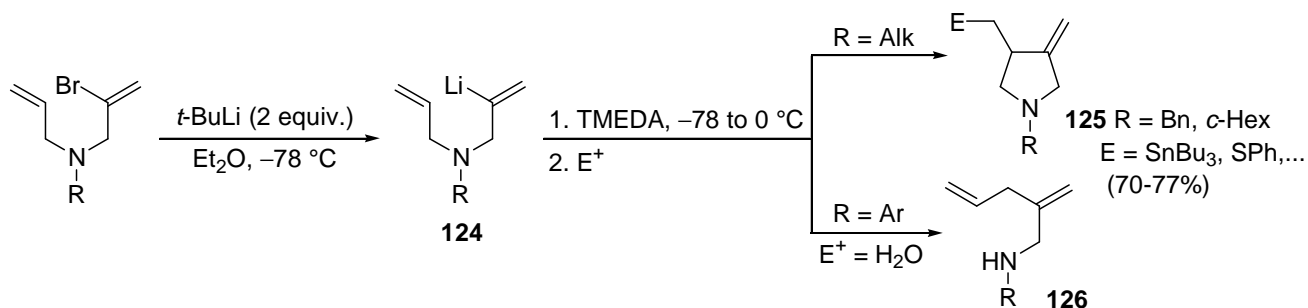

Scheme 35

Initially, we proposed a 6-*endo* cyclization to account for the generation of amines **126**. However, later on we have designed experiments to show that the intramolecular carbolithiation of aromatic *N*-allyl-*N*-(2-

lithioallyl)amines **124** (R=Ar) takes place through a 5-*exo* cyclization and further rearrangement of the intermediate lithiomethylpyrrolidines **127** via a cyclopropyl derivative **128**, which undergoes rapid and irreversible fragmentation to the lithium amide of **126** (Scheme 36). In this way, a variety of functionalized aromatic methylenepyrrolidines **125** (R=Ar) have been synthesized by trapping lithiomethylpyrrolidines **127** with selected electrophiles, under careful control of the reaction conditions.⁵²

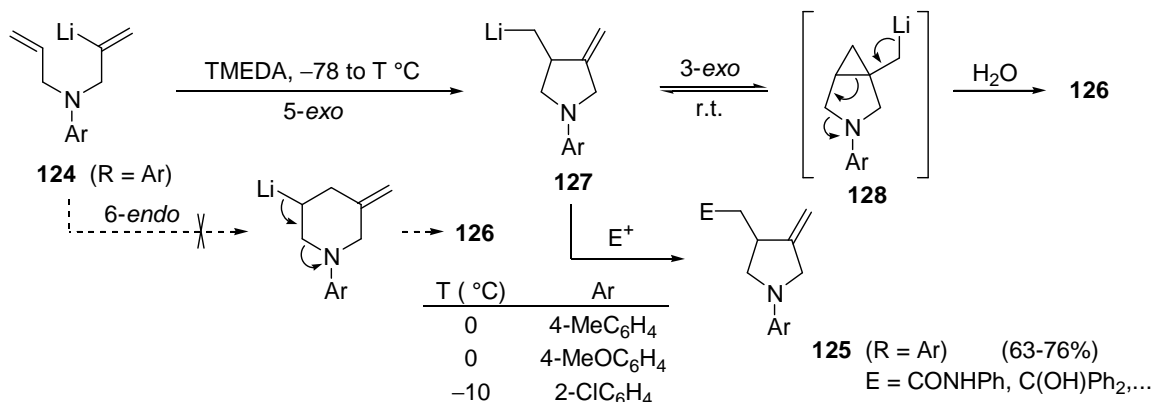

Scheme 36

Taking advantage of the fact that 1,2-disubstituted olefins in which the initially formed alkyllithium product is substituted with a moderately activating group are able to undergo intramolecular carbolithiation,^{23a} we have synthesized *N*-(3-functionalized-2-propenyl)-*N*-(2-bromoallyl)amines **129** by selective functionalization of secondary *N*-allyl amines⁵³ and further alkylation with 2,3-dibromopropene (Scheme 37). Their treatment with *t*-BuLi and TMEDA at low temperature and further warming up led to a new cyclic organolithium, which is trapped with different electrophiles allowing the isolation of pyrrolidine derivatives **130** with two functional groups at the C-3 substituent. When the E and G groups are different, compounds **130** are obtained as a *ca.* 2:1 mixture of diastereoisomers (Scheme 37).⁵⁴ This fact seems to indicate that although the carbolithiation reaction is assumed to be a *syn*-addition process, the resulting organolithium must be configurationally labile at the temperature required to achieve the cyclization. We also found that the presence of G groups on the double bond, such as trimethylsilyl or phenylthio, allows the cyclization to take place at lower temperatures.

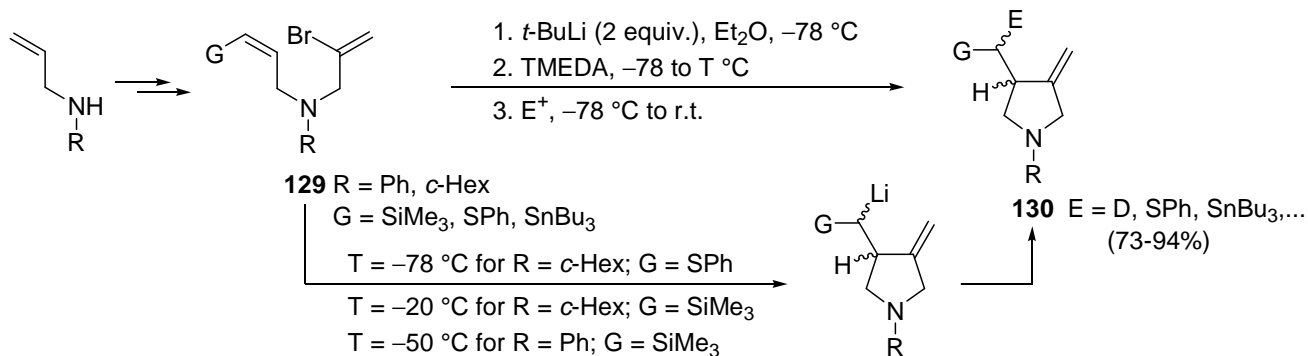

Scheme 37

Although a major drawback of the intramolecular carbolithiation reactions is that they are limited to terminal double bonds or to 1,2-disubstituted alkenes in which the initially formed alkyllithium is substituted

with a leaving group in a β -position (see Scheme 33) or is stabilized by a moderately activating group (see Scheme 37), our group has discovered that lithiated double bonds are also able to undergo a carbolithiation process. We described that *N,N*-bis(2-lithioallyl)amines **131**, generated by a double bromine-lithium exchange, easily cycloisomerize upon addition of TMEDA to afford 3,4-bis(lithiomethyl)dihydropyrroles **132**, which could be trapped with electrophiles leading to 3,4-difunctionalized-3-pyrroline derivatives **134** (Scheme 38).⁵⁵ The reaction could take place by assuming an intramolecular carbolithiation of one vinyl lithium moiety by the other one, affording dilithiated methylenepyrrolidines **133**, which undergo an allylic rearrangement to give dilithiated compounds **132**. The synthetic scope of this new reaction was extended by treatment of dianions **132** with several electrophiles, including the formation of a new class of metallacyclopenta[3,4-*c*]pyrrole derivatives **135**. In addition, the subsequent oxidation of aromatic amine-derived dihydropyrroles **134** and **135** ($R=Ar$) with DDQ afforded the corresponding pyrrole derivatives **136** and **137**, which present a pattern of substitution difficult to achieve by conventional routes (Scheme 38).⁵⁶

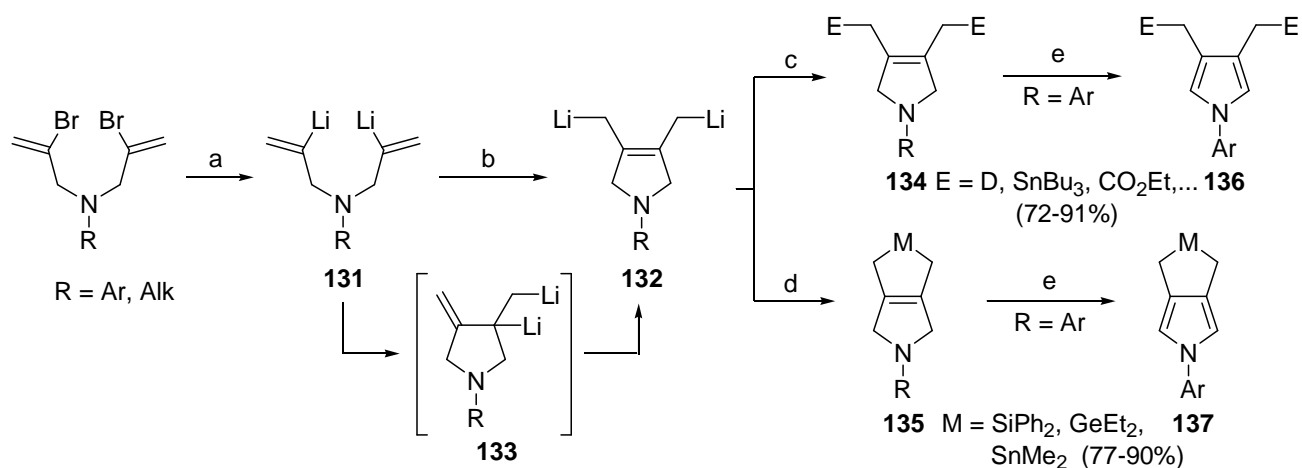

(a) *t*-BuLi (4 equiv.), Et₂O, -78 °C; (b) TMEDA, -78 °C to r.t.; (c) E⁺, -78 °C to r.t.; (d) MCl₂, -78 °C to r.t.; (e) O₂ (1 atm.) or DDQ (1 equiv.), dioxane, r.t.

Scheme 38

Interestingly, treatment of dianion **132a** ($R=Ph$) with bromobenzene gave rise, after quenching the mixture with different electrophiles, to the dihydropyrrole dimers **138**. The outcome of the reaction could be explained by a halogen-lithium exchange that produces a monoanion, which upon δ -elimination affords the exocyclic diene **139**. Further carbolithiation of **139** by **132a**, probably favored by TMEDA, would produce a dilithiated dimer, which by reaction with electrophiles leads to compounds **138** (Scheme 39).⁵⁶

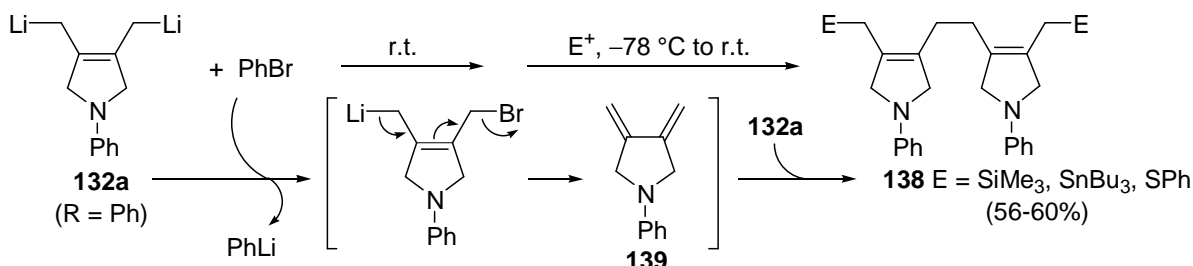

Scheme 39

We have also described other new and unexpected reactivity of dianions **132** with carboxylic esters. 3-Pyrrolylacetone derivatives **140** or hydroxycyclopenta[*c*]pyrrole derivatives **141** could be selectively

obtained depending on the reaction conditions (Scheme 40). Initial attack of **132b** on the ester carbonyl group would yield a monoanion, which could be quenched at low temperature to afford **140** after oxidation. On the other hand its closure to the bicyclic alkoxide that releases **141** after hydrolysis and further oxidation, took place at room temperature. With this methodology, it was possible to form up to three new C–C bonds selectively in a “one-pot” process, to afford a functionalized pyrrole derivative such as **142**, also showing that a lithium enolate should be formed upon addition of THF to the reaction mixture.⁵⁷ On the other hand, although dibromide **143** could not be obtained by treatment of **132b** with halogen-based electrophiles (a diene like **139** is obtained in this case), it could be prepared by a three-step sequence (trapping of **132b** with a borate, oxidation to the diol and treatment with HBr). With dibromide **143** in hand, we were able to prepare interesting bicyclic or tricyclic dihydropyrrole derivatives **144** and **145** (Scheme 40).⁵⁷

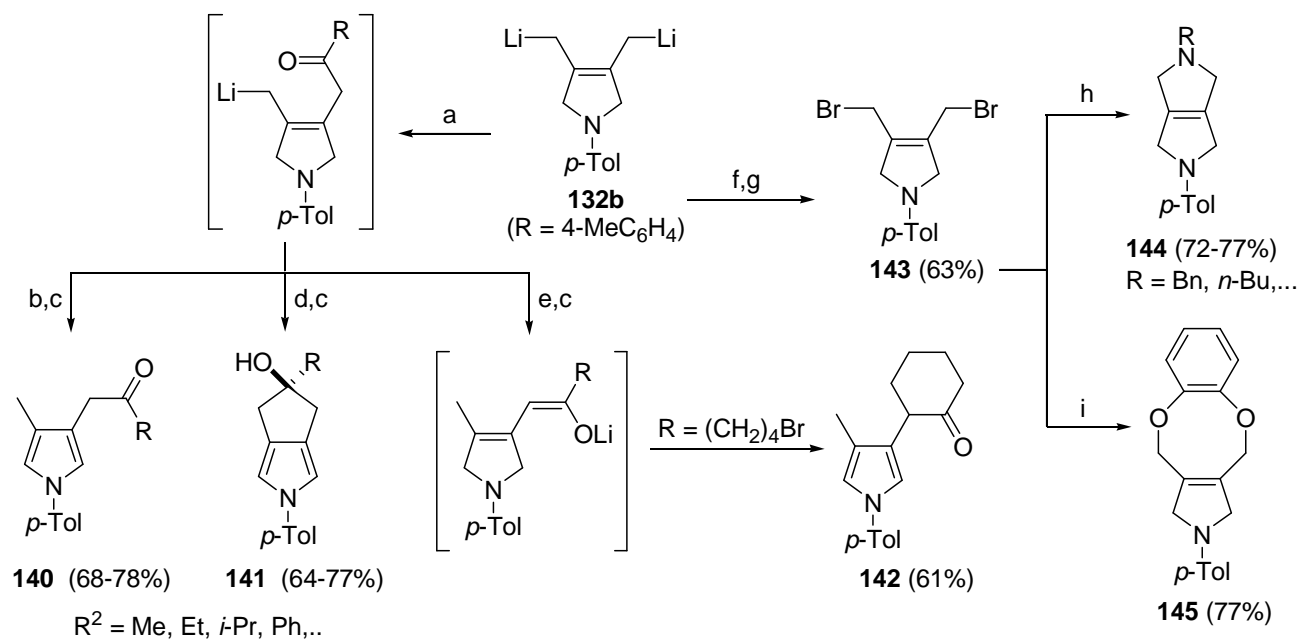

(a) RCO₂Et (1 equiv.), Et₂O, -78 °C; (b) MeOH, -78 °C to r.t.; (c) DDQ (1 equiv.) or air, CH₂Cl₂; (d) Et₂O, -78 °C to r.t.; (e) THF, -78 °C to r.t.; (f) 1. B(OMe)₃ (2 equiv.), Et₂O, -78 °C to r.t.; 2. NaOH/H₂O₂ (4 equiv.), 0 °C to reflux; (g) HBr conc.; (h) RNH₂ (1 equiv.), K₂CO₃ (2 equiv.), MeCN, reflux; (i) catechol (1 equiv.), K₂CO₃ (2 equiv.), Me₂CO, reflux.

Scheme 40

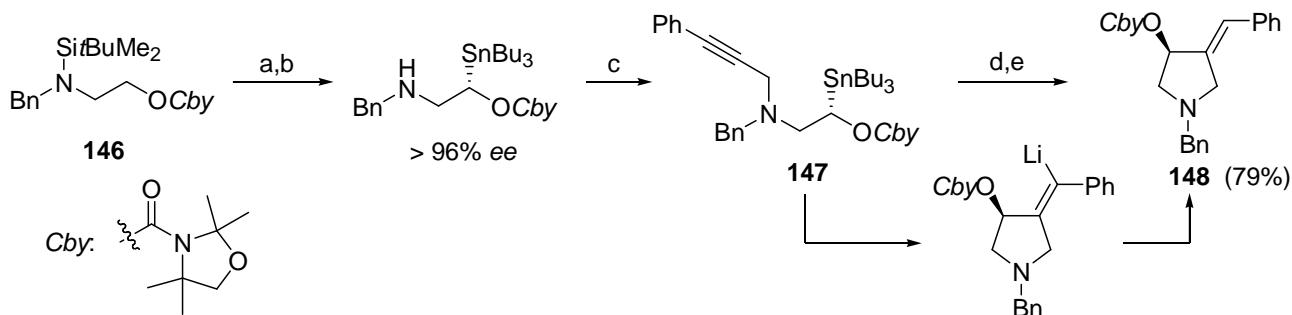

(a) *s*-BuLi (1.4 equiv.), THF, (-)-sparteine (1.5 equiv.), -78 °C; (b) Bu₃SnCl, -78 °C to r.t., 86% from **146**;
 (c) Na₂CO₃, MeCN, ClCH₂C≡CPh, 95%; (d) BuLi (1.5 equiv.), Et₂O, -78 °C; (e) MeOH, -78 °C to r.t.

Scheme 41

Enantiomerically enriched *O*-Cby-protected 3-benzylidene-4-hydroxypyrrolidine **148** was obtained as a single diastereoisomer by treatment of enantioenriched stannane **147** with BuLi and subsequent 5-*exo*-dig

intramolecular carbolithiation of the intermediate α -lithio carbamate. The precursor **147** was formed by stereoselective deprotonation of a *N*-silyl-protected β -aminoalkyl carbamate **146**. The (*E*)-configuration of the exocyclic double bond in the final pyrrolidine **148** is the result of a *syn* addition onto the triple bond (Scheme 41).⁵⁸ Although the *ee* of **148** could not be determined, it is expected that this product would have been generated with high enantioselectivity by comparison with similar procedures.

3.5. Synthesis of azabicyclo derivatives

In this section, reactions that will be described are those in which the heterocyclic ring exists prior to the carbolithiation process takes place. So, azabicyclic or azaspirocyclic compounds are generated in a high selective manner. The first report of a carbolithiation reaction onto alkenes in which the carbanion is generated at a chiral centre in enantiomerically pure form is also due to Coldham and co-workers. The anionic cyclization of enantiomerically pure stannane **149** gave a single diastereoisomer **150**, as expected from related carbolithiation reactions with the preference for reaction *via* a chair-like conformation (Scheme 42).⁵⁹ Moreover, the cyclization reaction took place with retention of configuration at the lithium atom bearing carbanion centre and without loss of *ee*, showing that the carbolithiation reaction to the five-membered ring is more rapid than racemization. In this way, (+)-*pseudoheliotridane* **150a** and several pyrrolizidine derivatives **150b–e** have been prepared (Scheme 42).⁵⁹ This strategy represents an example of the “chiral substrate” approach for the control of absolute stereoselectivity in the intramolecular carbolithiation reactions.

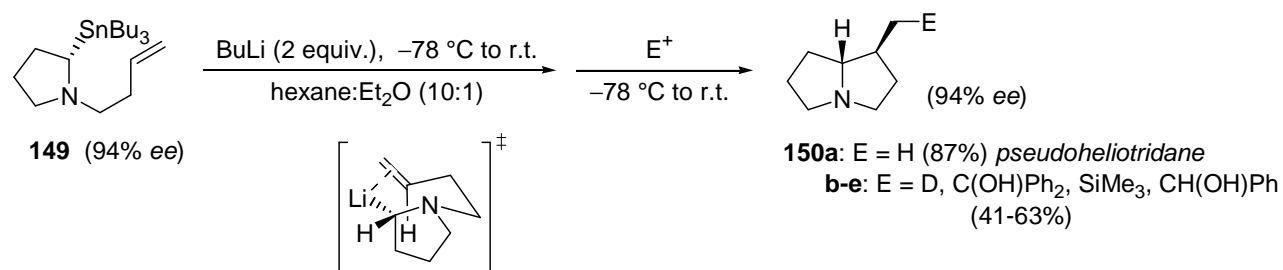

Scheme 42

The chemistry outlined in Scheme 32 was also extended to the preparation of substituted pyrrolizidines **152** from *N*-(tributylstannyl)methyl-2-allylpyrrolidine **151** (Scheme 43).^{48b} The functionalized pyrrolizidines **152** were isolated as their picrate salts, as an inseparable mixture (3:1) of diastereoisomers. The preference for a chair-shaped transition state, with a *cis*-fused azabicyclo[3.3.0]octane ring system, suggests that the major diastereoisomer would be the first.

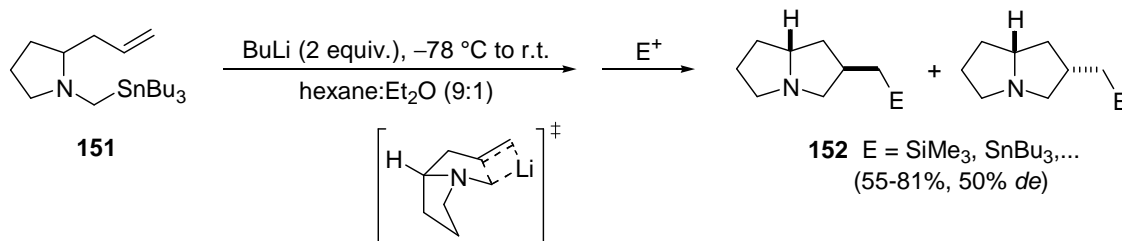

Scheme 43

Hoppe and co-workers have described a stereoselective synthesis of hydroxylated indolizidines establishing up to four stereogenic centres. The key steps are a kinetic resolution and a stereospecific and intramolecular carbolithiation reaction starting from readily available racemic carbamate **153** under the action of (–)-sparteine. Asymmetric deprotonation of **153** results in a “matched” [(*R*)-**153**-Li] and “mismatched” [(*S*)-**153**-Li] pair of organolithiums, that are kinetically resolved into indolizidine **154** and recovered (*S*)-**153** (Scheme 44).⁶⁰ Further functionalization of the side chain with generation of one more stereogenic centre was also possible by trapping the benzylic anion with electrophiles. Indolizidines **155** are obtained as variable mixtures of diastereoisomers due to the fact that the interconversion of the intermediate epimeric ion pairs proceeds with a rate comparable to the rate of the substitution step (Scheme 44).⁶⁰

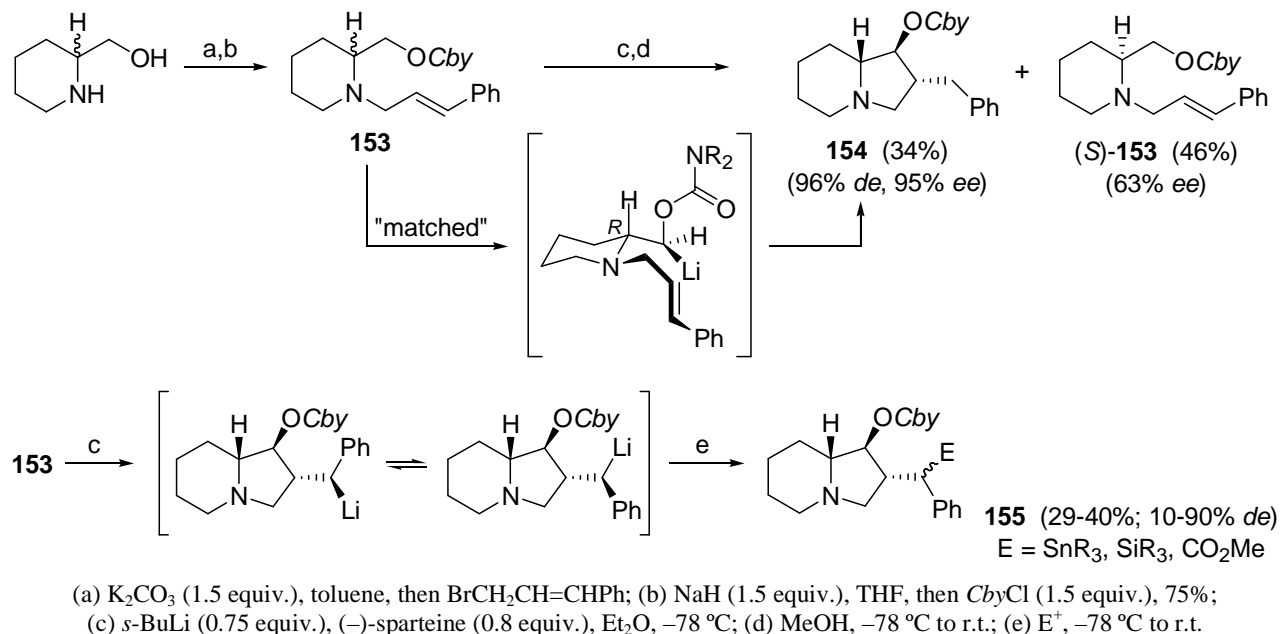

Scheme 44

Tin-lithium exchange and intramolecular carbolithiation have been used by Coldham and co-workers to construct the three nitrogen-positional isomers of the azabicyclic[2.2.1]heptane ring system. Deprotonation of *N*-Boc-2-allylpyrrolidine and treatment with Bu_3SnCl gave an equal mixture of the two diastereomeric pyrrolidines **156**. Conversion of the *N*-Boc group to a *N*-benzyl group was carried out by a two-step procedure (Scheme 45).

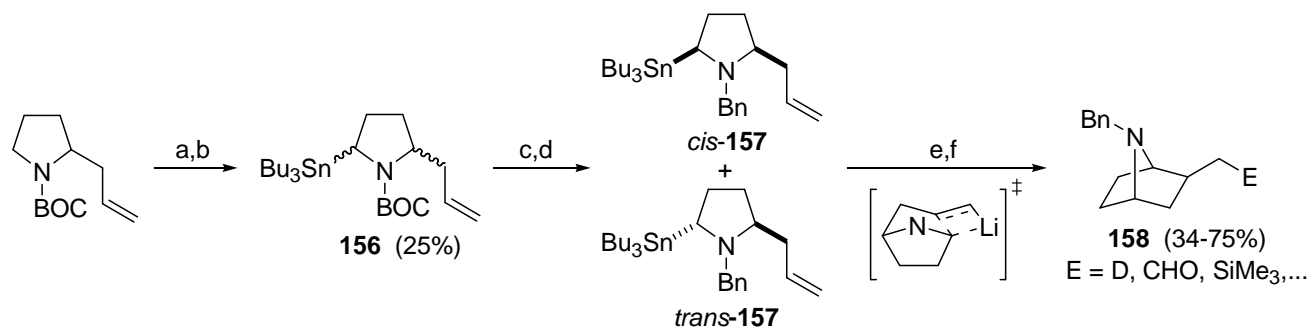

(a) *s*-BuLi, (–)-sparteine, Et_2O , -78°C ; (b) Bu_3SnCl ; (c) *B*-bromocatechol borane, CH_2Cl_2 , then NaOH , PhCOCl , 80%; (d) AlH_3 , Et_2O , 79% for *cis*-**157** and 71% for *trans*-**157**; (e) BuLi (4 equiv.), -78°C to r.t., hexane: Et_2O :THF (4:1:1); (f) E^+ , -78°C to r.t.

Scheme 45

Both diastereomers of **157** afforded 2-substituted 7-azabicyclo[2.2.1]heptanes derivatives **158** with complete stereochemical control in favor of the *exo* diastereoisomer. The transition state from **157** would favor the normal chair shape, as this places the alkene unit closer to the lithium atom coordinated to the nitrogen lone pair (Scheme 45).⁶¹

For the synthesis of the 2-azabicyclo[2.2.1]heptane ring, two disconnections are possible. In the first of them, stannane precursor **160** was easily generated from the known β -amino ester **159** (Scheme 46). Upon transmetalation with BuLi, **160** gave rise to a mixture of the desired 2-azabicyclo[2.2.1]heptane **161** and *cis*-2-vinyl-4-methylpyrrolidine **162** derived from monocyclization. Pleasantly, better yields of **161** could be obtained using a second approach from 2,4-disubstituted pyrrolidine **164**, which was obtained from stannane **163**. In spite of the *trans*-arrangement of the tin (and, hence, lithium) and the allyl moiety, the cyclization proceeds in reasonable yield probably due to epimerization of the intermediate organolithium (Scheme 46).^{61b} Surprisingly, the anionic cyclization of **164** also affords the *endo*-isomer of **161** suggesting that, in this case, a boat-shaped transition state is favored, probably due to coordination of the lithium atom to the nitrogen lone pair (Scheme 46).^{61b}

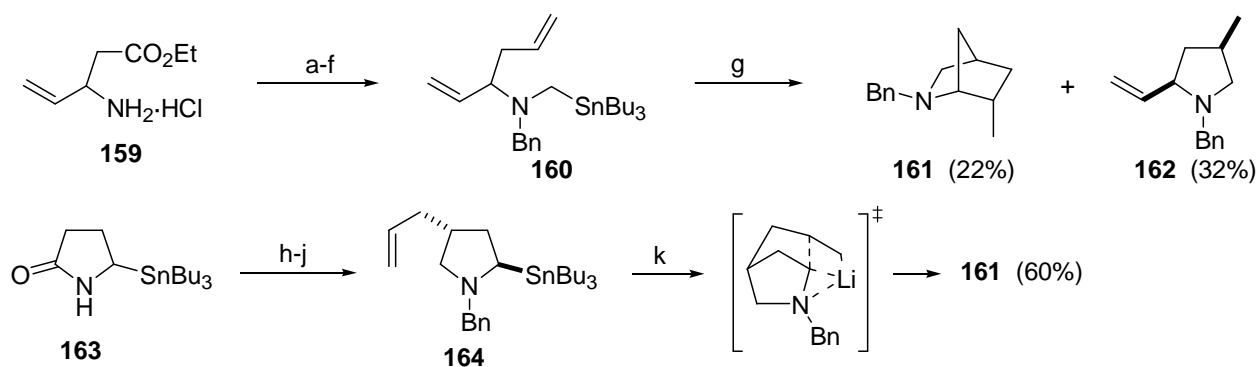

- (a) PhCOCl, Et₃N, Et₂O, 75%; (b) LiAlH₄, THF, 0 °C, 81%; (c) (COCl)₂, DMSO, CH₂Cl₂, -78 °C, then Et₃N, 79%; (d) Ph₃PMeBr, *t*-BuOK, THF, 46%; (e) NaH, ICH₂SnBu₃, THF, r.t., 73%; (f) AlH₃, Et₂O, -78 °C to r.t., 88%; (g) BuLi (3 equiv.), -78 °C to r.t., hexane:Et₂O:THF (4:1:1), then MeOH, -78 °C to r.t.; (h) NaH, DMF, BnBr, 72%; (i) LDA, THF:HMPA, CH₂=CHCH₂Br, 51%; (j) AlH₃, Et₂O, 0 °C, 72%; (k) BuLi (5 equiv.), r.t., hexane:Et₂O (4:1), then MeOH, r.t.

Scheme 46

In the same context, the 1-azabicyclo[2.2.1]heptane **166**, isolated as its picrate salt, was conveniently accessed from piperidinyl stannane **165**, which was synthesized from commercially available hydrochloride salt of 4-piperidone monohydrate. In this case, the addition of TMEDA is necessary to promote the cyclization (Scheme 47).^{61b}

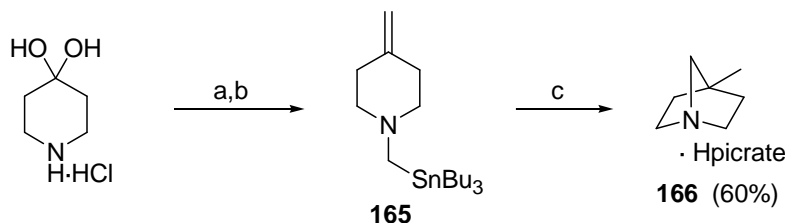

- (a) MsOCH₂SnBu₃, MeCN, K₂CO₃, r.t., 64%; (b) Ph₃PMeBr, BuLi, THF, r.t., 95%; (c) BuLi (2 equiv.), hexane:Et₂O (9:1), then TMEDA (2 equiv.), -78 °C to r.t., then MeOH, -78 °C to r.t., then picric acid.

Scheme 47

Whereas, as shown in Scheme 42, the use of a stereochemically defined and configurationally stable α -amino-organolithium allows that the 5-*exo* carbolithiation reaction took place with complete stereocontrol, the corresponding 6-*exo* carbolithiation of the organolithium derived from stannane **167a** was complicated by competitive racemization prior to the slow cyclization step. In order to improve the optical purity of the indolizidine products, stannane **167b**, bearing an alkene moiety substituted with an anion stabilizing group, was tested (Scheme 48). In this case, octahydroindolizidines **168** and **169** were obtained with good *ee*, probably due to an increase of the rate of the anionic cyclization reactions.⁶² However, using the solvent system hexane:Et₂O:TMEDA (4:1:1), racemic **169** was exclusively formed in good yield. The presence of a phenylthio group at the terminus of the ally unit in stannane **170** also promoted a 4-*exo-trig* carbolithiation reaction. A moderate yield of the desired 1-azabicyclo[3.2.0]heptane derivatives **171** and **172** was obtained, with a high diastereoselectivity in favor of the isomer **171**. The high *ee* found in the major isomer must reflect a cyclization that is much more rapid than epimerization of the intermediate organolithium species in hexane:Et₂O (Scheme 48). Again, the cyclization of **170** was sensitive to the solvent and the presence of TMEDA afforded similar diastereoselectivity but reduced enantioselectivity.⁶²

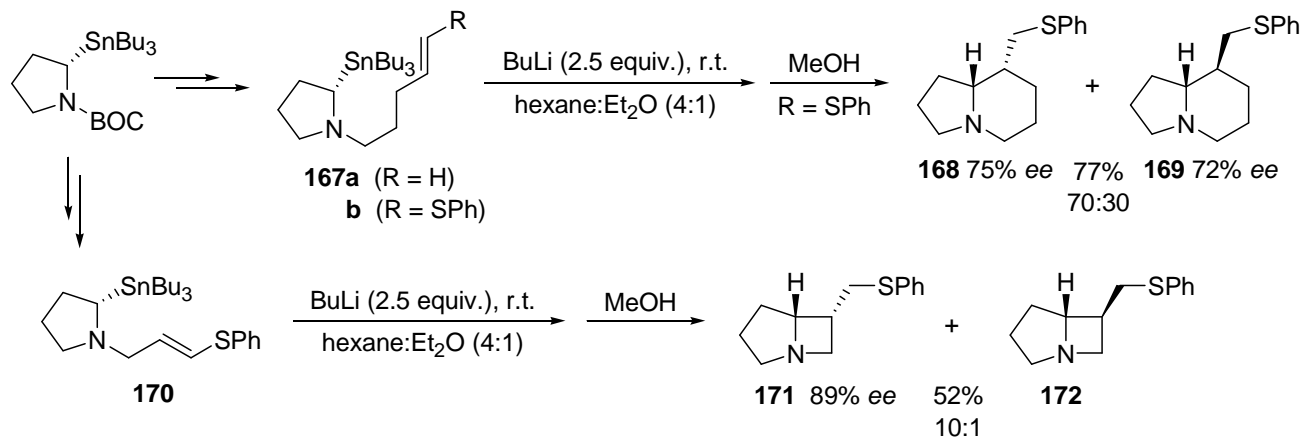

More recently, Tomioka and co-workers have demonstrated that the double cyclization of allylaminoalkenes **173**, through a tandem aminolithiation–carbolithiation sequence, provides an easy access to bicyclic octahydroindolizidine **174** and hexahydro-1*H*-pyrrolizidine **175** skeletons (Scheme 49).⁶³

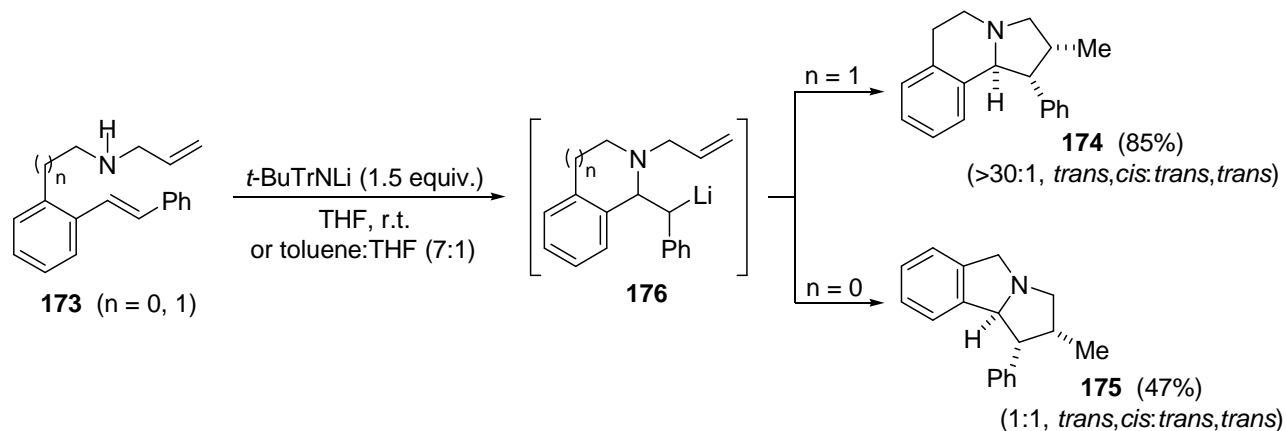

The consideration of competitive steps between protonation and carbolithiation of intermediate **176** led the authors to a screening of amine as a proton source and so, the bulky *t*-butyltritylamine was found as the optimum lithium amide to promote this tandem process (Scheme 49). A chair-like conformation for the transition states accounts for the preferential production of *trans,cis*-isomers, although the involvement of lithiophilic THF, could allow the formation of the *trans,trans*-isomer.

Rychnovsky and co-workers have recently reported that *tert*- α -amino alkyl lithium reagents **177** can be prepared by reductive lithiation of α -amino nitriles **176** and that these organolithiums can undergo intramolecular carbolithiation reactions with an appropriate unsaturated tethered moiety (Scheme 50).⁶⁴ These cyclization reactions are highly stereoselective leading to [4.4] and [4.5] spirocyclic structures **178** and **179**. The observed diastereoselectivity was rationalized by invoking coordination between the equatorial lone pair of the nitrogen atom and the lithium atom in the transition state (Scheme 50). The alkyl lithium cyclization was also effective with alkynyl piperidine **180** and selective *cis*-carbolithiation onto the TBS-alkyne produced the *E*-alkene **181** in modest yield (Scheme 50).⁶⁴

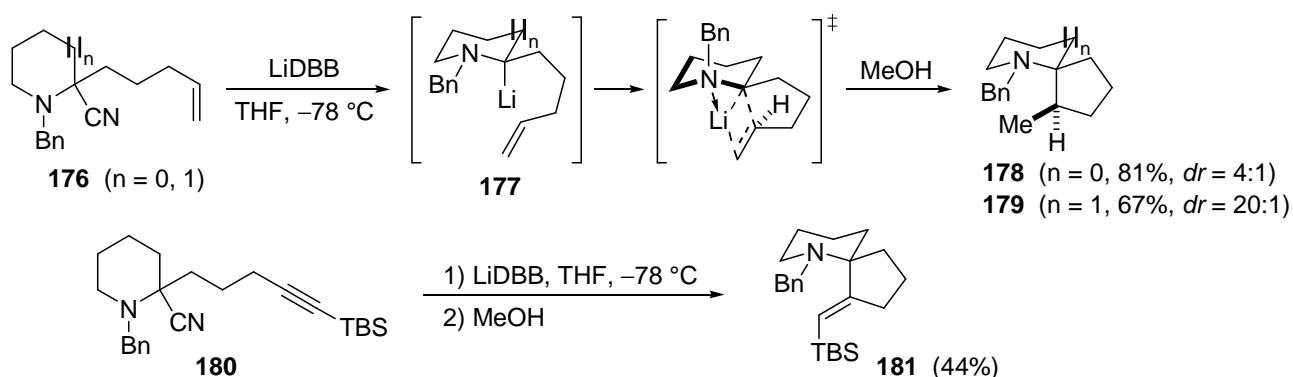

Scheme 50

3.6. Synthesis of indole derivatives

In 1996, Liebeskind and Zhang⁶⁵ as well as Bailey and Jiang,⁶⁶ simultaneously reported that aryllithiums **183**, derived from *N,N*-diallyl-2-bromoanilines **182**, cyclized upon warming to 0 °C in the presence of TMEDA to give a (1-allyl-3-lithiomethyl)indole derivatives **184** that may be trapped with a variety of electrophiles to deliver 3-functionalized 1-allyl-indolines **185** in good yields (Scheme 51). Later on, Bailey and co-workers observed that the dilithio species, derived from *N*-allyl-2-bromoaniline **186** upon treatment with *t*-BuLi at low temperature, cyclized after addition of TMEDA and warming to give 1-lithio-3-lithiomethylindole **187**. This dianion may be differentially functionalized by sequential addition of electrophiles affording 1,3-disubstituted indolines **188** (Scheme 51).⁶⁷ A similar strategy was used in the synthesis of BOC protected benzo[*f*]tryptophan **190**, employing naphthalene derivative **189** as starting material (Scheme 51).⁶⁸

By a similar strategy, all four isomeric pyrrolopyridine derivatives, with a methyl substituent at C-3, have been prepared *via* intramolecular carbolithiation of the aryllithium derived from an appropriate (*N,N*-diallylamino)-bromopyridine **191** (Scheme 52).⁶⁹ Whereas ring-closure to give 1-allyl-3-methyl-2,3-dihydro-1*H*-pyrrolo[3,2-*b*]pyridine **192** and 1-allyl-3-methyl-2,3-dihydro-1*H*-pyrrolo[2,3-*c*]pyridine **193** proceeds in the normal way, the corresponding isomeric 3-methyl-5-azaindolines and 3-methyl-7-azaindolines are generated as 3-methyl-*N*-allyl anions **198** prior to quench with MeOH. Thus, along with the

expected 1-allyl-3-methyl-2,3-dihydro-1*H*-pyrrolo[3,2-*c*]pyridine **194** and 1-allyl-3-methyl-2,3-dihydro-1*H*-pyrrolo[2,3-*b*]pyridine **195**, the enamine-type products **196** and **197** are obtained as major products in these cases (Scheme 52).⁶⁹ A partial positive character of the N(1) position in a 5- or 7-azaindoline may be invoked to account for the deprotonation of the *N*-allyl group in these substrates.

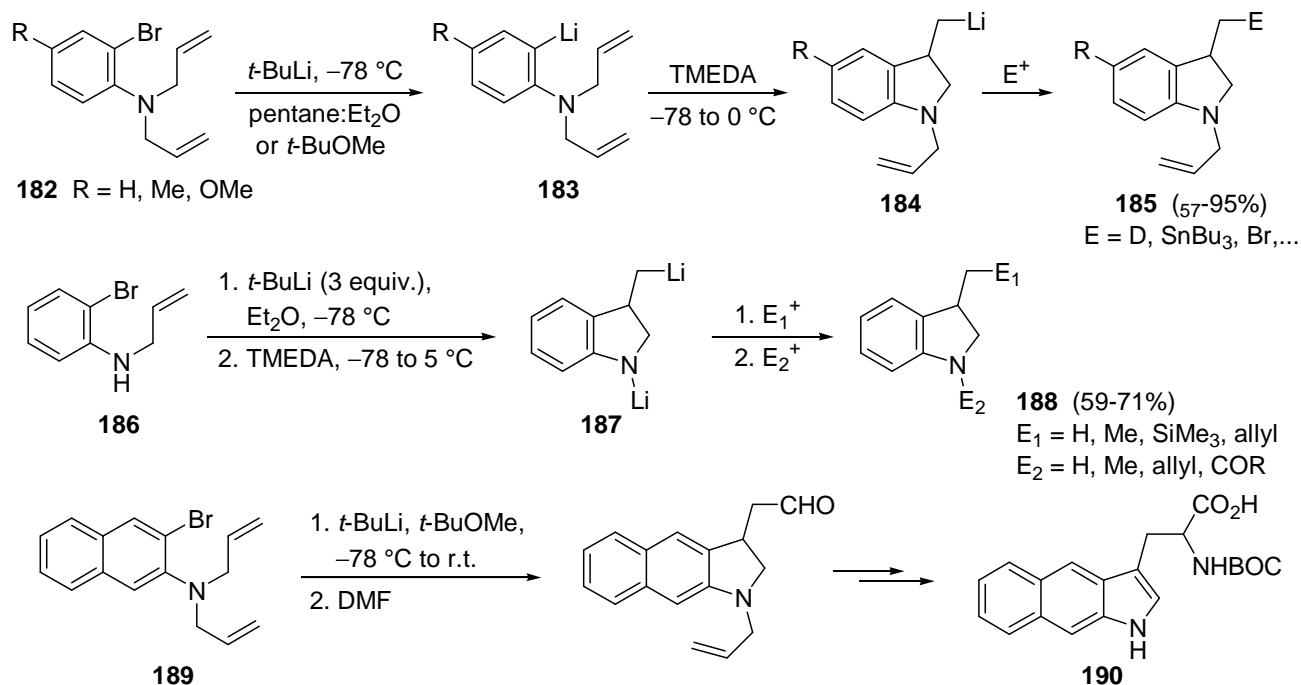

Scheme 51

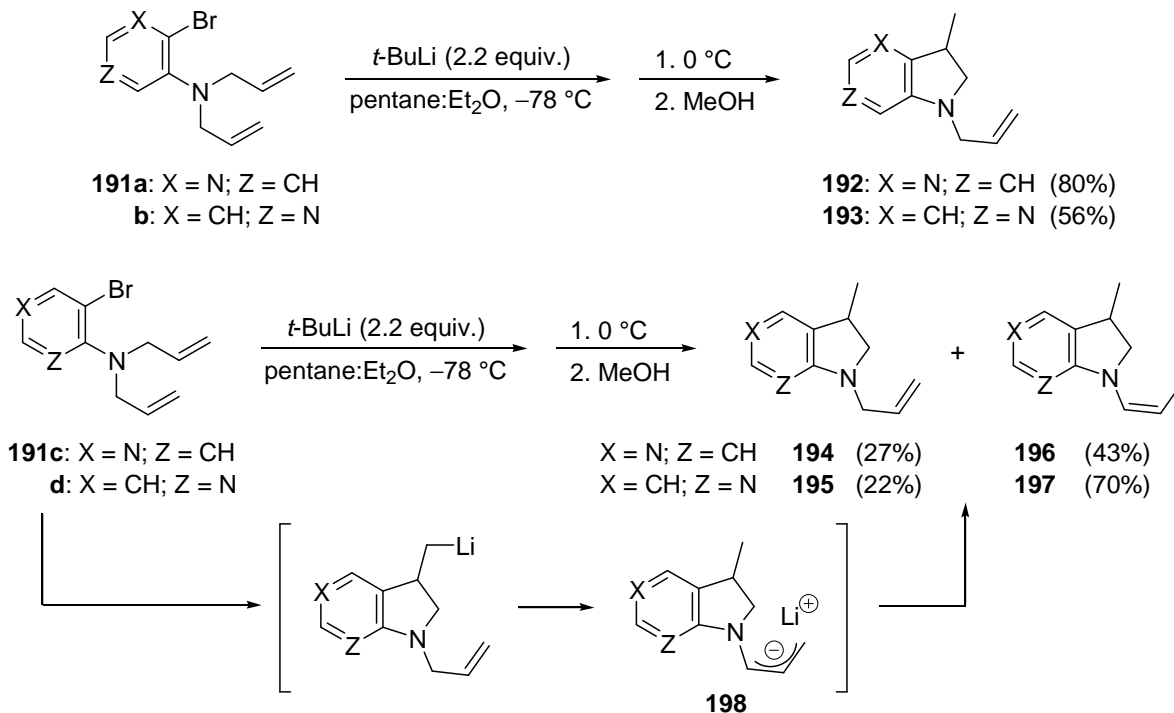

Scheme 52

The ability to discriminate between the enantiotopic faces of an unactivated carbon-carbon double bond tethered to a lithium-bearing carbon centre by the use of an external ligand like (–)-sparteine,

considerable extends the synthetic utility of intramolecular carbolithiation reactions. Bailey and Mealy⁷⁰ as well as Groth and Sanz⁷¹ independently reported the enantioselective version of the methodology described in Scheme 51. When the carbolithiation reactions of organolithiums **199**, generated by bromine-lithium exchange, were carried out in the presence of (–)-sparteine, the indolines **200** were obtained enantiomerically enriched. Best results were observed by conducting the reactions in non-polar solvents. In pentane:Et₂O, **199a** (R¹=allyl; R²=H) gave rise to **200a** in 69% yield and 86% *ee* (Scheme 53).⁷⁰ However, replacement of one of the *N*-allyl groups with a methyl group results in a lower *ee* of the 1,3-dimethylindoline **200b**. On the other hand, with *N*-benzylaryllithium derivatives **199c,d** as starting materials up to 90% *ee* was obtained by using toluene as solvent (Scheme 53).⁷¹ Later on, Bailey and co-workers studied the effect of the chiral ligand structure on the enantioselective carbolithiation of **199a**. Although none of the tested ligands was shown to be superior to (–)-sparteine, the pseudoephedrine derivative **201**, which is also available in either enantiomeric form, approached the efficiency of sparteine.⁷² Moreover, this ligand was successful for the enantioselective carbolithiation of dianion **187**, whereas (–)-sparteine was not able to promote any cyclization (Scheme 53).⁶⁷ However, the ability of a chiral ligand to facilitate the cyclization of an achiral, unsaturated organolithium is not sufficient to render the cyclization enantioselective.⁷⁰ In fact, complexation of a ligand with the lithium atom of a substrate may hinder the cyclization, as it has been shown for **199e** with a methyl group at the 3-position (Scheme 53).⁷² In this case, the corresponding indoline **200e** is obtained in low yield and enantioselectivity in the presence of (–)-sparteine, whereas in the absence of any diamine ligand a 94% yield of racemic **200e** was isolated.⁷²

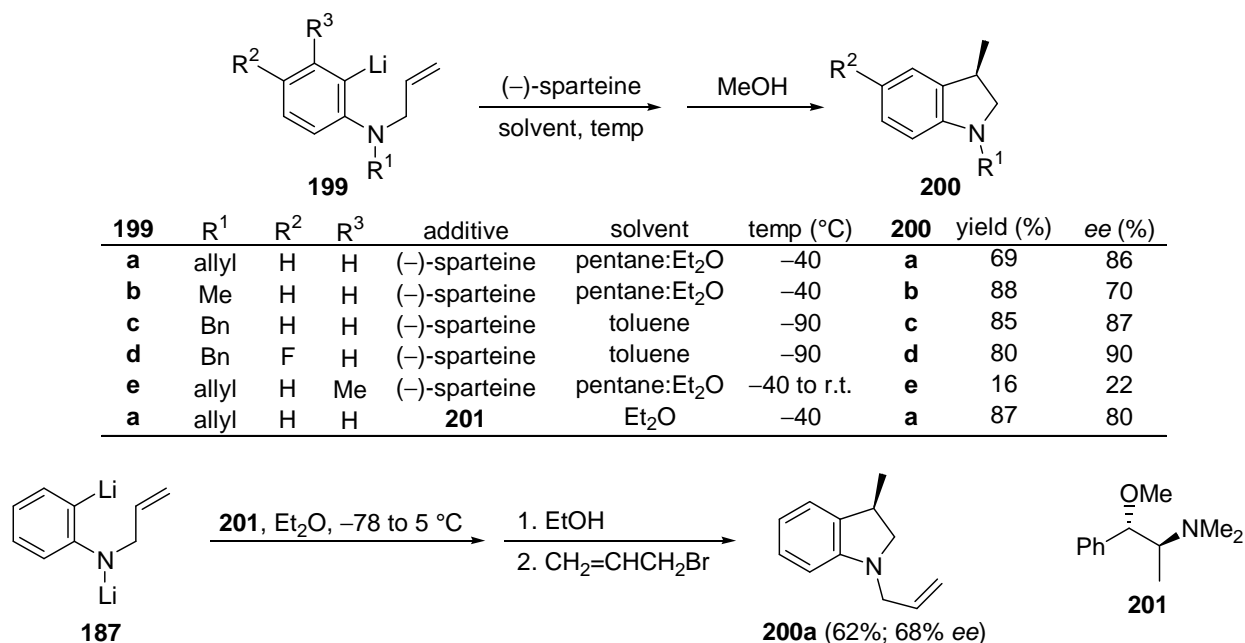

Scheme 53

In this way, Groth and co-workers have prepared functionalized 3,3-disubstituted indolines **203** via a (–)-sparteine-mediated asymmetric intramolecular carbolithiation of *N*-benzyl protected 2-bromoanilines **202** (Scheme 54).⁷³ They studied the effect of different substituents at the internal position of the double bond to be carbolithiated on the efficiency and the enantiomeric excess of the cyclization reactions. These authors have also applied this methodology to the synthesis of a known compound **206**, which is an

intermediate towards the synthesis of *physostigmin*. The cyclization precursor **204**, readily available from *p*-anisidine, was treated with *t*-BuLi in the presence of (–)-sparteine and the resulting cyclized organolithium intermediate was trapped with DMF affording indoline **205**. Further conventional transformations gave rise to product **206**, which revealed the *R*-configuration of **205** (Scheme 54).⁷³

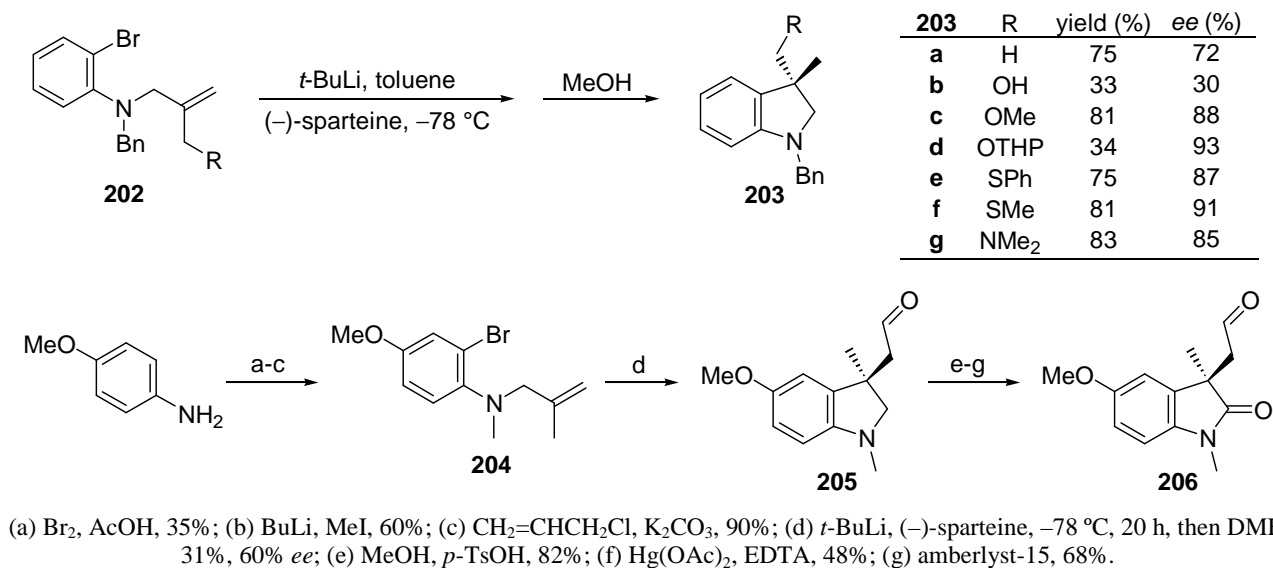

Scheme 54

According to the strategy shown in Scheme 37, we have reported the diastereoselective formation of hexahydroindole derivatives **208** from the *N*-(2-bromo-cyclohex-2-enyl)amine derivative **207**. Bromine-lithium exchange followed by addition of TMEDA and warming to –60 °C afforded the heterocycles **208** through a four-centre transition state. A preferred coplanar approach of the C–Li bond to the double bond would give rise to the observed stereoselectivity (Scheme 55).⁵⁴

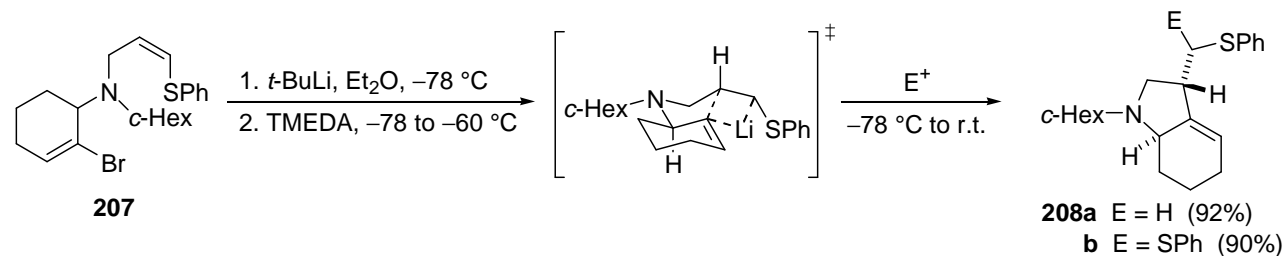

Scheme 55

In the context of studying the scope of the new carbolithiation reaction of lithiated double bonds (see Schemes 38–40), we prepared 2-bromo-*N*-(2-bromoallyl)anilines **209** and treated them under the reported conditions, *i.e.* *t*-BuLi for bromine-lithium exchange and further addition of TMEDA. In this case, we found that 3-functionalized indoles **211** were isolated after quenching with selected electrophiles. The formation of the indole nucleus could be explained through a carbolithiation of the vinyl lithium moiety by the aryllithium in the dianions **210** to afford dilithiated indoline derivatives (Scheme 56). As an allylic rearrangement would involve the loss of aromaticity, elimination of lithium hydride takes place affording 3-lithiomethylindole intermediates **212**. Moreover, when **209a** was treated with five equiv. of *t*-BuLi, a new dilithiated indole derivative **213** was generated, which could be trapped with 1,2-diketones giving rise to cyclopenta[*b*]indole

derivatives **214** (Scheme 56). In addition, *N*-unsubstituted indoles **211** (R=H) could also be prepared in moderate yields starting from secondary amine **209c** by using five equiv. of *t*-BuLi (Scheme 56).^{55,56}

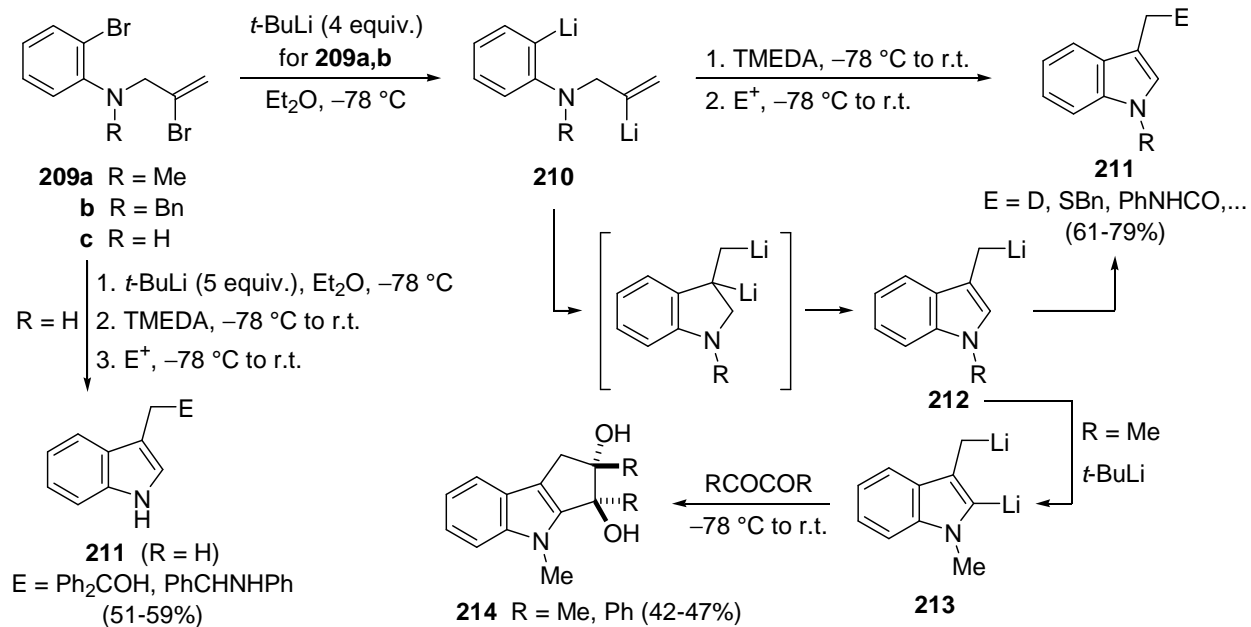

Scheme 56

In the same way, the tetrahydroindole derivative **216** was synthesized from amine **215** by its treatment with *t*-BuLi / TMEDA, hydrolysis and further oxidation (Scheme 57).⁵⁶

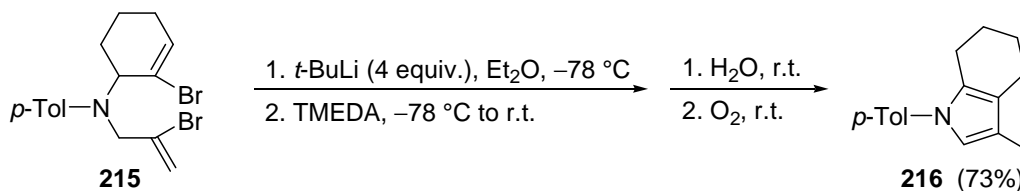

Scheme 57

Maddaluno and Le Strat tried to apply a similar sequence as described in Scheme 30 to the construction of the indolic skeleton. In this case, iodine-lithium exchange on propargylic acetal derivative **217** afforded a complex mixture of compounds (Scheme 58).

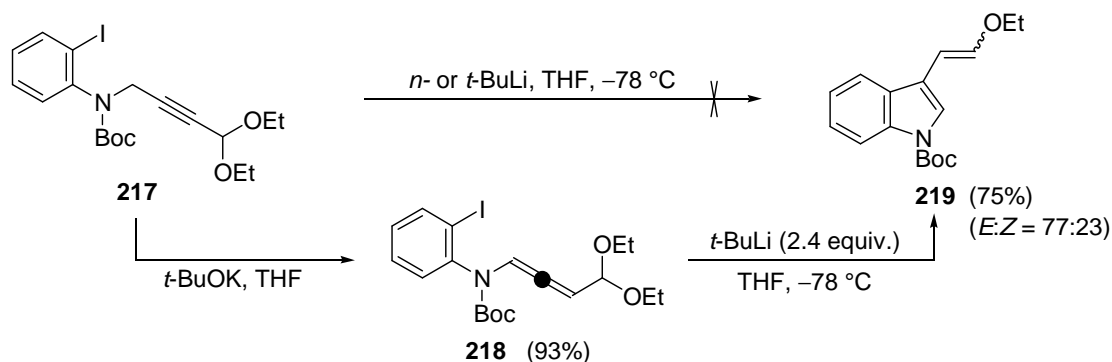

Scheme 58

However, by first isomerizing the triple bond into allene **218**, the desired ring-closure could be effected upon treatment with *t*-BuLi. The indole derivative **219** was thus obtained in good yield as a mixture of *E:Z* isomers (Scheme 58).⁴⁴

3.7. Synthesis of other heterocyclic systems

According to the methodology described in Scheme 29, the treatment of 2,2,2-trifluoroethyl-2-bromophenyl thioether **220** with an excess of an alkyl- or aryllithium in ether gave, after quenching, 3-substituted benzothiophene derivatives **221**. The reaction probably takes place through intermediate **222**, which undergoes a 5-*endo-dig* ring closure (Scheme 59).⁴³

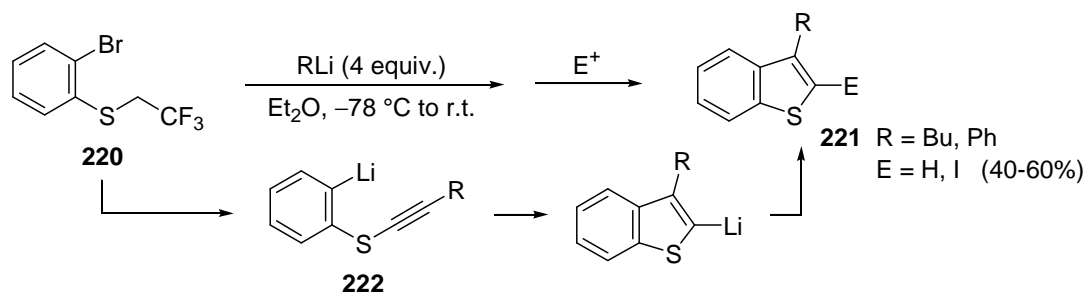

Scheme 59

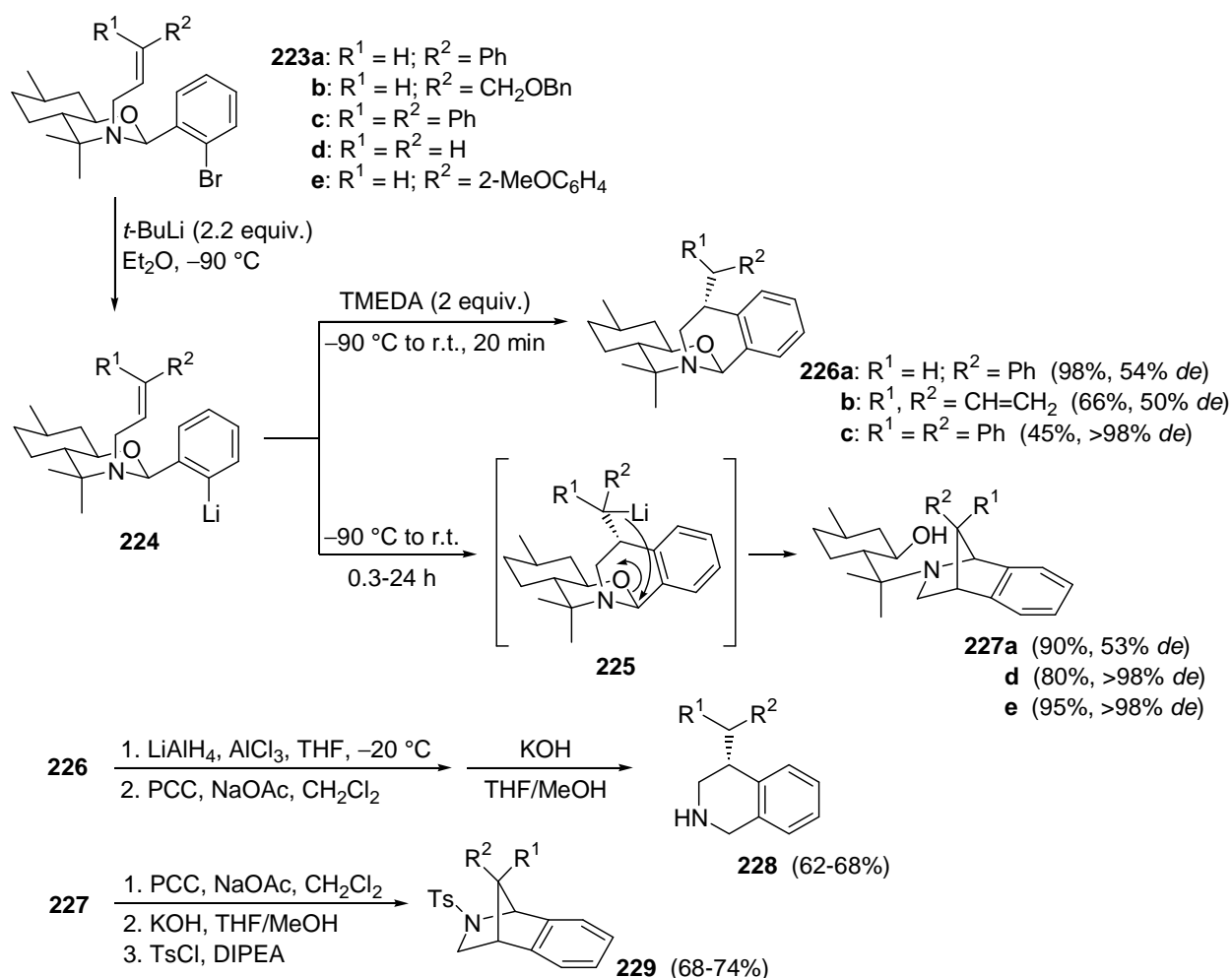

Scheme 60

Pedrosa and co-workers reported the first synthetically useful 6-*exo* carbolithiation reaction of unactivated alkenes.⁷⁴ Chiral 2-(*o*-lithiophenyl)-substituted perhydro-1,3-benzoxazines **224**, generated by bromine-lithium exchange from **223**, were used as starting materials. The anionic cyclization of **224** easily occurs in the presence of TMEDA when the resulting cyclized lithium derivative **225** is moderately stable or if it can evolve to a stable final compound by elimination of a good leaving group. In this way, cyclized products **226a–c** were diastereoselectively obtained (Scheme 60). The 6-*exo* carbolithiation reaction resulted to be also possible when the lithium intermediate **225** could undergo an intramolecular ring opening of the *N,O*-acetalic system in the absence of TMEDA, affording 2-azabenzonorbornane derivatives **227**. By further transformations, enantiopure 4-substituted tetrahydroisoquinolines **228** and enantiopure 7-substituted 2-azabenzonorbornane derivatives **229** were obtained (Scheme 60).⁷⁴

Taylor and Wei have shown that organolithium addition to homoallyl vinylsilanes **230** can be coupled with a subsequent intramolecular 5-*exo* cyclization to generate silacyclopentanes **231** in good yields and with good *trans*-selectivity (Scheme 61).⁷⁵ With homopropargyl vinylsilanes **232**, the final silacycles **233** were obtained mainly as the *Z*-isomers, probably due to the steric demand of the lithium atom in the configurationally labile vinyl anion intermediate **234** (Scheme 61).⁷⁵

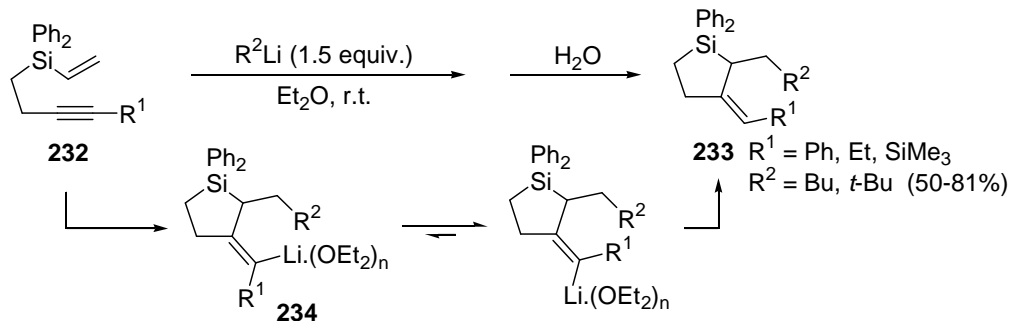
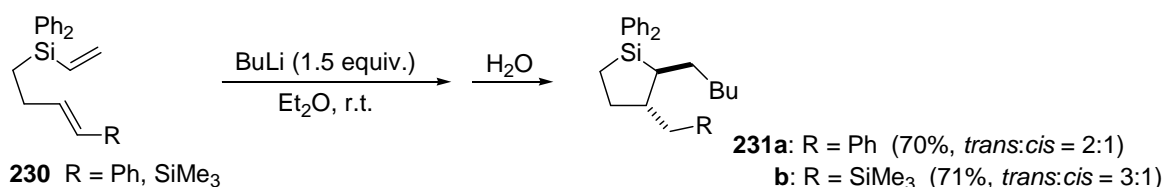

Scheme 61

3.8. Synthesis of heterocycles through carbolithiation of arynes

A direct consequence of the strained nature of the ring in arynes is that they have low lying LUMOs and so, *o*-benzyne behaves as a powerful electrophile. The formation and cyclization of aryne-tethered organolithiums remains an underexplored area and this type of cyclization could be considered as a particular case of intramolecular carbolithiation reactions, *i.e.* the addition of an organolithium across a C–C multiple bond leading to a new organolithium compound. The first examples of this strategy were reported by Bailey and co-workers involving the synthesis of 4-functionalized indanes from 1-fluoro-2-(3-iodopropyl)benzene.⁷⁶ In this field we have been interested in the anionic cyclization reactions of functionalized benzyne-tethered vinyl- and aryllithiums. Initially we studied the intramolecular 5-*exo* cyclization of benzyne-tethered vinylolithiums and simple *N*-alkyl-*N*-2-bromoallyl-2-fluoroanilines **235** resulted to be useful starting materials for the preparation of 4-functionalized indoles **236**.⁷⁷ Their treatment with *t*-BuLi initiates

a cascade reaction that probably involves (i) bromine-lithium exchange, (ii) *ortho*-lithiation to the fluorine atom, (iii) subsequent loss of lithium fluoride to deliver a benzyne intermediate **237** and (iv) intramolecular attack of the tethered vinyl lithium to the strained aryne to generate a 3-methylene-4-lithiumindoline derivative **238** (Scheme 62). Further addition of electrophiles gave rise to 4-functionalized 3-methyleneindolines **239**, which undergo aromatization to *N*-alkylindoles **236** on the workup. *N*-Unsubstituted indoles **240** were prepared by cleavage of the allyl group with DIBAL-H under nickel-catalysis. The intermediacy of 3-methyleneindolines **239** was demonstrated because these intermediates underwent Alder-ene reactions with activated enophiles, such as Eschenmosher's salt, DEAD, or diethyl ketomalonate, affording interesting 3,4-difunctionalized indoles **241** in moderate yields based on the starting amines **235** (Scheme 62).⁷⁷ Interestingly, this methodology allows the synthesis of tryptamine analogues **241** ($X-Y-H=CH_2NMe_2$) from readily available starting products in a "one-pot" procedure.

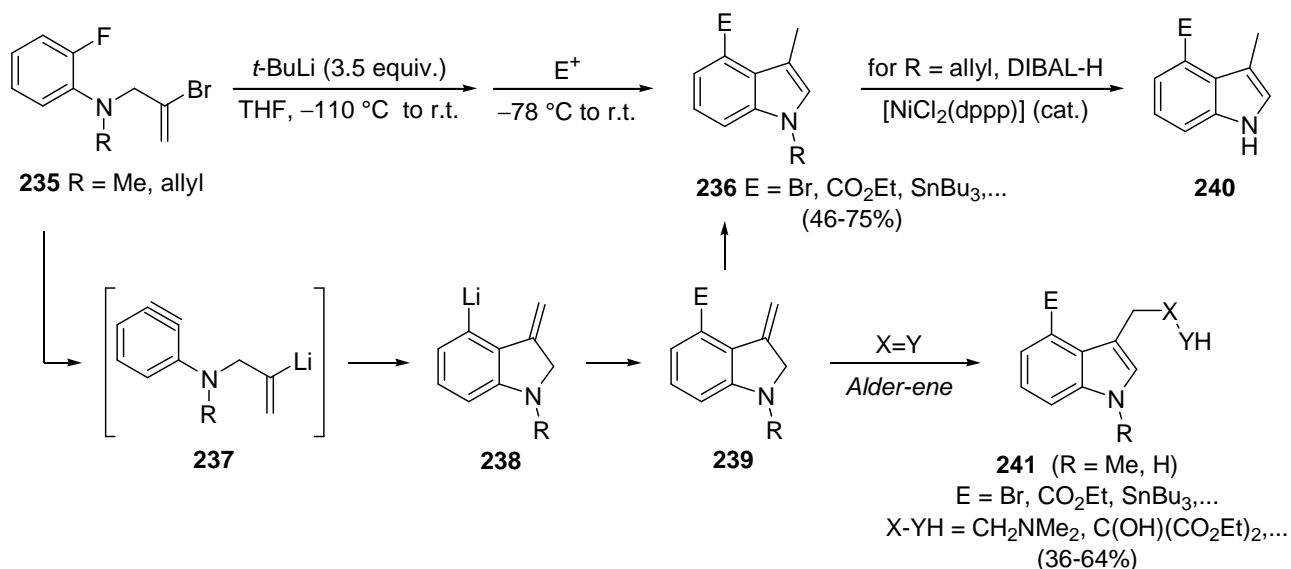

Scheme 62

We have extended the synthetic scope of this methodology to the preparation of functionalized tetrahydrocarbazole derivatives starting from a *N*-(2-bromo-cyclohex-2-enyl)aniline **242**.

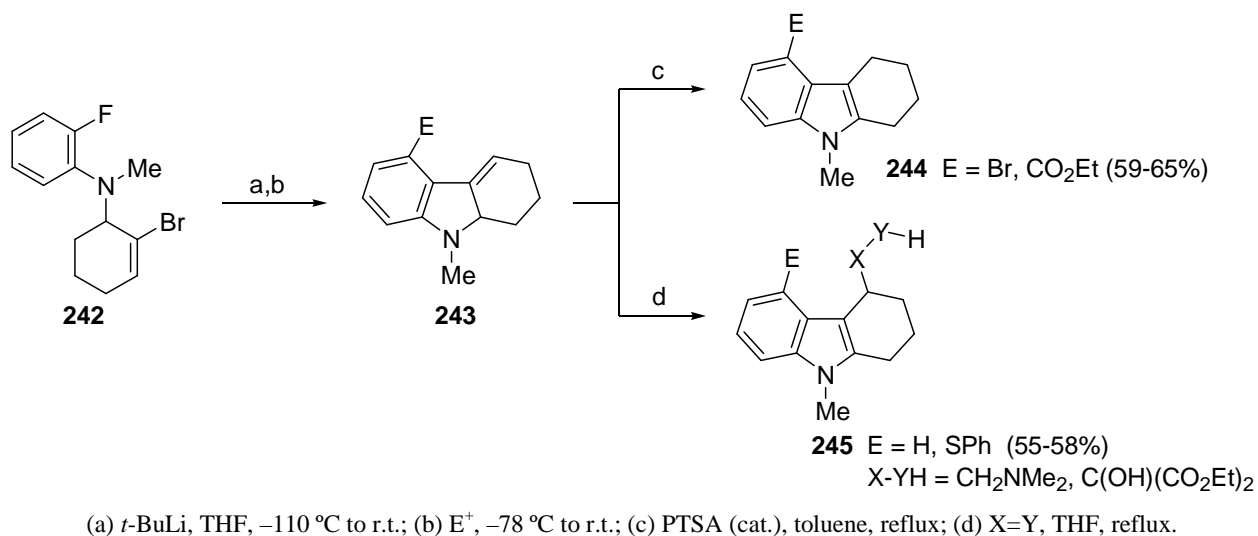

Scheme 63

In this case, the isomerization reaction of intermediate **243** required the addition of an acid catalyst in order to obtain the 5-functionalized tetrahydrocarbazole derivatives **244** (Scheme 63). As for compounds **239**, the addition of enophiles led to the formation of 4,5-difunctionalized tetrahydrocarbazole derivatives **245** (Scheme 63).^{77b}

In this area, we have also reported the intramolecular 5-*exo* anionic cyclization of benzyne-tethered aryllithiums. By a similar strategy as described above, regioselectively functionalized carbazole, dibenzofuran and dibenzothiophene derivatives **247a–c** were synthesized in fair to good yields starting from diarylamines, ether, and thioether **246a–c**, respectively. These diaryl compounds were prepared by classical aromatic nucleophilic substitution reactions or by Pd-catalyzed processes (Scheme 64).⁷⁸ Again, a benzyne intermediate **248**, which is generated by consecutive lithium-halogen exchange, abstraction of the proton *ortho* to the fluorine atom and elimination of lithium fluoride, is postulated.

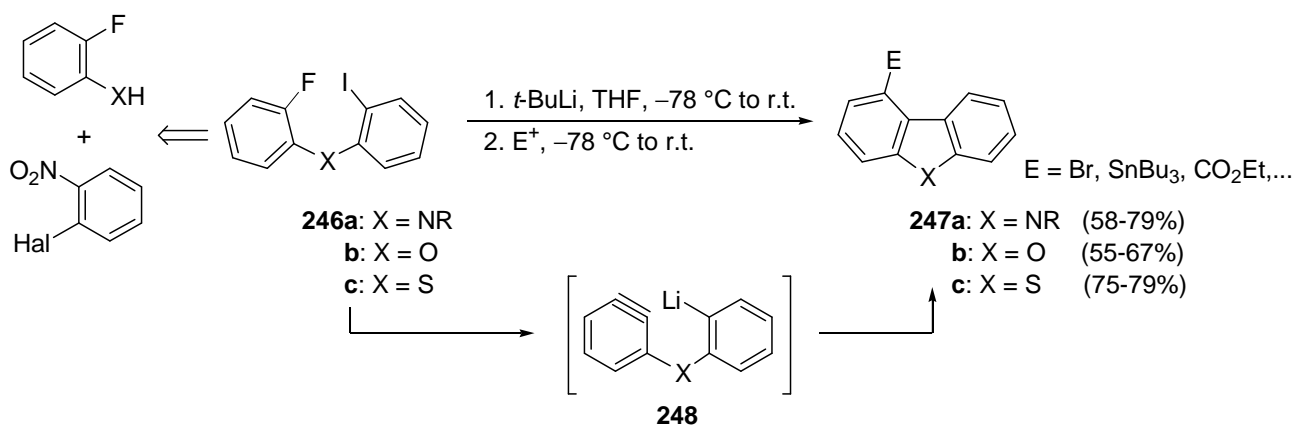

Scheme 64

Based on this methodology, we have also reported an efficient method for the synthesis of benzofused six-membered heterocycles: dihydrophenanthridines **250a,b**, dibenzopyrans **250c**, and dibenzothiophenes **250d**, regioselectively functionalized at the C-1 position. Starting 2-bromobenzyl 2-fluorophenyl amines, ether, and thioether derivatives **249a–d** were synthesized by conventional routes. Their treatment with *t*-BuLi and quenching with selected electrophiles led to the corresponding six-membered dibenzofused *N*-, *O*-, or *S*-heterocycles **250**, through intermediate benzyne **251** that undergoes a 6-*exo-dig* cyclization (Scheme 65).^{77b}

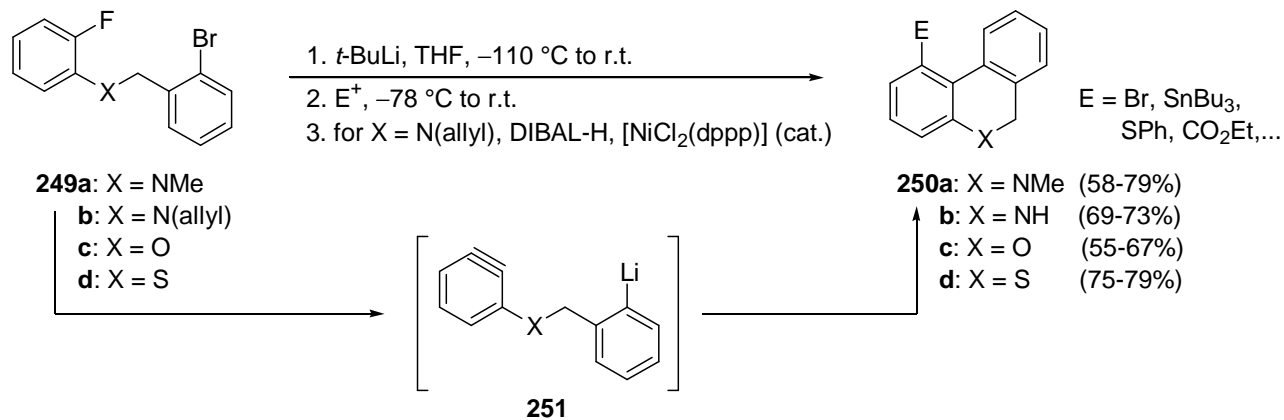

Scheme 65

By the *in situ* oxidation with PCC of the obtained heterocycles **250a,c**, functionalized phenanthridinones **252** and dibenzopyranones **253** could be efficiently synthesized without isolation of any intermediate (Scheme 66).⁷⁹ We have applied this strategy to the total syntheses of *Amaryllidaceae* alkaloids *Trisphaeridine* and *N-Methylcrinasiadine* in a “one-pot” procedure from readily available starting *N*-alkyl-*N*-(2-bromobenzyl)-2-fluoroanilines **254**. Again, dihydrophenanthridines intermediates **255** were not isolated. In the case of **255b**, after the allyl cleavage, the oxidation of the resulting *N*-H dihydrophenanthridine **255** (R=H) proceeds by formal dehydrogenation, affording the phenanthridine scaffold of *Trisphaeridine* (Scheme 66).⁷⁹

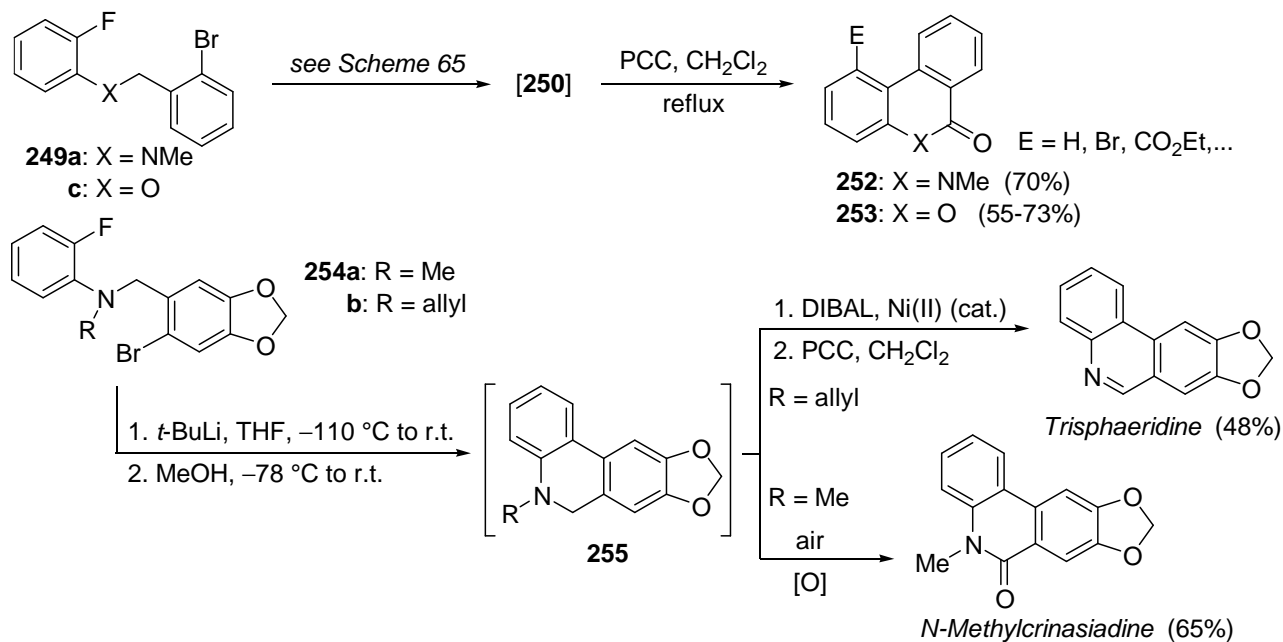

Scheme 66

4. Conclusions

Although non-activated alkenes and alkynes are not generally thought of as sites of nucleophilic attack, carbolithiation reactions constitute valuable transformations for constructing carbon–carbon bonds in tandem with generating a new organolithium species. Subsequent trapping by electrophiles offers an efficient means of expanding their synthetic utility. The intermolecular carbolithiation reaction of *ortho*-substituted styryl derivatives by alkyllithium compounds allows the preparation of a variety of heterocycles by further *in situ* ring closure involving the *ortho*-substituent. With convenient methods available for the generation of unsaturated organolithiums without the involvement of radical intermediates and a theoretical basis for predicting the stereochemical outcome of the intramolecular carbolithiation reactions, these processes provide a regioselective and highly stereoselective route to five-membered heterocycles. In addition, enantioselective carbolithiation reactions can be carried out by using the natural product (–)-sparteine as chiral ligand.

Acknowledgments

Continuous financial support from the Spanish Ministerio de Ciencia e Innovación, Junta de Castilla y León and Universidad de Burgos is gratefully acknowledged. Many thanks are due to Dr. F. Rodríguez, Prof.

Dr. F. J. Fañanás, and Prof. Dr. J. Barluenga (Universidad de Oviedo) for helpful comments. As far as our own contributions are concerned, we thank our co-workers Dr. Y. Fernández, Dr. J. M. Ignacio, Dr. C. Marcos and M. P. Castroviejo for their dedicated work.

References

1. Reviews: (a) Marek, I. *J. Chem. Soc., Perkin Trans. 1* **1999**, 535. (b) Bin, X.; Sheng-Ming, M. A. *Chin. J. Org. Chem.* **2000**, *20*, 54. (c) Clayden, J. In *Organolithiums: Selectivity for Synthesis*; Elsevier Science: Oxford, 2002; pp. 273. (d) Mealy, M. J.; Bailey, W. F. *J. Organomet. Chem.* **2002**, *646*, 59. (e) Normant, J. F. *Topics Organomet. Chem.* **2003**, *5*, 287. (f) Fañanás, F. J.; Sanz, R. In *The Chemistry of Organolithium Compounds*; Rappoport, Z.; Marek, I., Eds.; John Wiley & Sons: West Sussex, 2006; Vol. 2, Ch. 4, p. 295. (g) Hogan, A.-M. L.; O'Shea, D. F. *Chem. Commun.* **2008**, 3839.
2. For general reviews on carbometalation, see: (a) Knochel, P. In *Comprehensive Organic Synthesis*; Trost, B. M.; Fleming, I., Eds.; Pergamon Press: Oxford, 1991; Vol. 4, p. 865. (b) Marek, I.; Normant, F. J. In *Metal Catalyzed Cross-Coupling Reactions*; Diederich, F.; Stang, P., Eds.; Wiley VCH: Weinheim, 1998; p. 271. (c) Fallis, A.; Forgione, P. *Tetrahedron* **2001**, *57*, 5899.
3. Morton, M. *Anionic Polymerization: Principles and Practice*; Academic Press: New York, 1983.
4. Bartlett, P. D.; Friedman, S.; Stiles, M. *J. Am. Chem. Soc.* **1953**, *75*, 1771.
5. Wei, X.; Johnson, P.; Taylor, R. J. K. *J. Chem. Soc., Perkin Trans. 1* **2000**, 1109, and references cited therein.
6. Landgrebe, J. A.; Shoemaker, J. D. *J. Am. Chem. Soc.* **1967**, *89*, 4465.
7. Richey, H. G., Jr.; Heyn, A. S.; Erickson, W. F. *J. Org. Chem.* **1983**, *48*, 3821.
8. (a) Klein, S.; Marek, I.; Poisson, J.-F.; Normant, J.-F. *J. Am. Chem. Soc.* **1995**, *117*, 8853. (b) Norsikian, S.; Marek, I.; Normant, J.-F. *Tetrahedron Lett.* **1997**, *38*, 7523. (c) Norsikian, S.; Marek, I.; Klein, S.; Poisson, J.-F.; Normant, J.-F. *Chem. Eur. J.* **1999**, *5*, 2055.
9. (a) Coleman, C. M.; O'Shea, D. F. *J. Am. Chem. Soc.* **2003**, *125*, 4054. (b) Kessler, A.; Coleman, C. M.; Charoenying, P.; O'Shea, D. F. *J. Org. Chem.* **2004**, *69*, 7836.
10. (a) Cottineau, B.; O'Shea, D. F. *Tetrahedron Lett.* **2005**, *46*, 1935. (b) Cottineau, B.; O'Shea, D. F. *Tetrahedron* **2007**, *63*, 10354.
11. (a) Hogan, A.-M. L.; O'Shea, D. F. *J. Am. Chem. Soc.* **2006**, *128*, 10360. (b) Hogan, A.-M. L.; O'Shea, D. F. *J. Org. Chem.* **2008**, *73*, 2503.
12. (a) Hogan, A.-M. L.; O'Shea, D. F. *Org. Lett.* **2006**, *8*, 3769. (b) Hogan, A.-M. L.; O'Shea, D. F. *J. Org. Chem.* **2007**, *72*, 9557.
13. Cotter, J.; Hogan, A.-M. L.; O'Shea, D. F. *Org. Lett.* **2007**, *9*, 1493.
14. Hogan, A.-M. L.; Tricotet, T.; Meek, A.; Khokhar, S. S.; O'Shea, D. F. *J. Org. Chem.* **2008**, *73*, 6041.
15. Igawa, K.; Tomooka, K. *Angew. Chem. Int. Ed.* **2006**, *45*, 232.
16. Drozd, V. N.; Ustynyuk, Y. A.; Tsel'eva, M. A.; Dmitriev, L. B. *J. Gen. Chem. USSR* **1968**, *38*, 2047; *Zh. Obsch. Khim.* **1968**, *38*, 2144; *Chem. Abstr.* **1969**, *70*, 20115.
17. Bailey, W. F.; Patricia, J. J.; DelGobbo, V. C.; Jarret, R. M.; Okarma, P. J. *J. Org. Chem.* **1985**, *50*, 1999.
18. Ross, G. A.; Koppang, M. D.; Bartak, D. E.; Woolsey, N. F. *J. Am. Chem. Soc.* **1985**, *107*, 6742.
19. Bailey, W. F.; Ovaska, T. V.; Leipert, T. K. *Tetrahedron Lett.* **1989**, *30*, 3901.
20. Bailey, W. F.; Khanolkar, A. D.; Gavaskar, K.; Ovaska, T. V.; Rossi, K.; Thiel, Y.; Wiberg, K. B. *J. Am. Chem. Soc.* **1991**, *113*, 5720.
21. Chamberlin, A. R.; Bloom, S. H.; Cervini, L. A.; Fotsch, C. H. *J. Am. Chem. Soc.* **1988**, *110*, 4788.
22. See, for instance: (a) Bailey, W. F.; Tao, Y. *Tetrahedron Lett.* **1997**, *38*, 6157. (b) Krief, A.; Couty, F. *Tetrahedron Lett.* **1997**, *38*, 8085.
23. See, for instance: (a) Bailey, W. F.; Gavaskar, K. V. *Tetrahedron* **1994**, *50*, 5957. (b) Krief, A.; Kenda, B.; Remacle, B. *Tetrahedron* **1996**, *52*, 7435. (c) Lorthiois, E.; Marek, I.; Normant, J.-F. *Tetrahedron Lett.* **1996**, *37*, 6693.
24. Sanz, R.; Ignacio, J. M.; Rodríguez, M. A.; Fañanás, F. J.; Barluenga, J. *Chem. Eur. J.* **2007**, *13*, 4998.
25. See, for instance: (a) Bailey, W. F.; Ovaska, T. V. *Tetrahedron Lett.* **1990**, *31*, 627. (b) Bailey, W. F.; Ovaska, T. V. *J. Am. Chem. Soc.* **1993**, *115*, 3080.

26. Broka, C. A.; Lee, W. J.; Shen, T. *J. Org. Chem.* **1988**, *53*, 1336.
27. Broka, C. A.; Shen, T. *J. Am. Chem. Soc.* **1989**, *111*, 2981.
28. Lautens, M.; Kumanovic, S. *J. Am. Chem. Soc.* **1995**, *117*, 1954.
29. (a) Tomooka, K.; Komine, N.; Nakai, T. *Tetrahedron Lett.* **1997**, *52*, 8939. (b) Komine, N.; Tomooka, K.; Nakai, T. *Heterocycles* **2000**, *52*, 1071.
30. Rychnovsky, S. D.; Powers, J. P.; Lepage, T. J. *J. Am. Chem. Soc.* **1992**, *114*, 8375.
31. Rychnovsky, S. D.; Hata, T.; Kim, A. I.; Buckmelter, A. J. *Org. Lett.* **2001**, *3*, 807.
32. Rychnovsky, S. D.; Takaoka, L. R. *Angew. Chem. Int. Ed.* **2003**, *42*, 818.
33. Takaoka, L. R.; Buckmelter, A. J.; LaCruz, T. E.; Rychnovsky, S. D. *J. Am. Chem. Soc.* **2005**, *127*, 528.
34. Baldwin, J. E.; Dupont, W. A.; Ming, M. F. *J. Chem. Soc., Chem. Commun.* **1980**, 1042.
35. Nishiyama, H.; Isaka, K.; Itoh, K.; Ohno, K.; Nagase, H.; Matsumoto, K.; Yoshiwara, H. *J. Org. Chem.* **1992**, *57*, 407.
36. Nishiyama, H.; Sakata, N.; Motoyama, Y.; Wakita, H.; Nagase, H. *Synlett* **1997**, 1147.
37. Nishiyama, H.; Sakata, N.; Sugimoto, H.; Motoyama, Y.; Wakita, H.; Nagase, H. *Synlett* **1998**, 930.
38. Wakita, H.; Matsumoto, K.; Yoshiwara, H.; Hosono, Y.; Hayashi, R.; Nishiyama, H.; Nagase, H. *Tetrahedron* **1999**, *55*, 2449.
39. Bailey, W. F.; Punzalan, E. R. *Tetrahedron Lett.* **1996**, *37*, 5435.
40. Barluenga, J.; Fañanás, F. J.; Sanz, R.; Marcos, C. *Org. Lett.* **2002**, *4*, 2225.
41. Barluenga, J.; Fañanás, F. J.; Sanz, R.; Marcos, C. *Chem. Eur. J.* **2005**, *11*, 5397.
42. Sanz, R.; Marcos, C.; Martínez, A.; Fañanás, F. J. *Synlett* **2008**, 1957.
43. Johnson, F.; Subramanian, R. *J. Org. Chem.* **1986**, *51*, 5040.
44. (a) Le Strat, F.; Maddaluno, J. *Org. Lett.* **2002**, *4*, 2791. (b) Le Strat, F.; Harrowven, D. C.; Maddaluno, J. *J. Org. Chem.* **2005**, *70*, 489.
45. (a) Fressigné, C.; Girard, A.-L.; Durandetti, M.; Maddaluno, J. *Angew. Chem. Int. Ed.* **2008**, *47*, 891. (b) Fressigné, C.; Girard, A.-L.; Durandetti, M.; Maddaluno, J. *Chem. Eur. J.* **2008**, *14*, 5167.
46. Coldham, I.; Hufton, R. *Tetrahedron Lett.* **1995**, *36*, 2157.
47. Coldham, I.; Hufton, R. *Tetrahedron* **1996**, *52*, 12541.
48. (a) Coldham, I.; Hufton, R.; Rathmell, R. E. *Tetrahedron Lett.* **1997**, *38*, 7617. (b) Coldham, I.; Hufton, R.; Price, K. N.; Rathmell, R. E.; Snowden, D. J.; Vennall, G. P. *Synthesis* **2001**, 1523.
49. (a) Coldham, I.; Lang-Anderson, M. M. S.; Rathmell, R. E. *Tetrahedron Lett.* **1997**, *38*, 7621. (b) Coldham, I.; Price, K. N.; Rathmell, R. E. *Org. Biomol. Chem.* **2003**, *1*, 2111.
50. See, for instance: (a) Barluenga, J.; Sanz, R.; Fañanás, F. J. *Z. Naturforsch., Teil B* **1995**, *50*, 312. (b) Barluenga, J.; Sanz, R.; Fañanás, F. J. *J. Chem. Soc., Chem. Commun.* **1995**, 1009. (c) Barluenga, J.; Sanz, R.; Fañanás, F. J. *Chem. Eur. J.* **1997**, *3*, 1324.
51. Barluenga, J.; Sanz, R.; Fañanás, F. J. *Tetrahedron Lett.* **1997**, *38*, 2763.
52. Sanz, R.; Castroviejo, M. P.; Miguel, D.; Fañanás, F. J. *Lett. Org. Chem.* **2006**, *3*, 470.
53. Barluenga, J.; Fañanás, F. J.; Foubelo, F.; Yus, M. *J. Chem. Soc., Chem. Commun.* **1988**, 1135.
54. Barluenga, J.; Fañanás, F. J.; Sanz, R.; Fernández, Y. *C. R. Chimie* **2004**, *7*, 855.
55. Barluenga, J.; Sanz, R.; Granados, A.; Fañanás, F. J. *J. Am. Chem. Soc.* **1998**, *120*, 4865.
56. Fañanás, F. J.; Granados, A.; Sanz, R.; Ignacio, J. M.; Barluenga, J. *Chem. Eur. J.* **2001**, *7*, 2896.
57. Barluenga, J.; Fañanás, F. J.; Sanz, R.; Ignacio, J. M. *Eur. J. Org. Chem.* **2003**, 771.
58. Christoph, G.; Stratmann, C.; Coldham, I.; Hoppe, D. *Org. Lett.* **2006**, *8*, 4469.
59. Coldham, I.; Hufton, R.; Snowden, D. J. *J. Am. Chem. Soc.* **1996**, *118*, 5322.
60. Woltering, M. J.; Fröhlich, R.; Wibbeling, B.; Hoppe, D. *Synlett* **1998**, 797.
61. (a) Coldham, I.; Fernández, J.-C.; Snowden, D. J. *Tetrahedron Lett.* **1999**, *40*, 1819. (b) Coldham, I.; Fernández, J.-C.; Price, K. N.; Snowden, D. J. *J. Org. Chem.* **2000**, *65*, 3788.
62. (a) Coldham, I.; Vennall, G. P. *Chem. Commun.* **2000**, 1569. (b) Ashweek, N. J.; Coldham, I.; Snowden, D. J.; Vennall, G. P. *Chem. Eur. J.* **2002**, *8*, 195.
63. Tsuchida, S.; Kaneshige, A.; Ogata, T.; Baba, H.; Yamamoto, Y.; Tomioka, K. *Org. Lett.* **2008**, *10*, 3635.
64. Bahde, R. J.; Rychnovsky, S. D. *Org. Lett.* **2008**, *10*, 4017.
65. Zhang, D.; Liebeskind, L. S. *J. Org. Chem.* **1996**, *61*, 2594.

66. Bailey, W. F.; Jiang, X.-L. *J. Org. Chem.* **1996**, *61*, 2596.
67. Bailey, W. F.; Luderer, M. R.; Mealy, M. J. *Tetrahedron Lett.* **2003**, *44*, 5303.
68. Yokum, T. S.; Tungaturthi, P. K.; McLaughlin, M. L. *Tetrahedron Lett.* **1997**, *38*, 5111.
69. Bailey, W. F.; Salgaonkar, P. D.; Brubaker, J. D.; Sharma, V. *Org. Lett.* **2008**, *10*, 1071.
70. Bailey, W. F.; Mealy, M. J. *J. Am. Chem. Soc.* **2000**, *122*, 6787.
71. Sanz Gil, G.; Groth, U. M. *J. Am. Chem. Soc.* **2000**, *122*, 6789.
72. Mealy, M. J.; Luderer, M. R.; Bailey, W. F.; Bech Sommer, M. *J. Org. Chem.* **2004**, *69*, 6042.
73. Groth, U.; Köttgen, P.; Langenbach, P.; Lindenmaier, A.; Schütz, T.; Wiegand, M. *Synlett* **2008**, 1301.
74. Pedrosa, R.; Andrés, C.; Iglesias, J. M.; Pérez-Encabo, A. *J. Am. Chem. Soc.* **2001**, *123*, 1817.
75. Wei, X.; Taylor, R. J. K. *Tetrahedron Lett.* **2003**, *44*, 7143.
76. Bailey, W. F.; Longstaff, S. C. *J. Org. Chem.* **1998**, *63*, 432.
77. (a) Barluenga, J.; Fañanás, F. J.; Sanz, R.; Fernández, Y. *Tetrahedron Lett.* **1999**, *40*, 1049. (b) Barluenga, J.; Fañanás, F. J.; Sanz, R.; Fernández, Y. *Chem. Eur. J.* **2002**, *8*, 2034.
78. Sanz, R.; Fernández, Y.; Castroviejo, M. P.; Pérez, A.; Fañanás, F. J. *J. Org. Chem.* **2006**, *71*, 6291.
79. Sanz, R.; Fernández, Y.; Castroviejo, M. P.; Pérez, A.; Fañanás, F. J. *Eur. J. Org. Chem.* **2007**, 62.

OLIGO- AND POLY(2,5-THIENYLENE-ETHYNYLENE)S

Herbert Meier

Institut für Organische Chemie der Universität Mainz Duesbergweg 10–14, D-55099 Mainz, Germany
(e-mail: hmeier@mail.uni-mainz.de)

Abstract. Oligo- and poly(2,5-thienylene-ethynylene)s [OTE and PTE] represent a series of conjugated nanoparticles with interesting optical, electrical and optoelectronic properties. The synthetic approach to these molecular “wires” can easily be achieved by means of the Sonogashira-Hagihara reaction. Alkyl side chains (pendants) on the thiophene rings provide a good solubility and process ability. Moreover, OTE or PTE chains can serve as scaffold or linker for special chromophores, fluorophores or electrophores. The optical band gaps of OTEs converge to a limiting value for increasing numbers n of repeat units. This monotonous bathochromic shift $\lambda_{\max}(n+1) \geq \lambda_{\max}(n)$, which is usual for conjugated oligomers, can be reversed to a hypsochromic shift $\lambda_{\max}(n+1) \leq \lambda_{\max}(n)$, when a strong push-pull effect by terminal donor-acceptor substitution is present. The discussion of applications of OTEs and PTEs is focused in this article on the formation of charge carriers and on nonlinear optics.

Contents

1. Introduction
 2. Synthetic approach
 - 2.1. Monodisperse oligomers
 - 2.2. Multidisperse polymers
 3. Molecular structures
 4. Electronic absorption and fluorescence
 5. Applications in materials science
 6. Conclusion and outlook
- References and notes

1. Introduction

Conjugated oligomers and polymers attract steadily increasing attention because of their interesting properties in materials science and nanotechnology.¹ Major applications are in the field of semiconductors, photoconductors, light-emitting diodes, field effect transistors, solar cells, optical switches, photorefractive materials, nonlinear optics, molecular machines and sensors.

A lot of simple and composite repeat units are eligible for the construction of chains with an extended π conjugation. Within the scope of this article, 2,5-thienylene-ethynylene repeat units shall be discussed. The alternating sequence of thiophene rings and C \equiv C triple bonds leads to relatively rigid, rod-like oligomers or polymers (OTE or PTE). Such systems are often characterized as molecular wires. Because of solubility problems, the thiophene rings bear normally in 3- and/or 4-position (saturated) side chains. Scheme 1 visualizes for R¹≠R² the regio-regular OTEs/PTEs **1a** and **1b**, the regio-irregular chains **1c** and the chains **1d**, whose repeat units consist of two differently substituted 2,5-thienylene-ethynylene (2,5-thiophenediyl-1,2-ethynediyl) building blocks. In the previous 25 years a large number of such compounds has been investigated.^{2–42}

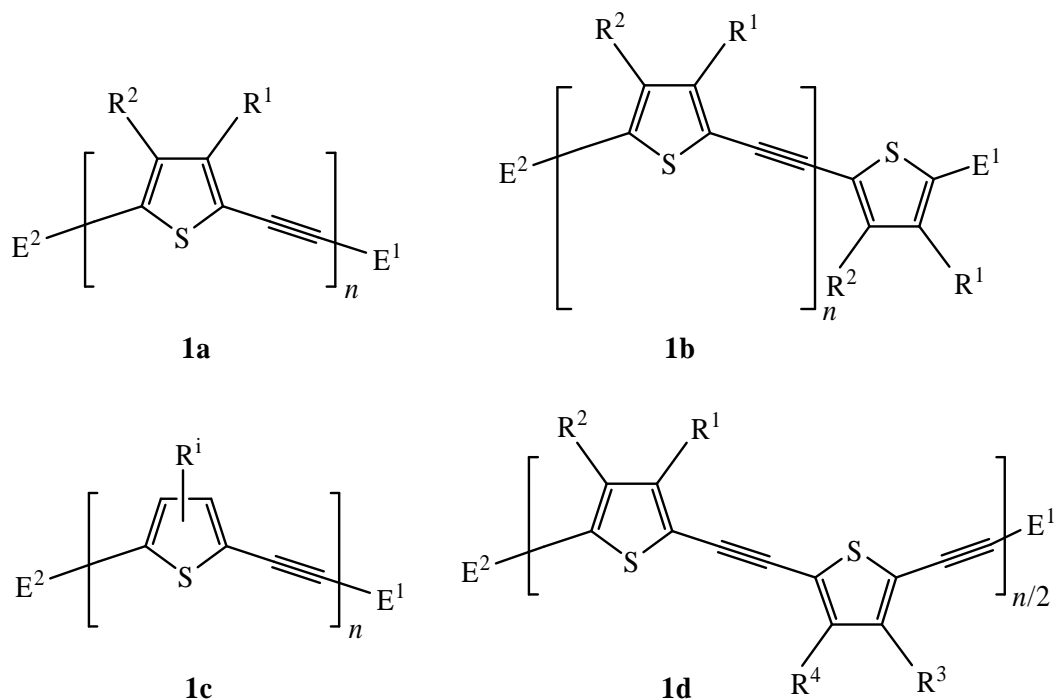

Oligo- and poly(2,5-thienylene-ethynylene)s **1a-d** [OTE, PTE], with pendants R^i on the thiophene rings and endgroups E^i ($i=1,2$).

Scheme 1

Related conjugated chains consist of repeat units with two thiophene rings and one triple bond⁴³ or one thiophene ring and two triple bonds.^{44,45} Moreover, there are numerous mixed systems, which are composed of 2,5-thienylene-ethynylene and other building blocks in a systematic arrangement.¹ⁿ

Apart from single OTE and PTE chains, linked OTE chains, star-shaped and dendritic systems with OTE arms and a cyclic system shall be discussed here.

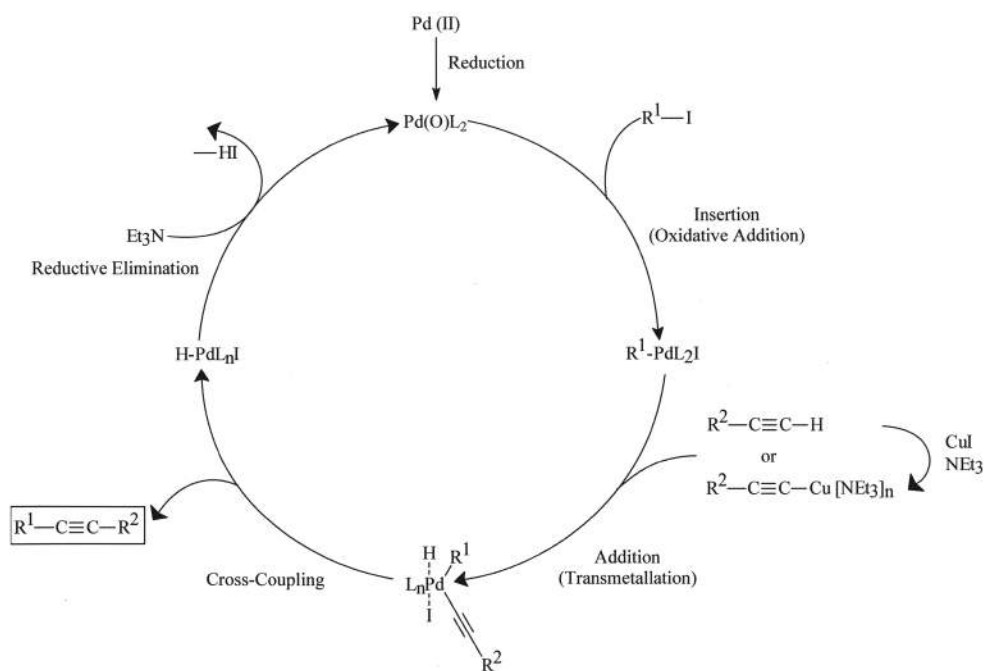

Suggested catalytic cycle of the Sonogashira-Hagihara reaction.^{1z}

Scheme 2

2. Synthetic approach

The Sonogashira-Hagihara method^{46,47} proved to be superior to other C(sp)-C(sp²) cross-coupling reactions such as the Stephens-Castro process⁴⁸ or the photochemical coupling.⁶ Thus, almost all OTEs and PTEs were prepared according to the Sonogashira-Hagihara protocol. A well-established mechanism of this versatile method is still lacking.⁴⁹⁻⁵² Scheme 2 shows our suggestion for the catalytic circle.^{1z} When Pd²⁺ salts are used, a primary reduction to Pd(0) has to take place.⁵³ Pd(0) is then inserted into the R¹-I (or R¹-Br) bond (R¹=thienyl). The co-catalyst CuI generates the copper acetylide from R²-C≡CH (R²=thienyl).⁵⁴ The acetylide anion adds to the Pd centre (transmetalation) and the cross-coupling to R¹C≡CR² can take place. In order to complete the catalytic circle, a reductive elimination occurs in which Pd(0) and HI are generated. The acid is trapped by the present base (triethylamine, piperidine, etc.).^{38,55} The yields of the Sonogashira-Hagihara reaction are normally good to excellent. Exceptions are specially mentioned in the text.

I One-directional chain extension

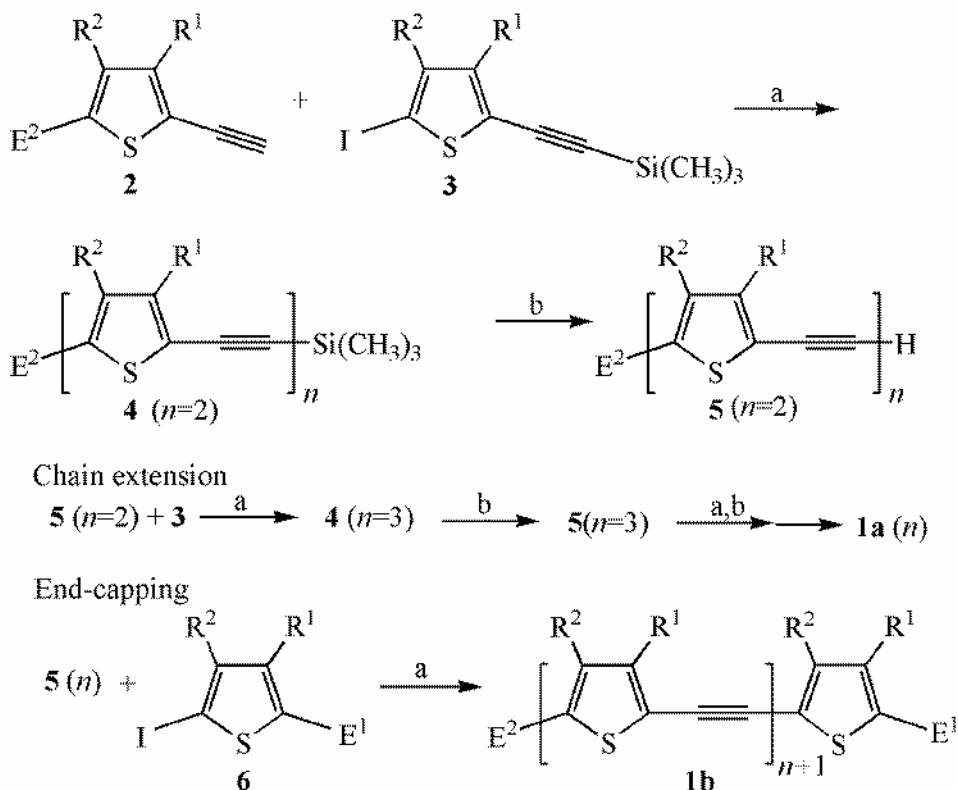

II Two-directional chain extension

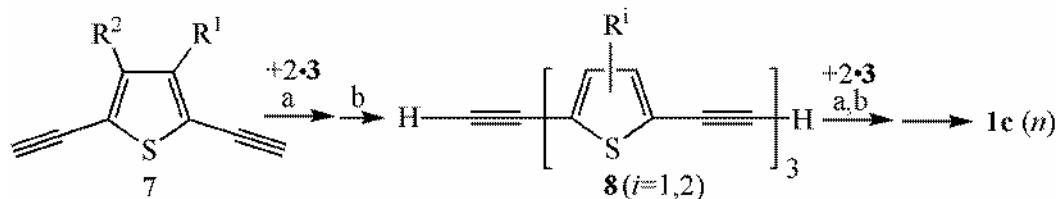





a: Pd(0), PPh₃, NEt₃; b: K₂CO₃

Synthesis of monodisperse OTEs **1a-c**.

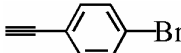
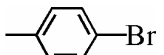
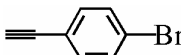
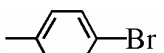
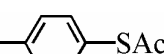
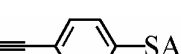
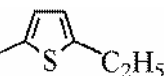
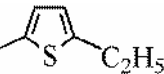
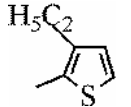
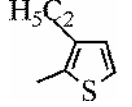
Scheme 3

Table 1. Examples of monodisperse OTEs of type **1a–d** ($n \geq 2$) with end groups E^1 , E^2 and pendants R^1 , R^2 , (R^3 , R^4).

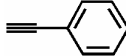
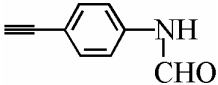
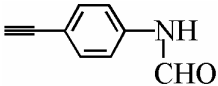
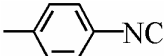
Structure type	Pendants		End groups		Repeat units n	References
	R^1	R^2	E^1	E^2		
1a	H	H	H	H	2	6, 35
1b	H	H	H	H	2–4	2, 8, 12, 22, 26, 33, 34
1a	H	H	CH ₂ OH	H	2	3
1a	H	H	H	OCH ₃	2–5	38
1b	H	H	H	OCH ₃	2–5	38
1a	H	H	H	SC ₁₂ H ₂₅	2–4	39
1a	H		Si(CH ₃) ₃	OCH ₃	2–5	38
1b	H	H	CHO	OCH ₃	2–5	38
1b	H	H	NO ₂	OCH ₃	2–5	38
1a	H	H	Si(CH ₃) ₃	SC ₁₂ H ₂₅	2–4	39
1b	H	H	NO ₂	SC ₁₂ H ₂₅	2–4	39
1b	H	H	CH=C(CN) ₂	OCH ₃	2–5	42
1a	C ₂ H ₅	H	H	H	2, 4, 8	13, 15, 23, 24
1a	C ₂ H ₅	H	Si(CH ₃) ₃	H	2, 4, 8, 16	13, 15, 16, 23, 24
1a	C ₂ H ₅	H	Si(CH ₃) ₃	I	2, 4, 8	13, 15, 23, 24
1a	C ₂ H ₅	H	H		8	23
1a	C ₂ H ₅	H			8	23
1a	C ₂ H ₅	H		I	16	23
1a	C ₂ H ₅	H		H	2, 4, 8	23
1a	C ₂ H ₅	H	Si(CH ₃) ₃		2, 4, 8, 16	23
1a	C ₂ H ₅	H	H	H	4, 8	25
1a	C ₂ H ₅	H		H	4, 8	25
1a	C ₂ H ₅	H		CHO	4, 8	25, 29
1a	C ₂ H ₅	H		H	2	27
1c	H/C ₂ H ₅			H	3	27

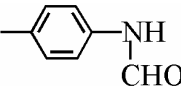
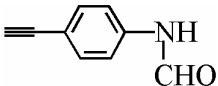
1c	H/C ₂ H ₅		Si(CH ₃) ₃	\equiv -Si(CH ₃) ₃	2	27
1d	C ₂ H ₄ OH	H	Si(CH ₃) ₃	H	2, 4	9
	R ³ ,R ⁴ =H, C ₂ H ₄ OH					
1b	C ₄ H ₉	C ₄ H ₉	H	H	2	37
	C ₄ H ₉	C ₄ H ₉	I	I	2	37
1b	C ₄ H ₉	C ₄ H ₉	CHO	CHO	4	37
1a	C ₄ H ₉	C ₄ H ₉		\equiv - 	6	37
1a	C ₆ H ₁₃	H	Si(CH ₃) ₃	I	2	36
1a	C ₆ H ₁₃	H	H		2, 4, 6, 8	36
1a	C ₆ H ₁₃	H	Si(CH ₃) ₃		2, 4, 6, 8	36
1c	H/C ₆ H ₁₃			\equiv - 	5, 9, 13, 17	36
1c	H/C ₆ H ₁₃			\equiv - 	5, 9, 13, 17	36
1c	H/C ₆ H ₁₃	H	H	\equiv -H	2	20
1c	H/C ₆ H ₁₃	Si(CH ₃) ₃	Si(CH ₃) ₃	\equiv -Si(CH ₃) ₃	2	20

2.1. Monodisperse oligomers

Mono- and two-directional chain constructions of monodisperse OTEs can start with **2** and **7**, respectively (Scheme 3). The bifunctional reaction partner **3** has to be protected on one side. Usually the ethynyl side is blocked by a Si(CH₃)₃ group,^{56,57} which can be easily cleaved by alkaline treatment, so that the next chain extension step can follow. An end-capping can transform the product type **1a** [with E¹=H, Si(CH₃)₃] to **1b** with various possible end groups E¹ (route I).

The bidirectional route II (Scheme 3), compared to route I, has the advantage that the chain is elongated by two repeat units in each step. However, a regio-irregular product **1c** is formed for R¹≠R².

Table 1 gives a survey over OTEs, which were almost exclusively synthesized by the processes summarized in Scheme 3. The only exception is found in reference.⁶

Related series of OTEs, for example push-pull systems [DAOTEs] with the same electron donor group (E²=D) but different electron acceptor groups (E¹=A), can be prepared on the basis of a fundamental series **1a** (E¹=H, E²=D) and final end-capping steps with **6** (E¹=A). Thus, monodisperse products **1b** (E²=D, E¹=A) can be obtained. An example is shown in Scheme 4. The fundamental series with OCH₃ as donor group was elongated in the usual way **9**→**10**→**11**→**12**. Different end-capping steps with the iodine components **13**, **15** and **17** led then for each *n* to **14**, **16** and **18**.³⁸ The formyl group in **18** can be used for the introduction of further functional groups or sub-structures. The reaction with malononitrile **19** led to **20**.³⁹

It is advisable to start the chain extension on the donor side. However, an opposite chain elongation, which starts on the acceptor side, is also possible, provided that the solubility is sufficient. A serious

solubility problem exists for **1a–d** with $R^1=R^2=E^2=H$, and $E^1=H$, TMS. The conjugated OTE chain can be used in various modes as scaffold or tether for the attachment of special chromophores, fluorophores, electrophores, ligands for metal complexes, radicals, etc..

Aso, Otsubo *et al.* fixed [60]fullerene on oligo(2,5-thienylene-ethynylene)s.²⁵ The strong fluorescence quenching by the fullerene chromophore indicates an efficient intramolecular energy and/or electron transfer in a through-bond fashion (Scheme 5).^{25,29}

Extension of the fundamental OTE chain

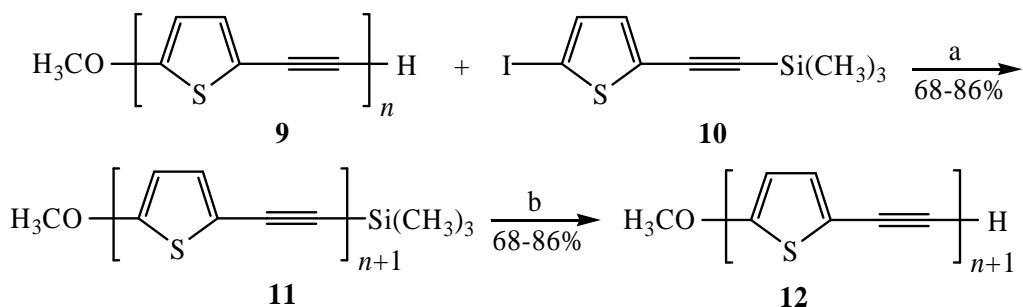

End-capping to different DAOTEs

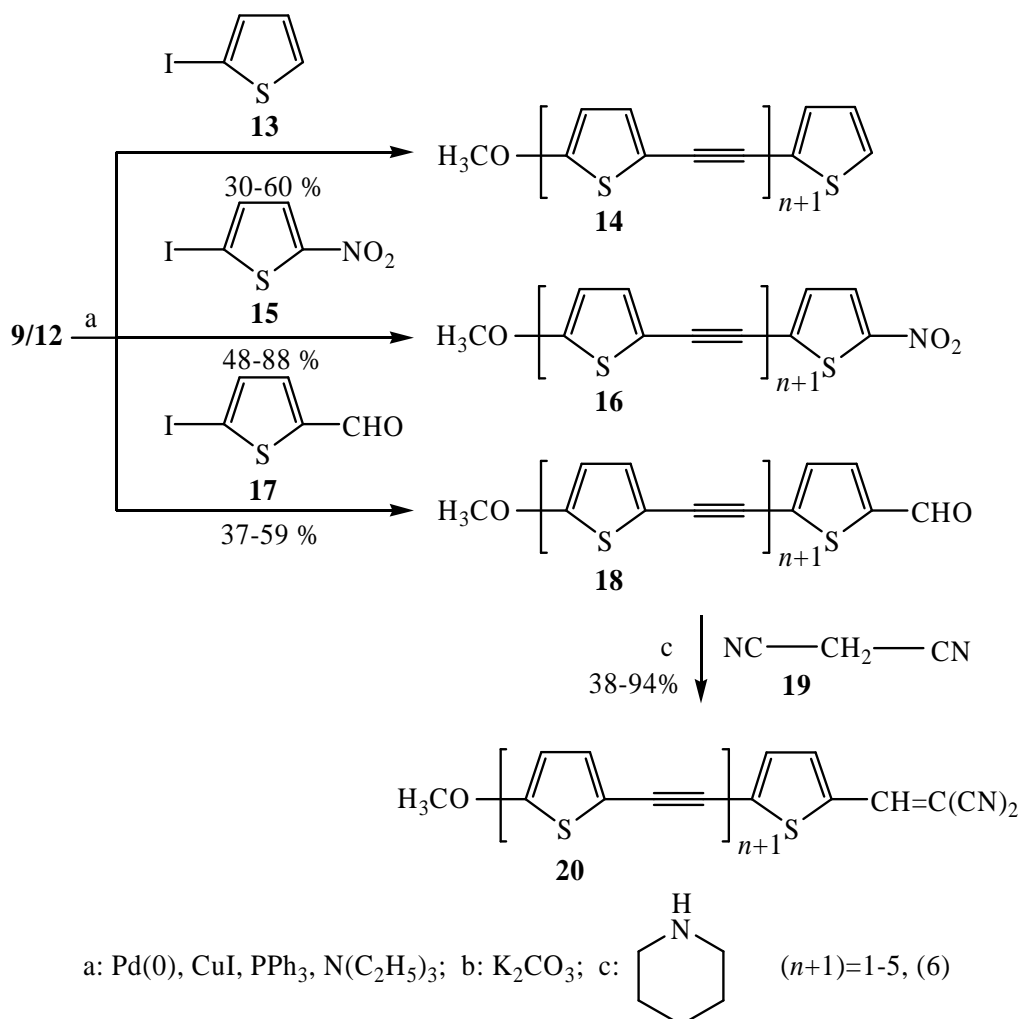

Preparation of DAOTEs on the basis of an auxiliary OTE series.^{38,39,42}

Scheme 4

The iterative chain extension by one repeat unit, each time, can be improved for $E^2=H$ by an elegant method found by Tour *et al.*¹³ A protected intermediate **1a** (n) is partitioned into two portions; one portion is deprotected, the other is selectively iodinated (LDA/I₂, low temperatures) in the terminal position ($E_2=I$). The Sonogashira-Hagihara protocol yields then a chain with doubled length: **1a** (n , $E^1=H$, $E^2=H$) + **1a** (n , $E^1=Si(CH_3)_3$, $E^2=I$) \rightarrow **1a** ($2n$, $E^1=Si(CH_3)_3$, $E^2=H$). Thus, a series with $n=2, 4, 8$ and 16 was obtained.¹³

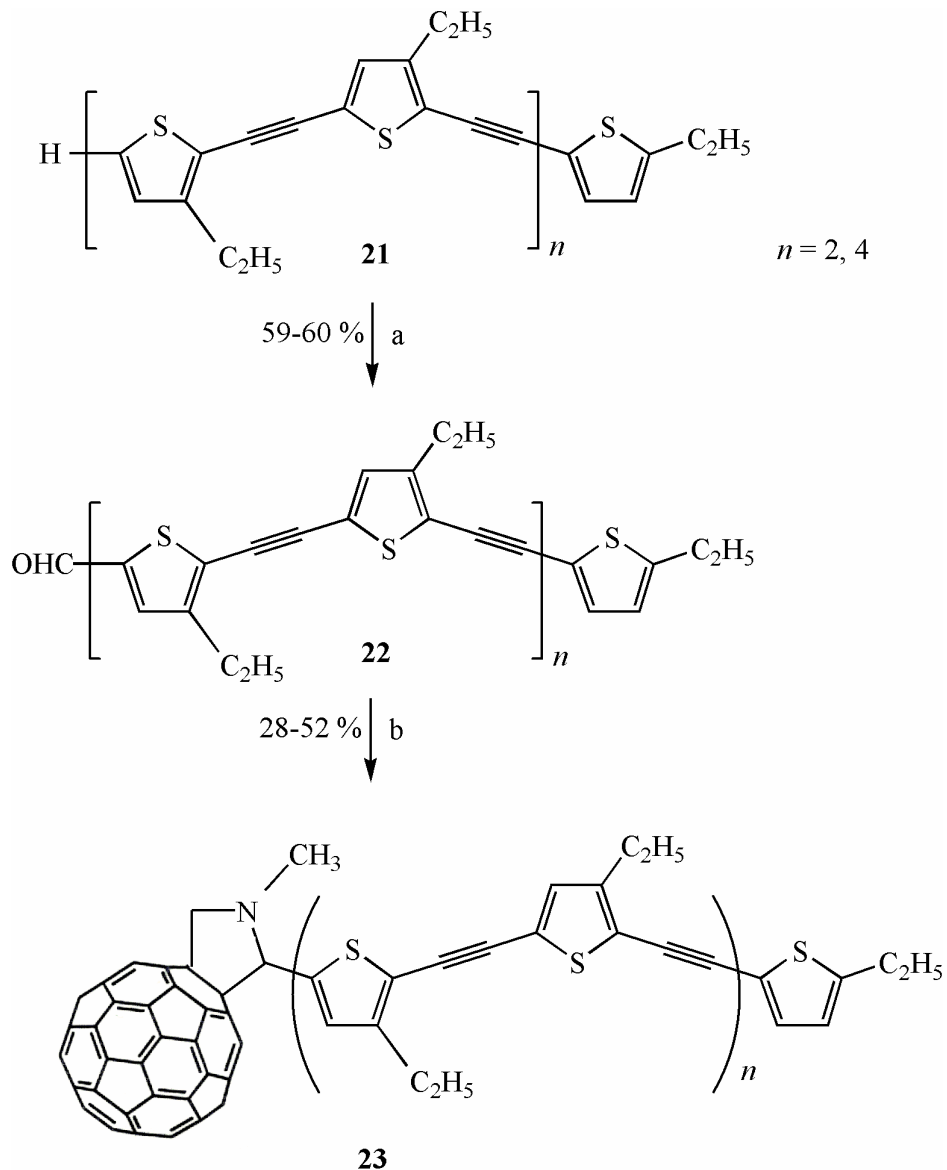

a: LDA, DMF; b: C₆₀, H₃C-NH-CH₂-COOH
Attachment of C₆₀ on OTE chains.²⁵

Scheme 5

The interaction of an oligo(2,3-thienylene-ethynylene) chain with an analogously linked [60]fullerene occurs in a through-space fashion.²⁵

Scheme 6 shows an example, where a terpyridine unit as desired end group is introduced in the first step of the OTE chain construction. On the basis of 4'-ethynyl-2,2':6',2''-terpyridine, Ziessel *et al.*^{30,31} implemented progressively thienylene-ethynylene units. The 2-hydroxy-2-propyl group served as protecting

group, which could be split off by KOH. Thus, the oligomers **24** and **25** with one terpyridine and the series **26** with two terpyridine end groups were obtained.^{30,31} The terminal terpyridine ligands of **26** should open the door to multinuclear transition metal complexes for a novel type of molecular wire in which directional information transfer can be expected.

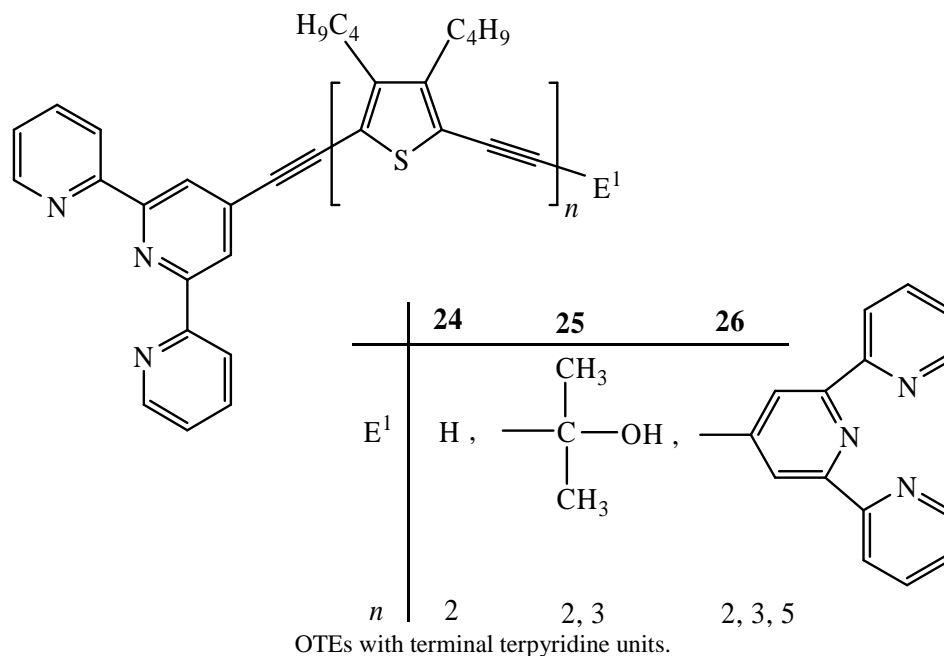

Scheme 6

Due to their electron-deficient properties, 1,3,4-oxadiazole derivatives are interesting electron-transporting/hole-transport blocking materials. Moreover, they exhibit often an efficient photoluminescence. Bryce *et al.*³² synthesized in this context compound **27**, which has 5-aryl-1,3,4-oxadiazol-2-yl end groups on a short OTE chain of type **1b** (Scheme 7).

Matsuda, Irie *et al.*³³ prepared a nitroxide biradical **28** with an OTE tether. The central thiophene ring bears a thienylvinylene sub-structure, which should permit an optical switching by a reversible electrocyclic [π^6a] process. Consequently, an alternate interaction of the terminal radical centres could be expected. However, compound **28** proved to be photostable.³³

A planar star-shaped system **29** was obtained by Mann and Pappenfus.²⁸ The deep maroon solid was prepared in 38% yield by a Sonogashira-Hagihara reaction of tetrabromothiophene and the corresponding alkyne, 3',4'-dibutyl-5-ethynyl-5''-phenyl-2,2':5',2''-terthiophene.²⁸

Non-planar multi-arm (cruciform) systems were obtained, when spiro compounds served as core. Tour *et al.*¹⁵ prepared the spiro-fluorene derivative **32** and the related compounds **33** and **34**. The fourfold cross-coupling works very well for **32** (97%) and **33** (78%), but unsatisfying for **34** (<10%).

Ma, Pei *et al.*³⁴ synthesized a family of π -conjugated dendrimers based on truxene and thienylene-ethynylene building blocks (Scheme 9). Truxene represents core and branching unit. Trithienyltruxene **35** was iodinated with *N*-iodosuccinimide (NIS) to **36**. The subsequent Sonogashira-Hagihara reaction with 2-ethynyl-5-thienylethynyl-thiophene led to **37**, which was again regioselectively iodinated (**37**→**38**). Aldehyde **39** was transformed to the alkyne **40** by Wittig reaction and dehydrobromination. On the other hand, **39** was iodinated to **41** and cross-coupled with **40** to **42**.

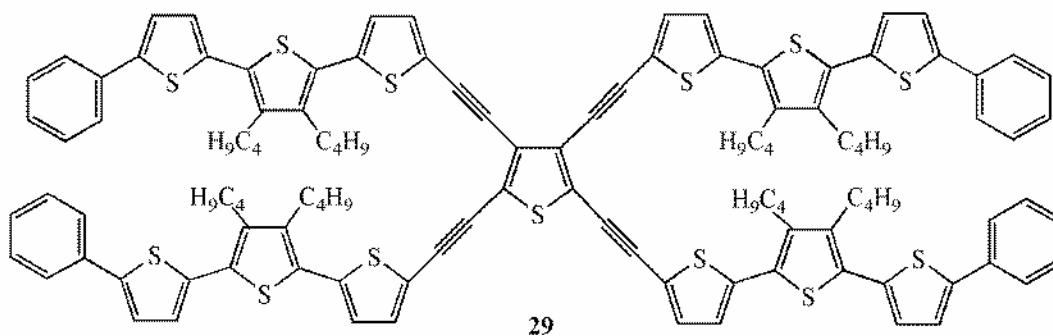
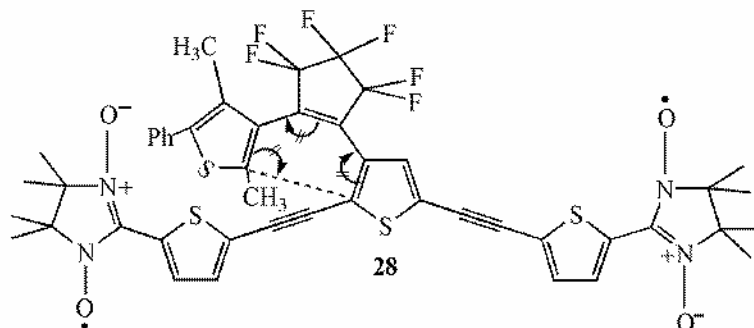
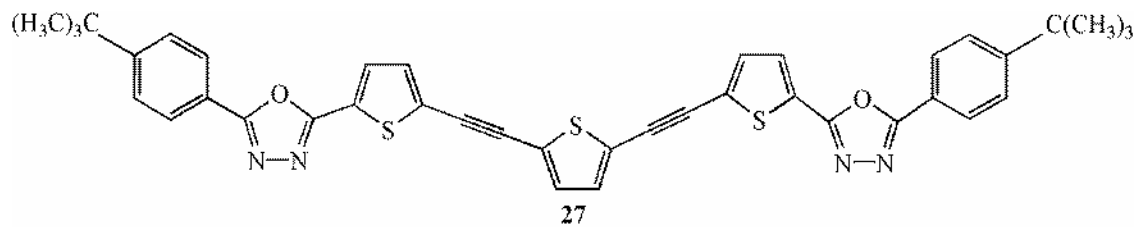

Scheme 7

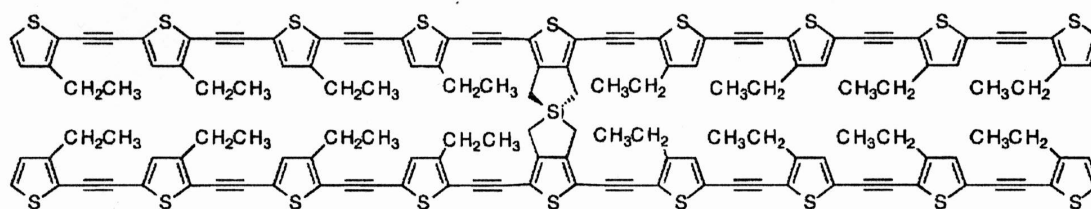
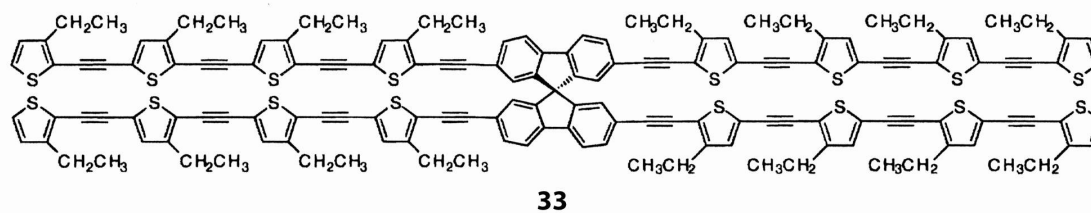
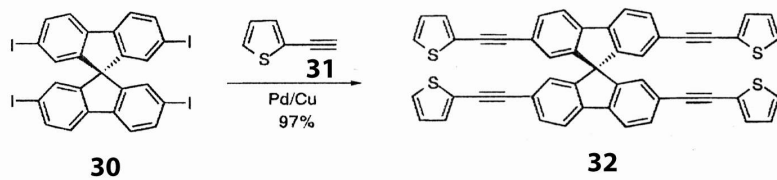

Scheme 8

Wittig reaction and dehydrobromination yielded **43**. The triiodo compound **36** and the ethynyl component **40** afforded dendrimer **44** and the triiodo compound **38** and the ethynyl system **43** furnished the higher dendrimer **45**. The elegant synthetic approach by a convergent/divergent strategy looks complicated but is based on just four reaction procedures a–d.

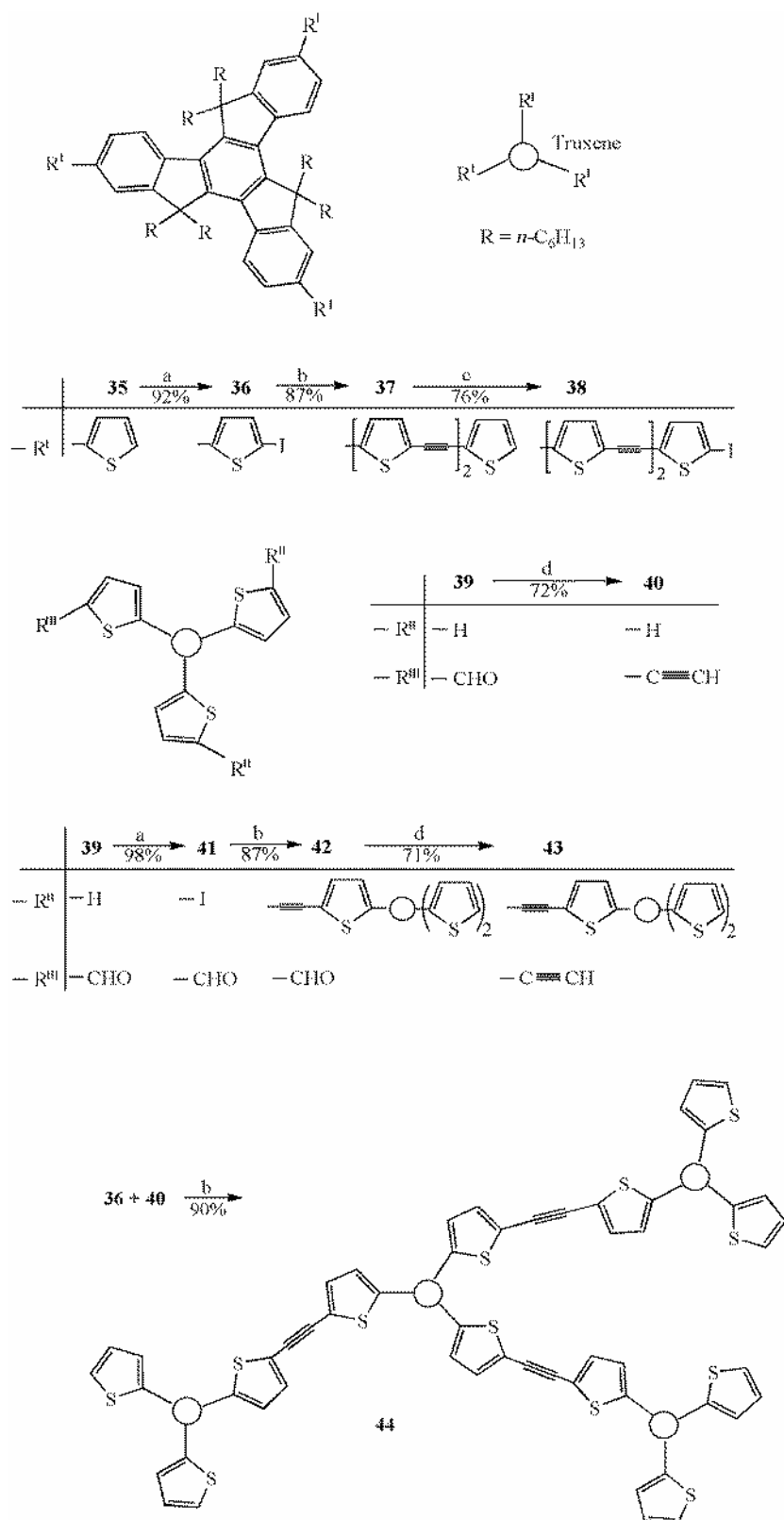

Scheme 9 (Part 1)

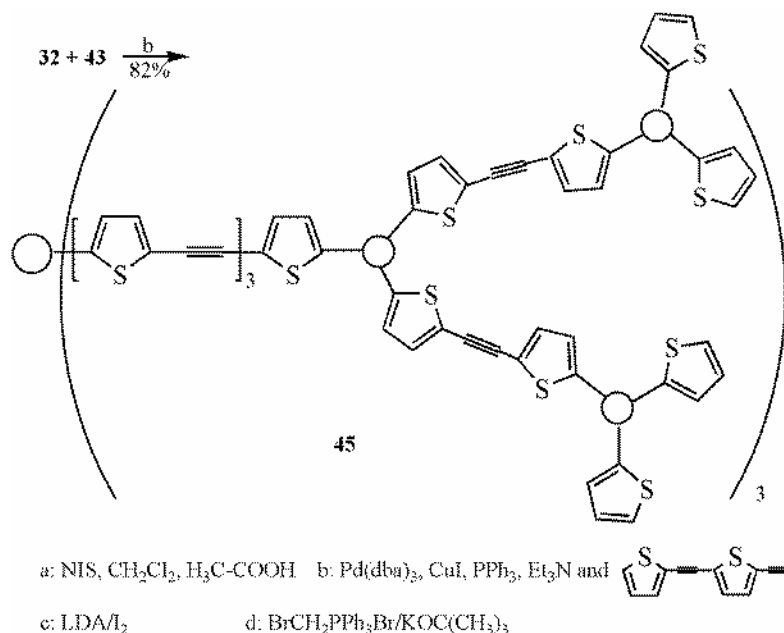

Synthesis of two generations (**44**, **45**) of dendrimers, which contain 2,5-thienylene-ethynylene building blocks and truxene as core and branching unit.

Scheme 9 (Part 2)

Finally a cyclic OTE shall be discussed here. Dialdehyde **46** was subjected by Iyoda *et al.*³⁷ to a McMurry condensation. The cyclization afforded the stereoisomeric dimers **47**, trimer **48**, tetramer **49**, pentamer **50** and hexamer **51** (with decreasing yield). The dimer fraction **47** consisted of 30% (*E,E*) configuration and 7% (*E,Z*)/(*Z,Z*). Compound (*E,E*)-**47** was separated by GPC and crystallization and then transformed to the cyclic oligo(2,5-thienylene-ethynylene) **52** by addition of Br₂ (large excess) and dehydrobromination (Scheme 10). The outer perimeter is a 60-membered conjugated ring.

2.2. Multidisperse polymers

The Sonogashira-Hagihara reaction is the method of choice for the preparation of OTEs as well as of the corresponding polymers PTE. Bifunctional compounds **53** of the AB type undergo a higher polycondensation process when the pendants R¹ and R² provide a reasonably good solubility (Scheme 11). 2-Ethynyl-3-hexyl-5-iodothiophene (**53**, R¹=C₆H₁₃, R²=H), for example, afforded a polymer **54** with an average *n* of 56 repeat units and a polydispersity *M_w/M_n* of 1.9.^{20,21} 2-Bromo-5-ethynylthiophene, which does not contain a solubilizing side chain, yielded a low-molecular weight polymer (*M_n*=1020–1140, *M_w*=1350–2170, *M_w/M_n*=1.32–1.90, 20–29% conversion). When a 3,5-di(*tert*-butyl)-4-hydroxyphenyl substituent was attached to 3-position of 5-bromo-2-ethynylthiophene, the polycondensation triggered by Pd(PPh₃)₄/CuI gave a PTE with *M_n*=770 (GPC measurement).

In addition to this AB-type, an AA-BB type polycondensation can be applied. When compound **7**, which was used for the two-directional chain growth in Scheme 3, is reacted with the diiodo component **55**, a regio-random polymer **56** is formed (R¹≠R²). A symmetrical dimer such as **57** yields with the symmetrical diiodo component **59** a regio-regular polymer **61** with an alternating sequence R¹R¹ R²R² R¹R¹... of side chains. Apart from the chain ends, the same polymer **61** can be obtained by the polycondensation of **58** and **60**. Regio-regular polymers can principally also be formed by the combination of **57** and **60** or **58** and **59** (Scheme 11).

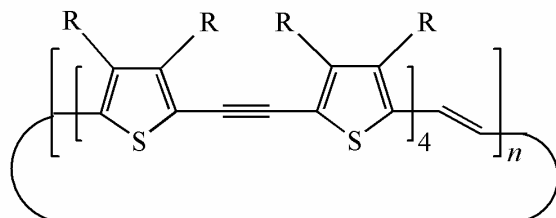
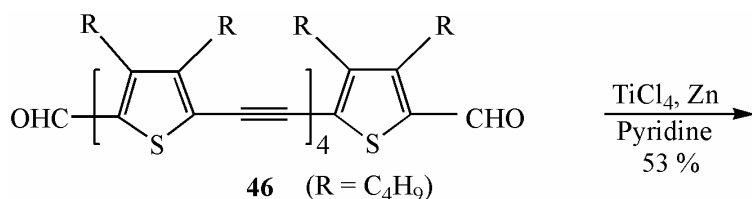

Cmpd	<i>n</i>	Yield [%]
47	2	32 (+7)
48	3	9
49	4	6
50	5	4
51	6	2

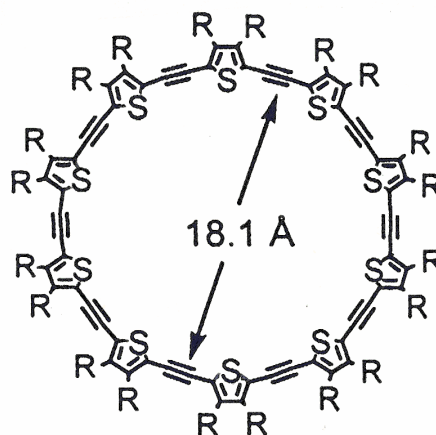
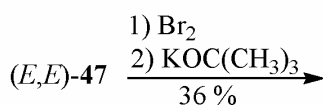

52

Preparation of the cyclic deca(2,5-thienylene-ethynylene) **52** with 20 *n*-butyl groups.

Scheme 10

2,5-Diethynylthiophene **7** (R¹=R²=H) and 2,5-diiodothiophene **55** (R¹=R²=H) yielded a red-brown insoluble polymer, which contained some soluble oligomers.^{5,7} An FT-IR study of the polymer gave the number average molecular mass $M_n=3400$.⁷ Better studied was the dark-brown PTE **56**, which was obtained from 3-hexyl-2,5-diethynylthiophene **7** (R¹=C₆H₁₃, R²=H) and 3-hexyl-2,5-diiodothiophene **55** (R¹=C₆H₁₃, R²=H).^{10,11,14,17} Light-scattering measurements gave an M_w value of 190 000.¹⁴ Apart from the regio-random PTE **56**, a regio-regular chain **61** with hexyl pendants was prepared from **57** (R¹=C₆H₁₃, R²=H) and **59** (R¹=C₆H₁₃, R²=H).^{20,21} An alternate head-to-head/head-to-tail arrangement is realized in **61** (Scheme 11).

Meijer *et al.*⁴¹ studied chiral PTEs **64**, which were obtained from **62** and **63** (Scheme 12).

Finally, a nanocomposite of poly(2,5-thienylene-ethynylene) and silica shall be mentioned, which was obtained from 2,5-diiodothiophene, acetylene and silica.⁵⁸

3. Molecular structures

Uniform OTEs with a certain defined number of repeat units *n* represent rod-like molecules of a defined length $L(n)$ in the nano-scale. Rotations about the single bonds lead in the idealized planar

arrangement to different conformers in which neighbouring thiophene rings can have *syn* or *anti* orientation (Scheme 13). The zig-zag (*all-anti*) form has the lowest energy.

a) AB Type

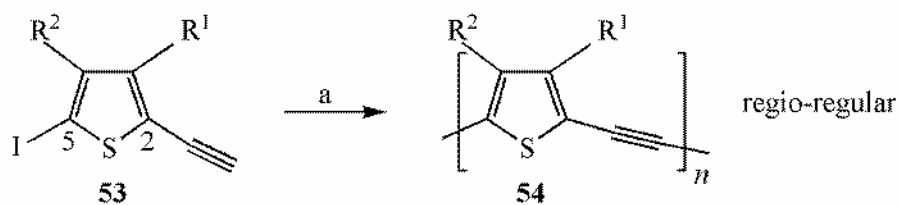

b) AA—BB Type

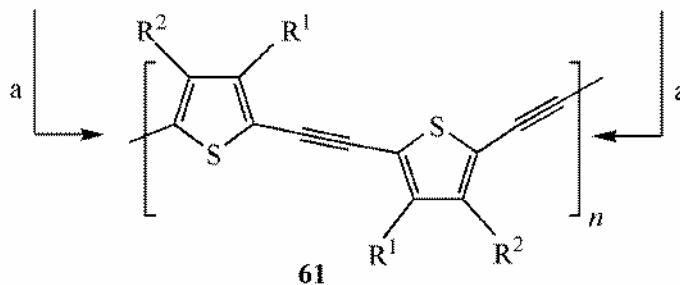
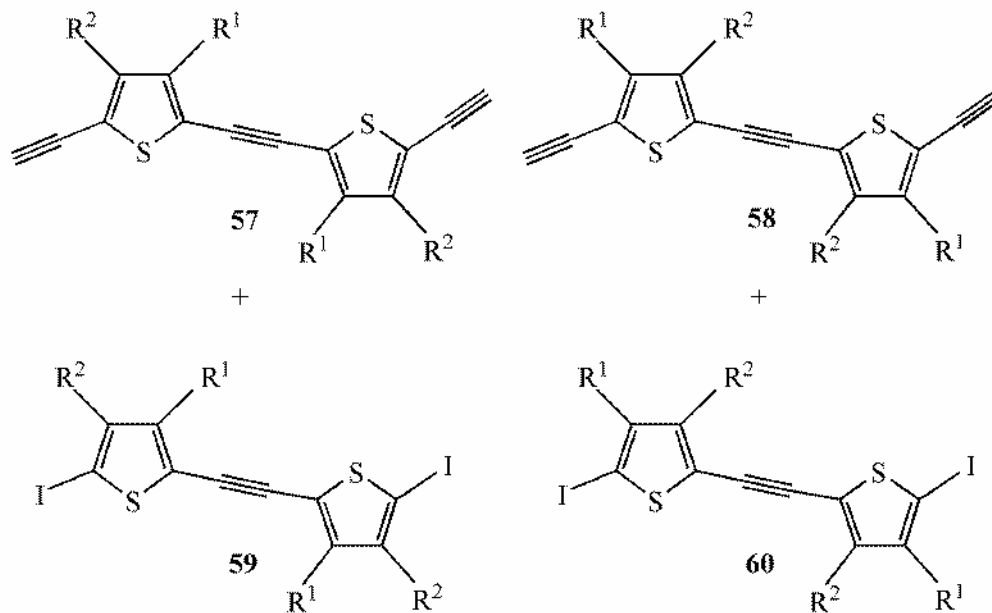
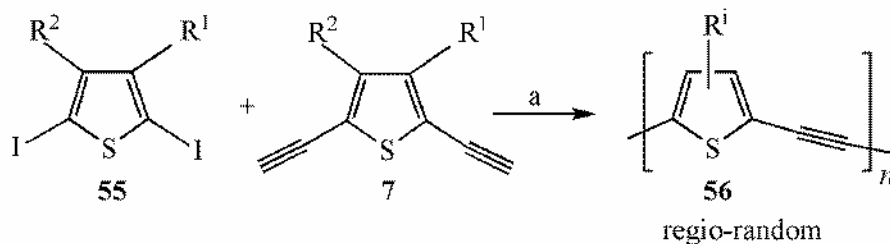

a: Pd(0), CuI, base

Polycondensation reactions of the AB- and AA-BB type.

Scheme 11

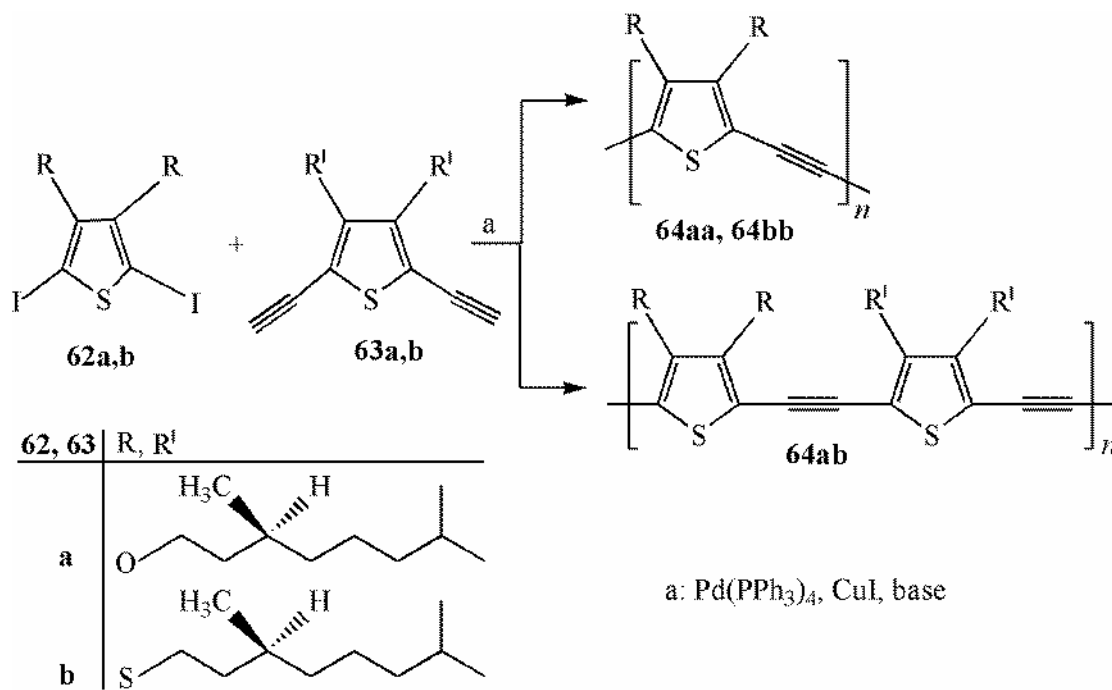

	M_n [g mol ⁻¹]	M_w [g mol ⁻¹]	M_w / M_n
62a + 63a \xrightarrow{a} 64aa	13370	23440	1.8
62b + 63b \xrightarrow{a} 64bb	14800	39600	2.7
62a + 63b \xrightarrow{a} 64a,b	15470	33700	2.2

Preparation of alkoxy and/or alkylsulfanyl substituted PTEs.

Scheme 12

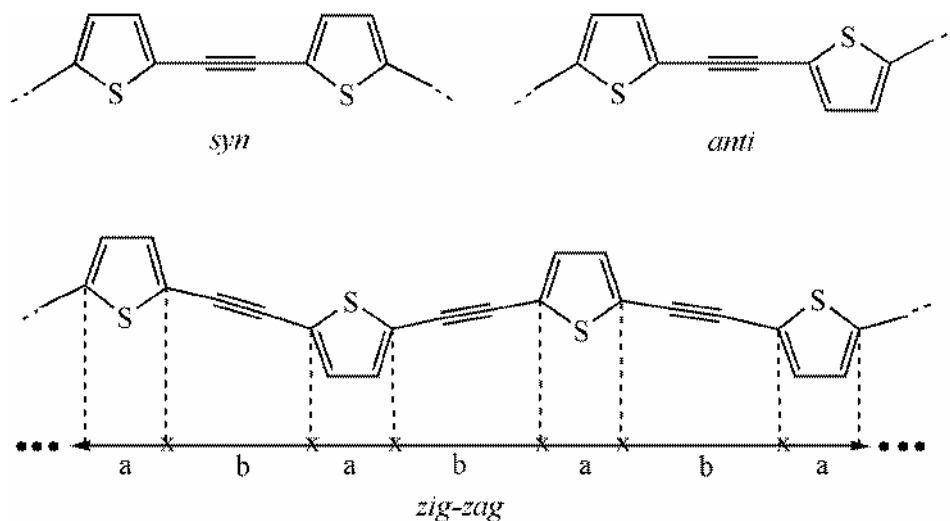

Conformations of OTEs and PTEs and calculation of the chain length L .

Scheme 13

However, the energy difference between the *zig-zag* conformer and other conformers is low – in any case lower than for the corresponding oligo(2,5-thienylene)s [oligothiophenes]. OTEs of types **1a–c** and n repeat units have N possible planar conformers:

$$\mathbf{1a, 1c} \quad N = 2^n \quad (1)$$

$$\mathbf{1b} \text{ (} R^1 \neq R^2 \text{ or } E^1 \neq E^2 \text{)} \quad N = 2^n \quad (1)$$

$$\mathbf{1b} \text{ (} R^1 = R^2 \text{ and } E^1 = E^2 \text{)} \quad N = 2^{n-2} + 2^{n-k/2} \quad k = \begin{cases} 1 & \text{for odd } n \\ 2 & \text{for even } n \end{cases} \quad (2)$$

The reduced number N in the latter case is due to the higher symmetry.^{1x} The equations (1) and (2) demonstrate that the number N increases strongly with increasing numbers n of repeat units. A symmetrical OTE chain **1b** with $n=16$ repeat units would have 32.896 possible conformers. The longest known OTE chains with 16^{23} and 17^{36} repeat units, respectively, are unsymmetrical and have even more possible conformers. There are always two “extreme” conformations, namely the favorable *all-anti* or *zig-zag* arrangement and the *all-syn* orientation. Although the latter has a low probability, it represents the reactive species in the cyclization shown in Scheme 10.

The length $L(n)$ in the preferred *zig-zag* conformation of the OTE type **1b** can be calculated according to Scheme 13 and equation (3):

$$L(n) = (n + 1)a + n \cdot b \text{ nm} \quad a = 0.247 \text{ nm}, b = 0.388 \text{ nm} \quad (3)$$

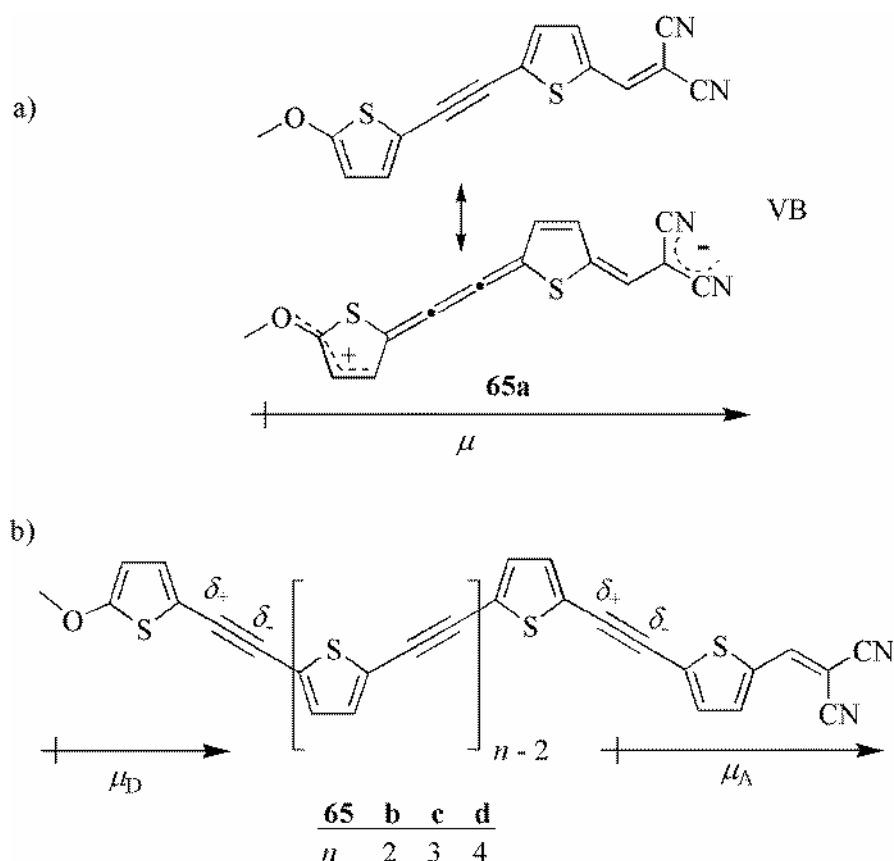

Visualization of the push-pull effect of the DAOTEs **65a–d**: a) VB model; b) model with terminal partial dipole moments, whose interaction decreases with increasing distance between donor and acceptor.⁴²

Scheme 14

The values of the parameters a and b correspond to the crystal structure analysis of a hexamer **1a** ($R^1=R^2=C_4H_9$, $E^1=C_6H_5$, $E^2=C_6H_5 \equiv$).³⁷ The longest monodisperse OTEs with 16^{23} or 17^{36} repeat units are

rod-like nanoparticles with $L > 10$ nm. A curling of the OTE chain, which is due to *syn* arrangements, shortens the distance between the terminal sp^2 or sp carbon atoms of the conjugated chain; $L(n)$ of equation (3) corresponds therefore always to the maximum extension.

Polar end groups convey the OTEs a polarization along the chain. The effect is particularly pronounced for push-pull systems (DAOTEs) with an electron-donating and an electron-accepting end group.^{38,39,42} Scheme 14 illustrates the polarization for OTEs **65** with $D = OCH_3$ and $A = CH=C(CN)_2$.⁴² The monomer **65a** can be described in terms of the valence bond theory (VB) by an electro-neutral and a zwitterionic resonance structure. Higher members **b–d** of the push-pull series **65** ($n \geq 2$) are better described by terminal segments having partial dipole moments μ_D and μ_A .^{1v,1x} The dipole-dipole interaction decreases with increasing length of the chain.

¹³C Chemical shifts are very sensitive to partial charges on the corresponding nuclei. The polarization of the triple bonds in OTEs decreases with decreasing donor and acceptor strength. Scheme 15 demonstrates this effect by means of the $\Delta\delta$ shift differences in the series **65a–69a**. Oligomer series **65a–65d**, on the other hand, shows the weakening of the mutual interaction of the terminal partial dipole moments by increasing distance D–A.

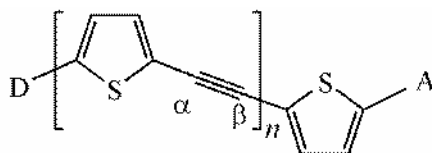

n	D	A	$\delta(\alpha)$	$\delta(\beta)$	$\Delta\delta$
65a	OCH_3	$CH=C(CN)_2$	95.7	84.1	11.6
66a	OCH_3	NO_2	92.9	83.2	9.7
67a	OCH_3	CHO	92.4	83.9	8.5
68a	OCH_3	H	86.9	83.9	3.0
69a	H	H	86.2	86.2	0

65	n	Donor side D: OCH_3			Acceptor side A: $CH=C(CN)_2$		
		$\delta(\alpha)$	$\delta(\beta)$	$\Delta\delta$	$\delta(\alpha)$	$\delta(\beta)$	$\Delta\delta$
a	1	95.7	84.1	11.6	95.7	84.1	11.6
b	2	89.7	83.5	6.2	92.0	86.4	5.6
c	3	88.9	83.6	5.3	93.4	88.4	5.0
d	4	88.7	83.6	5.1	93.4	88.2	5.2

Influence of the strength of donor D and acceptor A and of the D–A distance on the polarization of the OTE chain demonstrated by the ¹³C chemical shift differences $\Delta\delta$ of the sp -C atoms^{38,42} (δ values in ppm related to TMS as internal standard).

Scheme 15

OTE chains without terminal donor and/or acceptor groups exhibit δ (¹³C) values of the acetylenic carbon atoms which are very similar. The position of the pendants influences the δ values to a very small extent, as the following segments of a regio-irregular PTE chain proves (Scheme 16).¹⁷

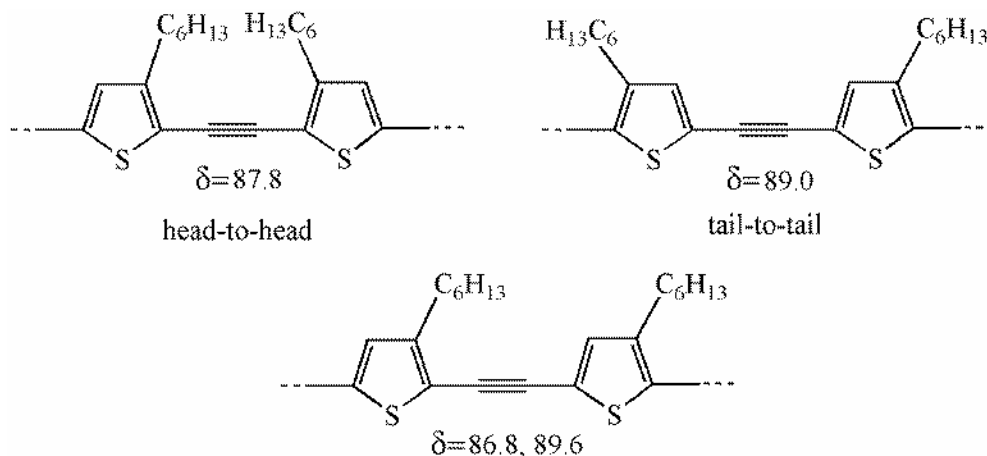

Influence of the side chains on the ^{13}C chemical shifts of sp-C atoms in certain segments of a regio-irregular PTE chain.

Scheme 16

The number of structural defects in PTEs is small. However, strong heating leads to a continuous decomposition. The intensity of the triple bond stretching vibration at 2180 cm^{-1} in the IR spectrum of poly(2,5-thienylene-ethynylene) is extremely lowered by heating.⁷ The decoupled spin density of the pristine polymer is $1.8 \cdot 10^{17}\text{ spin g}^{-1}$, but after heating this value raises to $2.7 \cdot 10^{18}\text{ spin g}^{-1}$. The structureless EPR signal at $g=2.0042$ is typical for the electron delocalisation.⁷

4. Electronic absorption and fluorescence

The long-wavelength absorption of OTEs corresponds to a $\pi\pi^*$ transition whose wavelength λ_{max} approaches to a limiting value λ_{∞} for increasing numbers n of repeat units:^{1f,k,x} Simple HMO theory would predict for conjugated oligomers a HOMO-LUMO gap which approaches to $E_{\infty}=0$ ($n \rightarrow \infty$). First and second order perturbation theory, however, predict a finite limiting value $E_{\infty} > 0$ and the corresponding $\lambda_{\infty} = hc E_{\infty}^{-1}$. The perturbation consists of different bond lengths in the chain. This statement is even valid for an ideal conjugation in a planar arrangement of the molecules. Torsions along the chain accelerate the convergence $\lambda_{\text{max}}(n) \rightarrow \lambda_{\infty}$ ($n \rightarrow \infty$). In “normal” series of conjugated oligomers, $\lambda_{\text{max}}(n)$ increases monotonously with increasing n . The effective conjugation length n_{ECL} of a conjugated chain is reached for $\lambda(n_{\text{ECL}}) = \lambda_{\infty} \pm 1\text{ nm}$ (the inaccuracy of a routine UV/Vis spectrum is about 1 nm). Some time ago, we suggested an empirical algorithm for the saturation phenomenon. The usual hyperbolic approximation, in which the excitation energy E is a function of the reciprocal number of repeat units n^{-1} , does not sufficiently represent the saturation phenomenon. It gives always too low E_{∞} values.^{1v}

Exponential functions for E or λ proved to be appropriate:⁵⁹

$$E(n) = E_{\infty} + (E_1 - E_{\infty})e^{-a(n-1)} \quad (4)$$

$$\lambda(n) = \lambda_{\infty} - (\lambda_{\infty} - \lambda_1)e^{-b(n-1)} \quad (5)$$

$$n_{\text{ECL}} = \ln(\lambda_{\infty} - \lambda_1) \cdot b^{-1} + 1 \quad (6)$$

λ_1, E_1 : absorption maximum of the monomer ($n=1$)

$\lambda_{\infty}, E_{\infty}$ a, b: optimized parameters (method of least squares)

Although ideally the $0 \rightarrow 0$ transitions should be used for λ , the λ_{max} values proved to be satisfactory in most cases. The effective conjugation length n_{ECL} indicates the minimum chain length for the lowest E value

(highest λ_{\max}), which is possible in the corresponding oligomer series. When λ_{\max} of a polymer does not reach λ_{∞} , the majority of the defect-free chain segments has an n value below n_{ECL} . Of course, the oligomer and polymer measurements have to be done in the same medium and at the same concentration – in so far as an aggregation tendency is present. As already mentioned above, PTEs have a very low number of structural defects, and the most usual defect is due to oxidative couplings, which lead to two conjugated triple bonds. Such a diyne segment does not significantly influence the absorption behavior.

Figure 1 depicts the measured λ_{\max} values of the OTE series **70**¹² and **71**^{15,16} and the curves $\lambda(n)$, which reflect the optimized functions of equation (5). The effective conjugation length n_{ECL} amounts to 11. The hexadecamer **71** ($n=16$) proves the saturation. Soluble compounds **70** with such high n values are not accessible.

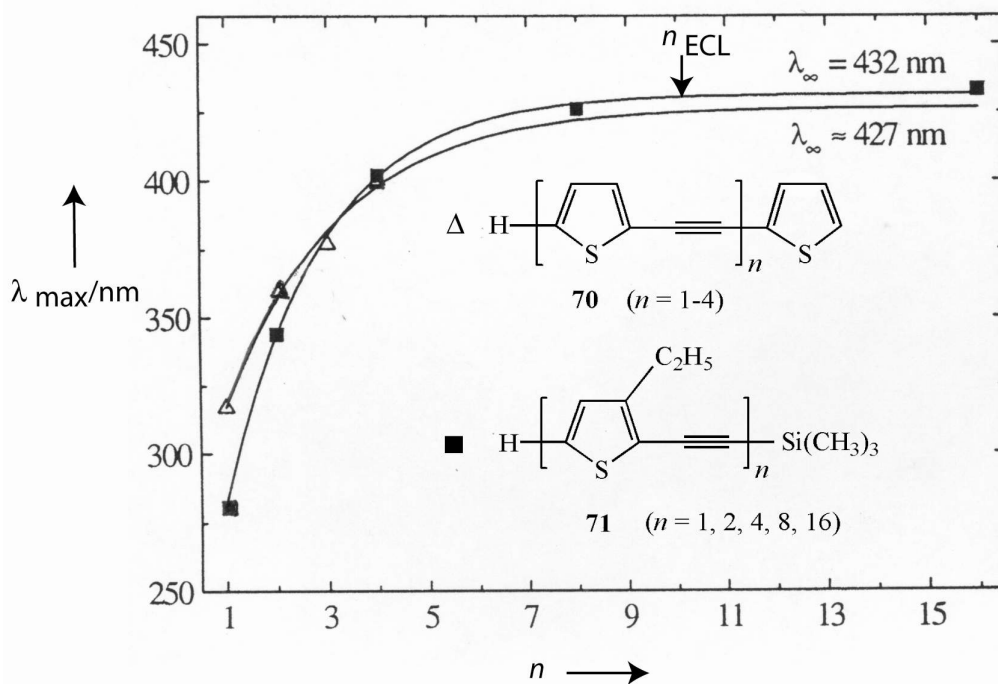

Absorption maxima of the OTE series **70** (in CHCl_3)¹² and **71** (in THF)^{15,16} and their exponential fit curves.⁵⁹

Figure 1

Recently Gierschner *et al.*⁶⁰ and Bednarz, Bäuerle *et al.*⁴⁰ proposed semi- to non-empirical equations for the long-wavelength band of conjugated oligomers. The Bednarz algorithm is based on Frenkel exciton models. For the OTE series **71**, equation (7) was used for the excitation energy E :

$$E = \frac{1}{2} (\omega_1 + \omega_2) - \left[(\omega_1 + \omega_2)^2 + 4J^2 \cos^2(\pi/N+1) \right]^{1/2} \quad (7)$$

$\omega_1 = 5.3$ eV excitation energy for the thiophene unit

$\omega_2 = 9.5$ eV excitation energy for the ethynylene unit

$J = 2.05$ eV nearest-neighbor exciton transfer matrix element

$N = 2n$ The repeat unit (2,5-thienyleneethynylene) is regarded as two different building blocks; therefore the number n is doubled.

Figure 2 demonstrates the good agreement between the measured and the calculated E values.⁴⁰ However, the extrapolation to the limiting value E_∞ ($n \rightarrow \infty$) leads to $\lambda_\infty = 444$ nm, which is higher than the extrapolated value shown in Figure 1.

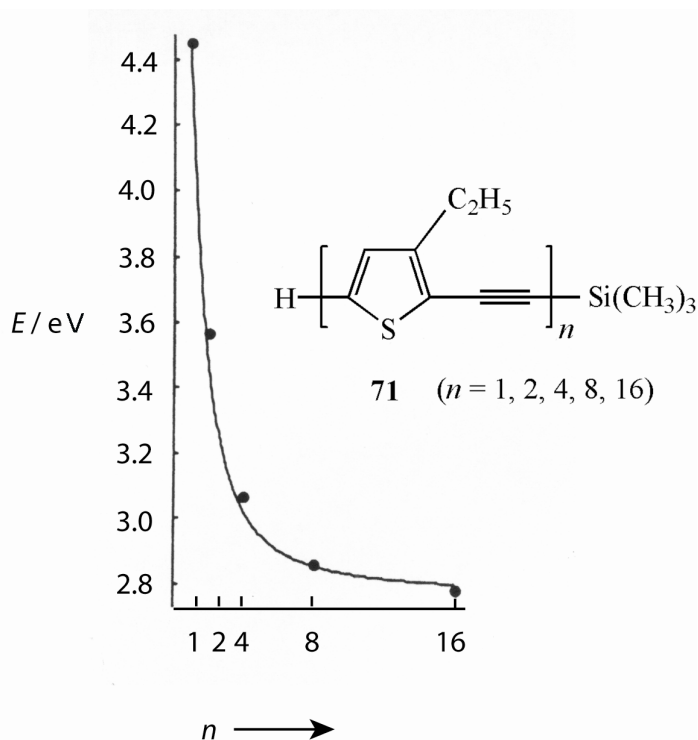

Excitation energies E for the long-wavelength $\pi \rightarrow \pi^*$ transition of the OTE series **71**. The dots indicate the measured values;^{15,16} the curve corresponds to equation (7).⁴⁰

Figure 2

Conjugated oligomers with terminal donor-acceptor substitution exhibit a more complex absorption behavior. The electronic excitation is combined with an intramolecular charge transfer (ICT), which causes a bathochromic shift. With increasing numbers n , that means with increasing distance between D and A, the ICT is reduced. The so-called charge transfer band loses more and more its CT character. Thus, increasing numbers n have to opposite effects: a bathochromic effect by extension of the conjugated chain and a hypsochromic effect by the decrease of the ICT. The crucial question is, which effect will predominate? Figure 3 shows the absorption behavior of different DAOTE series (**65–68**, **72**). An overall hypsochromic behavior is only observed for systems, which have a very strong push-pull effect. The ICT causes the decrease of the Coulomb repulsion integral, which has the major impact on the electron correlation. Consequently the excitation energy E decreases.^{1v}

The absorption intensity increases with increasing numbers n . This hyperchromic effect is valid although the ICT decreases the overlap density of the HOMO-LUMO transition. This is no contradiction because other orbitals are mixing in the long-wavelength transition. Its HOMO-LUMO portion decreases with increasing chain length.⁶¹

The extrapolation of λ_{\max} of the oligomer series **71** ($R^1 = C_2H_5$, $R^2 = H$) led to λ_∞ of 432 nm (Figure 1 and equation 5) and 444 nm (Figure 2 and equation 7), respectively. The corresponding polymer with $n > 16$ is not known. However, polymers **54**, **56** and **61** with $R^1 = C_6H_{13}$, $R^2 = H$ were studied.^{17,20,21} A λ_{\max} value of

440 nm was found for the head-to-tail system **54**. The other regio-regular chain **61** with a head-to-head-tail-to-tail sequence has its absorption maximum at 436 nm and the regio-random polymer **56** at 438 nm. All measurements were done in THF and reveal a small influence of the substitution pattern. Due to aggregation, thin films of the polymers **54**, **56** and **61** give broader bands with absorption maxima between 486 and 488 nm.⁶²

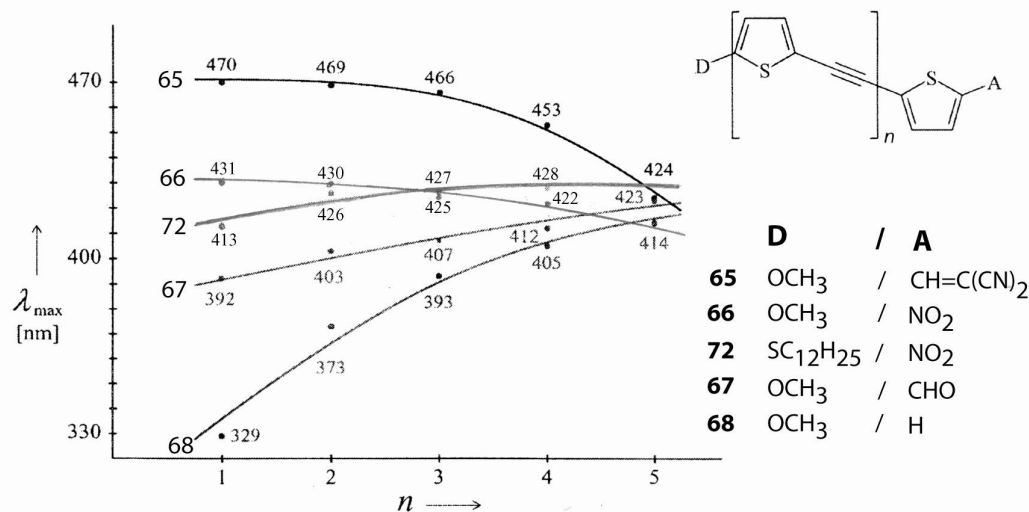

Absorption maxima of the DAOTE series **65–68**, **72** (measurement in CHCl₃) and exponential fit curves.¹²

Figure 3

The majority of OTE and PTE shows a relatively intense fluorescence. The reported quantum yields amount in solution to about 20%.^{20,28,63} Nevertheless, Ito, Otsubo *et al.*²⁹ found that intersystems crossing (ISC) is the major deactivation process of the excited singlet states S₁ (Figure 4).

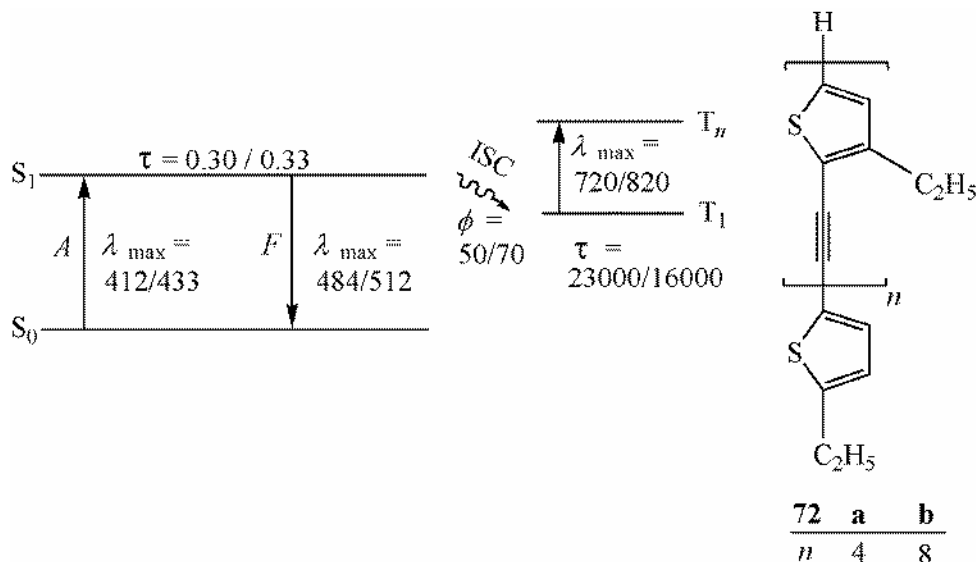

Energy diagram of the photophysical processes of **72a,b**: λ_{\max} in nm, average lifetime τ in ns, quantum yield ϕ in %. The first number corresponds to the tetramer ($n=4$), the second to the octamer ($n=8$).

Figure 4

The fluorescence emission has normally two maxima, whose λ_{\max} values display a bathochromic shift for increasing numbers n of repeat units. However, the differences $\lambda_{\max}(n+1) - \lambda_{\max}(n)$ in the fluorescence

spectra can be surprisingly small compared to the corresponding differences in the absorption spectra³⁶ (see for example Scheme 17).

When a separate chromophore, such as C₆₀, is attached by a saturated linker to the OTE, an additive absorption behaviour of the two chromophores can be assumed (for the first approximation). The fluorescence spectra however, can be strongly influenced by an energy and/or electron transfer.²⁵ Hindered conjugation or cross-conjugation between OTE chromophores or between an OTE and another chromophore may have similar consequences as the connection by a saturated linker.

5. Applications in materials science

The semiconductivity or photoconductivity of (doped) conjugated oligomers and polymers depends on the generation and mobility of charge carriers [radical cations and/or radical anions (polarons) and/or dications, dianions (bipolarons)]. The redox potentials provide valuable information in this context. Low-lying LUMOs and high-lying HOMOs are an important precondition for the formation of negative and positive, respectively, charge carriers. Increasing numbers of repeat units, n lead to lower oxidation potentials in cyclic voltametry and consequently to a higher electron donor ability.^{29,36} Breslow *et al.*³⁶ measured the oxidation potentials of the long OTE series **73**. Scheme 16 shows the saturation effect of the λ_{\max} values of absorption A and fluorescence F , but not yet for the first oxidation potentials E_{pa} . Obviously, the cations **73**⁺ have a much larger effective conjugation length n_{ELC} than the electroneutral molecules **73**.

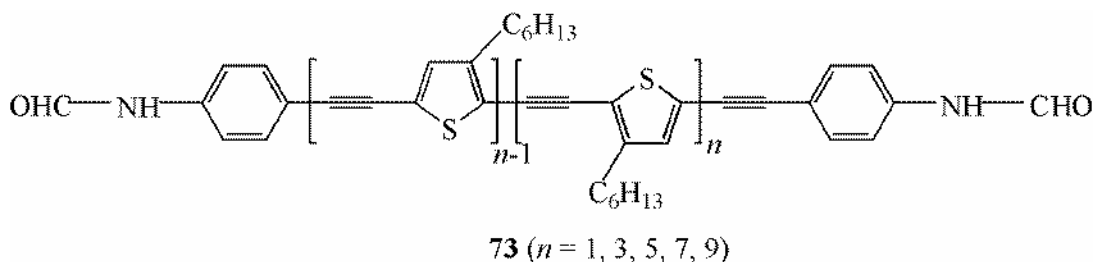

73	A	F	E_{pa}
n	λ_{\max} [nm]	λ_{\max} [nm]	[mV]
1	364	536	810
3	425	539	665
5	431	542	605
7	442	544	590
9	444	544	530

Absorption and fluorescence maxima of **73** (in CH₂Cl₂) and first oxidation potentials E_{pa} (CH₂Cl₂, 0.1 M (C₄H₉)₄NPF₆).

Scheme 17

Interesting electrical conductivities σ were reported for copolymers which contain 2,5-thienylene-ethynylene and TTF building blocks.¹⁸ Their σ values raise from 8.5×10^{-8} to 2.7×10^{-4} S cm⁻¹ on doping (oxidation) with iodine. The reductive range of OTEs and PTEs is less investigated.

Nonlinear optics (NLO) represent another field of interest in OTEs and PTEs.^{11,12,14,16} The first hyperpolarizability β is zero for compounds with a center of symmetry such as structure type **1b** (R¹=R²=E¹=E²=H). The related push-pull systems **16**, **18** and **20** should have high β values; they have still to be measured.

The second hyperpolarizability γ of the parent systems **70** was studied for $n=1-4$.¹² THG measurements revealed in this series an increase of the γ values from 6.3 via 55 and 150 to 230×10^{-35} esu. Samuel *et al.*¹⁶ investigated the long series **71** and found for $n=2, 4, 8,$ and 16 the γ values 4.7, 27.7, 126 and 315×10^{-35} esu. In principle, γ should increase with increasing numbers n without displaying a convergence to a limiting value; however, γn^{-1} or the slope of the curve $\gamma(n)$ should exhibit a saturation phenomenon.^{64,65} Although PTEs have been measured,^{11,14} this statement is difficult to verify, because the length of defectfree chain segments is not known. Moreover, from a practical point of view, the second and third harmonic generation (frequency doubling and tripling) and the corresponding hyperpolarizabilities β and γ should be related to the length of the chains or better to the molecular masses.

6. Conclusion and outlook

Owing to the Sonogashira-Hagihara reaction, as a versatile and plentiful sp-C–sp²-C cross-coupling method, oligo- and poly(2,5-thienylene-ethynylene)s [OTEs and PTEs] can be easily prepared (Section 2.). Alkyl groups as pendants on the thiophene rings guarantee a good solubility, which enables a detailed analytical and spectroscopic characterization (Section 3.) and facilitates the processing of these nanoparticles.

The convergence of certain properties for increasing chain length (increasing numbers of repeat units n) is demonstrated here for the absorption maxima $\lambda_{\max} \rightarrow \lambda_{\infty}$ ($n \rightarrow \infty$). This saturation phenomenon is important for optical, electrical and optoelectronic properties, which are determined by the HOMO-LUMO gap of the molecules or by the band gap in the solid state (Section 4.).

Apart from thienylene-ethynylene units as chromophores, fluorophores and electrophores, special building blocks can be attached to the OTE or PTE chains, so that an energy and/or charge transfer is possible. Special emphasis was given in this article to push-pull systems, in which an OTE linker connects an electron-donor group to an electron-acceptor.

The studies on applications of OTEs and PTEs (Section 5.) in materials science are still in the beginning. Thermal stability up to high temperatures and photostability in the range of the long-wavelength absorption promise a variety of further interesting applications as semiconductive, photoconductive, fluorescent, electroluminescent or nonlinear optical materials.

Finally, a detailed research on thienylene-ethynylenes should permit an interesting comparison to the related thienylene-vinylenes and thienylenes (oligo- and poly-thiophenes), which already have been studied more intensely. Recently a study on oligomers appeared which contain two 2,5-thienylene and one ethynylene building block in the repeat unit.⁶⁶

References and notes

1. Selected books and review articles: (a) Salaneck, W. R.; Lundström, I.; Ranby, B. R. *Conjugated Polymers and Related Materials*; Oxford University Press: Oxford, U.K., 1993. (b) Tour, J. M. *Chem. Rev.* **1996**, *96*, 537–553. (c) Moore, J. S. *Acc. Chem. Res.* **1997**, *30*, 402–413. (d) Roncali, J. *Chem. Rev.* **1997**, *97*, 173–205. (e) Kraft, A.; Grimsdale, A. C.; Holmes, A. B. *Angew. Chem.* **1998**, *110*, 416–443; *Angew. Chem. Int. Ed.* **1998**, *37*, 403–428. (f) *Electronic Materials: The Oligomer Approach*; Müllen, K.; Wegner, G., Eds.; Wiley-VCH: Weinheim, Germany, 1998. (g) Swager, T. M. *Acc. Chem. Res.* **1998**, *31*, 201–207. (h) Diederich, F.; Gobbi, L. *Top. Curr. Chem.* **1999**, *201*, 43–79. (i) Schwab, P. F. H.; Levin, M. D.; Michl, J. *Chem. Rev.* **1999**, *99*, 1863–1933. (j) Scherf, U. *Top. Curr. Chem.* **1999**, *201*, 163–222. (k) Martin, R. E.; Diederich, F. *Angew. Chem.* **1999**, *111*, 1440–

- 1469; *Angew. Chem., Int. Ed. Engl.* **1999**, *38*, 1350–1377. (l) Bunz, U. H. F. *Top. Curr. Chem.* **1999**, *201*, 131–161. (m) Bunz, U. H. F. *Chem. Rev.* **2000**, *100*, 1605–1644. (n) Segura, J. L.; Martin, N. J. *Mater. Chem.* **2000**, *10*, 2403–2435. (o) Hadziioannou, G.; van Hutten, P. F. *Semi-conductivity Polymers*; Wiley-VCH: Weinheim, Germany, 2000. (p) Roncali, J. *Acc. Chem. Res.* **2000**, *33*, 147–156. (q) Tour, J. M. *Acc. Chem. Res.* **2000**, *33*, 791–804. (r) Mishra, A.; Behera, R. K.; Behera, P. K.; Mishra, B. K.; Behera, G. B. *Chem. Rev.* **2000**, *100*, 1973–2011. (s) Bunz, U. H. F. *Acc. Chem. Res.* **2001**, *34*, 998–1010. (t) Szafert, S.; Gladysz, J. A. *Chem. Rev.* **2003**, *103*, 4175–4205. (u) Babudri, F.; Farinole, G. M.; Naso, F. *J. Mater. Chem.* **2004**, *14*, 11–34. (v) Meier, H. *Angew. Chem.* **2005**, *117*, 2536–2561; *Angew. Chem. Int. Ed.* **2005**, *44*, 2482–2506. (w) Grimsdale, A. C.; Müllen, K. *Angew. Chem.* **2005**, *117*, 5732–5772; *Angew. Chem. Int. Ed.* **2005**, *44*, 5592–5629. (x) Meier, H. In: *Carbon-Rich Compounds*; Haley, M. M.; Tykwinski, R. R., Eds.; Wiley-VCH: Weinheim, Germany, 2006; pp. 476–528. (y) Müllen, K.; Scherf, U. *Organic Light-Emitting Devices*; Wiley-VCH: Weinheim, Germany, 2006. (z) Meier, H.; Mühling, B. *Arkivoc*, **2009**, *ix*, 57–69.
2. Carpita, A.; Lessi, A.; Rossi, R. *Synthesis* **1984**, 571–572.
 3. Rossi, R.; Carpita, A.; Lezzi, A. *Tetrahedron* **1984**, *40*, 2773–2780.
 4. Trumbo, D. L.; Marvel, C. S. *J. Polym. Sci., Part A: Polym. Chem. Ed.* **1986**, *24*, 2231–2238.
 5. Cernia, E.; D'Ilario, L.; Ortaggi, G.; Scarsella, M.; Scialis, R.; Sleiter, G. *Gazz. Chim. Ital.* **1989**, *119*, 309–310.
 6. (a) D'Auria, M.; Mico, A.; D'Onofrio, F.; Piancatelli, G. *Gazz. Chim. Ital.* **1989**, *119*, 201–202. See also: (b) D'Auria, M. *Targets in Heterocyclic Systems*; Attanasi, O. A.; Spinelli, D., Eds.; Società Chimica Italiana: Rome, 1997; Vol. 1, pp. 277–302.
 7. Chimenti, F.; D'Ilario, L.; Ettore, A.; Muraglia, E.; Ortaggi, G.; Sleiter, G. *J. Mater. Sci. Lett.* **1992**, *11*, 1532–1533.
 8. Tormos, G. V.; Nugara, P. N.; Lakshmikantham, M. V.; Cava, M. P. *Synth. Met.* **1993**, *53*, 271–281.
 9. Tour, J. M.; Schumm, J. S. *Polymer Preprints* **1993**, *34*(2), 368–369.
 10. Swanson, L. S.; Lane, P. A.; Shinar, J.; Pang, Y.; Barton, T. J. *Synth. Met.* **1993**, *55*, 293–298.
 11. Ooba, N.; Tomaru, S.; Kurihara, T.; Kaino, T.; Yamada, W.; Takagi, M.; Yamamoto, T. *Jpn. J. Appl. Phys.* **1995**, *34*, 3139–3149.
 12. Geisler, T.; Petersen, J. C.; Bjoernholm, T.; Fischer, E.; Larsen, J.; Dehn, C.; Brédas, J.-L.; Tormos, G. V.; Nugara, P. N.; Cava, M. P.; Metzger, R. M. *J. Phys. Chem.* **1994**, *98*, 10102–10111.
 13. Pearson, D. L.; Schumm, J. S.; Tour, J. M. *Macromolecules* **1994**, *27*, 2348–2350.
 14. Yamamoto, T.; Yamada, W.; Takagi, M.; Kizu, K.; Maruyama, T.; Orba, N.; Tomaru, S.; Kurihara, T.; Kaino, T.; Kubota, K. *Macromolecules* **1994**, *27*, 6620–6626.
 15. Wu, R.; Schumm, J. S.; Pearson, D. L.; Tour, J. M. *J. Org. Chem.* **1996**, *61*, 6906–6921.
 16. Samuel, I. D. W.; Ledoux, I.; Delporte, C.; Pearson, D. L.; Tour, J. M. *Chem. Mater.* **1996**, *8*, 819–821.
 17. Pang, Y.; Wang, Z. C.; Barton, T. J. *Polym. Prepr.* **1996**, *37*, 333–334.
 18. Yamamoto, T.; Shimizu, T. *J. Mater. Chem.* **1997**, *7*, 1967–1968.
 19. Hayashi, H.; Yamamoto, T. *Macromolecules* **1997**, *30*, 330–332.
 20. Li, J.; Pang, Y. *Macromolecules* **1997**, *30*, 7487–7492.
 21. Li, J.; Pang, Y. *Polym. Prepr.* **1997**, *38*, 213–214.
 22. Zimmer, H.; Sudsuansri, K.; Maik, H. B.; Ziegler, B. *Phosphorus, Sulfur, Silicon Rel. Elem.* **1997**, *122*, 269–286.
 23. Pearson, D. L.; Tour, J. M. *J. Org. Chem.* **1997**, *62*, 1376–1387.
 24. Pearson, D. L.; Jones, L. II; Schumm, J. S.; Tour, J. M. *Synth. Met.* **1997**, *84*, 303–306.
 25. Obara, Y.; Takimiya, K.; Aso, Y.; Otsubo, T. *Tetrahedron Lett.* **2001**, *42*, 6877–6882.
 26. Polzonetti, G.; Carravetta, V.; Ferri, A.; Altamura, P.; Alagia, M.; Richter, R.; Russo, M. V. *Chem. Phys. Lett.* **2001**, *340*, 449–457.
 27. Li, J.; Liao, L.; Pang, Y. *Tetrahedron Lett.* **2002**, *43*, 391–394.
 28. Pappenfus, T. M.; Mann, K. R. *Org. Lett.* **2002**, *4*, 3043–3046.
 29. Fujitsuka, M.; Makinoshima, T.; Ito, O.; Obara, Y.; Aso, Y.; Otsubo, T. *J. Phys. Chem. B* **2003**, *107*, 739–746.
 30. De Nicola, A.; Ringenbach, C.; Ziessel, R. *Tetrahedron Lett.* **2003**, *44*, 183–188.

31. Ringenbach, C.; De Nicola, A.; Ziesel, R. *J. Org. Chem.* **2003**, *68*, 4708–4719.
32. Hughes, G.; Kreher, D.; Wang, C.; Batsanov, A. S.; Bryce, M. R. *Org. Biomol. Chem.* **2004**, *2*, 3363–3367.
33. Tanifuji, N.; Irie, M.; Matsuda, K. *J. Am. Chem. Soc.* **2005**, *127*, 13344–13353.
34. Wang, J.-L.; Luo, J.; Liu, L.-H.; Zhou, Q.-F.; Ma, Y.; Pei, J. *Org. Lett.* **2006**, *8*, 2281–2284.
35. Pei, J.; Zhang, W.-Y.; Mao, J.; Zhou, X.-H. *Tetrahedron Lett.* **2006**, *47*, 1551–1554.
36. Tam, I. W.; Yan, J.; Breslow, R. *Org. Lett.* **2006**, *8*, 183–185.
37. Nakao, K.; Nishimura, M.; Tamachi, T.; Kuwatani, Y.; Miyasaka, H.; Nishinaga, T.; Iyoda, M. *J. Am. Chem. Soc.* **2006**, *128*, 16740–16747.
38. Meier, H.; Mühling, B.; Oehlhof, A.; Theisinger, S.; Kirsten, E. *Eur. J. Org. Chem.* **2006**, 405–413.
39. Mühling, B.; Theisinger, S.; Meier, H. *Synthesis* **2006**, 1009–1015.
40. Bednarz, M.; Reineker, P.; Mena-Osteritz, E.; Bäurle, P. *Chem. Phys.* **2007**, *342*, 191–200.
41. Matthews, J. R.; Goldoni, F.; Kooijman, H.; Spek, A. L.; Schenning, A. P. H. J.; Meijer, E. W. *Macromol. Rap. Commun.* **2007**, *28*, 1809–1815.
42. Meier, H.; Mühling, B.; Gerold, J.; Jacob, D.; Oehlhof, A. *Eur. J. Org. Chem.* **2007**, 625–631.
43. Ng, S.-C.; Ong, T.-T.; Chan, H. S. O. *J. Mater. Chem.* **1998**, *8*, 2663–2669.
44. McKellar, B. R.; Feld, W. A. *Polym. Prepr.* **1993**, *34*(2), 380–381.
45. Kijima, M.; Shirakawa, H. (Nisshin Spinning Co. Ltd., Japan) *Jpn. Kokai Tokkyo Koho JP 2001172369* (2001); *Chem. Abstr.* **2001**, *135*, 61784.
46. Sonogashira, K.; Tohda, Y.; Hagihara, N. *Tetrahedron Lett.* **1975**, *16*, 4467–4470.
47. Takahashi, S.; Kuroyama, Y.; Sonogashira, K.; Hagihara, N. *Synthesis* **1980**, 627–630.
48. Stephens, R. D.; Castro, C. E. *J. Org. Chem.* **1963**, *28*, 3313–3315.
49. One or two coupled catalytic circles were suggested.^{50–52} Depending on electron-poor or electron-rich alkynes, a change of mechanisms seems to be reasonable.⁵² A major problem consists in the deprotonation of terminal alkynes by *tert.* amines as weak bases. In order to overcome this difficulty, the primary formation of Pd or Cu π -complexes was postulated. However, neither their intermediate formation nor their deprotonation by *tert.* amines was really proved.
50. Chinchilla, R.; Nájera, C. *Chem. Rev.* **2007**, *107*, 874–922.
51. Doucet, H.; Hierso, J.-C. *Angew. Chem.* **2007**, *119*, 850–888; *Angew. Chem. Int. Ed.* **2007**, *46*, 834–871.
52. Ljungdahl, T.; Bennur, T.; Dallas, A.; Emtenäs, H.; Märtensson, J. *Organometallics* **2008**, *27*, 2490–2498.
53. Therefore dialkynes as oxidation products are often minor by-products.
54. CuI as co-catalyst can be omitted for highly reactive compounds R¹-I.
55. Highly polar triple bonds can add primary or secondary amines under these conditions. In such cases, only tertiary amines can be used.³⁸
56. Originally the -C(CH₃)₂ OH group served as protecting group.^{2,3} Nowadays this group is seldom used.^{30,31}
57. In difficult cases Si(CH₃)₃ and additionally Si[CH(CH₃)₂] protecting groups can be used, because a selective deprotection of Si(CH₃)₃ with K₂CO₃ is possible. Fluoride as base cleaves both silyl groups.
58. McCaughey, B.; Costello, C.; Wang, D.; Hampsey, J. E.; Yang, Z.; Li, C.; Brinker, J.; Lu, Y. *Adv. Mater.* **2003**, *15*, 1266–1269.
59. Meier, H.; Stalmach, U.; Kolshorn, H. *Acta Polym.* **1997**, *48*, 379–384.
60. Gierschner, J.; Cornil, J.; Egelhaaf, H.-J. *Adv. Mater.* **2007**, *19*, 173–191.
61. See, for example: Meier, H.; Gerold, J.; Kolshorn, H.; Baumann, W.; Beetz, M. *Angew. Chem.* **2002**, *114*, 302–306; *Angew. Chem. Int. Ed.* **2002**, *41*, 292–295.
62. The preparation of PTEs can have a strong impact on the λ_{\max} values. See for example Ref.¹⁴
63. Push-pull OTEs or very short OTEs can have $\phi_F \leq 0.1\%$.
64. Koynov, K.; Bahtiar, A.; Bubeck, C.; Mühling, B.; Meier, H. *J. Phys. Chem. B* **2005**, *109*, 10184–10188.
65. Meier, H.; Ickenroth, D.; Stalmach, U.; Koynov, K.; Bahtiar, A.; Bubeck, C. *Eur. J. Org. Chem.* **2001**, 4431–4443.
66. Bäuerle, P.; Cremer, J. *Chem. Mater.* **2008**, *20*, 2696–2703.

CHEMOENZYMATIC SYNTHESIS OF OPTICALLY ACTIVE PYRIDINE DERIVATIVES

Vicente Gotor-Fernández, Eduardo Busto and Vicente Gotor

Departamento de Química Orgánica e Inorgánica and Instituto Universitario de Biotecnología de Asturias. Universidad de Oviedo, E-33006-Oviedo (Asturias), Spain (e-mail: vgs@uniovi.es)

Abstract. *Biocatalysis offers a clean, straightforward and ecological manner to perform asymmetric transformations in mild reaction conditions. This review covers the preparation of pyridine derivatives using enzymes for the introduction of chirality in the desired molecule or alternatively in an adequate building block. For this aim, lipases, oxidoreductases and lyases have traditionally been used allowing generally the recovery of the final products in excellent yields and enantiomeric excesses.*

Contents

1. Introduction
 2. Use of hydrolases
 - 2.1. Lipase-catalyzed kinetic and dynamic kinetic resolution of alcohols or esters
 - 2.2. Proteases in the resolution of esters through hydrolytic processes
 - 2.3. Asymmetrization or desymmetrization of diols or diacetates using lipases
 - 2.4. Kinetic resolution of racemic amines using lipases in organic solvents
 - 2.5. Classical kinetic resolutions using epoxide hydrolases
 3. Use of oxidoreductases
 - 3.1. Alcohol dehydrogenases
 - 3.1.1. Bioreductions
 - 3.1.2. Biooxidations
 - 3.1.3. Deracemizations combining biooxidation and bioreduction processes
 - 3.2. Bioxygenations using oxygenases
 4. Use of lyases
 - 4.1. Synthesis of chiral cyanohydrins using oxynitrilases
 - 4.2. Aldolases for the production of chiral pyridines
 5. Concluding remarks
- Acknowledgments
References

1. Introduction

Pyridine derivatives are a class of organic compounds of the aromatic heterocyclic series characterized by a six-membered ring structure composed of five carbons atoms and one nitrogen atom, being the own pyridine the simplest member of the pyridine family, substrate with molecular formula C_5H_5N (Py, Figure 1). This water miscible organic compound possesses a distinctive fish-like odour and it has important applications as can be used as a polar solvent, as donor ligand for organometallic complexes, form part of

many important products such as nicotinamides or 4-(*N,N*-dimethylamino)pyridine (DMAP), but also being a useful precursors of agrochemicals or pharmaceuticals.

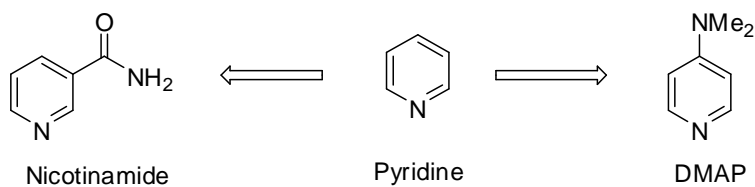

Figure 1. Significant molecules containing the pyridine ring.

This cyclic compound possesses different chemical behaviours due to its six-membered ring: for example, it can act as a base because of its nitrogen atom, being possible protonation, acylation, alkylation and *N*-oxidation reactions, or can behave as an aromatic reactant undergoing nucleophilic substitutions. It is specially important its role in the synthesis of a wide range of important goods as herbicides, insecticides, food flavourings, dyes, paints, adhesives, pharmaceuticals or explosives; for that reason the preparation of pyridine derivatives has constituted a big challenge for organic chemist. Thus, there are many strategies that lead to the access of pyridine derivatives being biotransformation effective tools for the synthesis of optically active compounds.

In the last decades, biocatalysis has emerged as a very useful methodology for the synthesis of chiral and highly interesting intermediates or final products for the industrial sector, biotransformations being carried out at volumes that range from a gram scale in the pharmaceutical industry to multi-thousand ton scales in the manufacturing of commodity chemicals. The main advantages of these biocatalytic processes are based on their low-cost and the mild and environmentally friendly reaction conditions required. Over the past few years, interesting processes have appeared to catalyze single-step transformations using normally hydrolases, oxidoreductases or lyases as biocatalysts.

The combination of biocatalysis and chemical catalysis in multi-step syntheses is growing in these days, especially in the industrial sector due to the increasing demand of enantiomerically pure goods, reducing waste streams and improving overall synthetic yields. Normally, in these tandem procedures, first the preparation of the intermediate takes place by a selected biotransformation to yield later the target compound by conventional organic chemical methods.

In this review we have focused our efforts in the compilation of a vast number of interesting examples for the production of optically active pyridine derivatives, trying to explain later their potential use or applications in different fields such as organic catalysis or the preparation of chiral drugs. Thus, biocatalytic methods that involve the use of lipases and alcohol dehydrogenases represent the mostly employed alternatives due to the high stereoselectivity usually showed by these types of enzymes.

2. Use of hydrolases

Hydrolytic transformations are traditionally the most common enzymatic processes involving ester and amide bonds using proteases, lipases or esterases. Lipases are part of the hydrolases group catalyzing mainly hydrolysis and esterification procedures, although lipase-mediated reactions of esters with nucleophiles such as ammonia or amines are also well known. These enzymes present high activity values in aqueous medium but also in organic solvents, acting in a chemo-, regio- or enantioselective way under mild reaction conditions.

2.1. Lipase-catalyzed kinetic resolution of alcohols or esters

The most traditional examples using lipases for the synthesis of optically pyridine derivatives have been described for the enzymatic kinetic resolution of pyridylethanols or the corresponding ester derivatives.¹ Thus, acetylation procedures of alcohols or the enantioselective hydrolysis of the corresponding esters have been extensively explored looking for adequate enzyme activities (Scheme 1). For that reason, there are many biocatalysts that have been employed such as *Rhizopus nigricans*,^{1a} Baker's yeast,^{1b} Pig liver esterase (PLE),^{1c} *Pseudomonas cepacea* lipase (PSL),^{1d,1e} *Candida antarctica* lipase B,^{1f} *Candida rugosa* lipase (CRL)^{1g} or feruloyl esterase from *Humicola insolens*.^{1h} The applicability of these compounds has been proved using some of these chiral precursors in the synthesis of NMDA glycine-site agonist.²

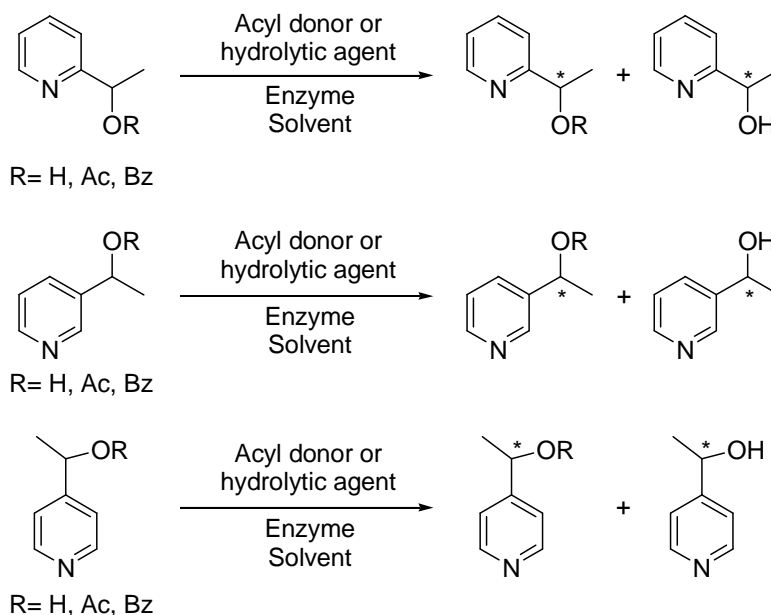

Scheme 1. Enzymatic kinetic resolution of pyridylethanols through acylation or hydrolysis procedures.

Selection of an appropriate acyl donor is an important parameter for a good biotransformation; in this manner, vinyl acetate and isopropenyl acetate are the most useful acylating reagents for the enzymatic kinetic resolution of alcohol derivatives. On the other hand, water or phosphate buffer solutions are the most common hydrolytic agents. Dry and at the same time low polar solvents are generally required for lipase-catalyzed resolutions such as hexane, diethyl ether (Et₂O), *tert*-butylmethyl ether (TBME) or diisopropyl ether (iPr₂O) in order to avoid the competitive hydrolysis reactions. Sometimes additives can improve the enzyme catalytic properties and, for example, an increased enantioselectivity and an acceleration of the lipase-acetylation of 2-, 3- and 4-pyridylethanols have been observed using an imidazolium PEG-alkyl sulfate ionic liquid.³

Employing an acetylation procedure, PSL catalyzed efficiently the acetylation of 3-pyridylethanol for the total synthesis of indole alkaloids (–)-Tubifoline, (–)-Tubifolidine and (–)-19,20-dihydroakuammicine using vinyl acetate as acyl donor and TBME as solvent. After 40 h the acetate was recovered in 48% yield and the alcohol in 47% yield, both in 96% *ee*.⁴

A short stereoselective synthesis of (+)- α -conhydrine, a class of alkaloid which can be isolated from the poisonous plant *Conium maculatum*, was achieved based on the enzymatic kinetic resolution of 2-(1-hydroxypropyl)pyridine with PSL, being obtained the (*R*)-acetate (45% yield and 98% *ee*) and the

remaining (*S*)-alcohol (45% yield and 96% *ee*) after 47.5 h at 30 °C using vinyl acetate as acyl donor and solvent (Scheme 2).⁵

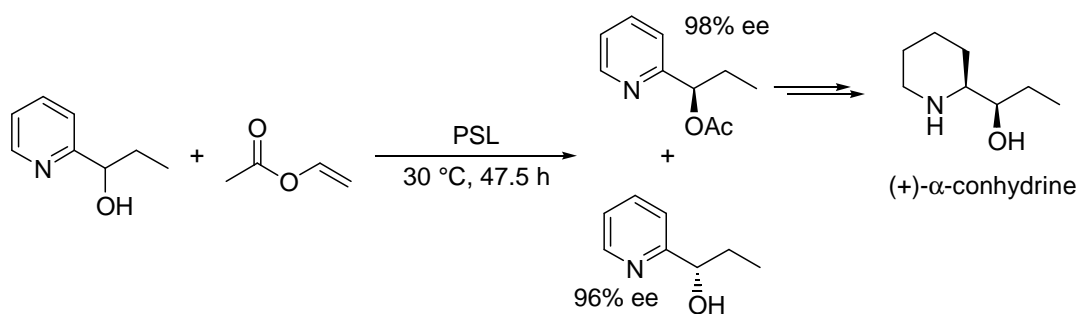

Scheme 2. Lipase-mediated kinetic resolution of 2-(1-hydroxypropyl)pyridine for the stereoselective synthesis of (+)- α -conhydrine.

4-(Dimethylamino)pyridine (DMAP) is the most common nucleophilic catalyst for acyl transfer chemical reactions and some efforts have been done for the production of derivatives in enantiopure form to later study their applications in asymmetric catalysis. Thus, 4-chlorosubstituted racemic precursors have been chemically prepared and the lipase-catalyzed acetylation procedures have been studied, being obtained 4-chloro-2-(1-hydroxyalkyl)pyridines and 4-chloro-2-(1-hydroxybenzyl)pyridine in moderate to excellent enantiomeric excesses using PSL or CAL-B as biocatalysts and vinyl acetate as acyl donor (Scheme 3).⁶ Chlorinated derivatives present two great advantages: a) they present a great versatility in organic synthesis because this atom presents a remarkable reactivity in substitution reactions; b) these substrates are enzymatically acetylated with higher enantioselectivities than the corresponding 4-(*N,N*-dimethylamino) analogues, maybe because they fit better into the enzyme active site.

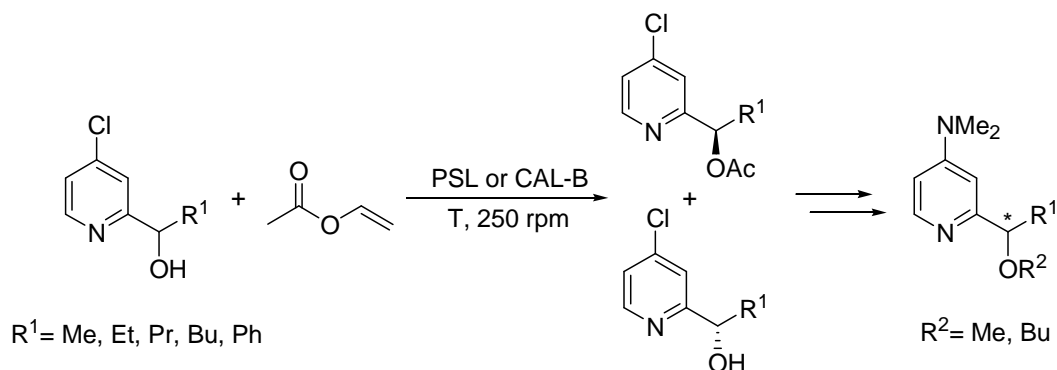

Scheme 3. Enzymatic kinetic resolution of 4-chloro-2-(1-hydroxyalkyl)pyridines and 4-chloro-2-(1-hydroxybenzyl)pyridine using lipases.

Alternatively, 4-chloro-3-(1-hydroxyalkyl)pyridines have been tested with a panel of lipases finding the best results with CAL-B when 4-chloro-3-(1-hydroxyethyl)pyridine was examined using vinyl acetate as acyl donor and solvent; however, a dramatically reactivity fall was observed using pyridines with bulkier substituents (Scheme 4).⁷

Some interesting applications of substituted pyridylethanols have been described as the synthesis of (–)-Mytragynine, an analgesic indole alkaloid, starting from the PSL-catalyzed resolution of 1-(6-chloro-

pyridin-3-yl)ethyl acetate by a hydrolytic procedure, which allowed the recovery of both acetate and alcohol in enantiopure form using a phosphate buffer of pH 7.0 (Scheme 5).⁸

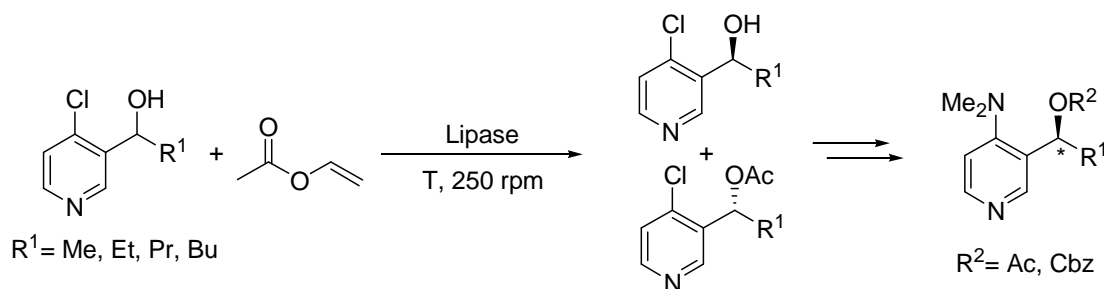

Scheme 4. Kinetic resolution of 4-chloro-3-(1-hydroxyalkyl)pyridines using lipases.

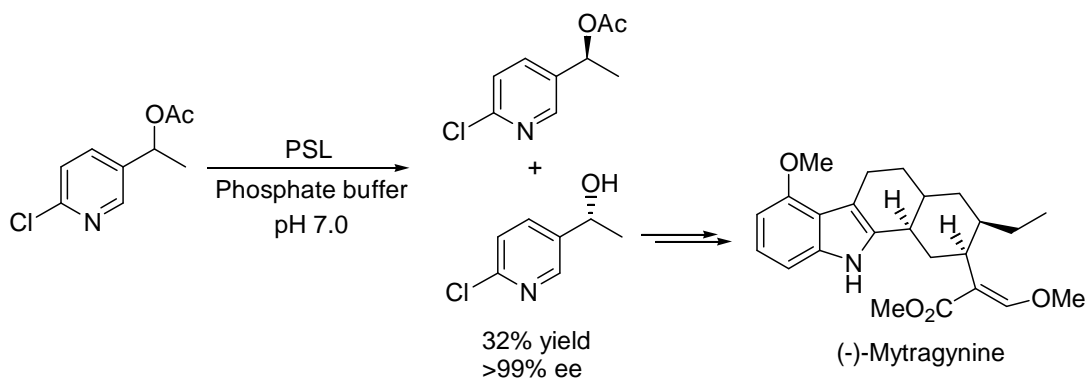

Scheme 5. Kinetic resolution of 1-(6-chloropyridin-3-yl)ethyl acetate for the total synthesis of (-)-Mytragynine.

Using a similar approach, pyridine derivatives such as bypyridylethanols have been efficiently resolved by using CAL-B with vinyl acetate as acyl donor in diisopropyl ether ($i\text{Pr}_2\text{O}$) as solvent (Scheme 6).⁹ The same authors extended later this study to other interesting 6-substituted pyridines and also 1-pyridin-2-ylalkan-1-ols or isoquinoline derivatives.¹⁰ In all cases, the (*R*)-acetates and the (*S*)-alcohols were recovered after flash chromatography using silica gel, being the enzymatic processes carried out at room temperature or 60 °C depending on the substrate reactivity.

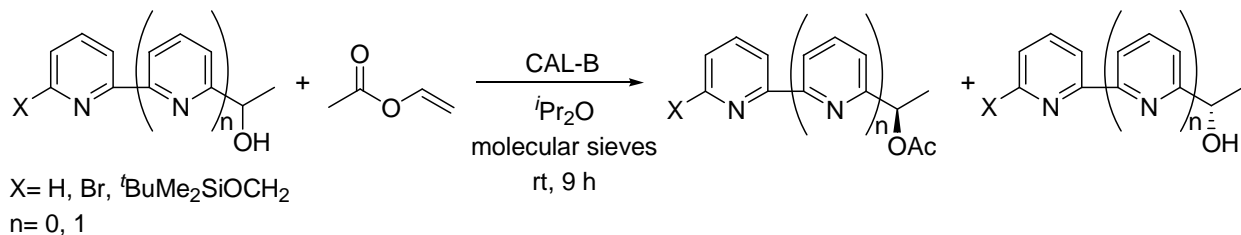

Scheme 6. Kinetic enzymatic resolution of oligopyridines.

Scilimati and co-workers described the enzymatic kinetic resolution of racemic 2-chloro-1-(pyridin-3-yl)ethanol. For that purpose, a set of hydrolases were exhaustively studied finding the best results for CAL-B when vinyl acetate was used as acyl donor, leading in hexane to the (*R*)-alcohol in enantiopure form that was later converted into (*R*)-1-(pyridin-3-yl)-2-amino-ethanol, a useful intermediate for the preparation of β_3 -adrenergic receptor agonists (Scheme 7).¹¹

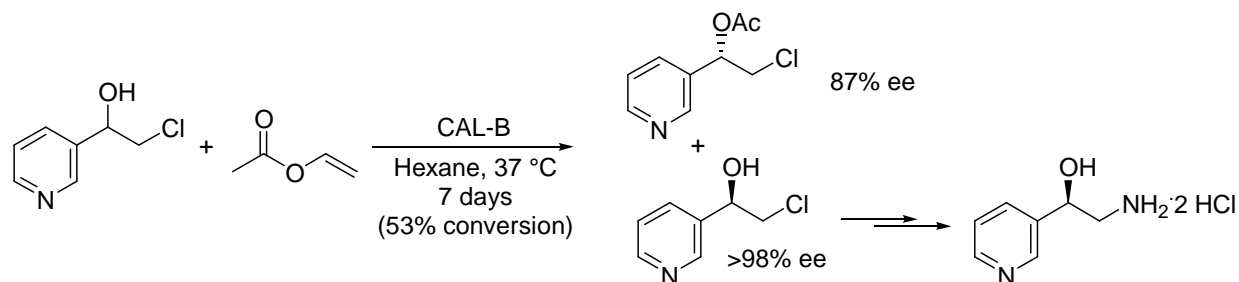

Scheme 7. Lipase-mediated resolution of racemic 2-chloro-1-(pyridin-3-yl)ethanol.

The kinetic resolution of racemic isoquinoline derivatives have been also successfully achieved using lipases such as CAL-B, PSL or PPL for the enzymatic acylation of alcohols using vinyl acetate at the same time as acyl donor and solvent, or the hydrolysis of acetates in phosphate buffer (Scheme 8). For the acetylation reactions, the (*S*)-alcohols and the (*R*)-acetates were generally obtained in excellent enantiomeric excesses, meanwhile the complementary optically active (*R*)-alcohols and the (*S*)-acetates were recovered in the hydrolysis reactions.¹²

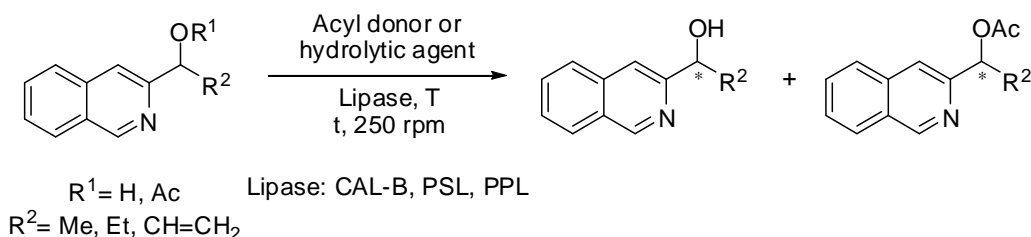

Scheme 8. Kinetic resolution of isoquinoline derivatives by acetylation or hydrolytic procedures.

Enantiomerically pure 8-substituted 5,6,7,8-tetrahydroquinolines have been chemoenzymatically prepared starting from the lipase-catalyzed kinetic acetylation of racemic 5,6,7,8-tetrahydroquinolin-8-ol using CAL-B and isopropenyl acetate as acyl donor in *i*-Pr₂O as solvent at 60 °C (Scheme 9), obtaining both the (*R*)-acetate and the (*S*)-alcohol in enantiomerically pure form after 30 h of reaction.¹³

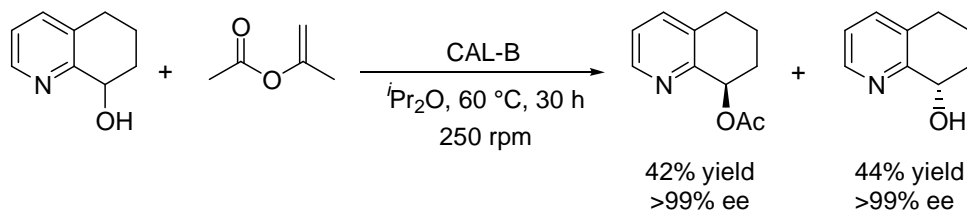

Scheme 9. Enzymatic kinetic resolution of 5,6,7,8-tetrahydroquinolin-8-ol.

PSL has catalyzed the enantioselective acetylation of α -hydroxybenzylpyridines obtaining the corresponding 2-, 3- and 4-pyridine derivatives in moderate enantiomeric excesses using vinyl acetate as acyl donor and TBME as solvent, caused for the presence of similar and bulky substituents at both sides of the stereogenic centre (Scheme 10).¹⁴ Years later the corresponding racemic acetates were subjected to asymmetric hydrolysis using cell cultures of *Nicotiana tabacum* leading to the alcohols and acetates with moderate to good enantiomeric excesses for the 3- and 4-substituted derivatives, meanwhile the 2-substituted acetate was hydrolyzed with none enantioselectivity.¹⁵ In a similar approach, optically active 2- and

4- α -(*p*-chlorophenyl)pyridylmethanols were investigated using an asymmetric hydrolysis approach leading to the corresponding alcohols and acetates in low enantiomeric excesses using a set of biocatalysts, finding the best results with lipase AY and the 4-substituted compound.¹⁶

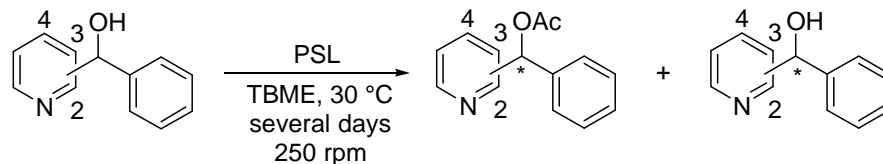

Scheme 10. Enzymatic acetylation of α -hydroxybenzylpyridines catalyzed by PSL.

Faber and co-workers described the lipase mediated kinetic resolution of α -pyridoin using vinyl acetate as acyl donor, THF as solvent and lipase Amano TL as biocatalyst, obtaining the (*R*)-alcohol in >99% *ee* and 36% yield after 24 hours at 30 °C (Scheme 11).¹⁷

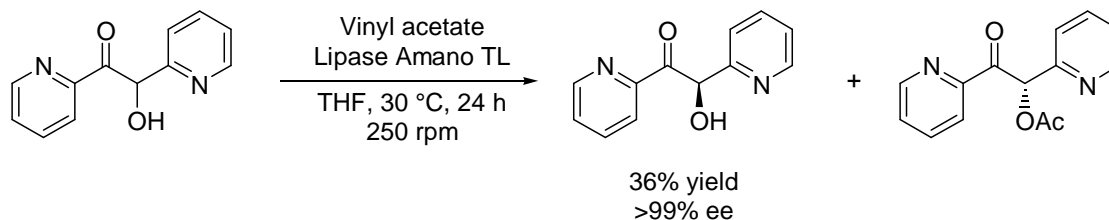

Scheme 11. Enzymatic stereoselective acetylation of α -pyridoin.

Chiral hydroxy sulfides are important precursors in the synthesis of chiral oxiranes, thiiranes, tetrahydrofurans, spiroketalpheromones and acetoxyazetidinones, and their enzymatic resolution was studied using *Humicola lanuginosa* lipase (HLL) with vinyl acetate as acyl donor and solvent obtaining the (*R*)-acetates with very high enantiomeric excesses and the (*S*)-alcohols with low selectivities (Scheme 12).¹⁸

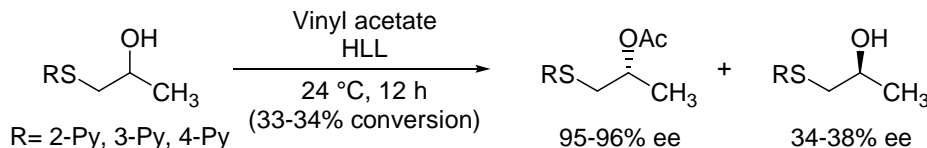

Scheme 12. Enzymatic kinetic resolution of β -hydroxy sulfides catalyzed by HLL.

Henegar and co-workers described the enzymatic acetylation of a diol, which finally was demonstrated to be an ideal precursor for the synthesis of Irinotecan and other Camptothecin analogues that have potent antitumoral activities. The kinetic resolution was based on the use of PSL immobilized on Celite[®] as enzyme and isopropenyl acetate as the best acyl donor (Scheme 13).¹⁹ A 60% conversion was reached, obtaining the corresponding (*S*)-diol in >99% *ee*. Further studies looking for more adequate acyl donors were performed as the use of anhydrides but lower enantioselectivities were founded.

An enantioselective esterification of (–)-*anti*-3-[2-(5-benzyloxypyridyl)]-2-methyl-1,3-propanediol using lipase Amano P in the presence of vinyl acetate and ⁱPr₂O provided the enantiomerically pure (2*S*,3*S*)-diol, which was later converted into an interesting precursor for the synthesis of Nikkomycin Z that is a peptidyl nucleoside inhibitor of chitin synthetase with antifungal, acaricidal and antibacterial activity (Scheme 14).²⁰

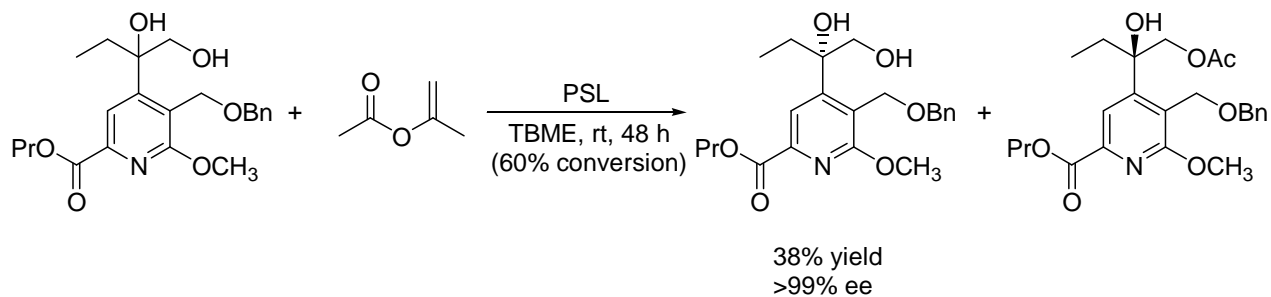

Scheme 13. Kinetic resolution of an adequate building block for the synthesis of Irinotecan.

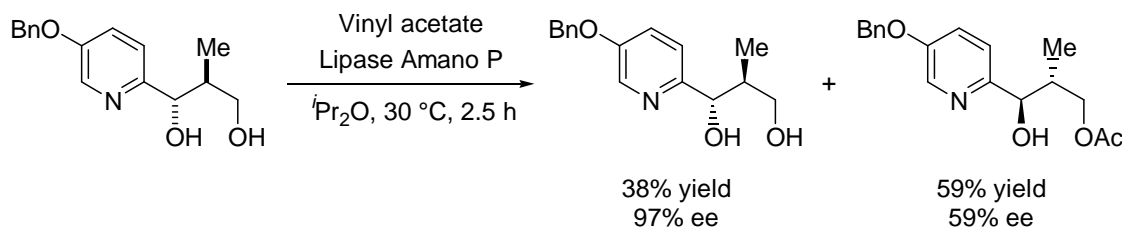

Scheme 14. Enantioselective acetylation of (S)-anti-3-[2-(5-benzyloxy)pyridyl]-2-methyl-1,3-propanediol.

Although enzymatic resolutions are very efficient processes, they possess an inherent limitation based on the fact that just 50% conversion of enantiomerically pure compounds can be isolated. For that reason, different strategies have appeared in the literature during recent years trying to avoid this limitation. The use of lipases in combination with metal complexes, responsible of racemization of the unreacted enantiomer, allows the access to enantiopure compounds with isolated yields theoretically of 100%. These protocols are called dynamic kinetic resolutions (DKR) and recently Bäckvall and co-workers have described the DKR of 1-(4-pyridyl)ethanol using a ruthenium complex in the presence of potassium *tert*-butoxide and sodium carbonate as racemization catalyst, CAL-B as biocatalyst, isopropenyl acetate as acyl donor in dry toluene at 25 °C allowing the recovery of the corresponding enantiopure (*R*)-acetate in 96% isolated yield after 20 h.²¹

2.2. Proteases in the resolution of esters through hydrolytic processes

Serine proteases are enzymes that traditionally have been known for cutting peptide bonds in proteins; however, they can also behave as lipases catalyzing stereoselective acetylation and especially hydrolytic reactions. The three dimensional structure of subtilisin, protease obtained from *Bacillus subtilis*, has been determined by X-ray crystallography and Kazlauskas and co-workers have exhaustively analyzed its enantiopreference towards secondary alcohols and acetates. In this manner, some pyridine derivatives were studied in hydrolysis reactions observing different stereopreferences for the formation of the (*R*)-alcohols depending on the subtilisin source and the substrate employed in the enzymatic reaction (Scheme 15).²²

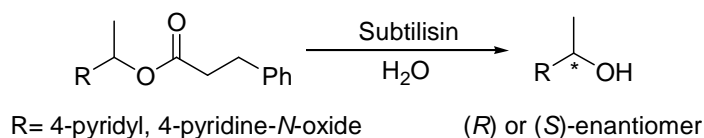

Scheme 15. Enzymatic hydrolysis of pyridine derivatives catalyzed by proteases.

The alkaline protease from *Bacillus lentus* catalyzed the kinetic resolution of racemic 2-[3-[[5-methylisoxazol-3-yl]carbonyl]amino]-2-oxo-pyridin-1(2*H*)-yl]pent-4-onyl methyl or ethyl esters

derivatives leading to the corresponding enantiomerically pure (*S*)-acids, key intermediates in the synthesis of a human rhinovirus protease inhibitor (Scheme 16).²³ Moreover, the (*R*)-ester can be readily recycled via a DBU catalyzed racemization, so the reaction can be repeated for several cycles in a repetitive batch process.

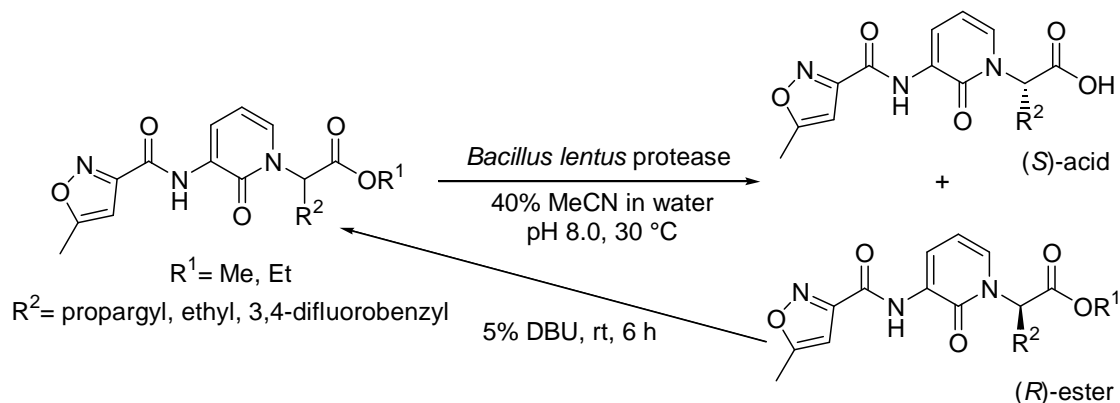

Scheme 16. Repetitive enzymatic process catalyzed by a protease for the production of an interesting human rhinovirus protease inhibitor intermediate precursor.

2.3. Asymmetrization or desymmetrization procedures of diols or diacetates using lipases

Lipases have made also possible the asymmetrization of pyridyl substituted 1,3-propanediols by enantioselective acetylation in organic solvents, being supported pig pancreatic lipase (PPL) the most promising biocatalyst (Scheme 17).²⁴ Monoacetates were obtained in good yields and high enantiomeric excesses going the reactions in all cases over 50% conversion. Hydrolytic procedures were also studied but lower selectivities were obtained.

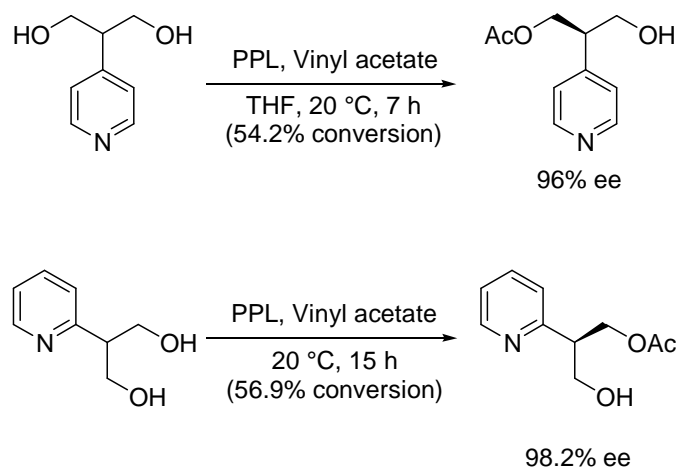

Scheme 17. Enzymatic desymmetrization of prochiral pyridines.

PSL and CAL-B have been found as powerful biocatalytic agents in the chemoenzymatic preparation of stereoisomers of 2,6-bis(1-hydroxyethyl)pyridines and their corresponding acetates (Scheme 18).²⁵ Starting material is composed by a racemic mixture and a *meso*-diol or *meso*-diacetate, so a resolution process and a desymmetrization occurred simultaneously, obtaining a ratio of the different alcohol, mono- or diacetates depending on the enzymatic reaction conditions.

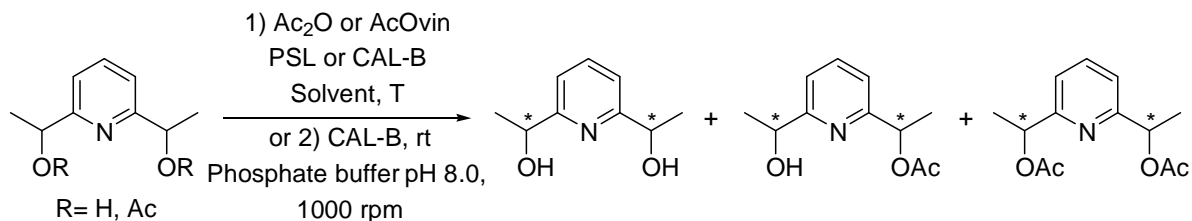

Scheme 18. Simultaneous enzymatic resolution and desymmetrization of diols by acetylation of hydrolysis strategies.

2.4. Enzymatic kinetic resolution of racemic amines

Traditional synthetic methods to obtain optically active amines use chiral organometallic catalysts for the reduction of amine precursors as imines; however, the preparation of enantioenriched amines *via* lipase-catalyzed enantioselective acylation can be accomplished using mild conditions, non toxic reagents, easy experimental procedures and also enzyme recycling. For example, optically active 1-(heteroaryl)ethanamines have attracted very much attention. Gotor and co-workers described for the first time the enzymatic kinetic resolution of 1-pyridin-2-ylethanamine using ethyl acetate (EtOAc) as acyl donor and 1,4-dioxane or the own EtOAc as solvent, obtaining the corresponding amine and amide with high enantiomeric excesses (Scheme 19).²⁶

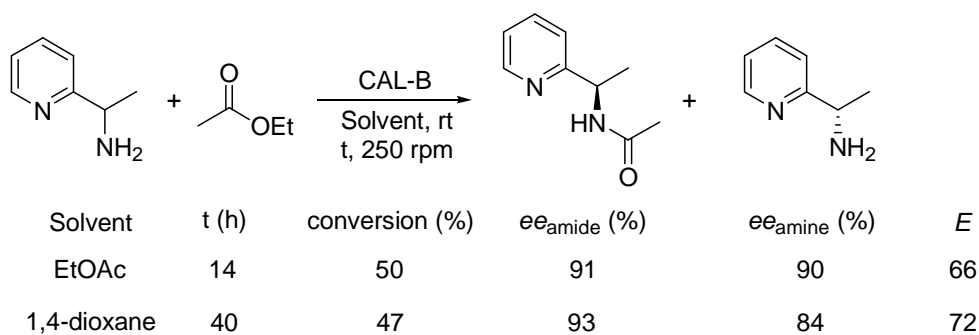

Scheme 19. Kinetic resolution of 1-pyridin-2-ylethanamine.

CAL-B has been traditionally used as the preferred lipase for the kinetic resolution of bicyclic 1-heteroaryl primary amines by enantioselective acylation, achieving generally high yields and enantioselectivities in reactions carried out at 60 °C using EtOAc as acyl donor, obtaining the (*S*)-amines and the (*R*)-acetamides in high optical purities.²⁷

Sigmund and DiCosimo described the lipase-catalyzed acetylation of different racemic 2-(1-aminoethyl)-3-chloro-5-(substituted)-pyridines (Scheme 20).²⁸

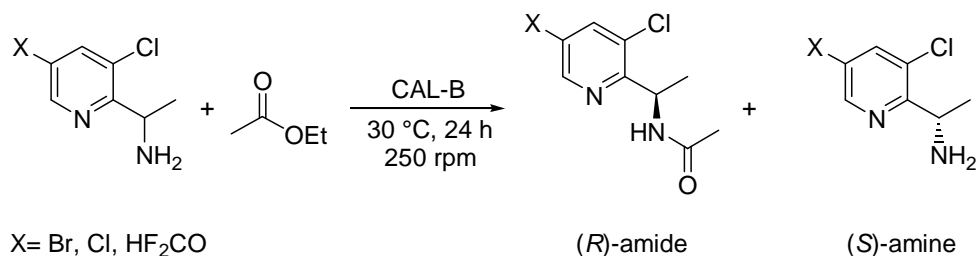

Scheme 20. Enantioselective acetylation of 2-(1-aminoethyl)-3-chloro-5-(substituted)pyridines.

A 94% enantiomeric excess was obtained for the acetylation of (*R*)-2-(1-aminoethyl)-3-chloro-5-bromopyridine using CAL-B in EtOAc, whereas 2-(1-aminoethyl)-3,5-dichloropyridine and 2-(1-aminoethyl)-3-chloro-5-(difluoromethoxy)pyridine were acetylated with low enantioselectivity. Use of methyl propionate, methyl isobutyrate or methyl methoxyacetate instead of EtOAc led to lower enantioselectivity values.

A wide panel of enantiomerically pure 2-(1-aminoalkyl)-4-chloropyridines and 3-(1-aminoalkyl)-4-chloropyridines have been efficiently resolved, being CAL-B and PSL the best biocatalysts in the acetylation reaction using EtOAc or ethyl methoxyacetate as acyl donors and TBME as solvent (Scheme 21).²⁹ The stereoselectivity values were strongly dependent of the alkyl rest and those compounds with R¹= Me or Et showed the best stereopreference values.

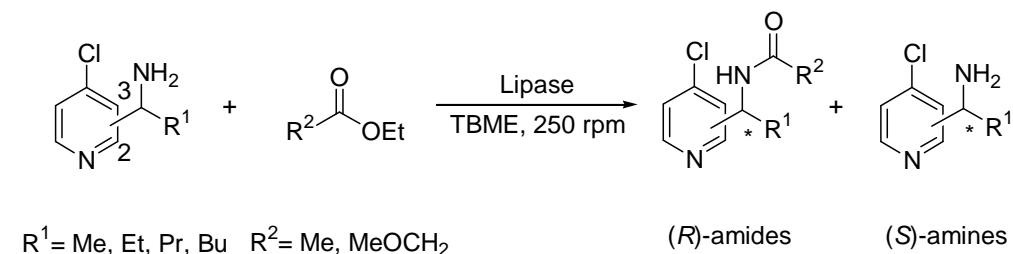

Scheme 21. Enzymatic kinetic resolution of 2-(1-aminoalkyl)-4-chloropyridines and 3-(1-aminoalkyl)-4-chloropyridines.

Ditrich has recently described the CAL-B mediated kinetic resolution of 1-(6-methoxypyridin-3-yl)propan-1-amine using isopropyl methoxyacetate as a novel acylating agent and Et₂O as solvent (Scheme 22), leading to the isolation of enantiomerically pure (*R*)-amide (94% yield) and the (*S*)-amine (85% yield).³⁰

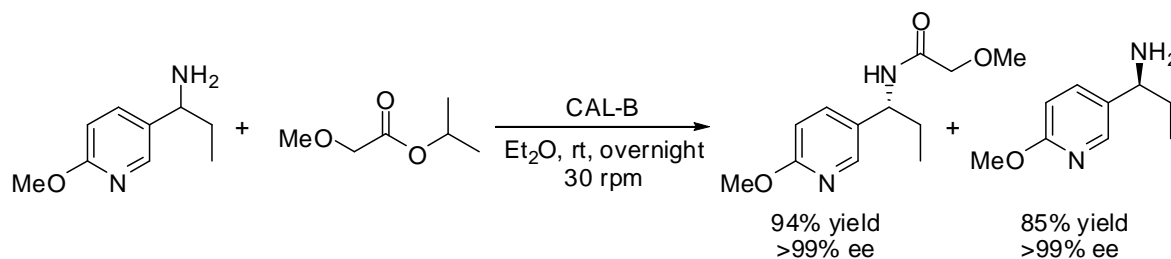

Scheme 22. Enzymatic kinetic resolution of 1-(6-methoxypyridin-3-yl)propan-1-amine.

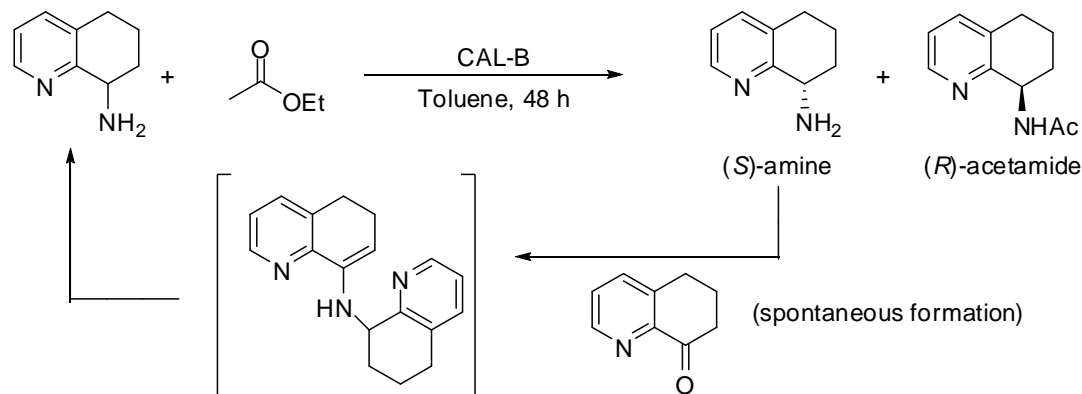

Scheme 23. Dynamic kinetic resolution of 8-amino-5,6,7,8-tetrahydroquinoline.

A spontaneous dynamic kinetic resolution of 8-amino-5,6,7,8-tetrahydroquinoline was observed in the presence of CAL-B, in which over 60% yield of the (*R*)-acetamide was recovered (Scheme 23).³¹ This fact was possible because racemization of the amine occurred due to the formation in the reaction media of the ketone derivative, followed by a condensation-hydrolysis sequence with the remaining (*S*)-amine.

2.5. Classical kinetic resolutions using epoxide hydrolases

Furstoss and co-workers described the hydrolytic kinetic resolution of 2-, 3- and 4-pyridyloxirane by the *Aspergillus niger* GBCF 79 epoxide hydrolase (EH),³² obtaining the corresponding (*S*)-epoxides in nearly enantiopure form (Scheme 24). Experiments were successfully carried out in a gram scale at a 10 g/L concentration showing great advantages in comparison with traditional heavy-metal catalyzed approaches due to the mild reactions conditions employed as the use of inexpensive plain water as solvent.

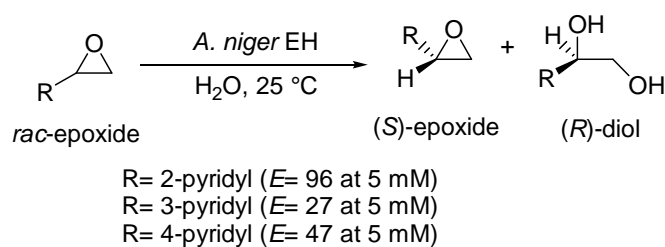

Scheme 24. Kinetic resolution of pyridyloxiranes using epoxide hydrolases.

3. Use of oxidoreductases

Redox enzymes are usually divided into three categories: dehydrogenases, oxidases and oxygenases, being alcohol dehydrogenases (ADHs) the most useful enzymes for the production of optically active pyridines using bioreduction procedures of the corresponding ketones.

3.1. Alcohol dehydrogenases

3.1.1. Bioreductions

Bioreduction reactions involving pyridine derivatives have been described for the preparation of pyridine ethanols, as they are interesting compounds as pharmaceutical intermediates but also as useful chiral ligands and auxiliaries in asymmetric synthesis.³³ For this reason, many bioreduction procedures have been developed including the use of whole cells and isolated alcohol dehydrogenases, with the aim to prepare (*R*)- or either (*S*)-pyridylethanols with high isolated yields and optical purities. Many enzymes have been employed for this purpose such as *Cryptococcus macerans*,^{33a} *Sporotrichum exile*,^{33b} *Lactobacillus kefir* ADH,^{33c} *Daucus carota* cells,^{33d} *Geotrichum candidum*,^{33e} Baker's yeast,^{33f} *Diplogelasinospora grovesii*,^{33g} *Rhodococcus ruber* DSM 44542,^{33h} *Candida viswanathi*,³³ⁱ *Rhodotorula glutinis* var. *dairenensis*,^{33j} and *Rhodotorula sp.*^{33k} This enantiomerically enriched pyridylethanols have been successfully used in the preparation of interesting alkaloids such as akuamidine and heteroyohimidine and macrobicyclic antibiotics. The main difference between the use of whole cells systems and isolated purified dehydrogenases is that these ones require cofactor recycling, which usually made more expensive the enzymatic processes, although on the other hand whole cells reactions need more sophisticated equipments and suffer of tedious work-up extraction steps.

Both enantiomers of 2- and 4-(1-hydroxyethyl)pyridines were prepared by bioreduction of the corresponding ketones with a single microbe (*Geotrichum candidum* IFO 5767).³⁴ Thus, this microorganism afforded (*S*)-alcohols in excellent *ee* when Amberlite XAD-7, a hydrophobic polymer, was added to the reaction system. Meanwhile, when the reaction was carried out in aerobic conditions, the same microbe afforded (*R*)-alcohols in excellent *ee*, based on the fact that, in these reaction conditions, the oxidation from ketone to the corresponding (*S*)-alcohol is reversible and the reduction from ketone to the (*R*)-alcohol is irreversible (Scheme 25).

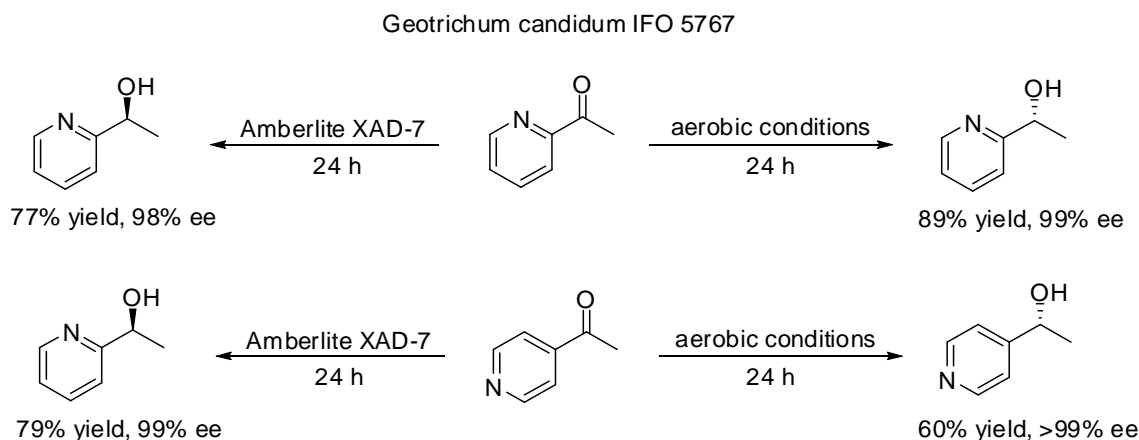

Scheme 25. Asymmetric reduction of ketones with *Geotrichum candidum* IFO 5767.

Gotor and co-workers reported a bioreduction route using Baker's yeast for the preparation of enantioenriched 4-chloro-(2-hydroxyalkyl)pyridines and 4-chloro-2-(hydroxybenzyl)pyridine, precursors of interesting chiral 4-DMAP derivatives.^{6b} This procedure allowed to recover (*S*)-4-chloro-2-(1-hydroxyethyl)pyridine in 76% isolated yield (98% *ee*) and (*R*)-4-chloro-2-(1-hydroxybenzyl)pyridine in 84% isolated yield (98% *ee*); however, bulkier aliphatic alcohols were recovered with lower optical purities (Scheme 26).

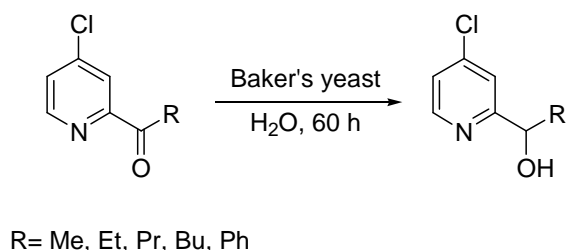

Scheme 26. Bioreduction of 4-chloropyridyl ketones using Baker's yeast.

A short enantioselective synthesis of different 3-substituted DMAP chiral derivatives, which have shown promising results in asymmetric catalysis, was achieved based on a two-step protocol consisting in a chemical oxidation process followed by an enzymatic reduction step.⁷ The corresponding (*S*)-alcohols were isolated in 73–79% yield and >99% *ee*, which later were easily transformed into the corresponding 4-(*N,N*-dimethylamino) derivatives (Scheme 27).

(*R*)-5-(Hydroxyethyl)furo[2,3-*c*]-pyridine (FPH), an important intermediate in the synthesis of HIV reverse-transcriptase inhibitor was prepared through microbial reduction of 5-acetylfuro[2,3-*c*]-pyridine

(AFP) using the yeast *Candida maris* IFO10003 (Scheme 28).³⁵ The cells accumulated 17.5 g/L of (*R*)-FPH in 99% yield and 97% *ee*, meanwhile a cell free extract of *Candida maris* produced 91.5 g/L of the enantiopure alcohol with enzymatic regeneration of NADH.

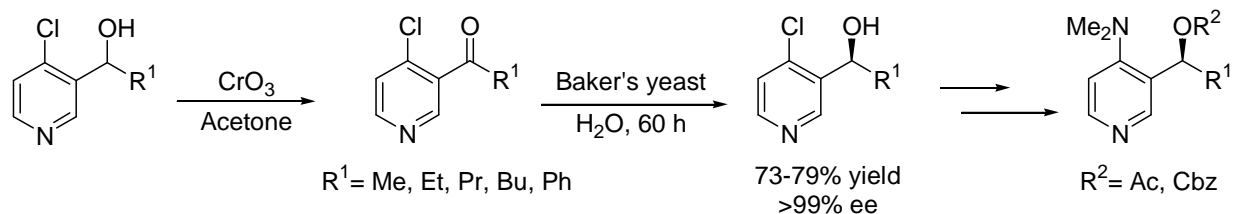

Scheme 27. Preparation of optically active alcohols through a chemical oxidation and enzymatic reduction sequence.

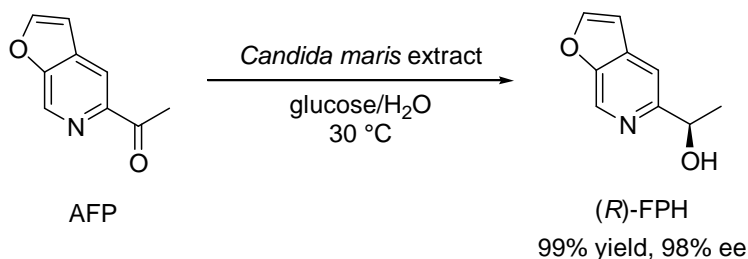

Scheme 28. Enantioselective reduction of 5-acetylfuro[2,3-*c*]-pyridine (AFP) with *Candida maris*.

The chemoenzymatic synthesis of a β_3 adrenergic receptor, that is associated with thermogenesis in adipose tissue, have been performed using a chiral 3-pyridylethanolamine intermediate prepared *via* a yeast-mediated asymmetric reduction of the corresponding ketone with *Candida sorbophila* (Scheme 29).³⁶ The corresponding (*R*)-alcohol was obtained in a very high isolated yield and in enantiopure form after 2 days at 28 °C.

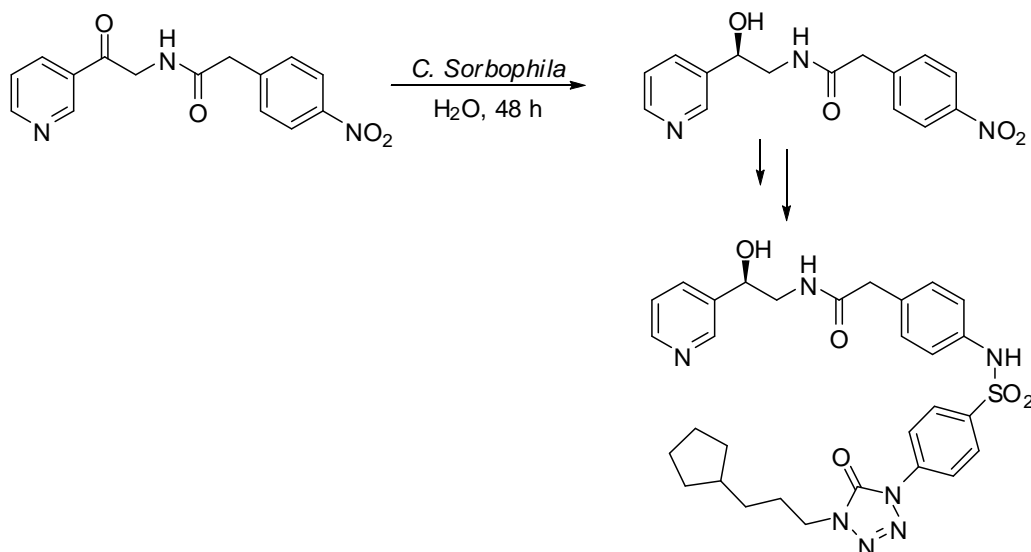

Scheme 29. Preparation of a 3-pyridylamino β_3 adrenergic receptor agonist.

An interesting industrial approach for the synthesis of a different β_3 adrenergic receptor agonist was later described by Scott and co-workers, involving a stereoselective bioreduction step catalyzed by the yeast

Zygosaccharomyces bailii ATCC 38924 (Scheme 30).³⁷ The reaction was performed in a 2g/L substrate concentration obtaining the (*R*)-alcohol in 57% yield with 98% *ee*. The authors exhaustively studied different processes for the production of kilogram quantities of the drug, comparing the best results obtained by chemical or enzymatic catalysis.

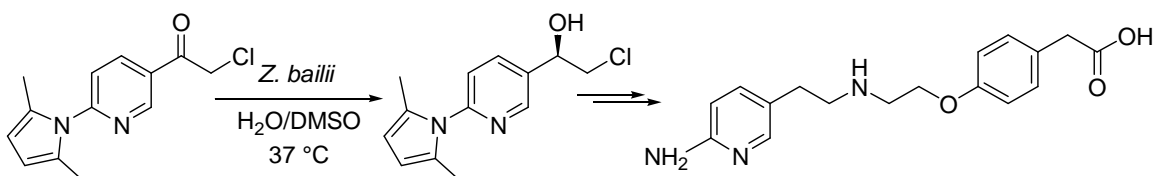

Scheme 30. Preparation of a β_3 adrenergic agonist.

Lin and co-workers reported the bioreduction catalyzed by *Geotrichum sp.* 38 of pyridinyl α -chloromethyl ketone leading to the corresponding (*S*)-chlorhydrin in 91% isolated yield and 81% *ee* (Scheme 31).³⁸ This *ee* value can be improved to >99% by recrystallization over a CH_2Cl_2 -hexane mixture. Next, the (*S*)-chlorhydrin was used to prepare (*S*)- R_0 25-8210 that has been used for the preparation of the matrix metalloproteinase Stromelysin 1 inhibitors.

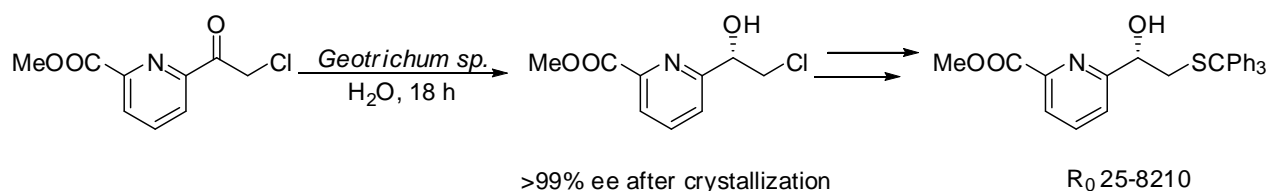

Scheme 31. Preparation of R_0 25-8210.

Recently, an efficient method for cofactor recycling was developed based on the use of permeabilized cells of a reductase-containing microorganism and a glucose dehydrogenase-containing microorganism.³⁹ This procedure was successfully applied to the enantioselective bioreduction of methyl 3-keto-(3'-pyridyl)propionate to obtain the corresponding hydroxyester, which is a useful intermediate in the preparation of the GPIIb/IIIa antagonist RWJ-53308030 (Scheme 32).

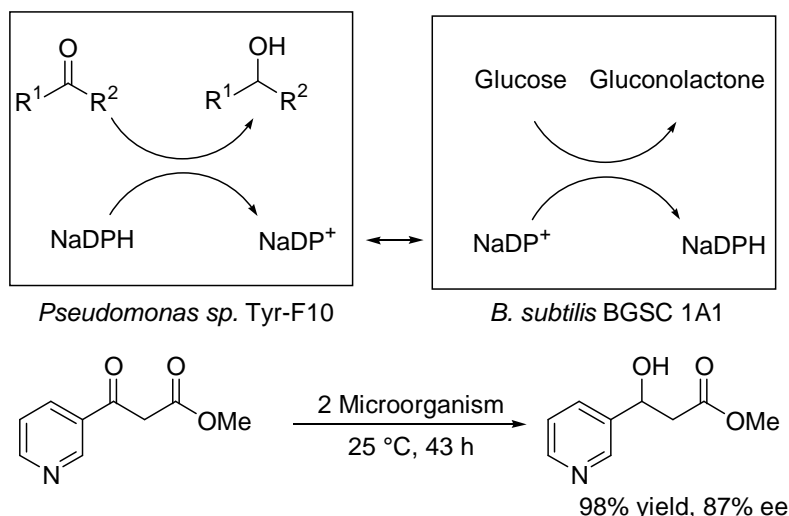

Scheme 32. Enantioselective reduction of ketone with cofactor recycling.

2-, 3- And 4-acetylpyridine-*N*-oxides can be reduced by Baker's yeast in a chemoselective manner to give chiral 2-, 3- and 4-pyridylethanol-*N*-oxides.⁴⁴ The optical purities of the 2- and 3-derivatives were significantly high (96–97% *ee*), however the optical purity of the 4-isomer was much lower (65% *ee*). Meanwhile isolated yields were found much higher for the 2-isomer (95%) in comparison with the 3- or 4-isomers (31–36%, Scheme 37).

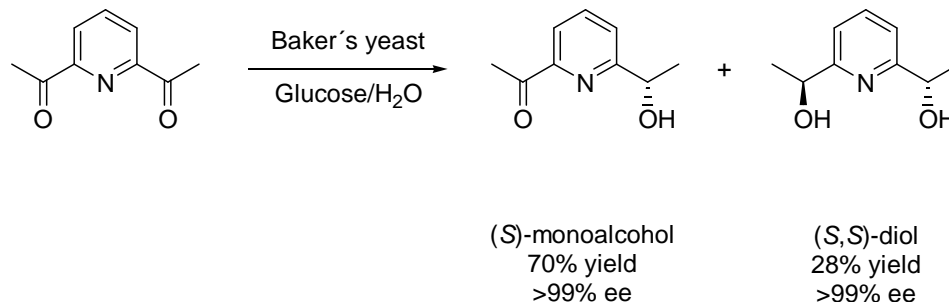

Scheme 36. Bioreduction of 2,6-diacetylpyridine.

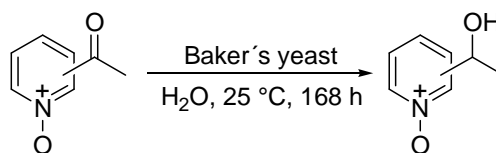

Scheme 37. Bioreduction of pyridine-*N*-oxides.

Recently, Ward and co-workers reported the enantioselective transfer hydrogenation to 2-acetylpyridine catalyzed by artificial metalloenzymes based on Biotin-Streptavidin combined with organometallic catalysts.⁴⁵ The system is far away from being ideal but a new field has been opened combining the best of homogeneous and enzymatic catalysis (Scheme 38).

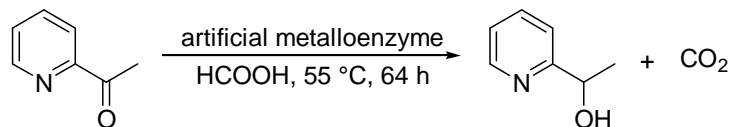

Scheme 38. Reduction of 2-acetylpyridine with an artificial metalloenzyme.

3.1.2. Biooxidations

Biooxidation processes have allowed the preparation of chiral alcohols starting from the corresponding racemic material: in this manner one of the enantiomers is selectively oxidized by the microorganism. Thus, kinetic resolution of 2-pyridylethanol through microbial oxidation was attempted with different microbial sources; however, the reactions occurred with low reaction rates, observing moderate enantiomeric purities of the isolated products and yields limited to 50% (Scheme 39).⁴⁶

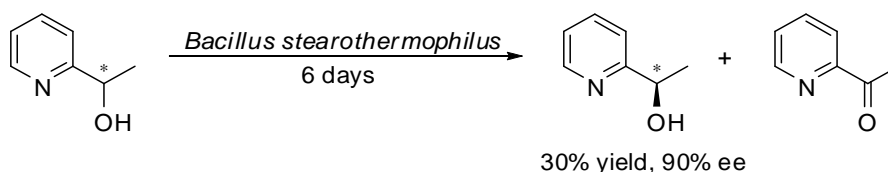

Scheme 39. Kinetic resolution of 2-(1-pyridyl)ethanol by biooxidation.

3.1.3. Deracemizations combining biooxidation and bioreduction processes

This type of procedure is very interesting because it theoretically allows the recovery of the final products in 100% yield and in enantiopure form, in contrast with kinetic resolutions of racemic alcohols where the yield can not exceed 50%.

Achiwa and co-workers reported the deracemization of different pyridyl alcohols, which were incubated with *Catharantus Roseus* cell cultures, obtaining the alcohols with high isolated yields and excellent enantiomeric excesses after several days of incubation (Scheme 40).⁴⁷ Although the mechanism is not clear it seems to work through the biooxidation of one of the enantiomers followed by a stereoselective bioreduction of the ketone.

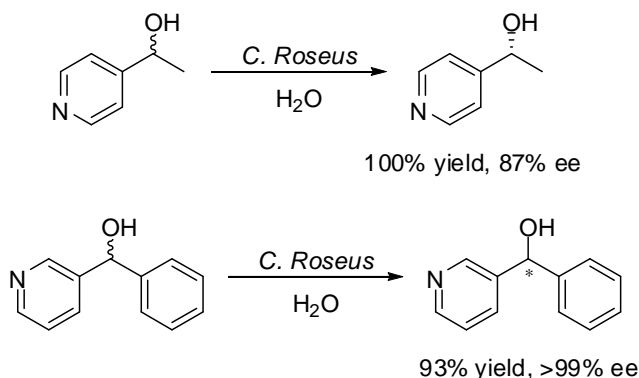

Scheme 40. Deracemization of pyridylalcohols through a biooxidation-bioreduction sequence.

More recently, Nakamura described a very efficient microbial deracemization protocol for the production of optically active pyridylethanols using the cell cultures of *Geotrichum candidum* IFO 5767. The deracemization process is carried out by stereoinversion, being one enantiomer from the racemic mixture transformed into its mirror image. In this manner, the enzyme catalyzed the enantioselective oxidation of one enantiomer to the corresponding ketone and later the sequential bioreduction to the other enantiomer. The pyridinethanols were isolated with excellent optical purities and high isolated yields especially for the 3-substituted derivative (Scheme 41).⁴⁸

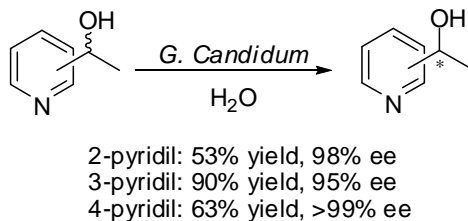

Scheme 41. Deracemization of pyridinethanols with *Geotrichum candidum*.

3.2. Bioxygenations using oxygenases

An oxygenase is an enzyme that oxidizes a substrate by transferring the oxygen from molecular oxygen to it. There are two types of oxygenases:

- Monooxygenases: transfer of one oxygen atom to the substrate and reduce the other oxygen atom to water.
- Dioxygenases: transfer of both atoms of molecular oxygen to the substrate.

Sello and co-workers reported the transformation of 2-vinylpyridine into the corresponding enantiomerically pure (*S*)-epoxide with high isolated yield using an *Escherichia coli* strain containing the styrene monooxygenase gene cloned from *Pseudomonas Fluorescens ST* (Scheme 42).⁴⁹



Scheme 42. Microbial catalyzed epoxidation.

It has been generally accepted that electron deficient rings, specially pyridines, are poor substrates or completely non reactive towards dioxygenases; however, *Pseudomonas Putida* UV4 has been proved to catalyzed benzylic hydroxylation of some alkylbenzene substrates. For this reason, Sheldrake investigated the possibility of direct dioxygenase activity towards the side-chain of alkyl substituted pyridines obtaining exclusively side chain oxidation in 3-alkylpyridines and partial side chain oxidation in 2-alkylpyridines meanwhile no oxidation was observed for 4-alkylpyridines (Scheme 43).⁵⁰

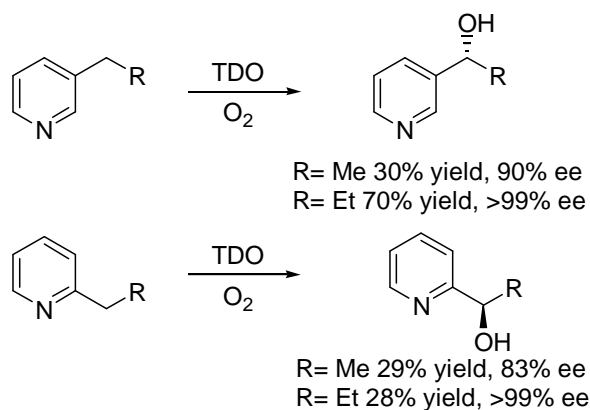

Scheme 43. Biooxygenations of alkyl pyridines with *Pseudomonas Putida* UV4.

The *cis*-dihydroxylation of 4-chloroquinoline have been studied using different hydroxylation agents: in this manner, 4-chloro-5,6-dihydroquinoline-5,6-diol was obtained with poor yield (4%) using whole cells of *Pseudomonas putida* UV4, meanwhile *Sphingomonas yanoikuyae* B8/36 led to the same *cis*-diol in 33% isolated yield (Scheme 44).⁵¹ No evidence of the alternative isomer 4-chloro-7,8-dihydroquinoline-5,6-diol has been found. The 4-chloro-5,6-dihydroquinoline-5,6-diol has been used as an adequate precursor for the synthesis of chiral 4,4'-bipyridines, which are effective building blocks for the preparation of chiral metal-organic frameworks that exhibit interesting properties in enantioselective separation, sensing and catalysis.

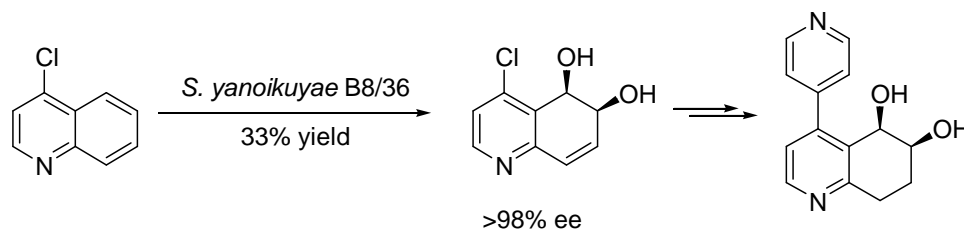

Scheme 44. Preparation of enantiomerically pure 4,4'-bipyridyls *via* bacterial *cis*-dihydroxylation.

4. Use of lyases

Although most of the biocatalytic methods rely on the use of hydrolases or oxidoreductases, there is a number of biotransformations extremely useful for the preparation of enantiomerically pure compounds that involves other class of enzymes, as it is the lyases group. In the case of pyridine derivatives, we have highlighted some examples appeared in the literature along the last decade using oxynitrilases or aldolases.

4.1. Synthesis of chiral cyanohydrins using oxynitrilases

Although it was reported that nitrogen containing heteroaryl carboxaldehydes are poor substrates for hydroxynitrile lyases (HNL),⁵² Roberge and co-workers described the synthesis of (*R*) and (*S*)-cyanohydrins from 3-pyridinecarboxaldehyde in good yields and excellent enantiomeric purities using hydroxynitrile lyases from Cassava (*Manihot Esculenta*, MeHNL) and Almond (*Prunus Amygdalus*, PaHNL) respectively present in commercially available cross linked enzyme aggregates (CLEA, Scheme 45).⁵³

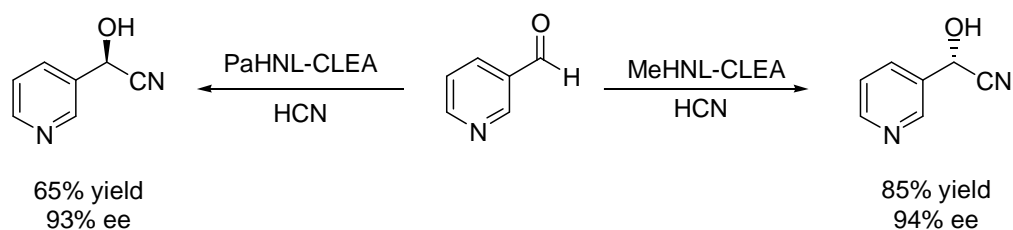

Scheme 45. Preparation of optically active cyanohydrins from 3-pyridinecarboxaldehyde.

4.2. Aldolases for the production of chiral pyridines

Aldolases are enzymes that catalyze C–C bond formation with a high degree of regio-, enantio- and diastereoselectivity. These enzymes are broadly grouped according to the nucleophile type used in the process: dihydroxyacetone phosphate, acetaldehyde, glycine and pyruvate or phosphoenolpyruvate. From a mechanistic perspective, there are two classes of aldolases: the type I use a catalytic lysine to activate the nucleophilic substrate, meanwhile type II aldolases use a Zn^{+2} ion to promote the enolate formation.

Fessner and co-workers reported the condensation of DHAP (dihydroxyacetone phosphate) and 2-pyridinecarboxaldehyde catalyzed by a L-fucose-1-phosphatealdolase (FucA) from *E. coli*.⁵⁴ The condensation product was obtained as a single diastereomer, enantiomerically pure and with moderate yield (Scheme 46).

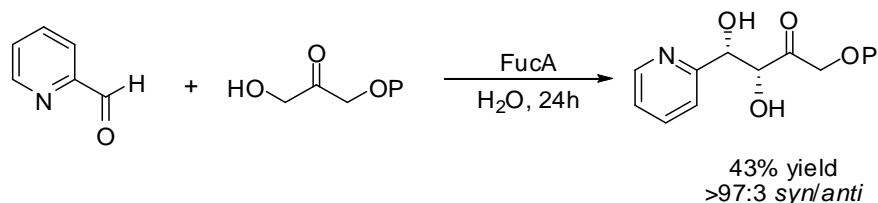

Scheme 46. Condensation between 2-pyridinecarboxaldehyde and DHAP catalyzed by FucA.

A pyruvate dependent 2-keto-3-deoxy-6-phosphogalactonate (KDPGal) aldolase from *P. cepacia* strain 249-27 was employed in the enantioselective preparation of (*R*)-4-hydroxy-2-keto-4-(2'-pyridyl)butyrate, by condensation of pyruvate and 2-pyridinecarboxaldehyde.⁵⁵ The product was isolated as a single enantiomer and in good yield (Scheme 47).

A sequential enzymatic process combining a 2-keto-3-deoxy-6-phosphogluconate (KDPG) aldolase from *E. coli* and a phenylalanine dehydrogenase (Phe DH) was employed in the preparation of the N-terminal amino acid moiety of nikkomycins that are non toxic nucleoside antifungals, which selectively inhibit the fungal cell wall enzyme chitin syntase (Scheme 48).⁵⁶

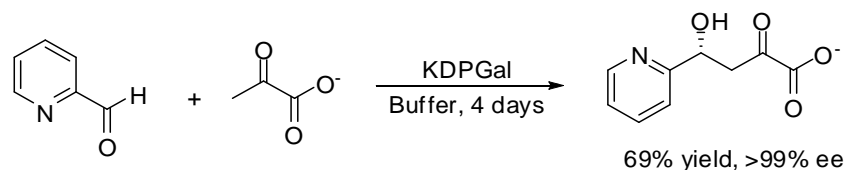

Scheme 47. Preparation of (*R*)-4-hydroxy-2-keto-4-(2'-pyridyl)butyrate catalyzed by KDPGal aldolase.

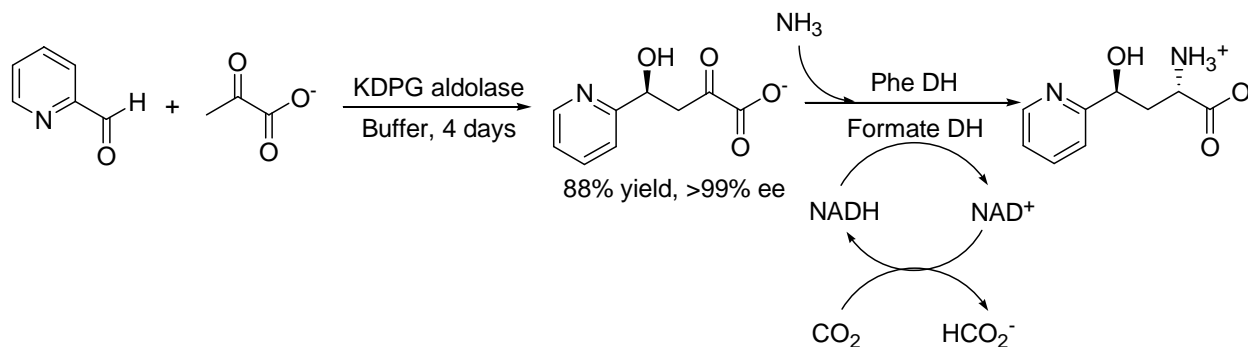

Scheme 48. Synthesis of N-terminal amino acid of nikkomycins through aldol catalyzed reactions.

Enantioenriched (*R*)-pyridyl β -aminoalcohols were prepared starting from glycine and pyridinecarboxylaldehydes in the presence of a threonine aldolase from *P. putida* and a decarboxylase from *Enterococcus faecalis* (Scheme 49).⁵⁷

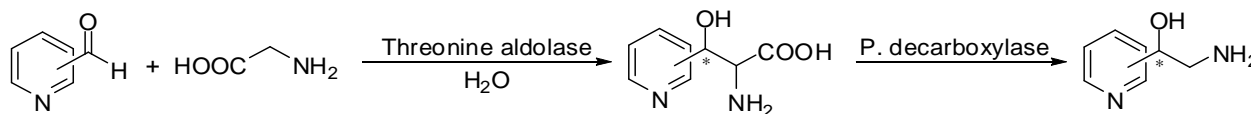

Scheme 49. Preparation of optically active β -aminoalcohols.

5. Concluding remarks

Application of biocatalysts in organic synthesis is currently a well-established methodology for the chemo- and regioselective modification of non-chiral compounds, resolution of racemic mixtures and desymmetrization of prochiral substrates. In this review, we have shown how enzymes can provide access to an interesting family of compounds, the pyridine derivatives, compounds which play an important role in the production of pharmaceuticals, herbicides and fine chemicals. Biotransformations represent elegant and ecological tools for the synthesis of high added value compounds but in addition, the combination of genetic engineering and molecular modelling techniques are playing a major role in the development of new biocatalysts or new enzyme activities that will show in the future better results than those currently presented.

Acknowledgments

This work was supported by the Spanish Ministerio de Ciencia e Innovación (Project CTQ 2007-61126). V. G.-F. thanks the MICINN for a post-doctoral personal grant (Ramón y Cajal Program).

References

- (a) Ziffer, H. A.; Kawai, K.; Kasai, M.; Imuta, M.; Froussios, C. *J. Org. Chem.* **1983**, *48*, 3017–3021. (b) Takeshita, M.; Terada, K.; Akutsu, N.; Yoshida, S.; Sato, T. *Heterocycles* **1987**, *26*, 3051–3054. (c) Rasor, J. P.; Ruchardt, C. *Chem. Ber.* **1989**, *122*, 1375–1376. (d) Laumen, K.; Schneider, M. P. *J. Chem. Soc., Chem. Commun.* **1988**, 598–600. (e) Seemayer, R.; Schneider, M. P. *Tetrahedron: Asymmetry* **1993**, *3*, 827–830. (f) Öhrner, N.; Hult, K. *Tetrahedron: Asymmetry* **1994**, *4*, 1363–1366. (g) Bellezza, F.; Cipiciani, A.; Cruciani, G.; Fringuelli, F. *J. Chem. Soc., Perkin Trans 1* **2000**, 4439–4444. (h) Hatzakis, N. S.; Smonou, I. *Bioorg. Chem.* **2005**, *33*, 325–337.
- Brown, D. G.; Urbanek, R. A.; Bare, T. M.; McLaren, F. M.; Horchler, C. L.; Murphy, M.; Steelman, G. B.; Empfield, J. R.; Forst, J. M.; Herzog, K. J.; Xiao, W.; Dyroff, M. C.; Lee, C.-M. C.; Trivedi, S.; Neilson, K. L.; Keith, R. A. *Bioorg. Med. Chem. Lett.* **2003**, *13*, 3553–3556.
- Itoh, T.; Matsushita, Y.; Abe, Y.; Han, S.; Wada, S.; Hayase, S.; Kawatsura, M.; Takai, S.; Morimoto, M.; Hirose, Y. *Chem. Eur. J.* **2006**, *12*, 9228–9237.
- (a) Amat, M.; Coll, M. D.; Passarella, D.; Bosch, J. *Tetrahedron: Asymmetry* **1996**, *7*, 2775–2778. (b) Amat, M.; Coll, M. D.; Bosch, J.; Espinosa, E.; Molins, E. *Tetrahedron: Asymmetry* **1997**, *8*, 935–948.
- Nagata, K.; Toriizuka, Y.; Itoh, T. *Heterocycles* **2005**, *66*, 107–109.
- (a) Busto, E.; Gotor-Fernández, V.; Gotor, V. *Tetrahedron: Asymmetry* **2005**, *16*, 3427–3435. (b) Busto, E.; Gotor-Fernández, V.; Gotor, V. *Tetrahedron: Asymmetry* **2006**, *17*, 1007–1016. (c) Busto, E.; Gotor-Fernández, V.; Gotor, V. *Nature Protocols* **2006**, *1*, 2061–2067.
- Busto, E.; Gotor-Fernández, V.; Gotor, V. *Adv. Synth. Catal.* **2006**, *348*, 2626–2632.
- Takayama, H.; Maeda, M.; Ohbayashi, S.; Kitajima, M.; Sakai, S.; Aimi, N. *Tetrahedron Lett.* **1995**, *36*, 9337–9340.
- Uenishi, J.; Nishiwaki, K.; Hata, S.; Nakamura, K. *Tetrahedron Lett.* **1994**, *35*, 7973–7976.
- Uenishi, J.; Hiraoka, T.; Hata, S.; Nishiwaki, K.; Yonemitsu, O. *J. Org. Chem.* **1998**, *63*, 2481–2487.
- Perrone, M. G.; Santandrea, E.; Giorgio, E.; Bleve, L.; Scilimati, A.; Tortorella, P. *Bioorg. Med. Chem.* **2006**, *14*, 1207–1214.
- Guanti, G.; Riva, R. *Tetrahedron: Asymmetry* **2001**, *12*, 1185–1200.
- Uenishi, J.; Hamada, M. *Synthesis* **2002**, 625–630.
- Takeshita, M.; Yoshida, S.; Sato, T.; Akutsu, N. *Heterocycles* **1993**, *35*, 879–884.
- Takemoto, M.; Moriyasu, Y.; Achiwa, K. *Chem. Pharm. Bull.* **1995**, *43*, 1458–1461.
- Takemoto, M.; Yamamoto, Y.; Achiwa, K. *Chem. Pharm. Bull.* **1998**, *46*, 419–422.
- Nestl, B. M.; Bodlenner, A.; Stuermer, R.; Hauer, B.; Kroutil, W.; Faber, K. *Tetrahedron: Asymmetry* **2007**, *18*, 1465–1474.
- Chimni, S. S.; Singh, S.; Kumar, S.; Mahajan, S. *Tetrahedron: Asymmetry* **2002**, *13*, 511–517.
- Henegar, K. E.; Ashford, S. W.; Baughman, T. A.; Sih, J. C.; Gu, R.-L. *J. Org. Chem.* **1997**, *62*, 6588–6597.
- Akita, H.; Takano, Y.; Nedu, K.; Kato, K. *Tetrahedron: Asymmetry* **2006**, *17*, 1705–1714.
- Martín-Matute, B.; Edin, M.; Bogar, K.; Kaynak, F. B.; Bäckvall, J.-E. *J. Am. Chem. Soc.* **2005**, *127*, 8817–8825.
- Savile, C. K.; Kazlauskas, R. J. *J. Am. Chem. Soc.* **2005**, *127*, 12228–12229.
- Martinez, C. A.; Yazbeck, D. R.; Tao, J. *Tetrahedron* **2004**, *60*, 759–764.
- Guanti, G.; Narisano, E.; Riva, R. *Tetrahedron: Asymmetry* **1997**, *8*, 2175–2187.
- (a) Wallace, J. S.; Baldwin, B. W.; Morrow, C. J. *J. Org. Chem.* **1992**, *57*, 5231–5239. (b) Szakter, G.; Móczár, I.; Kolonits, P.; Novák, L.; Huszthy, P.; Poppe, L. *Tetrahedron: Asymmetry* **2004**, *15*, 2483–2490. (c) Uenishi, J.; Aburatani, S.; Takami, T. *J. Org. Chem.* **2007**, *72*, 132–138.
- Iglesias, L. E.; Sánchez, V. M.; Rebolledo, F.; Gotor, V. *Tetrahedron: Asymmetry* **1997**, *8*, 2675–2677.
- Skupinsa, K. A.; McEachern, E. J.; Baird, I. R.; Skerlj, R. T.; Bridger, G. J. *J. Org. Chem.* **2003**, *68*, 3546–3551.
- Sigmund, A. E.; DiCosimo, R. *Tetrahedron: Asymmetry* **2004**, *15*, 2797–2799.
- Torre, O.; Busto, E.; Gotor-Fernández, V.; Gotor, V. *Adv. Synth. Catal.* **2007**, *349*, 1481–1488.
- Ditrich, K. *Synthesis* **2008**, 2283–2287.
- Crawford, J. B.; Skerlj, R. T.; Bridger, G. J. *J. Org. Chem.* **2007**, *72*, 669–671.

32. (a) Genzel, Y.; Archelas, A.; Broxterman, Q. B.; Schulze, B.; Furstoss, R. *Tetrahedron: Asymmetry* **2000**, *11*, 3041–3044. (b) Genzel, Y.; Archelas, A.; Broxterman, Q. B.; Schulze, B.; Furstoss, R. *J. Org. Chem.* **2001**, *66*, 538–543.
33. (a) Imuta, M.; Ziffer, H. *J. Org. Chem.* **1978**, *43*, 3530–3532. (b) Uskokovic, M. R.; Lewis, R. L.; Partridge, J. J.; Despreaux, C. W.; Pruess, D. L. *J. Am. Chem. Soc.* **1979**, *101*, 6742–6744. (c) Bradshaw, C. W.; Hummel, W.; Wong, C.-H. *J. Org. Chem.* **1992**, *57*, 1532–1536. (d) Akakabe, Y.; Takahashi, M.; Kamezawa, M.; Kikuchi, K.; Tachibana, H.; Takehiko, O.; Naoshima, Y. *J. Chem. Soc., Perkin Trans. 1* **1995**, 1295–1298. (e) Nakamura, K.; Fujii, M.; Ida, I. *J. Chem. Soc., Perkin Trans. 1* **2000**, 3205–3211. (f) Shin, C.-G.; Okabe, A.; Ito, A.; Ito, A.; Yonezawa, Y. *Bull. Chem. Soc. Jpn.* **2002**, *75*, 1583–1596. (g) Carballeira, J. D.; Álvarez, E.; Campillo, M.; Pardo, L.; Sinisterra, J. V. *Tetrahedron: Asymmetry* **2004**, *15*, 951–962. (h) Stampfer, W.; Edegger, K.; Kosjek, B.; Faber, K.; Kroutil, W. *Adv. Synth. Catal.* **2004**, *346*, 57–62. (i) Soni, P.; Kaur, G.; Chakraborti, A. K.; Banerjee, U. C. *Tetrahedron: Asymmetry* **2005**, *16*, 2425–2428. (j) Kizaki, N.; Sawa, I.; Yano, M.; Yasohara, Y.; Hasegawa, J. *Biosci. Biotechnol. Biochem.* **2005**, *69*, 79–86. (k) Yang, W.; Xu, J.-H.; Xie, Y.; Xu, Y.; Zhao, G.; Lin, G.-Q. *Tetrahedron: Asymmetry* **2006**, *17*, 1769–1774.
34. Nakamura, K.; Takenaka, K.; Fujii, M.; Ida, Y. *Tetrahedron Lett.* **2002**, *43*, 3629–3631.
35. Kawano, S.; Horikawa, M.; Yasohara, Y.; Hasegawa, J. *Biosci. Biotechnol. Biochem.* **2003**, *67*, 809–814.
36. Chung, J. Y. L.; Ho, G.-J.; Chartrain, M.; Roberge, C.; Zhao, D.; Leazer, J.; Farr, R.; Robbins, M.; Emerson, K.; Mathre, D. J.; McNamara, J. M.; Hughes, D. L.; Grabowski, E. J. J.; Reider, P. J. *Tetrahedron Lett.* **1999**, *40*, 6739–6743.
37. Scott, R. W.; Fox, D. E.; Wong, J. W.; Burns, M. P. *Org. Process Res. Dev.* **2004**, *8*, 587–592.
38. Wei, Z.-L.; Li, Z.-Y.; Lin, G.-Q. *Tetrahedron* **1998**, *54*, 13059–13072.
39. Zhang, J.; Witholt, B.; Li, Z. *Chem. Commun.* **2006**, 398–400.
40. Takemoto, M.; Tanaka, K. *J. Mol. Catal. B: Enzym.* **2001**, *15*, 173–176.
41. Truppo, M. D.; Pollard, D.; Devine, P. *Org. Lett.* **2007**, *9*, 335–338.
42. Jen, S. J.; Truppo, M. D.; Amos, D.; Devine, P.; McNevin, M.; Biba, M.; Campos, K. R. *Org. Lett.* **2008**, *10*, 741–744.
43. (a) Bailey, D.; O' Hagan, D.; Dyer, U.; Lamont, R. B. *Tetrahedron: Asymmetry* **1993**, *4*, 1255–1258. (b) Uchiyama, M.; Katoh, N.; Mimura, R.; Yokota, N.; Shimogachi, Y.; Shimizaki, M.; Ohta, A. *Tetrahedron: Asymmetry* **1997**, *8*, 3467–3474.
44. Takeshita, M.; Yoshida, S. *Heterocycles* **1990**, *30*, 871–874.
45. Letondor, C.; Pordea, A.; Humbert, N.; Ivanova, A.; Mazurek, S.; Novic, M.; Ward, T. R. *J. Am. Chem. Soc.* **2006**, *128*, 8320–8238.
46. (a) Fantin, G.; Fogagnolo, M.; Medici, A.; Pedrini, P.; Poli, S.; Sinigaglia, M. *Tetrahedron Lett.* **1993**, *34*, 883–884. (b) Fantin, G.; Fogangolo, M.; Medici, A.; Pedrini, P.; Poli, S. *Tetrahedron: Asymmetry* **1993**, *4*, 1607–1612. (c) Fantin, G.; Fogangolo, M.; Guerzoni, M. E.; Medici, A.; Pedrini, P.; Poli, S. *J. Org. Chem.* **1994**, *59*, 924–925.
47. (a) Takemoto, M.; Achiwa, K. *Tetrahedron: Asymmetry* **1995**, *6*, 2925–2928. (b) Takemoto, M.; Achiwa, A. *Chem. Pharm. Bull.* **1998**, *46*, 577–580.
48. Nakamura, K.; Fujii, M.; Ida, Y. *Tetrahedron: Asymmetry* **2001**, *12*, 3147–3153.
49. Bernasconi, J.; Orsini, F.; Sello, G.; Colmegna, A.; Galli, E.; Bestetti, G. *Tetrahedron Lett.* **2000**, *41*, 9157–9161.
50. Garret, M. D.; Scott, R.; Sheldrake, G. N. *Tetrahedron: Asymmetry* **2002**, *13*, 2201–2204.
51. Sbircea, L.; Sharma, N. D.; Clegg, W.; Harrington, R. W.; Horton, P. N.; Hursthouse, M. B.; Apperley, D. C.; Boyd, D. R.; James, S. L. *Chem. Commun.* **2008**, 5538–5540.
52. (a) Effenberg, F.; Ziegler, T.; Forster, S. *Angew. Chem. Int. Ed.* **1987**, *26*, 458–460. (b) Chen, P.; Han, S.; Lin, G.; Huang, H.; Li, Z. *Tetrahedron: Asymmetry* **2001**, *12*, 3273–3279.
53. Roberge, C.; Fleitz, F.; Pollard, D.; Devine, P. *Tetrahedron Lett.* **2007**, *48*, 1473–1477.
54. Fessner, W.-D.; Sinerius, G.; Schneider, A.; Dreyer, M.; Schulz, G. E.; Badía, J.; Aguilar, J. *Angew. Chem. Int. Ed.* **1991**, *30*, 555–558.

55. (a) Henderson, D. P.; Cotterill, I. C.; Shelton, M. C.; Toone, E. J. *J. Org. Chem.* **1998**, *63*, 906–907.
(b) Walters, M. J.; Srikannathasan, V.; McEwan, A. R.; Naismith, J. M.; Fierke, C. A.; Toone, E. J. *Bior. Med. Chem.* **2008**, *16*, 710–720.
56. Henderson, D. P.; Shelton, M. C.; Cotterill, I. C.; Toone, E. J. *J. Org. Chem.* **1997**, *62*, 7910–7911.
57. Schuermann, M.; Mink, D.; Wolberg, M. PCT Int. Appl. WO 2007118682, 2007.

ASYMMETRIC SYNTHESIS OF SUBSTITUTED PIPERAZINES

Jean-Charles Quirion

UMR 6014 CNRS, COBRA. Université and INSA de Rouen,
Rue Tesnière F-76821 Mont-Saint-Aignan Cedex, France (e-mail: quirion@insa-rouen.fr)

Abstract. Recent advances in the asymmetric synthesis of substituted piperazines are surveyed.

Contents

1. Introduction
 2. Resolution and diastereomeric separation
 - 2.1. Chemical resolution
 - 2.2. Enzymatic resolution
 - 2.3. Diastereomeric separation
 3. Reduction of 2-keto and diketopiperazines
 - 3.1. Reduction of 2-ketopiperazines
 - 3.2. Reduction of 2,3-diketopiperazines
 - 3.3. Reduction of 2,5-diketopiperazines
 4. Reduction of tetrahydropyrazines
 - 4.1. Reduction of chiral tetrahydropyrazines
 - 4.2. Asymmetric hydrogenation of tetrahydropyrazines
 5. Reductive cyclization of diamines
 - 5.1. Diastereoselective cyclization
 - 5.2. Enantioselective cyclization
 6. Cyclization of diaminoalcohols
 7. Cyclization of diamines
 - 7.1. Nucleophilic substitution
 - 7.2. Reductive amination
 - 7.3. Allylic substitution
 8. Amination and carboamination of olefins
 9. Direct functionalization of substituted piperazines
 - 9.1. Selective alkylation of substituted piperazines
 - 9.2. *N*-Selective functionalization
 10. Conclusions
- References

1. Introduction

Piperazines (Figure 1) are an important class of nitrogen-containing heterocycles that are common in pharmaceutical agents. A recent survey of biologically relevant templates in the MDDR revealed more than two thousands biologically active molecules containing *N*-aryl piperazines.¹ Piperazine nuclei are found in a

range of biologically active compounds, they display high affinity for various receptors within the central nervous system (CNS) and are incorporated as substructures into several pharmacologically useful compounds such as Merck HIV-protease inhibitors (Indinavir) (Crixivan®).² The presence of substituents on the carbons of the ring and the absolute configuration of the chiral centres have a significant influence on the biological activity of these compounds. Furthermore, due to their structural rigidity, piperazines have found applications as ligands in asymmetric catalysis.³

This report will examine the different asymmetric synthetic methods used to prepare substituted piperazines. Although piperazines are very often synthesized from keto or diketopiperazines, the specific methods of preparation of these compounds will not be developed in this article.⁴ Only syntheses where these compounds are used as intermediates in the preparation of piperazines will be presented.

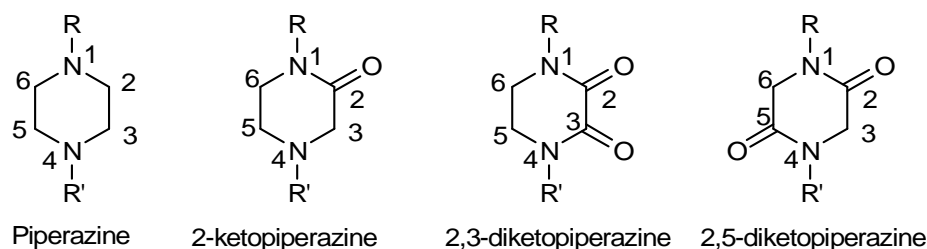

Figure 1. Piperazine, ketopiperazine and diketopiperazine skeletons.

The results are presented according to the methods used to prepare piperazine skeleton. The synthesis of the following classes of derivatives (Figure 2) will be presented along the different sections.

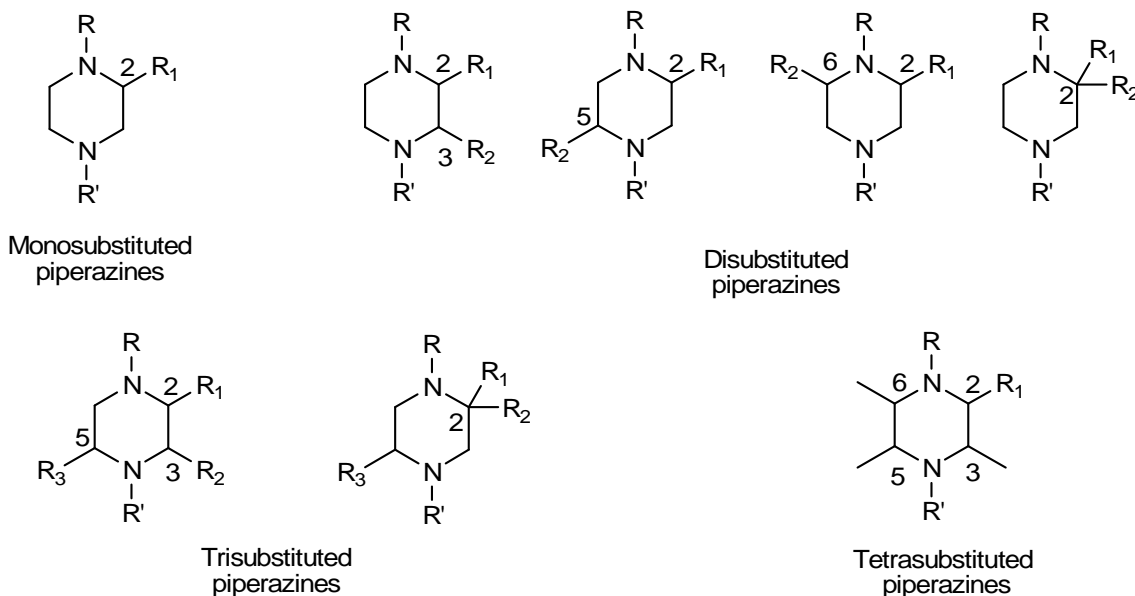
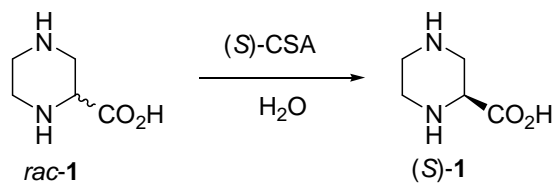

Figure 2. Substituted piperazines.⁵

2. Resolution and diastereomeric separation

2.1. Chemical resolution

Simple resolution of the racemate **1** via formation of diastereomeric salt pairs has first been reported by Felder using (*S*)-camphorsulfonic acid [(*S*)-CSA] (Scheme 1).⁶ A continuous resolution process with the same resolving agent acting as an epimerisation agent has been further described.⁷



Scheme 1

During the synthesis of Indinavir,⁸ Merck chemists described a resolution process of *t*-butyl amide **2**, using pyrroglutamic acid **3** as the resolving agent (Scheme 2).

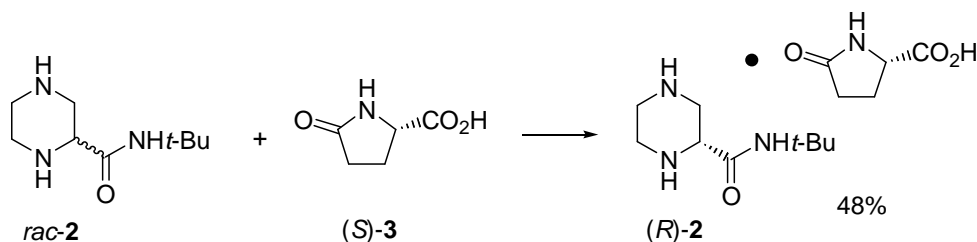

Scheme 2

(+) And (–)-1,4-dibenzyl-2-(hydroxymethyl)piperazines **4** have been obtained as pure enantiomers from the racemic alcohol by means of fractional crystallization with the chiral (+)-mandelic acid (Scheme 3).⁹

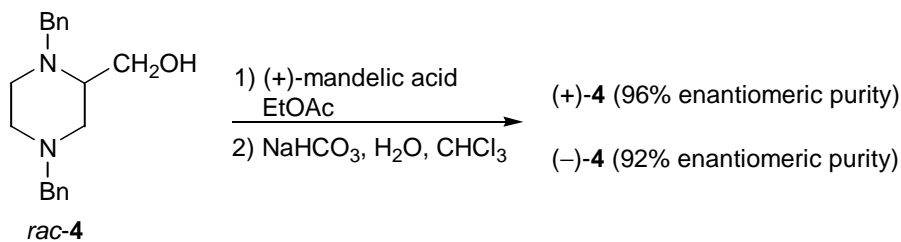

Scheme 3

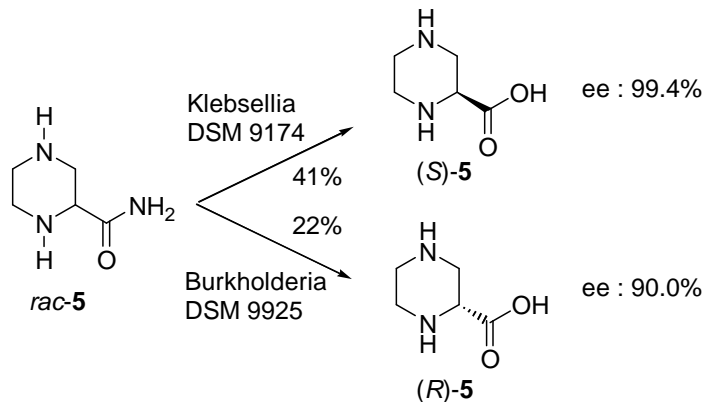

Scheme 4

2.2. Enzymatic resolution

Enzymatic resolution has also been used to prepare pure aminoacid. Kinetic resolution of racemic 4-(*tert*-butoxycarbonyl)piperazine-2-carboxamide with leucine aminopeptidase furnished (*S*)-piperazine-2-

carboxylic acid,¹⁰ *R*-amidase acted *R*-stereoselectively on racemic piperazine-2-*tert*-butylcarboxamide to yield (*R*)-piperazine-2-carboxylic acid.¹¹ Whole bacterial cells containing specific stereospecific amidases have also been used for the kinetic resolution of racemic piperazine-2-carboxamide (Scheme 4).¹²

2.3. Diastereomeric separation

Pure aminoacid (*R*)-**1** has also been prepared by acidic or BCl₃ hydrolysis of pure menthyl ester **7** prepared from racemic methyl ester **6** in a two step procedure followed by separation of the diastereomeric mixture (Scheme 5).¹³

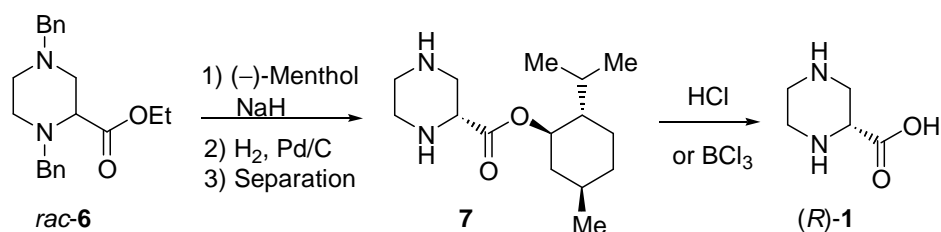

Scheme 5

3. Reduction of 2-keto and diketopiperazines

The simplest approach to monosubstituted piperazines consists of reduction of monosubstituted keto or diketopiperazines. These compounds can be generally synthesized *via* the cyclodimerization of aminoacids or cyclization of diaminoesters.¹⁴ Some representative examples are given below.

3.1. Reduction of 2-ketopiperazines

2,6-Di- and 2,2,6-trisubstituted piperazines **12** and **15** have been synthesized following the same strategy involving the stereoselective reaction of chiral triflate **8** with an amine leading to chiral diaminoesters **9** and **13** (Scheme 6).¹⁵ After deprotection of the terminal amine, cyclization provided lactams **10** and **14** which were then reduced (LiAlH₄).

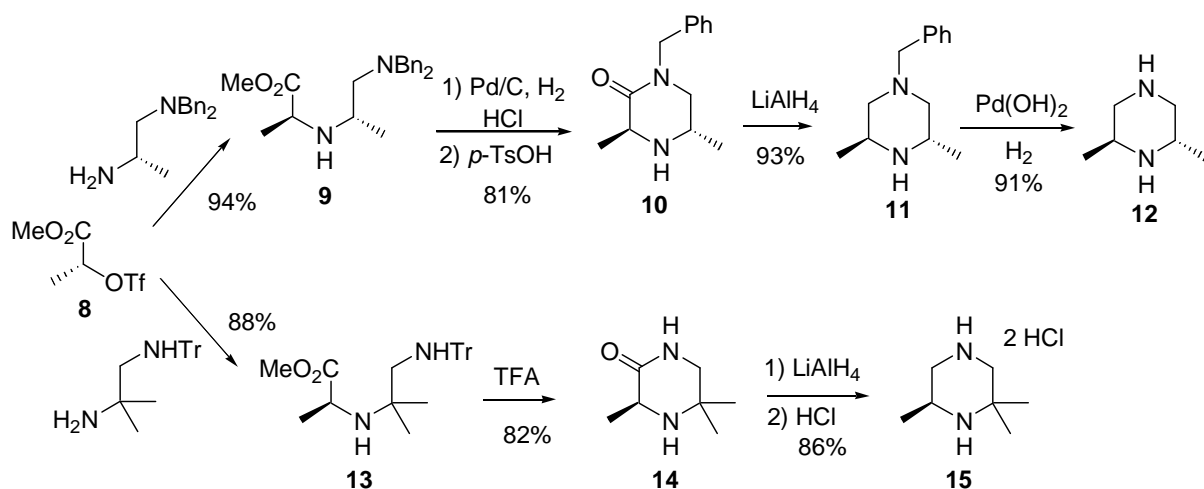

Scheme 6

During the synthesis of drarmacidin A **21**, a cytotoxic bis(indole) piperazine alkaloid from deep water marine sponge, Jiang studied the reduction of compound **20**, obtained in few steps from (*S*)-6-bromo-

indolyglycinol **16** (Scheme 7).¹⁶ NaBH₄ reduction of the imine function of **19** furnished an 82:17% mixture of the two isomers which could be separated. The minor isomer **20** was then deprotected (L-Selectride), then reduced (BH₃.THF) providing *trans* natural isomer in 42% yield and optically pure form.

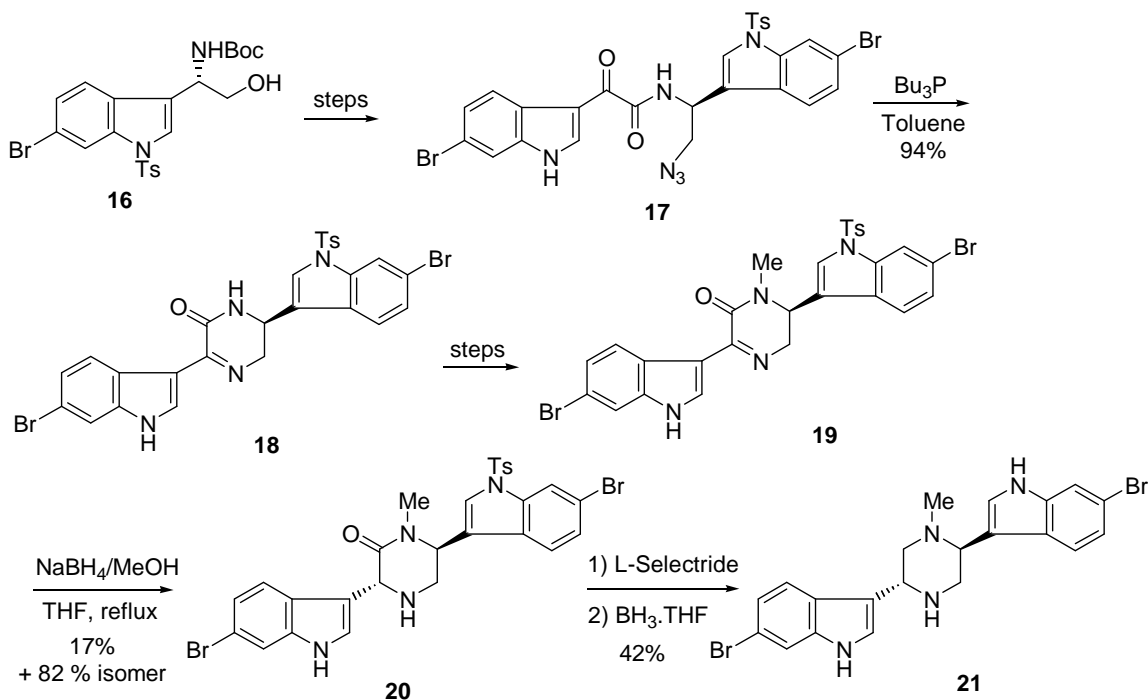

Scheme 7

Pichlmair and Jordis described the synthesis of cocaine analogues possessing a bridged bicyclic piperazine skeleton (Scheme 8).¹⁷ Hydrogenation of nitroacetate **23** resulted in cyclization of the intermediate to the methyl 3,8-diaza-bicyclo[3.2.1]octane-2-carboxylate as a mixture of the equatorial and axial products. Major isomer **24** was then selectively reduced providing compound **25** in 76% yield.

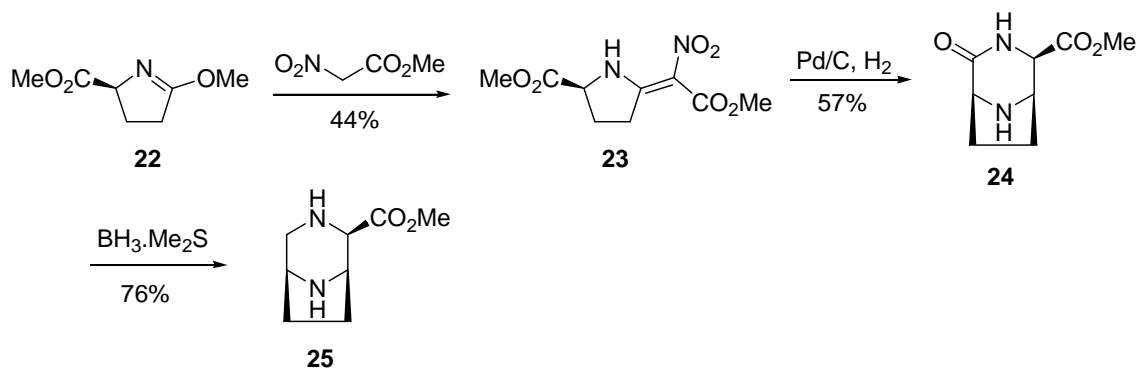

Scheme 8

All the previously described methods and those presented in the next Section are generally limited by the use of natural aminoacids. Our group described the diastereoselective alkylation of lactam **28** obtained in six steps from (*R*)-phenylglycinol **26** (Scheme 9). After treatment with *t*-BuLi and addition of an electrophile, alkylated products **30a–c** were obtained as a mixture of diastereomeric compounds (*de* > 90%), easily separable by flash chromatography.¹⁸ These lactams can be reduced (BH₃.THF) and then deprotected

(TFA) leading to optically pure substituted monosubstituted piperazines which were hydrogenolized to furnish optically pure monosubstituted piperazines **31a-c**. The origin of diastereoselectivity in the alkylation step of lactam **28** was explained by a rigid intermediate **29** in which the pyramidalized amide nitrogen chelated the alkoxide lithium cation.¹⁹

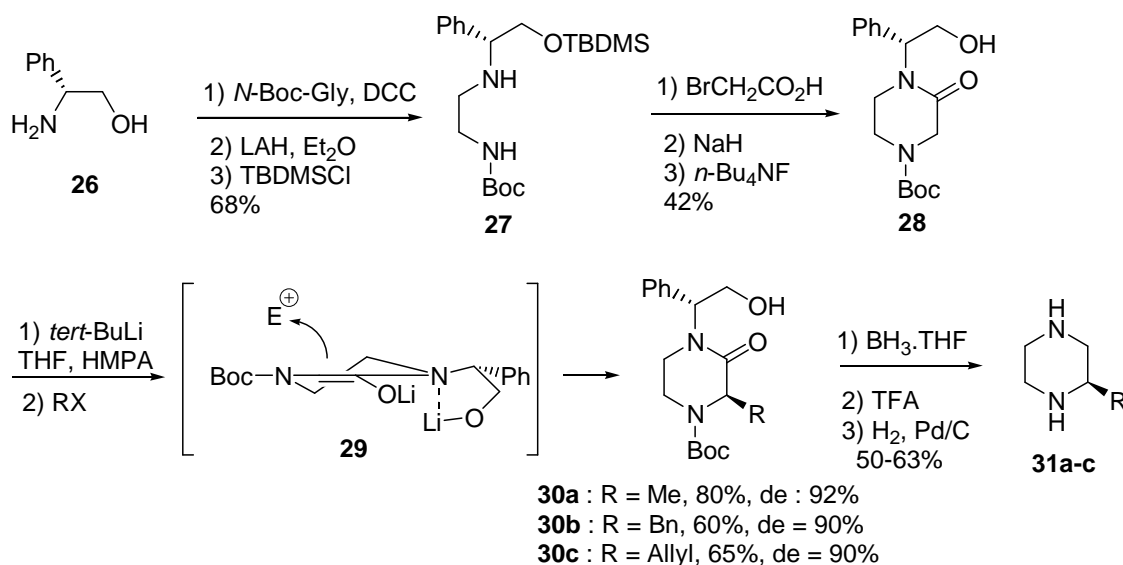

Scheme 9

3.2. Reduction of 2,3-diketopiperazines

During the synthesis of chiral substituted DABCO, Hirama reported the preparation of 2,3-disubstituted piperazine **35**, by condensation of diamine **33** with ethyl oxalate, followed by LiAlH_4 reduction of the resulting 2,3-diketopiperazine **34** in 27% yield from **32** (Scheme 10).²⁰ This piperazine was then condensed with 1,2-dibromoethane furnishing the desired DABCO derivative **36**.

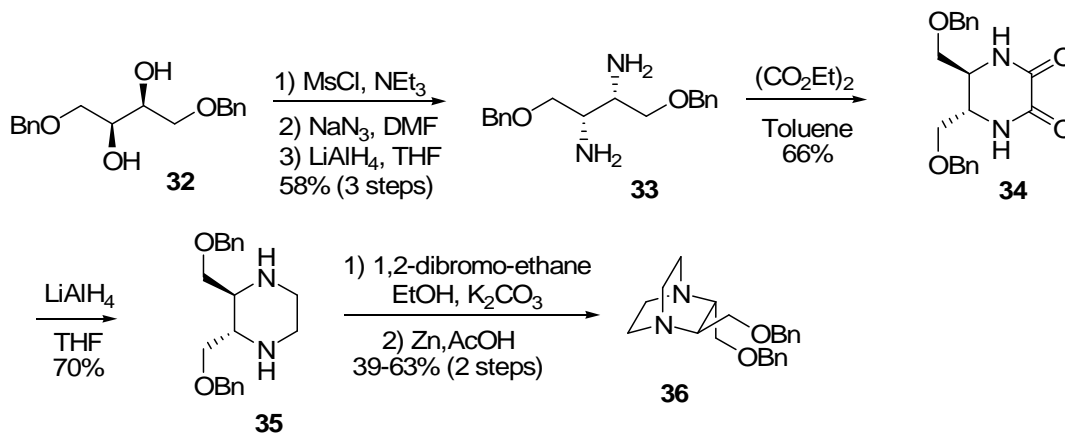

Scheme 10

Optically pure *N*-sulfinyl-*N*-benzyldiaminoalcohols **40** are readily available through the diastereoselective condensation between *p*-toluenesulfinimines **37** and glycine iminoester enolates **38**, followed by reductive cleavage (Scheme 11). Enantiopure 2,3-disubstituted piperazines **42** have been synthesized in good overall yields by treatment of **40** with diethyl oxalate and sodium methoxide leading to the corresponding 2,3-diketopiperazines **41**, which were submitted to borane reduction.²¹

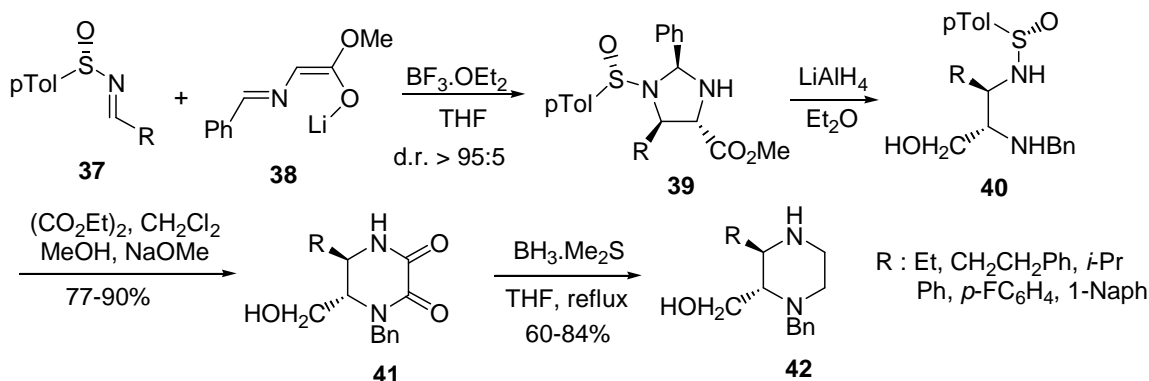

Interestingly, in the same paper, authors described the nucleophilic additions to imino ketopiperazines **46**, readily available from diaminoalcohols **40** (Scheme 12). Diastereoselectivity was highly nucleophile dependent. Best results were obtained using cerium salt under Barbier conditions. Reduction of these ketopiperazines could furnish a simple access to 2,3,5-trisubstituted piperazines.

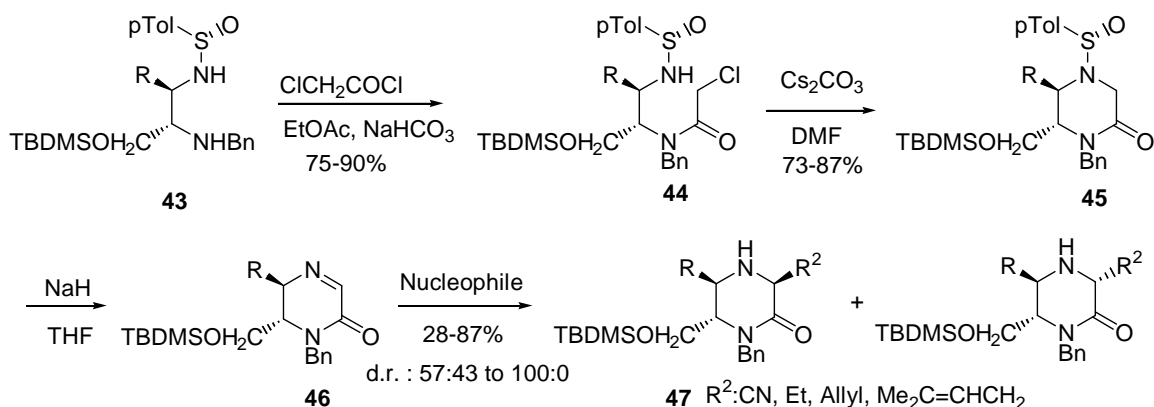

3.3. Reduction of 2,5-diketopiperazines

A detailed method involving the reduction of diketopiperazines synthesized by cyclodimerization of aminoacids has been described in a paper relating the synthesis of different optically pure substituted piperazines (Scheme 13).²²

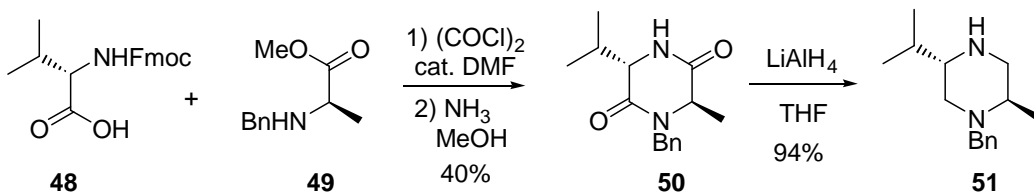

$\text{NaBH}_4/\text{BF}_3\cdot\text{OEt}_2$ has been also used to reduce 2,5-diketopiperazine **55** in 75% yield during the preparation of HIV-1 inhibitors (Scheme 14).²³

5-Alkylpiperazine-2-carboxylic acids **64** have also been obtained *via* the reduction of diketopiperazines **60**.²⁴ The final steps of the synthesis required protection of the two nitrogens prior to oxidation then deprotection (Scheme 15).

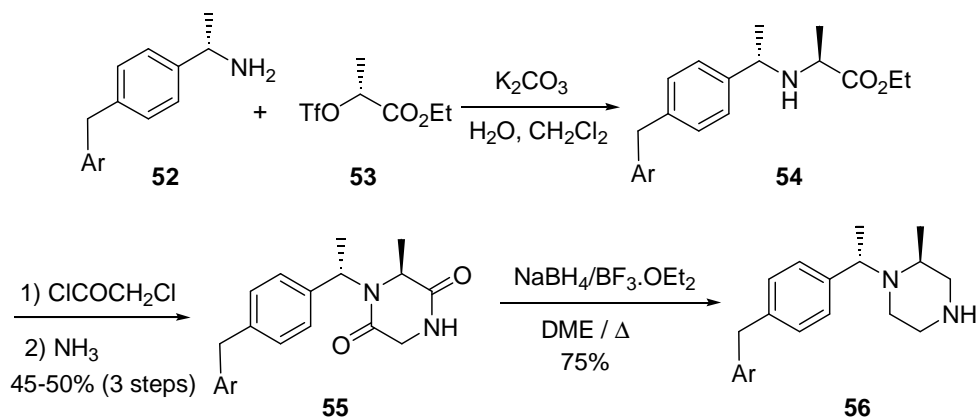

Scheme 14

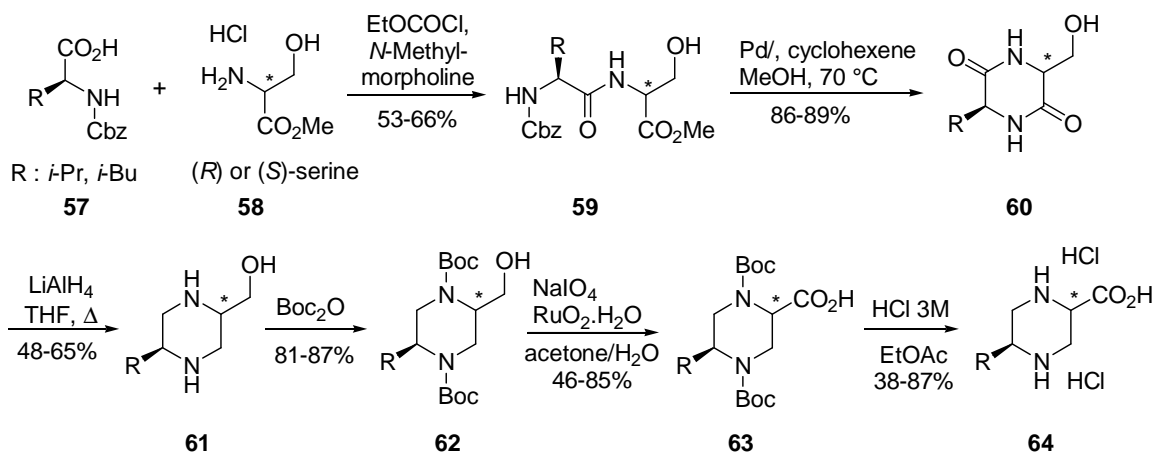

Scheme 15

In a series of papers describing the synthesis of ligands for central nervous system receptors,²⁵ Wunsch presented the syntheses of functionalized hydroxymethyl and hydroxyethyl piperazines **68** and **70** starting from (*R*) or (*S*)-serine **58** and (*2S,3R*)-threonine **69** (Scheme 16). The feature of this strategy is the simultaneous protection of both the amino and hydroxyl-moiety of serine with benzaldehyde and the direct formation of *N*-protected products after the reduction step.

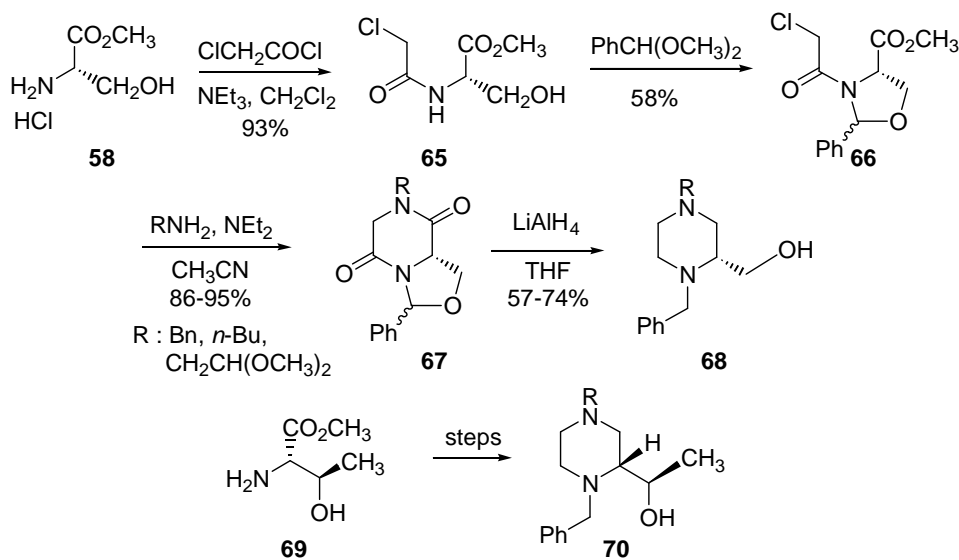

Scheme 16

4. Reduction of tetrahydropyrazines

4.1. Reduction of chiral tetrahydropyrazines

Monosubstituted piperazine **74** is an intermediate for the preparation of PAF antagonists.²⁶ The asymmetric synthesis involved the preparation of aziridine **71** from serine which was then selectively opened by nucleophilic attack of a functionalized amine. The acylated derivative **72** was cyclized with catalytic amounts of *p*-toluenesulfonic acid, hydrogenation on Pd/C furnished optically pure aminoalcohol **74**.

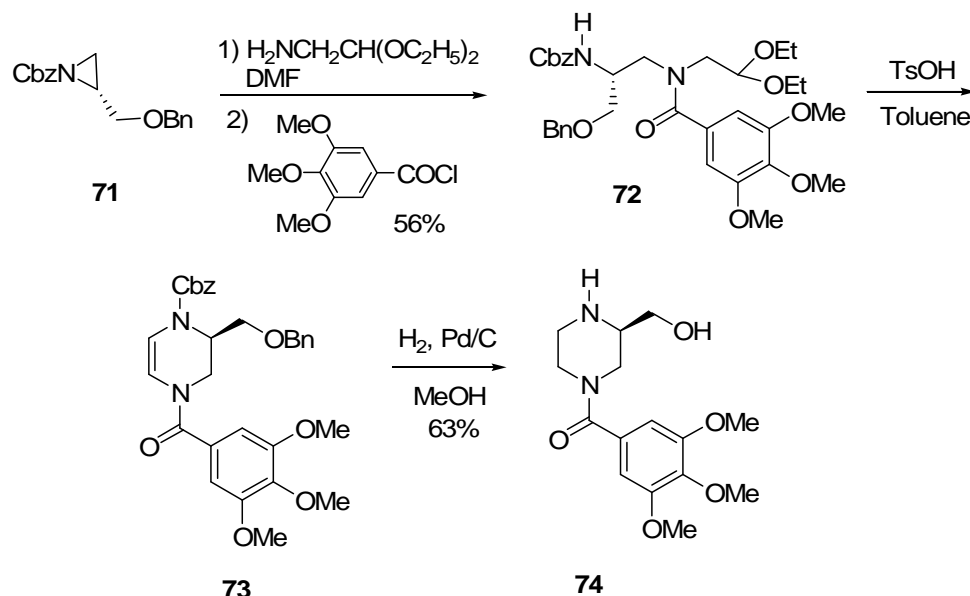

Scheme 17

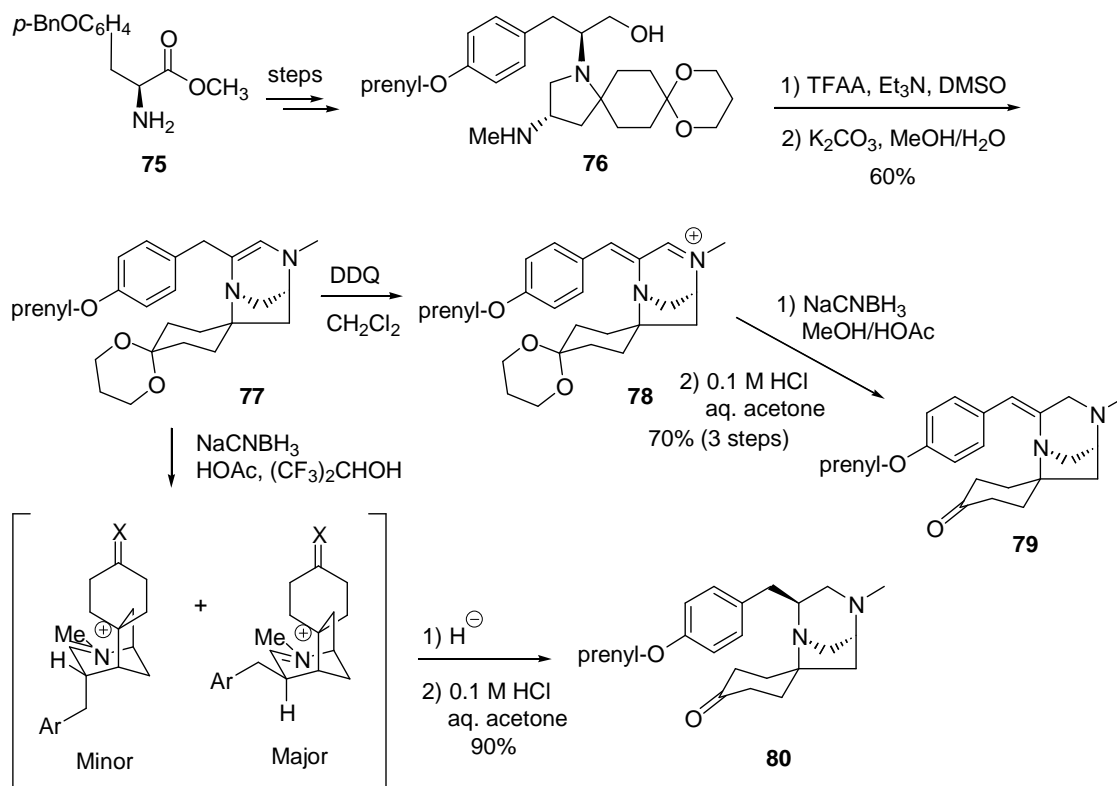

Scheme 18

During the synthesis of muscarinic antagonists, Snider described the preparation of the bicyclic tetrahydropyrazines **79** and **80** by cyclization of an aminoketone prepared in few steps from O-benzyl tyrosine methyl ester (Scheme 18).²⁷ Isomerisation of the double bond has been realized in a two step procedure involving oxidation with DDQ then NaCNBH₃ reduction, leading to TAN1251B **79** after hydrolysis of the ketal. The synthesis of TAN1251D **80**, the reduced form of **79**, was diastereoselectively accomplished by reduction with NaCNBH₃ in a more acidic solvent: (CF₃)₂CHOH. The stereochemical control in the reduction of **77** occurred in the protonation step, which gave a mixture of iminium salts. Protonation should occur from the less hindered axial face to give iminium salt with an equatorial benzyl group which furnished piperazine **80** after reduction.

4.2. Asymmetric hydrogenation of tetrahydropyrazines

During the course of preparation of Crixivan ® piperazine intermediate, different methods of asymmetric hydrogenation of tetrahydropyrazines have been reported. Results are highly substrate and condition dependent. The Merck research group first reported synthesis of optically active piperazine **82** in 96% yield and 99% ee by asymmetric hydrogenation of carboxamide **81** catalyzed by [(*R*)-BINAP(COD)Rh]TfO.²⁸ Removal of the Cbz group, followed by crystallization, gave **83** in optically pure form (Scheme 19).

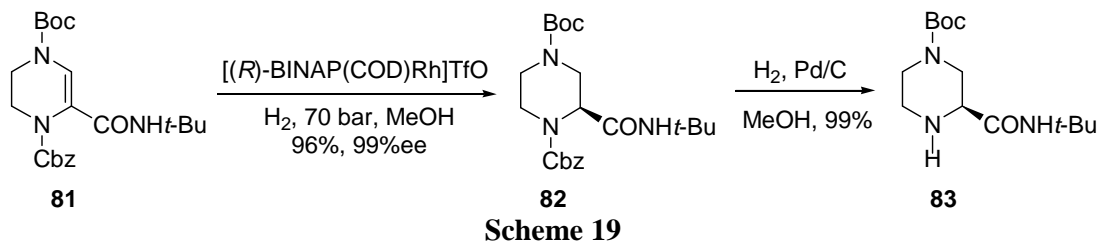

Asymmetric hydrogenation of *N*-acyl dehydroaminoacid **86**, prepared by cyclization of Ugi adduct **84** led to complete conversion and high enantioselectivity (97% ee) using the same catalyst at 100 atm H₂ pressure at 40 °C in MeOH (Scheme 20).²⁹ Subsequent formamide deprotection was carried out without concomitant racemization heating **87** with 35% aqueous hydrazine.

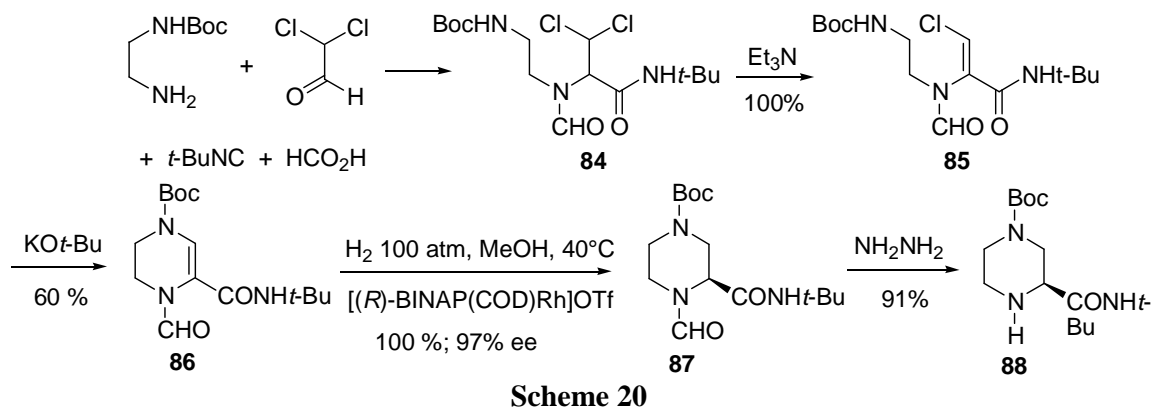

Asymmetric hydrogenation of carboxylate **88** was achieved using [2.2]PHANEPHOS RhOTf, a planar chiral bisphosphine ligand, in high enantioselectivity under mild conditions leading to **89** in quantitative yield.³⁰

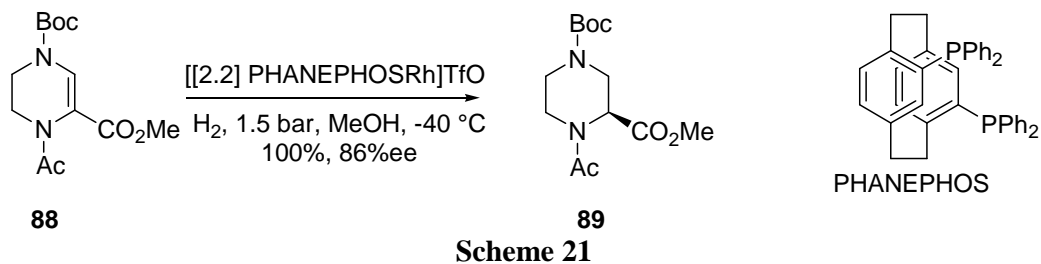

More recently, Ito described the use of another chiral ferrocene diphosphine-rhodium complex leading to optically pure **91** under mild conditions (1,2-dichloroethane, 50 °C, 1 bar) and with excellent enantioselectivity (Scheme 22).³¹

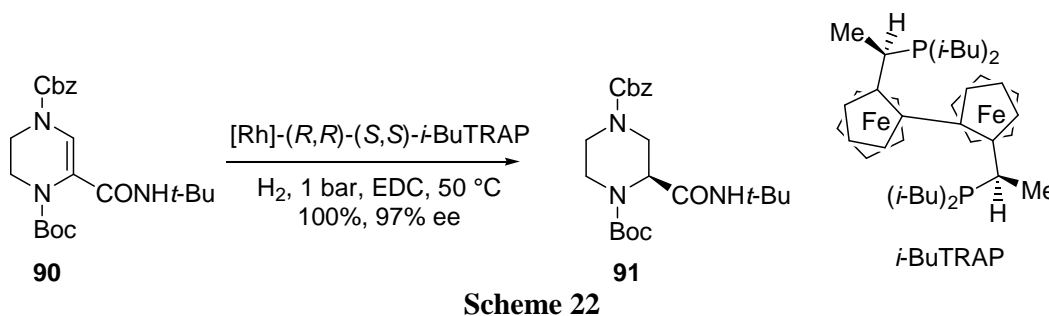

5. Reductive cyclization of diamines

5.1. Diastereoselective cyclization

2,3-Disubstituted piperazines have been prepared *via* reductive cyclization of diamines (Scheme 23). However this method is limited to the preparation of compounds possessing the same substituents on the piperazine ring.

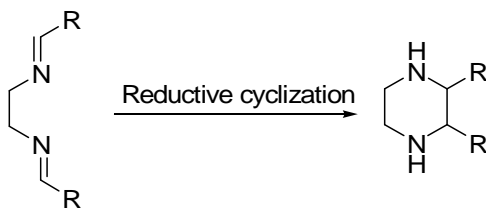

A first diastereoselective version has been described by Sigman using (*R,R*)-cyclohexyldiamine derived diimine **92**.³² Treating this diimine with Mn(0) in the presence of 3 equiv. of TFA, a single diastereomer **93** was obtained in quantitative yield (Scheme 24).

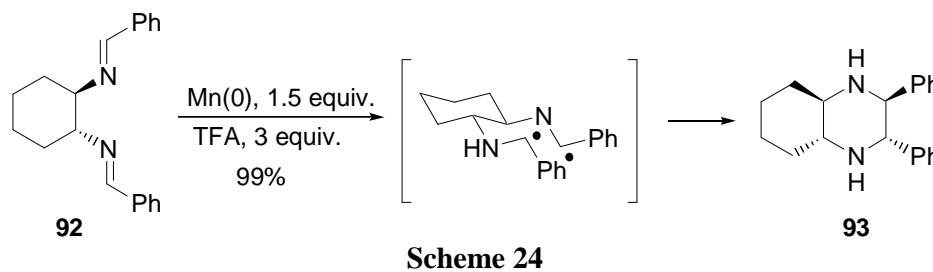

The diastereoselectivity has been explained through the intramolecular cyclization of a diradical in which the substituents are oriented *trans* to each other in equatorial positions. Similar results have been further described using low-valent titanium species prepared using the TiCl₄/Et₃N or TiCl₄/Mg reagent systems and different diimines.³³

5.2. Enantioselective cyclization

More recently, the same authors described an enantioselective version of this reaction using chiral titanium complex.³⁴ Moderate to high enantiomeric excess (50–97%) have been observed depending of the nature of the titanium complex and the imine substituents (Scheme 25).

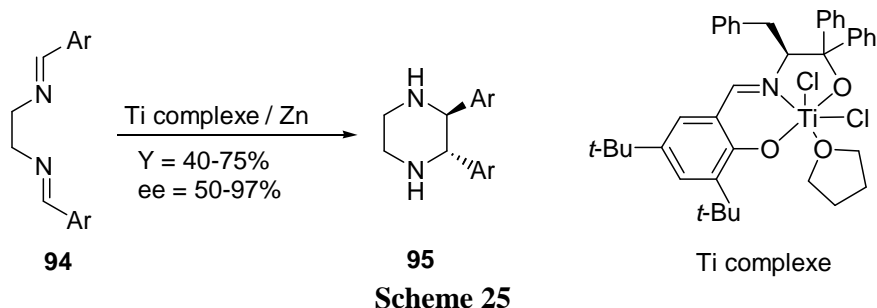

6. Cyclization of diaminoalcohols

The preparation of a piperazine ring following the intramolecular Mitsunobu reaction of aminoalcohols has first been described by Upjohn chemists for the synthesis of anxiolytic agents.¹⁵ 2-Methyl and 2,6-dimethyl piperazines **101** and **104** were prepared *via* two different strategies. In the first one (Scheme 26), Mitsunobu reaction was conducted with an amide derivative **97**, whereas in the second one (Scheme 27), a diamine compound **103** was used for the cyclization.

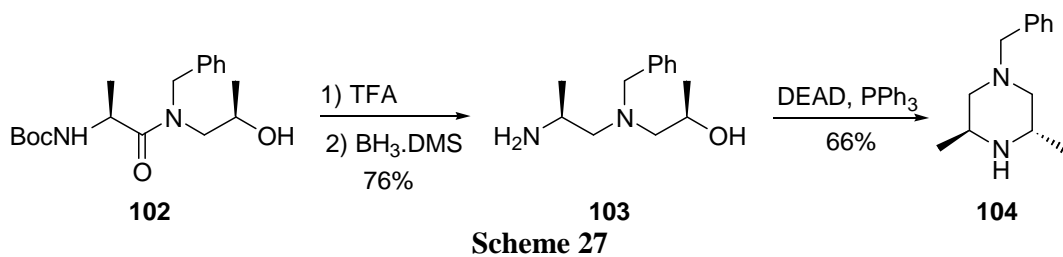
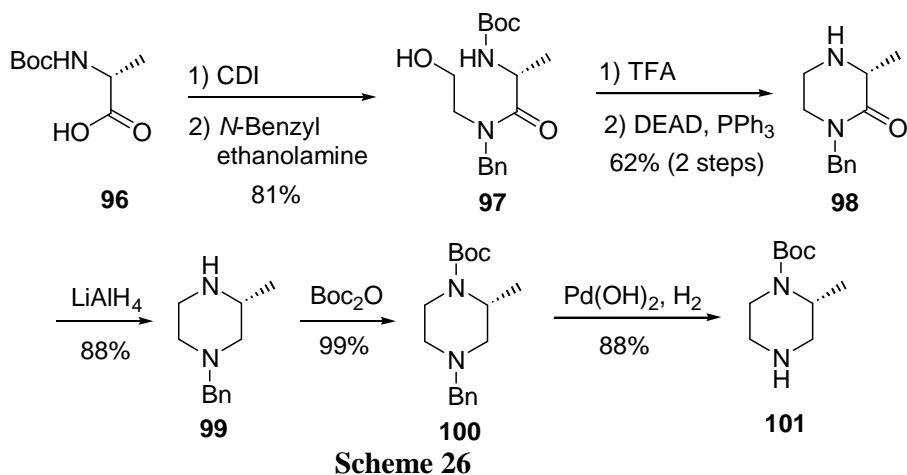

The same strategy has been further used to prepare carboxylic acid derivatives (Scheme 28).³⁵ Key intermediate **107** was prepared in 7 steps from D-threonine *via* aziridine **106** which was regioselectively opened by reaction with 2-aminoethanol. Classical Mitsunobu conditions afforded piperazine **108** in 65% yield from aminaolcohol **107**.

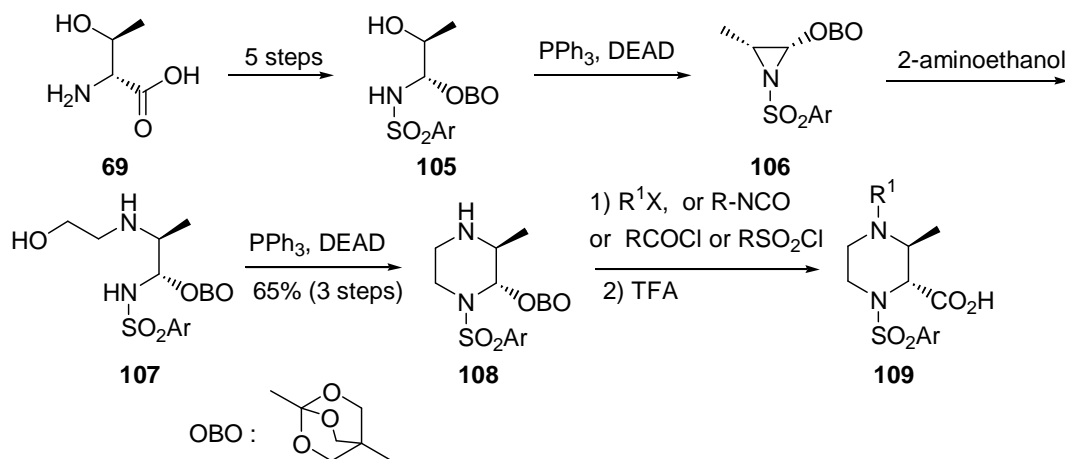

7. Cyclization of diamines

7.1. Nucleophilic substitution

Direct cyclization of chiral diamines generally leads to low yield of piperazine due to the formation of cross-linked derivatives. Best results have been observed with intramolecular cyclization or with slow addition of reactive dielectrophiles.

Bicyclic piperazines **112** have been prepared in a one-pot procedure from the corresponding chloroaldehyde **110** (Scheme 29).³⁶ Reductive amination furnished an amine which spontaneously cyclized to furnish a bicyclic piperazine.

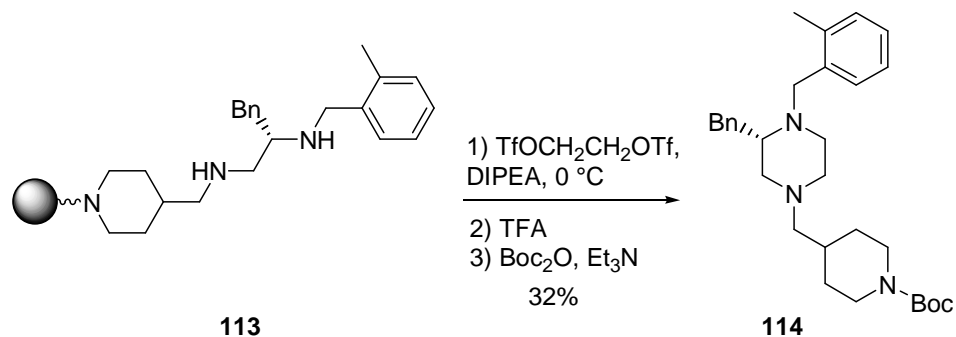
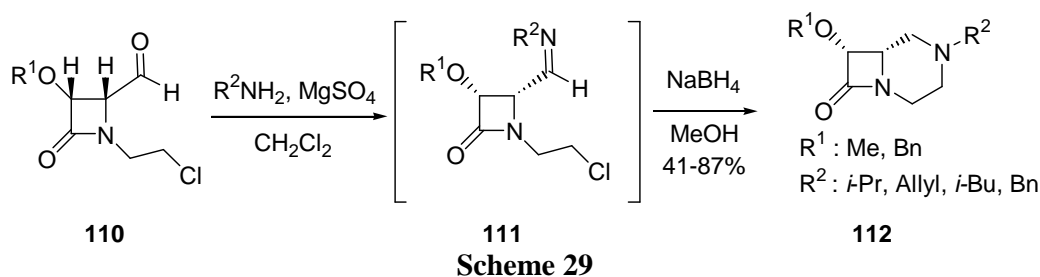

Resin-bound diamine **113** was cyclized under mild conditions (TfOCH₂CH₂OTf, DIPEA, CH₂Cl₂, 0 °C) leading to a piperazine which was further cleaved, then protected affording pure **114** (Scheme 30).³⁷

7.2. Reductive amination

Chiral 1,2-diamines **117** have been obtained by ring opening of aziridines **115** followed by selective *N* terminal alkylation (Scheme 31). Their reductive cyclization with 40% aqueous glyoxal solution in the presence of NaBH₃CN in MeOH at 0 °C proceeded smoothly furnishing the desired 2-substituted piperazines **118** in high yield.³⁸

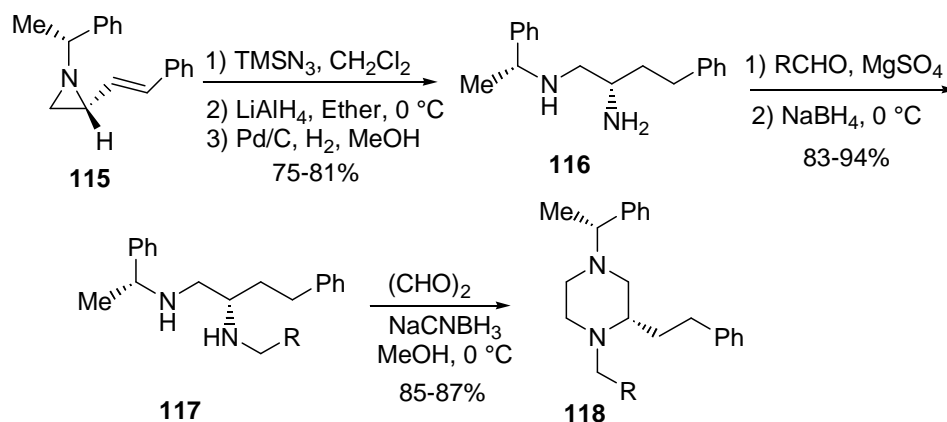

When (*R*)-phenylglycinol **119** was treated with glyoxal, oxazino-oxazine **120** was obtained as a single isomer in 70% yield (Scheme 32).

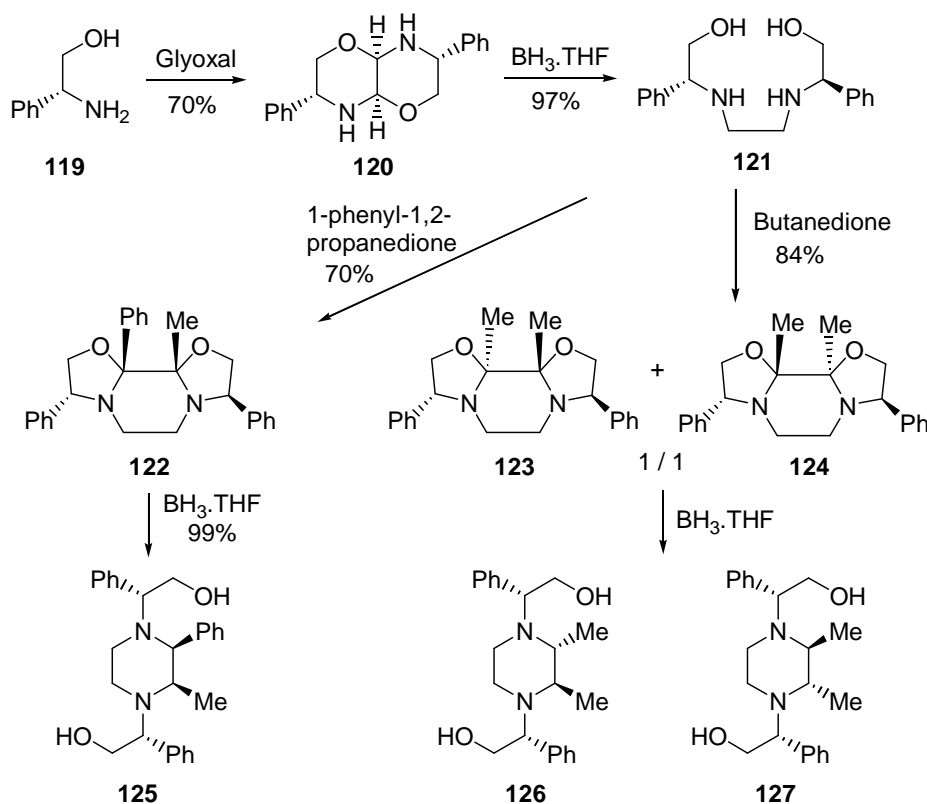

Reduction with BH_3 .THF afforded hydroxyethylenediamine **121** which was reacted with 1-phenyl-1,2-propanedione or butanedione then reduced to provide optically pure *trans* and *cis* 2,3-disubstituted piperazines **125–127**.³⁹ The different diastereoselectivities observed were explained by steric repulsion due to the presence of the aromatic ring in the first example.

An efficient asymmetric synthesis of orthogonally protected (*S*)-piperazine-2-carboxylic acid **132** has been described utilizing an extension of Vedera's serine lactone ring opening (Scheme 33). Ozonolysis of the resulting *N*-allyl aminoacid **130** led to an aldehyde which spontaneously cyclized furnishing aiminal intermediate **131**.⁴⁰ Protected (*S*)-piperazine-2-carboxylic acid was then obtained by chemoselective reduction of the aiminal.

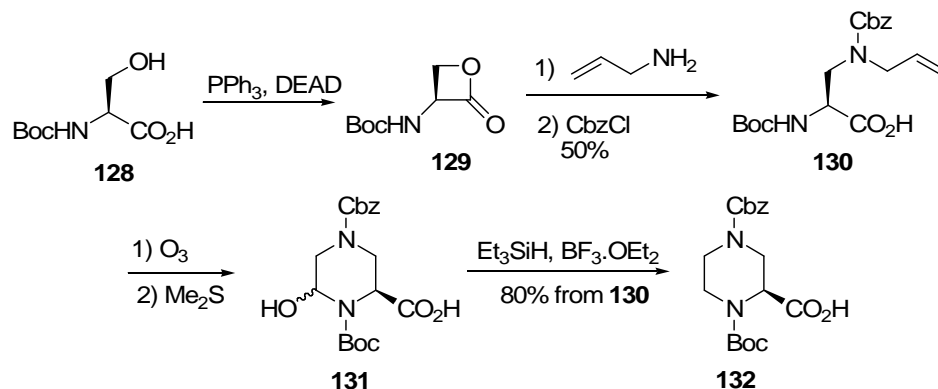

Scheme 33

7.3. Allylic substitution

Palladium-catalyzed tandem asymmetric allylic substitution of 1,4-diacetoxy-2-butene using a 1,2-diamine as a nucleophile is a useful method for the synthesis of 2-vinyl-piperazines **135** (Scheme 34). Since the first report of this reaction by Hayashi, different catalysts have been utilized in this reaction.⁴¹ The best results (88% yield and 86% ee) have been obtained using di-*i*-propoxycarbonyl butene, dibenzylamine and a phosphinophenylpyridine **137** as chiral ligand.^{41d}

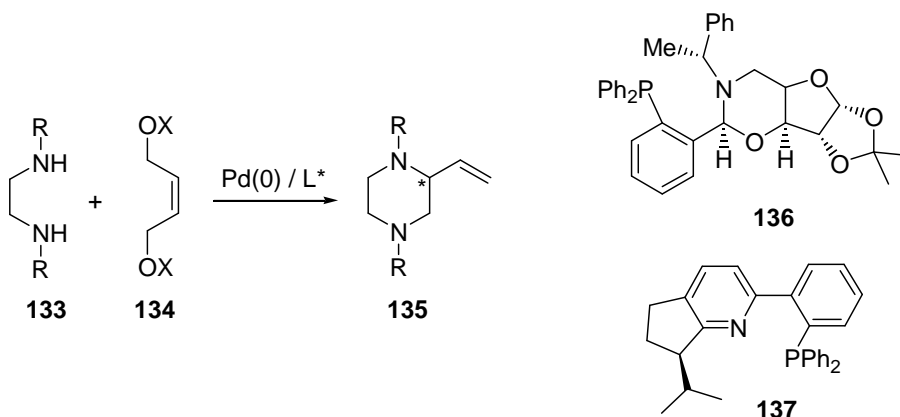

R	X	L*	Yield (%)	ee (%)	Ref.
Ts	C(=O)OMe	(<i>R</i>)-BINAP	74	60	41a
Bn	Ac	BHMP	65	42	41b
Bn	Ac	136	50	70	41c
Bn	C(=O) <i>Oi</i> -Pr	137	88	86	41d

Scheme 34

8. Amination and carboamination of olefins

A concise asymmetric synthesis of *cis*-2,6-disubstituted piperazines **143** from aminoacid derivatives has been published (Scheme 35).⁴² The key step is a Pd-catalyzed carboamination of an *N*-allyl-diamine **142** with an aryl bromide.

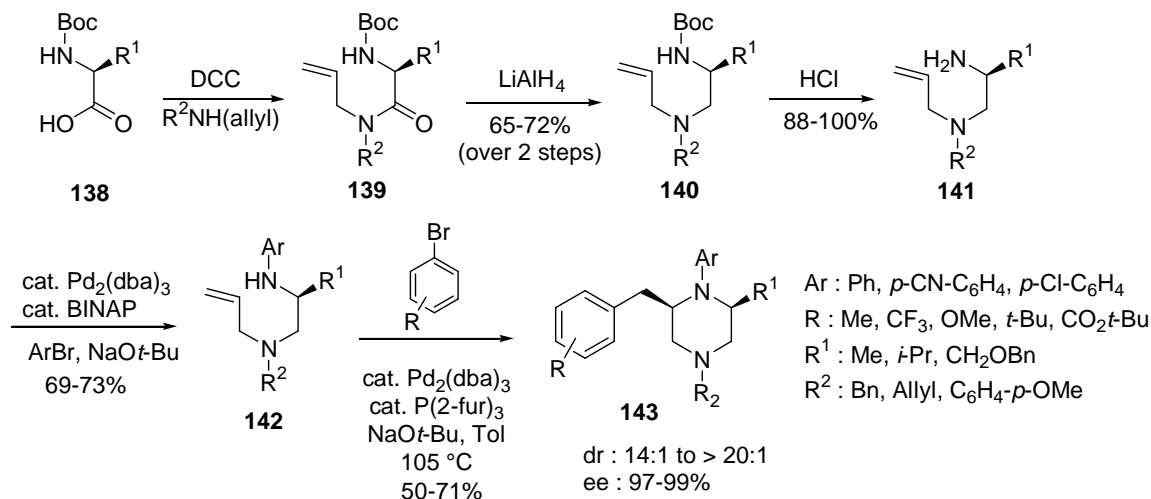

Scheme 35

The stereochemical outcome of the piperazine-forming reaction was explained *via* a transition state in which the N1-Ar group is rotated such that N1 is pyramidalized (Scheme 36). This allows pseudoequatorial orientation of R¹, which leads to the *cis*-2,6-disubstituted piperazines.

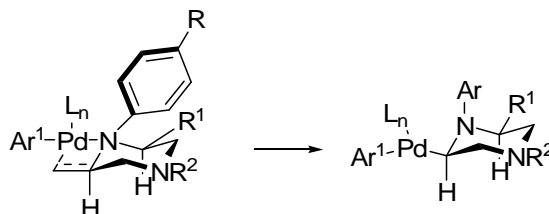

Scheme 36

More recently, a diastereoselective intramolecular hydroamination has been developed for a modular *trans*-2,6-disubstituted piperazine synthesis using Pd-catalyst **147**.⁴³ Starting aminoalkenes **145** were prepared from optically pure cyclic sulfamidates **144** (Scheme 37).

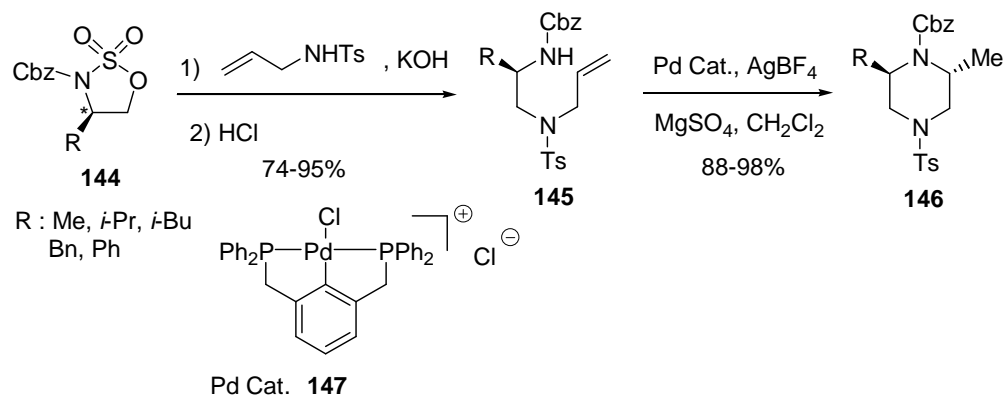

Scheme 37

Hydroamination was realized in the presence of 5 mol % of catalyst and 10 mol % of AgBF₄ in CH₂Cl₂ leading to piperazines **146** in excellent yields (88–98%) and diastereoselectivities.

Diastereoselectivity was explained by a chairlike transition state in which the substituent in the 2-position adopted a pseudoaxial orientation to avoid allylic strain, cyclization occurred with the alkenyl group in a pseudo-equatorial position, leading to selective formation of the *trans* diastereomer.

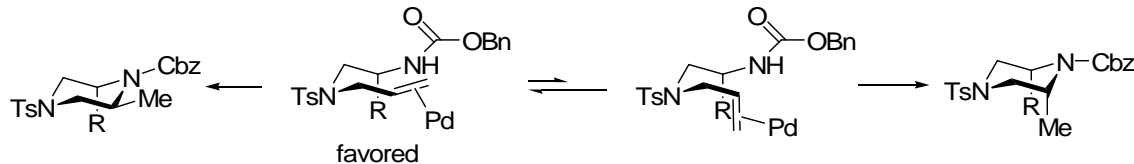

9. Direct functionalization of substituted piperazines

9.1. Selective alkylation of substituted piperazines

Our group described the diastereoselective alkylation of 2-keto-piperazines.¹⁸ In a further article, we presented the synthesis of 2,6-disubstituted piperazines **150** from previously synthesized monosubstituted piperazines **30**.⁴⁴ The method was based on diastereoselective alkylation of the resulting carbamates, after selective reduction of the lactam and methylation of the alcohol, *via* a metallation process as described by Beak.⁴⁵ Different electrophiles were reacted to furnish only *trans*-2,6-substituted products **149**. Particularly attractive was the possibility of obtaining access to new aminoacids in enantiomerically pure form (**150**, E=CO₂H).

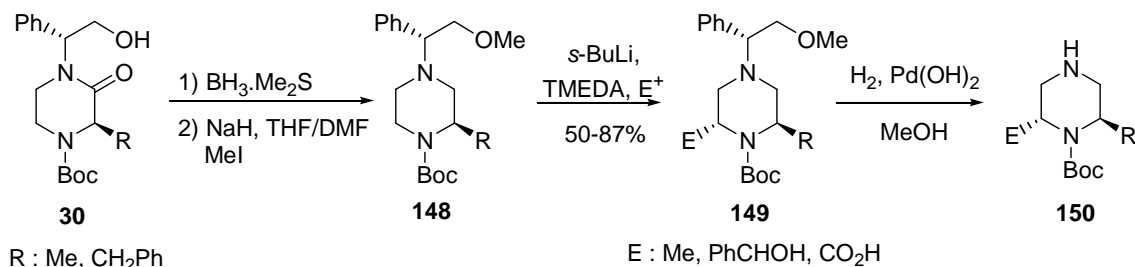

9.2. N-Selective functionalization

Orthogonal protection of the two piperazine nitrogens is often required during the synthesis of substituted piperazine containing derivatives and as scaffolds for the construction of combinatorial libraries. Some articles described the specific preparation of orthogonally protected derivatives of piperazine-2-carboxylic acid. Bigge has been the first to report an orthogonally protected derivative bearing benzyloxycarbonyl and *tert*-butoxycarbonyl protecting groups in the racemic series (Scheme 40).⁴⁶ In a first experiment, copper chelation was chosen to protect the α -aminoacid moiety and allow the selective alkylation of the free nitrogen.

This strategy has been further used with optically pure 2-piperazine carboxylic acid to protect the α -aminoacid moiety and allow the regiospecific protection of N⁴ (Scheme 41).⁴⁷

An alternative approach was taken to allow the preparation of N-1 and N-4 protected piperazines. Treatment of 2-piperazinecarboxylic acid with Boc-ON in dioxane, selectively furnished monoprotected

derivative **154** which was further reacted with benzylchloroformate leading to diprotected compound **155**. After formation of the methyl ester, N-Boc group was removed quantitatively by treatment with TFA.

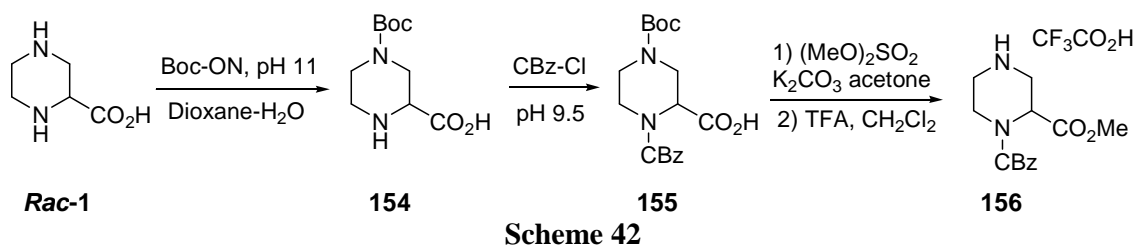
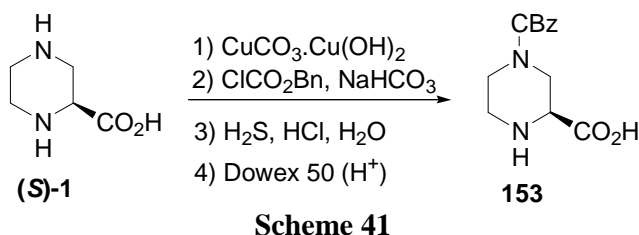
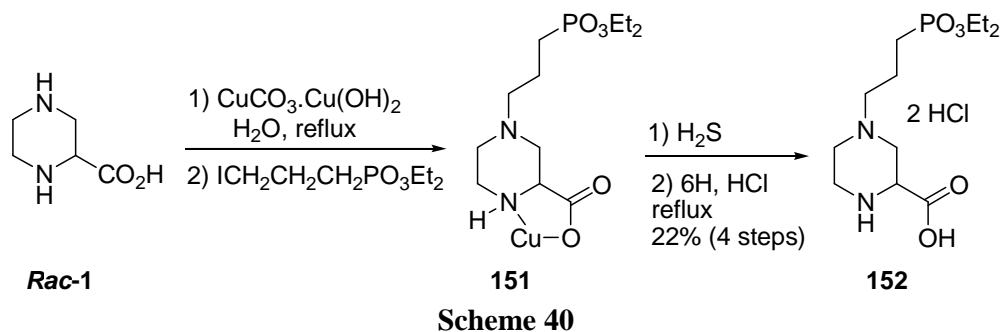

An interesting example of selective protection has been recently described during the preparation of peptide helix mimetics incorporating chiral piperazines bearing hydrophobic side chains (Scheme 43).⁴⁸ Monosubstituted piperazines **158**, obtained by reduction of the corresponding diketo-piperazines **157**, were submitted to a series of protection and deprotection steps leading to mono and diprotected piperazines **159–162**.

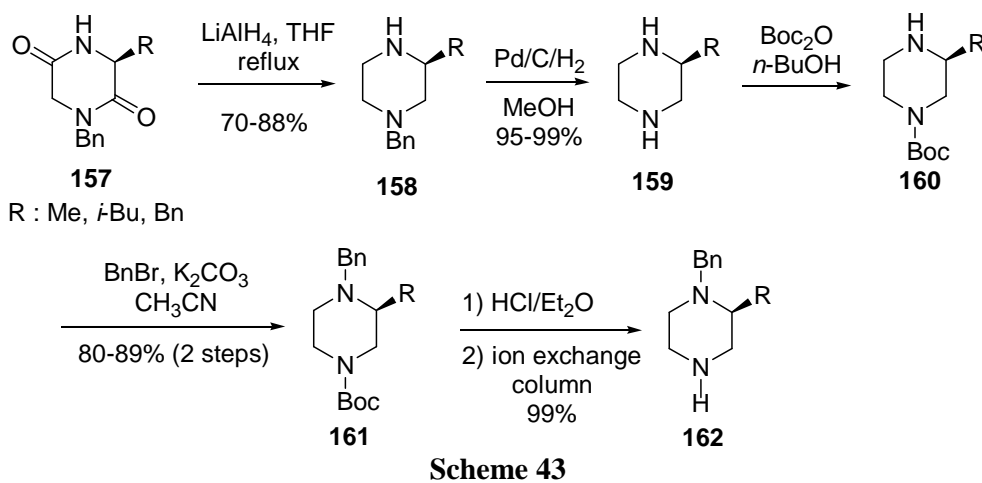

In their paper dealing with the preparation of inhibitors of kinase, Novartis chemists presented the orthogonal protection of monosubstituted piperazines (Scheme 44).²² *N*-Benzyl, carbamates and *N*-acyl derivatives **164–167** can then be obtained by selective functionalization.

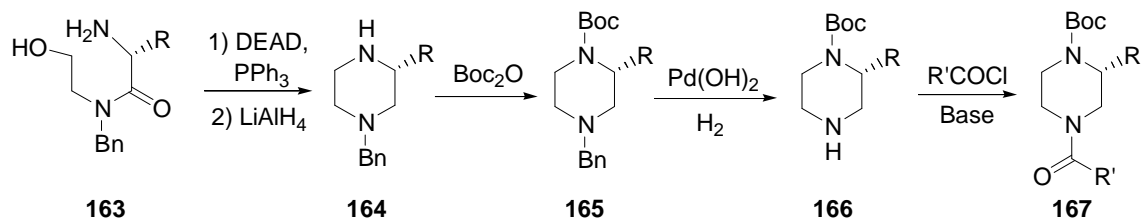

Scheme 44

More recently, two articles described the orthogonal protection of the same aminoacid and 2-(hydroxymethyl)piperazine.^{49,50} In the first article (Scheme 45), tetrahydro-1H-oxazolo[3,4-a]pyrazin-3(5*H*)-ones **169** served as orthogonally protected piperazines from which a variety of 2-substituted piperazines **172–174** can be prepared. Although this work has been realized in racemic series, it could be easily transposed in optically pure series.

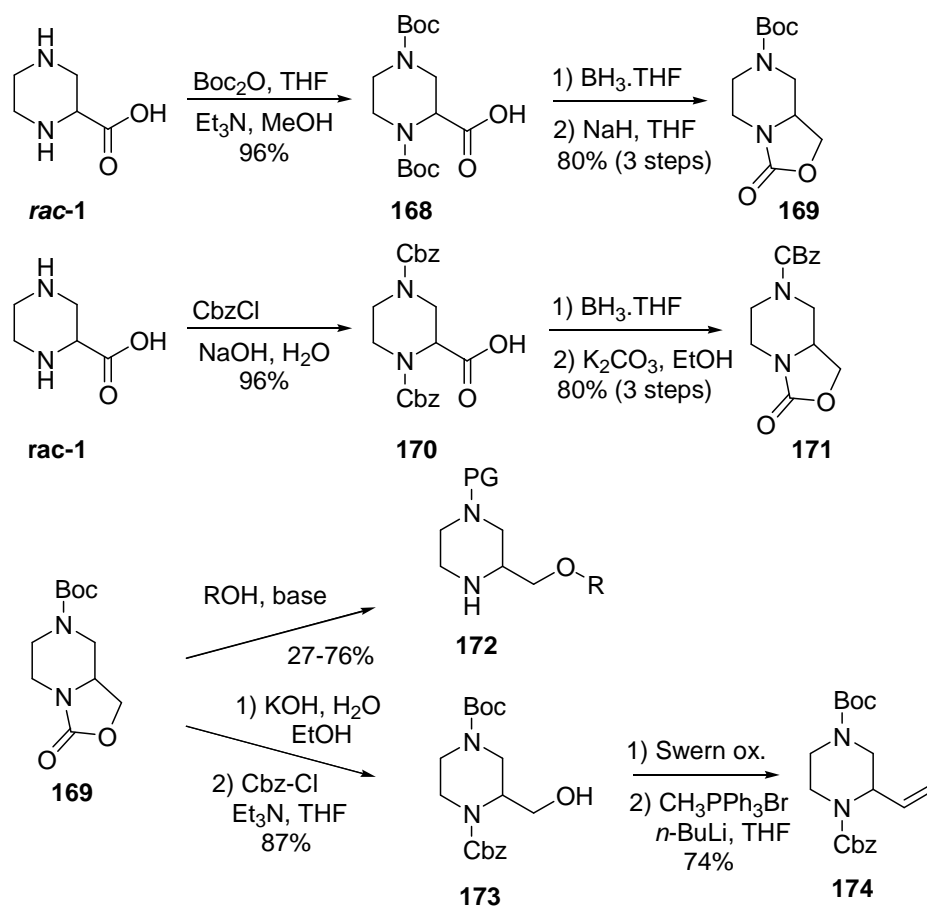

Scheme 45

In the second one (Scheme 46), a scalable synthesis of three differently protected 2-(hydroxymethyl)-piperazines **176–178** was presented starting from optically active (*S*)-piperazine-2-carboxylic acid dihydrochloride.

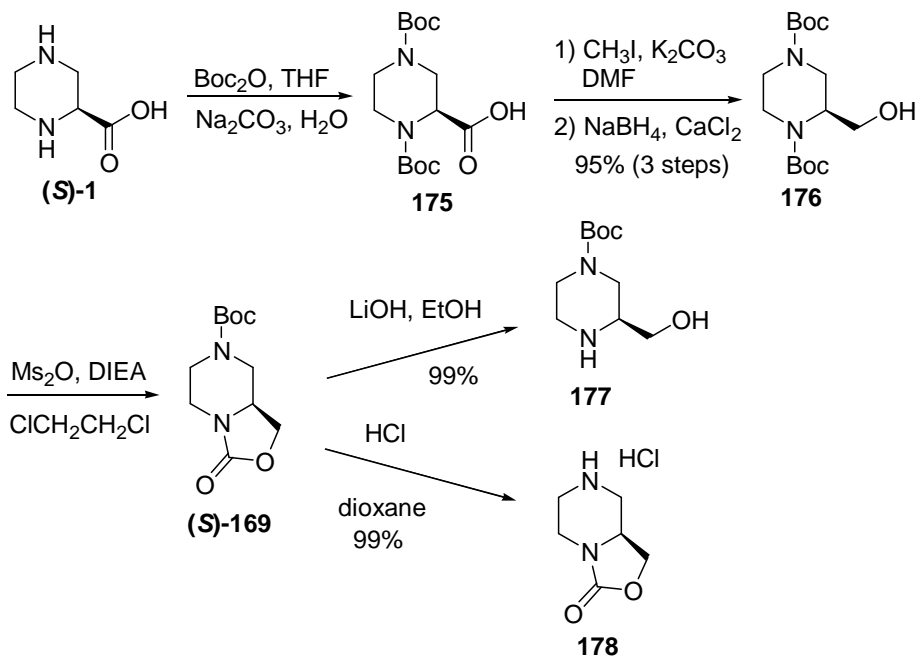

Scheme 46

10. Conclusions

The need for biologically active compounds continues to grow. Substituted piperazines remain important in drug discovery as they are found in several classes of active compounds. In addition, recent developments in asymmetric catalysis have made this class of compounds even more attractive. Most of the previously described methods involved starting materials from the chiral pool. There is still an important demand for new and improved methods to prepare optically pure compounds in this series, especially for functionalized substituted piperazines.

References

1. Nilsson, J. W.; Thorstensson, F.; Kvarnström, I.; Oprea, T.; Samuelsson, B.; Nilsson I. *J. Comb. Chem.* **2001**, *3*, 546–553.
2. Rossen, K.; Pye, P. J.; DiMichele, L. M.; Volante, R. P.; Reider, P. *Tetrahedron Lett.* **1998**, *39*, 6823–6826.
3. See, for examples: (a) Shono, T.; Kise, N.; Shirakawa, E.; Matsumoto, H.; Okazaki, E. *J. Org. Chem.* **1991**, *56*, 3063–3067. (b) Wang, Z.; Cheng, M.; Wu, P.; Wei, S.; Sun, J. *Org. Lett.* **2006**, *8*, 3045–3048.
4. Dinsmore, C. J.; Beshore, D. C. *Tetrahedron* **2002**, *58*, 3297–3312.
5. In order to simplify the presentation, the same numbering will be used for piperazines and ketopiperazines.
6. Felder, E.; Maffei, S.; Pietra, S.; Pitre, D. *Helv. Chim. Acta* **1960**, *43*, 888–896.
7. Stingl, K.; Kottenhan, M.; Drauz, K. *Tetrahedron: Asymmetry* **1997**, *8*, 979–982.
8. Rossen, K.; Askin, D.; Reider, P.; Varsolona, R. J.; Volante, R. PCT Int. Appl. **1995**, WO 9521162.
9. Lamouri, A.; Heymans, F.; Tavet, F.; Dive, G.; Batt, J.-P.; Blavet, N.; Braquet, P.; Godfroid, J.-J. *J. Med. Chem.* **1993**, *36*, 990–1000.
10. Bruce, M. A.; St. Laurent, D. R.; Poindexter, G. S.; Monkovic, I.; Huang, S.; Balasubramanian, N. *Synth. Commun.* **1995**, *25*, 2673–2684.
11. Komeda, H.; Harada, H.; Washika, S.; Sakamoto, T.; Ueda, M.; Asano, Y. *Eur. J. Biochem.* **2004**, *271*, 1580–1590.
12. Eichhorn, E.; Roduit, J.-P.; Shaw, N.; Heinzmann, K.; Kiener, A. *Tetrahedron: Asymmetry* **1997**, *8*, 2533–2536.

13. Aebischer, B.; Frey, P.; Haerter, H.-P.; Herrling, P. L.; Mueller, W.; Olverman, H. J.; Watkins, J. C. *Helv. Chim. Acta* **1989**, *72*, 1043–1051.
14. For a recent review on the synthesis of 2,5-dioxopiperazines, see: Dinsmore, C. J.; Beshore, D. C. *Tetrahedron* **2002**, *58*, 3297–3312.
15. (a) Mickelson, J. W.; Jacobsen, E. J. *Tetrahedron: Asymmetry* **1995**, *6*, 19–22. (b) Mickelson, J. W.; Belonga, K. L.; Jacobsen, E. J. *J. Org. Chem.* **1995**, *60*, 4177–4183.
16. Yang, C.-G.; Wang, J.; Tang, X.-X.; Jiang, B. *Tetrahedron: Asymmetry* **2002**, *13*, 383–384.
17. Pichlmair, S.; Mereiter, K.; Jordis, U. *Tetrahedron Lett.* **2004**, *45*, 1481–1483.
18. Schanen, V.; Riche, C.; Chiaroni, A.; Quirion, J.-C.; Husson, H.-P. *Tetrahedron Lett.* **1994**, *35*, 2533–2536.
19. Micouin, L.; Jullian, V.; Quirion, J.-C.; Husson, H.-P. *Tetrahedron: Asymmetry*, **1996**, *7*, 2839–2846.
20. Oishi, T.; Hiramata, M. *Tetrahedron Lett.* **1992**, *33*, 639–642.
21. (a) Viso, A.; Fernandez de la Pradilla, R.; Lopez-Rodriguez, M. L.; Garcia, A.; Tortosa, M. *Synlett* **2002**, 755–758. (b) Viso, A.; Fernandez de la Pradilla, R.; Flores, A.; Garcia, A.; Tortosa, M.; Lopez-Rodriguez, M. L. *J. Org. Chem.* **2006**, *71*, 1442–1448.
22. Aicher, T. D.; Anderson, R. C.; Gao, J.; Shetty, S. S.; Coppola, G. M.; Stanton, J. L.; Knorr, D. C.; Sperbeck, D. M.; Brand, L. J.; Vinluan, C. C.; Kaplan, E. L.; Dragland, C. J.; Tomaselli, H. C.; Islam, A.; Lozito, R. J.; Liu, X.; Maniara, W. M.; Fillers, W. S.; DelGrande, D.; Walter, R. E.; Mann, W. R. *J. Med. Chem.* **2000**, *43*, 236–249.
23. Tagat, J. R.; McCombie, S. W.; Steensma, R. W.; Lin, S.-I.; Nazareno, D. V.; Baroudy, B.; Vantuno, N.; Xu, S.; Liu, J. *Bioorg. Med. Chem. Lett.* **2001**, *11*, 2143–2146.
24. Falorni, M.; Giacomelli, G.; Satta, M.; Cossu, S. *Synthesis* **1994**, 391–395.
25. (a) Soukara, S.; Wunsch, B. *Synthesis* **1999**, 1739–1746. (b) Bedürftig, S.; Weigl, M.; Wunsch, B. *Tetrahedron: Asymmetry* **2001**, *12*, 1293–1302. (c) Weigl, M.; Wunsch, B. *Tetrahedron* **2002**, *58*, 1173–1183.
26. Fukushi, H.; Mabushi, H.; Terashita, Z.; Nishikawa, K.; Suguhara, H. *Chem. Pharm. Bull.* **1994**, *42*, 551–559.
27. Snider, B. B.; Lin, H. *Org. Lett.* **2000**, *2*, 643–646.
28. Rossen, K.; Weissman, S. A.; Sager, J.; Reamer, R. A.; Askin, R. P.; Volante, R. P.; Reider, P. J. *Tetrahedron Lett.* **1995**, *36*, 6419–6422.
29. Rossen, K.; Pye, P. J.; DiMichele, L. M.; Volante, R. P.; Reider, P. J. *Tetrahedron Lett.* **1998**, *39*, 6823–6826.
30. Pye, P. J.; Rossen, K.; Reamer, R. A.; Tsou, N. N.; Volante, R. P.; Reider, P. J. *J. Am. Chem. Soc.* **1997**, *119*, 6207–6208.
31. (a) Kuwano, R.; Ito, Y. *J. Org. Chem.* **1999**, *64*, 1232–1237. (b) Kuwano, R.; Uemura, T.; Saitoh, M.; Ito, Y. *Tetrahedron: Asymmetry* **2004**, *15*, 2263–2271.
32. Mercer, G. J.; Sigman, M. S. *Org. Lett.* **2003**, *5*, 1591–1594.
33. Periasamy, M.; Srinivas, G.; Suresh, S. *Tetrahedron Lett.* **2001**, *42*, 7123–7125.
34. Vairaprakash, P.; Periasamy, M. *Tetrahedron Lett.* **2008**, *49*, 1233–1236.
35. Letavic, M. A.; Barberia, J. T.; Carty, T. J.; Hardink, J. R.; Liras, J.; Lopresti-Morrow, L. L.; Mitchell, P. G.; Noe, M. C.; Reeves, L. M.; Snow, S. L.; Stam, E. J.; Sweeney, F. J.; Vaughn, M. L.; Yu, C. H. *Bioorg. Med. Chem. Lett.* **2003**, *13*, 3243–3246.
36. Van Brabandt, W.; Vanwalleghem, M.; D’hooghe, M.; De Kimpe, N. *J. Org. Chem.* **2006**, *71*, 7083–7086.
37. Li, D.; Hall, D. G. *Tetrahedron: Asymmetry* **2005**, *16*, 1733–1736.
38. Lee, B. K.; Kim, M. S.; Hahm, H. S.; Kim, D. S.; Lee, W. K.; Ha, H.-J. *Tetrahedron* **2006**, *62*, 8393–8397.
39. Santes, V.; Gomez, E.; Zarate, V.; Santillan, R.; Farfan, N.; Rojas-Lima, S. *Tetrahedron: Asymmetry* **2001**, *12*, 241–247.
40. Warshawsky, A. M.; Patel, M. V.; Chen, T.-M. *J. Org. Chem.* **1997**, *62*, 6439–6440.
41. (a) Uozumi, Y.; Tanahashi, A.; Hayashi, T. *J. Org. Chem.* **1993**, *58*, 6826–6832. (b) Yamazaki, A.; Achiwa, K. *Tetrahedron: Asymmetry* **1995**, *6*, 1021–1024. (c) Nakano, H.; Yokoyama, J.; Fujita, R.;

- Hongo, H. *Tetrahedron Lett.* **2002**, *43*, 7761–7764. (d) Ito, K.; Imahayashi, Y.; Kuroda, T.; Eno, S.; Saito, B.; Katsuki, T. *Tetrahedron Lett.* **2004**, *45*, 7277–7281.
42. Nakhla, J. S.; Wolfe, J. P. *Org. Lett.* **2007**, *9*, 3279–3282.
 43. Cochran, B. M.; Michael, F. E. *Org. Lett.* **2008**, *10*, 329–332.
 44. Schanen, V.; Cherrier, V.; De Melo, S. J.; Quirion, J.-C.; Husson, H.-P. *Synthesis* **1996**, 833–837.
 45. Beak, P.; Zajdel, W. J.; Reitz, D. B. *Chem. Rev.* **1984**, *84*, 471–523.
 46. Bigge, C. F.; Hays, S. J.; Novak, P. M.; Drummond, J. T.; Johnson, G.; Bobovski, T. P. *Tetrahedron Lett.* **1989**, *30*, 5193–5196.
 47. Wu, M. T.; Ikeler, T. J.; Ashton, W. T.; Chang, R. S. L.; Lotti, V. J.; Greenlee, W. J. *Biorg. Med. Chem. Lett.* **1993**, *3*, 2023–2028.
 48. Maity, P.; König, B. *Org. Lett.* **2008**, *10*, 1473–1476.
 49. Clark, R. B.; Elbaum, D. *Tetrahedron* **2007**, *63*, 3057–3065.
 50. Gao, H.; Renslo, A. R. *J. Org. Chem.* **2007**, *72*, 8591–8592.

MICROWAVE ASSISTED SYNTHESIS OF FUNCTIONAL OLIGOTHIOPHENES

Manuela Melucci* and Giovanna Barbarella

Consiglio Nazionale delle Ricerche, Istituto per la Sintesi Organica e la Fotoreattività,
Via Piero Gobetti 101, I-40129 Bologna, Italy (e-mail: mmelucci@isof.cnr.it)

Abstract. *The increasing use of oligothiophenes in nano(bio)technology requires the preparation of large amounts of compounds with high and reproducible levels of purity. Therefore, the demand for practical, mild and efficient synthetic routes to oligothiophenes is continuously growing. This chapter describes two promising ‘enabling techniques’, namely microwave irradiation and solid phase catalysis and their combination, for the preparation of oligothiophenes with improved (opto)electronic functionalities. An innovative procedure, based on microwave assisted heterogeneous Pd catalysis is described. Such new, efficient and clean methodology smoothly afforded the preparation of oligothiophenes in high yields (up to 87% isolated yield, 30–100 minutes). The approach combining a very efficient reaction, i.e. the Suzuki Miyaura cross coupling, with improved catalyst separation, results more convenient and greener than any of the existing methodologies. Thieryl iodides or activated bromides can be employed as starting materials and KF as the base. The microwave reaction can be carried out in aqueous ethanol and the heterogeneous catalyst can be easily removed from the reaction mixture by filtration and reused in consecutive reactions (up to 4 times).*

Contents

1. Introduction
 - 1.1. Oligothiophenes scenario
 - 1.2. Ring-by ring growth through metal catalyzed cross-coupling reaction
 2. Solvent-free microwave assisted Suzuki coupling
 - 2.1. Unsubstituted quater- and quinquethiophene
 - 2.2. Self-affinity and electrical properties of **T5**
 - 2.3. Methyl substituted sexithiophene
 3. Liquid phase microwave assisted Suzuki coupling (less soluble oligomers)
 - 3.1. Rigid core thiophene co-oligomers with liquid crystalline properties
 4. Microwave assisted synthesis of oligothiophene semiconductors in aqueous media using silica and chitosan supported Pd catalysts
 - 4.1. Optimization of reaction conditions
 - 4.2. Extension to other substrates
 5. Conclusions
- References

1. Introduction

The twelve principles of green chemistry were first published 10 years ago and have formed the basis of a new direction in chemistry over the last decade.^{1,2} These principles outline the requirements for green processes and include key points such as the avoidance of toxic solvents, the use of catalysts, high atom

economy (*i.e.* addition reactions, where all the atoms in the reagents appear in the reaction product), low energy usage and process safety. Separation and recovery of catalysts in catalytic transformations is another aspect of catalytic reactions which has to be designed into processes. Protocols where separation, recovery/reuse of metal catalysts and minimization of by-products are simpler, are highly desirable in particular in material science owing to the need of preparing highly pure, metal free organic functional materials.

Oligo and polythiophenes are among the most used organic semiconducting and fluorescent materials for applications in devices such as field effect transistors (FET),³ light emitting diodes (LED),⁴ photovoltaic devices (PVD)⁵ and in biosensors.⁶ Their level of purity is intimately related to their functionality and final performance in devices. Therefore, the demand for practical, mild and selective synthetic routes to oligothiophenes is still growing.

This chapter describes a new synthetic methodology based on two *enabling techniques*,⁷ *i.e.* microwave assistance and solid phase Pd catalysis, and their combination, for the preparation of highly pure, metal free, thiophene based materials.

1.1. Oligothiophenes scenario

During the last two decades, thiophene based oligomers have found remarkable applications in organic electronics and biosensing.^{3-6,8} Oligothiophenes are advantageous with respect to polymeric materials in terms of well-defined structure, ease of purification and controllable properties.⁹ Their success depends on their intrinsic electronic properties, light emission and charge transport capabilities, but also on the easy processability, self-assembly and film forming capabilities. Most of these aspects can be fine-tuned by tailored chemical modifications of the thienyl rings that affect the overall structural coplanarity, the extension of π - π delocalization, thus the final solid state and solution properties.

The versatility of thiophene chemistry allows for a great diversity in thiophene-based chemical structures (Scheme 1). Thiophenes can be functionalized in the positions α and β to sulphur, or on the sulphur atom itself and regioregular oligomers and polymers with the most various functionalization can be prepared. Oligomers can be linear, branched or star-shaped and even all-thiophene dendrimers can be prepared.⁸

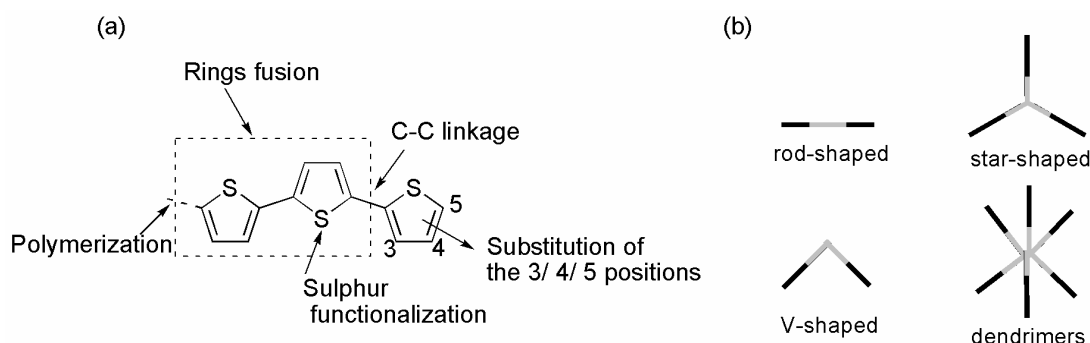

Scheme 1. (a) Type of functionalization allowed by oligothiophene skeleton and (b) different molecular shape imparted by shape inducing cores.

Molecular engineering is of main importance in materials science since it provides a tool to better elucidate the structure-properties relationships of the newly synthesized compounds, thus allowing for a

of thienyl metallated reagents with thienyl halogenides or triflates in the presence of palladium catalysts.

The Suzuki reaction has proven to be the most popular due to the mild reaction conditions and the handling and removal of boron-containing by-products which is easy when compared to the other organometallic reagents. The large number of thienyl boronic acids that are commercially available makes the Suzuki reaction and related types of coupling chemistry highly attractive in the context of high throughput synthesis of oligothiophenes and derivatization. In addition, boronic acids are air and moisture stable and of relatively low toxicity.

The catalytic cycle of the Suzuki-Miyaura reaction involves the oxidative addition of organic halide to the Pd complex to form the organopalladium halide, often the rate-determining step. The following transmetalation step provides the diorganopalladium complex which can undergo a reductive elimination, leading to carbon-carbon bond formation and regeneration of the catalyst. The role of the base allows the formation of the more nucleophilic boronic-ate-complex, accelerating the transmetalation step. Aryl bromides, iodides and triflates are often used as substrates. Na_2CO_3 , Cs_2CO_3 , KF, CsF and NaOH are the most used bases.¹⁵ Various phosphine ligands are effective in stabilizing the Pd^0 species and the most used catalyst is the commercial $\text{Pd}(\text{PPh}_3)_4$. Continuous improvements in reaction conditions are reported and recently examples of the Suzuki reaction in absence of metal catalysts and in water have been described.¹⁶

Unfortunately, the use of organometallic catalysts in this process presents a number of drawbacks including the presence of by-products either originated by the demetallation or dehalogenation of the starting materials or by homo-coupling or boron-halogen exchange side reactions, as well as the presence of catalyst residues. These contaminants are often strongly detrimental to the electronic properties of thiophene-based materials. The fact that Suzuki cross-couplings can be readily carried out using water as the solvent, reusable solid supported catalysts, in conjunction with microwave heating opens new perspectives for the synthesis of metal-free and highly pure materials.

In the last few years, microwave assistance has proven to be an efficient tool not only to shorten reaction times (typically reaction completeness is achieved in a few minutes rather than several hours),¹⁷ but also to reduce the contamination by side-products. Therefore, it is not surprising that efficient and rapid microwave assisted protocols have been developed for the preparation of different families of oligothiophenes (with enhanced charge transporting, light emitting and liquid crystalline properties). Different MW assisted Suzuki cross-coupling based strategies in homogeneous liquid and solid phase or heterogeneous solid-liquid phase have been reported and are described in the following sections.

2. Solvent-free microwave assisted Suzuki coupling

It has been demonstrated that soluble oligothiophenes can be efficiently prepared by solid phase synthesis by using alumina/potassium fluoride as reagents support.¹⁸ The interest in this procedure stems from the absence of solvents and the possibility to recover the reaction products by simple filtration, while the catalyst and the salts formed in the course of the reaction remain on the solid support. Soluble thiophene based compounds spanning from dimers to hexamers have been efficiently prepared by Suzuki coupling of thienyl iodides and bromides with thienyl boronic acids or esters by using alumina/potassium fluoride¹⁹ as solid support.¹⁷

The optimization of reaction conditions was carried out using as the model reaction the Suzuki coupling of 2,5-dibromothiophene, **1a**, with 2-thiophene boronic acid, **2a**, both of which are commercial

products. To have a nice dispersion of reagents and catalyst on the solid support, a few drops of methanol were added to the mixture of Al₂O₃/reagents/catalyst, which were subsequently evaporated under reduced pressure. The target of the reaction is 2,2':5',2''-terthiophene, **3**, whose formation is always accompanied by variable amounts of by-products **4** and **5**, as shown in Scheme 3. All catalysts employed were commercial and used as received. The relative amounts of **3**, **4** and **5** formed using different catalysts and bases and estimated by GC/MS analysis, are reported in Table 1.

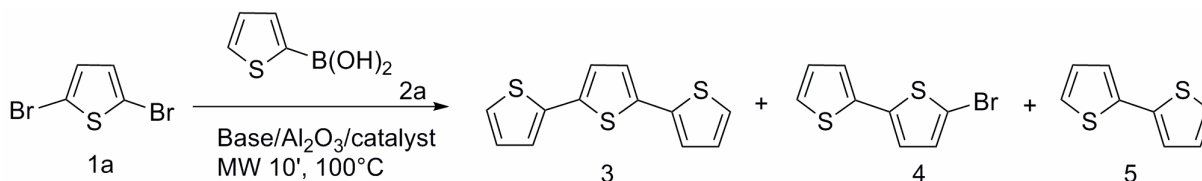

Scheme 3. Solvent-free, microwave assisted synthesis of 2,5':2',5''-terthiophene **3**.

Table 1 shows how crucial the choice of the catalyst is in determining the trend of the reaction. Indeed, there is no formation at all of terthiophene when Pd₂(dba)₃ or PdCl₂ are used as the catalysts, whereas this compound is formed in 60% isolated yield when commercial PdCl₂(dppf) is employed (entry 5). On the other hand, the attempt to prepare *in situ* PdCl₂(dppf) was unsuccessful, probably due to the scarce formation of the catalyst itself in the experimental conditions used. Also extremely important is the choice of the base, as shown, for example, by the fact that CsF, one the most used bases in the Suzuki reaction, is less effective than KF for the formation of trimer **3** (compare entries 7 and 5). Apparently, it is the type of base that is important rather than its strength, as indicated by the fact that when KO*t*-Bu is used only the starting materials are recovered (entry 8). Apparently, one never gets rid of by-products **4** and **5**, whose relative amounts is also dependent on reaction conditions. Since bithiophene **5** is easier to separate by silica gel chromatography than its monobrominated counterpart **4**, the conditions of entry 5 lead also to the mixture from which terthiophene **3** is more easily recovered.

Table 1. Catalyst and base optimization for the preparation of terthiophene **3** from 2,5-dibromothiophene **1a** and 2-thiophene boronic acid **2a** (Scheme 3).

Entry ^a	Catalyst	Base/Al ₂ O ₃	% ^b (1a / 3 / 4 / 5)
1	Pd(PPh ₃) ₄	KF	(54 / - / 6.5 / 3.5) ^c
2	Pd ₂ (dba) ₃	KF	(100 / - / - / -)
3	PdCl ₂	KF	(100 / - / - / -)
4	Pd(PPh ₃) ₂ Cl ₂	KF	(81 / 2 / 11 / 2.5)
5	PdCl ₂ (dppf)	KF	(4 / 73 / 1 / 22)
6	PdCl ₂ (dppf) <i>in situ</i>	KF	(61 / 17 / 12 / 10)
7	PdCl ₂ (dppf)	CsF	(16 / 50 / - / 34)
8	PdCl ₂ (dppf)	KO <i>t</i> -Bu	(100 / - / - / -)

^a1 eq. of **1a**, 2.5 eq. of **2a**, 5 mol % of catalyst, 5 eq. of KF and 150 mg of Al₂O₃, T=100 °C.

^bConversion estimated by GC/MS analysis. ^cBy-products from phosphine reaction.

Also the halide chosen for the reaction appears to be very important. Indeed, when the preparation of terthiophene was carried out using 2,5-diiodo-thiophene (**1b**), instead of the dibromo counterpart (**1a**), the yield dropped to 17% (see below, Table 2). In the subsequent work, we then used mainly mono and dibromo

starting materials, PdCl₂(dppf) as the catalyst and KF as the base, with the aim of fixing the conditions for a reasonable standardization of the synthetic procedures.

2.1. Unsubstituted quarter- and quinquethiophene

The different reaction patterns employed for the preparation of α -conjugated quinque- and sexithiophene are summarized in Scheme 4, whereas Table 2 shows the isolated yields for the different patterns and gives, for comparison, also the isolated yields of terthiophene prepared according to the modalities described above.

The results reported in Table 2 show that the careful optimization of the reaction conditions allows to obtain in few minutes high yields and mixtures that are easy to separate into the different components. Isolated yields of 60–80% can be obtained by choosing the appropriate boron and halogen derivatives. These yields are highly reproducible and competitive with the best yields already reported for quaterthiophene **7** and quinquethiophene **12**.²⁰

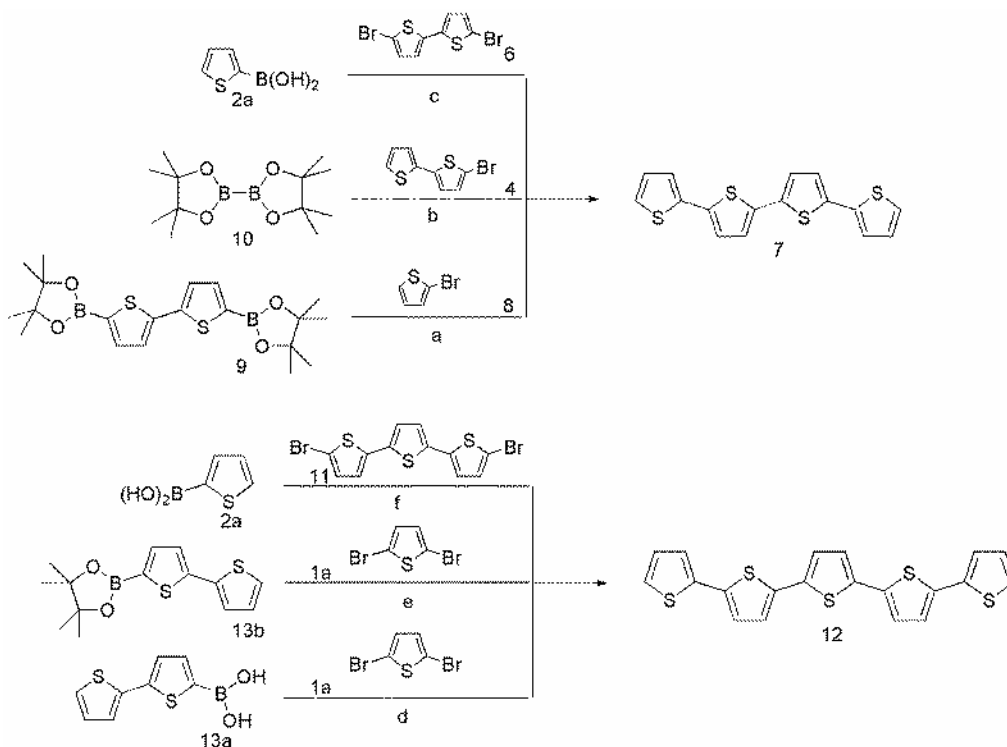

Scheme 4. Solvent-free, microwave assisted synthesis of quaterthiophene (**7**) and quinquethiophene (**12**).

The data show that in terms of reaction yields, facility of purification procedures and solvent saving, it is much better to grow the oligomer size by adding the thiophene rings one at a time rather than reacting longer building blocks. For example, as shown in Table 2, quinquethiophene **12** is obtained in high yield (74% isolated yield) when dibromoterthiophene is reacted with thiophene boronic acid (**2a**), whereas the yield is drastically reduced (28% isolated yield) when dibromodithiophene (**1a**) is reacted with bithiophene boronic ester (**13b**). In part, this is due to the fact that, in the former case, **12** is more easily purified from the major by-product of the reaction (bithiophene, generated by homocoupling of thiophene boronic acid). In the latter case, the major by-product of the reaction is quaterthiophene, which is less easily separated from the desired quinquethiophene. Table 2 also shows that no formation of **12** was observed when bithiophene

boronic acid **13a** was used instead of the corresponding ester. We ascribe this result to the greater stability of boronic esters compared to boronic acids.

The synthesis of quaterthiophene, pattern b, is of some interest. Indeed, the reaction of 5-bromo-2,2'-bithiophene, **4**, with bis(pinacolato)diboron, **10**, affords quaterthiophene in few minutes and in good isolated yield (65%). Bis(pinacolato)diboron is generally used for borylation of aryl halides²¹ and for the one pot synthesis of biaryls through the *in situ* formation of aryl boronates.

This reaction works well with thienyl, bithienyl and terthienyl monobromides, leading to the rapid formation of bi-, quarter- and sexithiophene in fair amounts. Due to sexithiophene poor solubility, the methodology described here and the reaction work up had to be modified as described in the Section 3.

Table 2. Reaction conditions^a and yields for the synthesis of terthiophene (**3**), quaterthiophene (**7**) and quinquethiophene (**12**), according to the patterns of Scheme 4.

Halide	Boronic derivative (eq.)	Product	Time (min.)	T _{max} (°C)	Isolated yield (%)
1a	2a (2.5)	3	10	100	60
1b	2a (2.5)	3	10	100	10
6^b	2a (5)	7	3	80	81
8	9 (0.5)	7	2	80	40
4	10 (0.5)	7	6	80	65
11^c	2a (4.4)	12	11	70	74
1a	13a (2.0)	12	10	90	No reaction
	13b (2.0)	12	10	90	28

^a5% mol % of catalyst, 5–10 eq. of KF. ^b0.2 ml of KOH added. ^c0.4 ml of KOH added.

Since it is known that aryl halides in the presence of palladium catalysts may give rise to reductive coupling,²² the question arose as to whether and to what extent the formation of even number oligothiophenes was the result of the palladium promoted homocoupling reaction rather than of the two step borylation-cross coupling reaction. Experiments carried out in the absence of bis(pinacolato)diboron in the same experimental conditions showed that the palladium promoted homocoupling of thienyl halides amounted to a few % at the best.

2.2. Self-affinity and electrical properties of T5

There are many open questions about semiconductor conjugated materials as electric charge carriers, but it is a consolidated opinion that high structural ordering is a necessary, although not sufficient, condition for achieving large charge carrier mobilities required for technologically attractive device applications. The coherence length of the crystalline domains formed by these compounds in thin films (typically 10–100 nm) is not the only relevant length scale, but also correlation lengths that characterize the thin film morphology become extremely important and need to be understood and controlled.

It is not trivial how to control on the same footings the molecular ordering, that depends on weak interactions, and the morphology, that is governed by the mechanism of growth. A challenging problem is to

find suitable materials and processing strategies able to yield ordered, organised architectures across the length scales, connecting the molecules to the device structure.

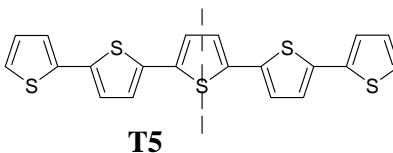

The most studied thiophene oligomer is α -sexithiophene (**T6**), which is a liquid crystalline compound and exhibits spontaneously long range molecular order.^{6d} **T6**, however, is insoluble and this makes achieving high purity standard for electronic applications difficult. α -Quinquethiophene **T5** (**12**, Scheme 4) is more difficult to synthesize than **T6**, but it has the advantage of being slightly soluble in a few organic solvents that makes it easier to purify. At the same time, solubility offers the possibility of processing thin films by solution deposition or casting, that are more relevant in view of large area applications.^{10a}

The odd number of thiophene rings of **T5** makes its molecular symmetry different from that of the even-term oligomers. This, together with the presence of a permanent dipole, may produce different supramolecular architectures with respect to even-term compounds.

It has been shown²³ that **T5** films (from sample prepared by the above mentioned microwave assisted Suzuki coupling protocol), obtained by a simple melting-quenching procedure, exhibit an enhanced crystal order together with a remarkable self-affine morphology, spanning length scales from tens of nm to hundreds of μm as observed by X-ray diffraction, atomic force and optical microscopies. Such **T5** films yield hole mobilities that compare to **T6** thin film FET mobility.

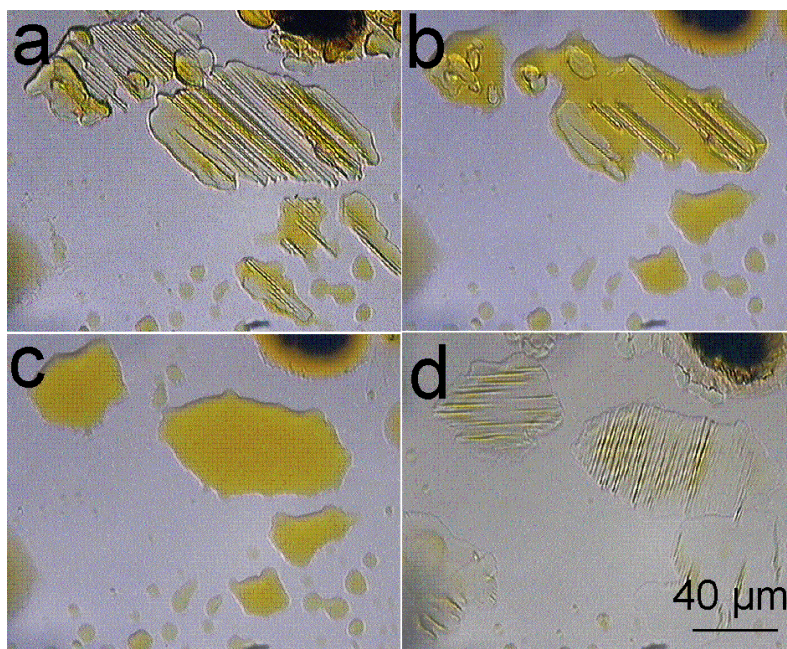

Figure 1. Optical micrographs (parallel polarizers) of melt-quenched **T5** powder: (a) after the first melting-quenching cycle; (b, c) melting; (d) after the second thermal quenching.

Melting of **T5** powder at $T \approx 250$ °C followed by rapid thermal quenching to ambient temperature, led to a morphology reorganization, with the appearance of uniaxially aligned microsized stripes in the

recrystallized sample. The formation of the stripes was reversible, as they always formed in repeated melting-quenching cycles. However, the orientation of the stripes changed with respect to the isotropic glass substrate from one cycle to the other, indicating random nucleation (Figure 1).

The same phenomenology was consistently observed in thin films of different thickness, either high vacuum evaporated or spin-coated, provided the temperature was allowed to drop rapidly after melting had occurred. Since **T5** tends to sublime at temperatures close to the melting point, the melting-quenching process was performed on thin films covered with a glass slip. The melting of the films led to the formation of microscopic droplets, hundreds of μm in diameter, that, after thermal quenching, exhibited stripes similar to those shown in Figure 2 and that were reversibly formed upon repeating melting-quenching cycles without any memory effect of previous orientations.

The melted-quenched thin films were investigated by AFM operated in non contact mode. As shown in Figures 1 and 2, the film morphology is characterized by striped domains even at length scales substantially smaller than the ones accessible to the optical microscope. It is clear from Figures 2a and 2b that a similar morphology is retained upon change of the spatial scale of observation of more than one order of magnitude. The quantitative matching of a morphology onto another at different length scales requires anisotropic scaling of the topography height. This type of scaling behaviour of the thin film morphology is termed self-affinity²⁴ and it has been previously observed in **T6**²⁵ and other oligomer thin films²⁶ grown in out of equilibrium conditions.

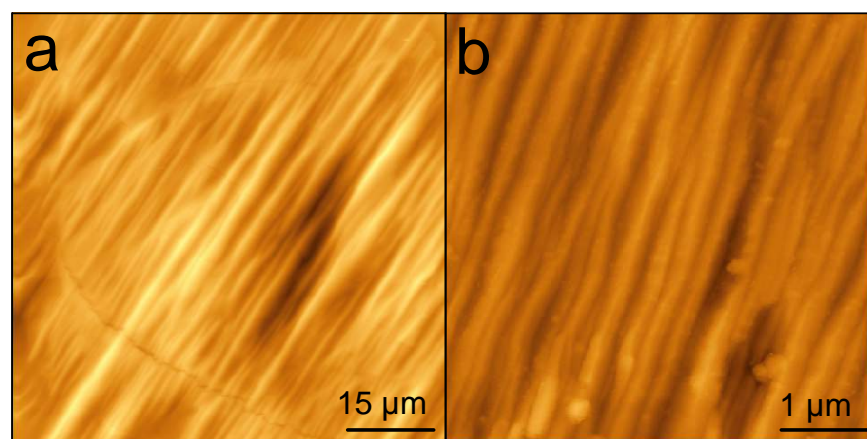

Figure 2. AFM images of **T5** on glass after melting-quenching cycle. The two images show the similarity in morphology at different magnifications: (a) height range z : 0–940 nm; (b) height range z : 0–370 nm.

In order to quantify the self-affinity, in Figure 3 the power spectral densities (PSD) estimated from AFM images at different scan lengths are compared.^{14b} PSD contains the information about the roughness, viz. the height fluctuations and how this is correlated in space. It appears that for each scan length fluctuations are spatially correlated (power-law decaying region vs spatial frequency) at high frequency. This extended power law decay is a fingerprint of self-affinity. On the other hand, uncorrelated “white” spectrum (plateau) at low frequencies spans a few points, suggesting that the breakdown of correlations can be mainly ascribed to the finite AFM image size. This is confirmed in the inset, showing that the estimated correlation length is linear with the scan length of the AFM image.¹⁹ Cropping together the spectra reveals that, apart for the few points of white spectra at each length scale, the power law decay spans across three orders of

magnitude of the spatial frequencies, viz. the whole range explored by the atomic force microscope. From the similarity with the optical measurements in Figure 1, we can infer that such a behaviour would propagate at length scales up to hundreds of μm .

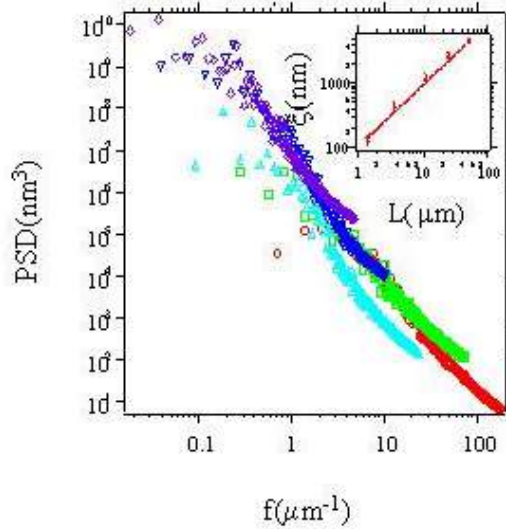

Figure 3. Power spectral density (PSD) of the topography from AFM images of different scan length: L (μm)=54 (lower triangles), 24(diamonds), 10 (upper triangles), 5 (squares), 1 (circles). Inset shows the estimated correlation length (viz. the inverse of the breakdown frequency separating power law decay from the apparent plateau) vs the scan length L . The continuous line is the power law fitting yielding $x \approx L^{0.95(0.03)}$.

Thin film field-effect device with the bottom-contact configuration was used to measure the charge carrier mobility of **T5** (Figure 4a). **T5** film was grown by vacuum sublimation on the gate insulator and the source and drain metal electrodes.

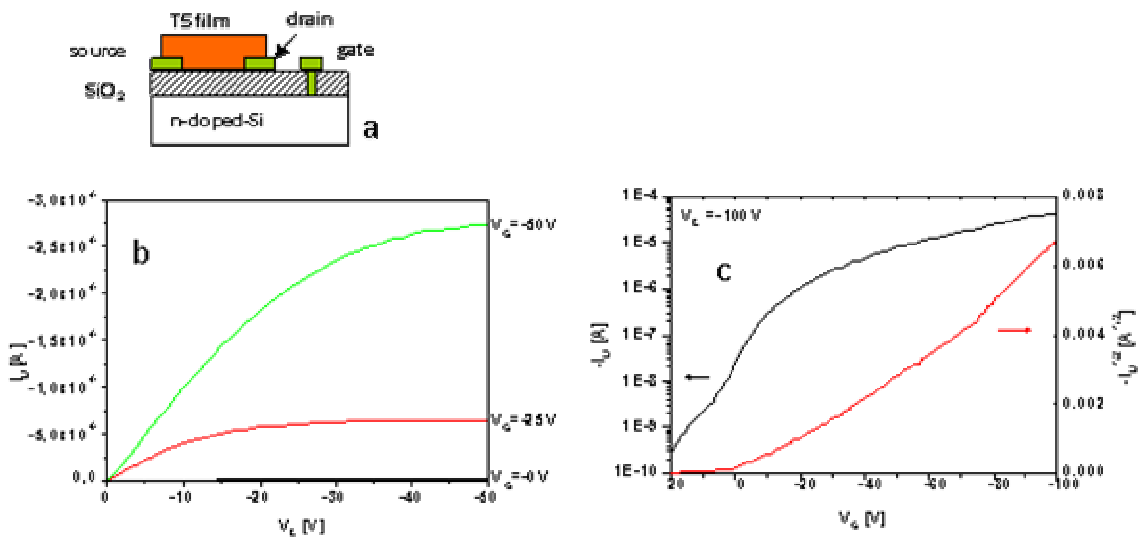

Figure 4. (a) Bottom-contact configuration of the TFT device. (b) Plot of the drain current I_D characteristic versus drain voltage V_D at different gate voltages (V_G). (c) Semilogarithmic plot of I_D versus V_G (left y axis) and plot of $I_D^{1/2}$ (right axis).

In order to improve the electrical performance of **T5** films, different film thicknesses and substrate temperature were tested. Best electrical behaviour was obtained for 20 nm film thickness, while the change of the substrate temperature between 30 °C and 60 °C did not introduce any significant improvement.

In Figure 4b, a typical plot of drain current I_D vs drain voltage V_D at various gate voltages V_G is reported for a 20 nm **T5** film evaporated on 350 nm thermally grown SiO_2 as gate insulator and 100 nm gold source and drain electrodes. The heavily doped n-type Si wafer acts as gate for the FET devices. As expected, the channel current increases as the voltage becomes more negative, indicating that the carriers are positive charges (holes). In Figure 4c, left axis, the transfer characteristic for the same device operating in the saturation region ($-V_D > V_G - V_T$, where V_T is the FET threshold voltage) is reported.

The charge carrier mobility of **T5** calculated in the FET saturation regime is obtained from the slope of the plot of $|I_D|^{1/2}$ versus V_G (Figure 4c, right axis) and is $0.02 \text{ cm}^2/\text{V}\cdot\text{s}$ at room temperature.

The current modulation, usually referred to as $I_{\text{ON}}/I_{\text{OFF}}$ ratio, is around 5×10^5 when V_G is scanned from -100 V to 20 V and V_D is held constant at -100 V , while it reduces to 10^3 when scanning the V_G voltage from -100 V to 0 V , maintaining V_D at -100 V . This reduction is due to the high carrier concentration in the channel region related to the very large drain polarization used.

This data shows that in **T5** films a unique combination of molecular order and self-affine morphology is achieved, resulting in a self-organized hierarchical architecture across three-four orders of magnitudes of the spatial length scales. Such a behaviour has not been observed to this extent in any other organic semiconductor. Self-affinity across multiple length scales can become extremely desirable for charge transport because it would enable matching the correlation length of the active layer with the channel length in any FET devices. In this way, transistors would operate with single domains or highly correlated transport layers, improving their charge mobility and other relevant properties such as stress and modulation. From the fabrication point of view, the self-affine organization of **T5** into a transistor layout could be exploited for obtaining performant devices without the need of high-resolution down scaling of the device layout, that would be desirable in view of a sustainable electronics production.

2.3. Methyl substituted sexithiophene

The importance of methyl substituted sexithiophene stems from the fact that it is a soluble thienyl hexamer, which in the solid state is nearly planar, self-assembles in parallel layers and displays good charge transport properties.²⁷

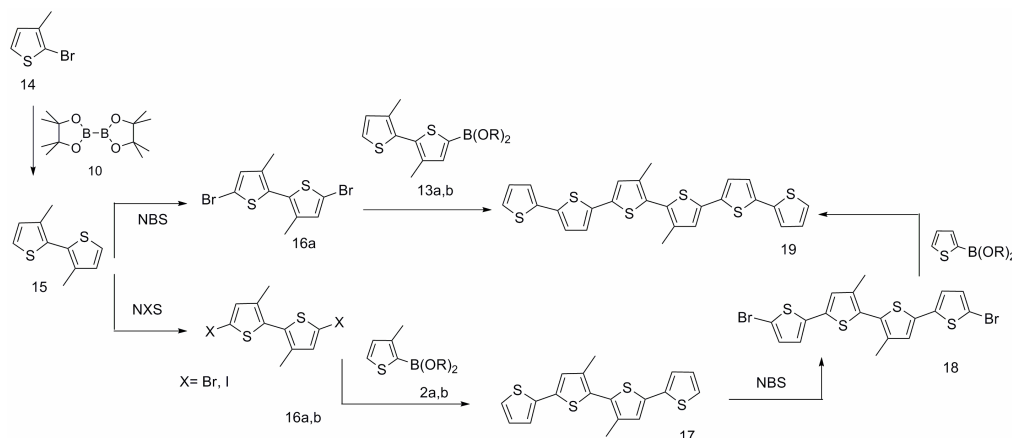

Scheme 5. Solvent-free, microwave assisted synthesis of sexithiophene **19**.

Stille coupling reaction, initially used for the preparation of this compound, afforded low yields.²⁸ However, microwave assisted Suzuki coupling methodology allows hexamer **19** to be obtained in much higher yields than before, since all steps afford high yields when one ring is added at a time and the diiodo derivative **16b** is employed instead of the corresponding dibromo derivative **16a** (see Scheme 5 and Table 3).

As shown in the Table, the reaction of 5,5'-diiodo-3,3'-dimethyl-2,2'-bithiophene, **16b**, with thiophene boronic derivatives affords quaterthiophene **17** in much higher yield than the corresponding dibromo derivative **16a**, contrary to what was observed in the preparation of **T3**, where the dibromo derivative worked much better than the diiodo one (Figure 5).

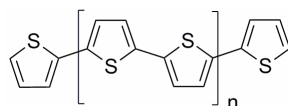

Figure 5

The reaction of 5,5'-dibromo-3,3'-dimethyl-2,2'-bithiophene, **16a**, with thienyl boronic acid or ester leads to the formation of quaterthiophene **17** in low yield. In this case, the main reaction products are a variety of oligomers containing repeated dimethyl bithiophene subunits and terminating with an unsubstituted thienyl ring, as already observed when thienyl stannane was used (Stille coupling). Tetramethyl sexithiophene (n=2) and hexamethyl octathiophene (n=3) were separated in sizeable amount. This reaction is highly reproducible and can be viewed as an expedient way to prepare in one pot regioregular head-to-head methyl substituted sexi and octathiophenes, which are easily separated by chromatography.

Table 3. Reaction conditions^a and yields for the synthesis of sexithiophene **19** (Scheme 5).

Halide	Boronic derivative (eq.)	Product	Time (min.)	Tmax (°C)	Isolated yield (%)
14	10 (0.5)	15	6	80	70
16a	2a (R=H, 3.5)	17	32	80	34
	2b (R=pinacol, 2.2)	17	3	80	18
16b	2a (4.4)	17	7	70	85
	2b (2.2)	17	3	70	90
18^b	2a (4.4)	19	30	80	73
16a	13a (R=H, 2.5)	19	10	90	No reaction
16a	13b (R=pinacol, 2.5)	19	3	90	36

^a5% mol % of catalyst, 10 eq. of KF. ^b0.5 ml of KOH added.

3. Liquid phase microwave assisted Suzuki coupling (less soluble oligomers)

The solvent-free procedure, described in Section 2, is very effective in the preparation of soluble oligothiophenes, but it cannot be applied in the case of insoluble thiophene oligomers, such as unsubstituted

sexithiophene, since the targeted products cannot be separated from the aluminium oxide used as the solid support in the solvent-free reaction. A slight modification of this protocol has been described for preparing less soluble materials.²⁹

In order to standardize the solution-phase, microwave assisted, Suzuki reaction conditions, the effectiveness of the PdCl₂dppf/KF catalytic system was tested in the synthesis of unsubstituted α -quinquethiophene (**T5**, **12**) from di-iodo-terthiophene **21** and thienyl boronic acid **2a**, using a 1:1 v/v toluene/methanol mixture as the solvent (Scheme 6).

The procedure depicted in Scheme 6 afforded **12** very rapidly (10 minutes) and in higher yield (isolated yield 85%) than the solvent-free procedure (isolated yield 74%) previously described,⁵ owing to the easier work-up of the crude product. Indeed, methanol evaporation during microwave irradiation led to the formation of a fine suspension of **T5** in toluene, which could easily be isolated by centrifugation/filtration and purified by washing with warm water and then recrystallizing from a dioxane/water mixture.

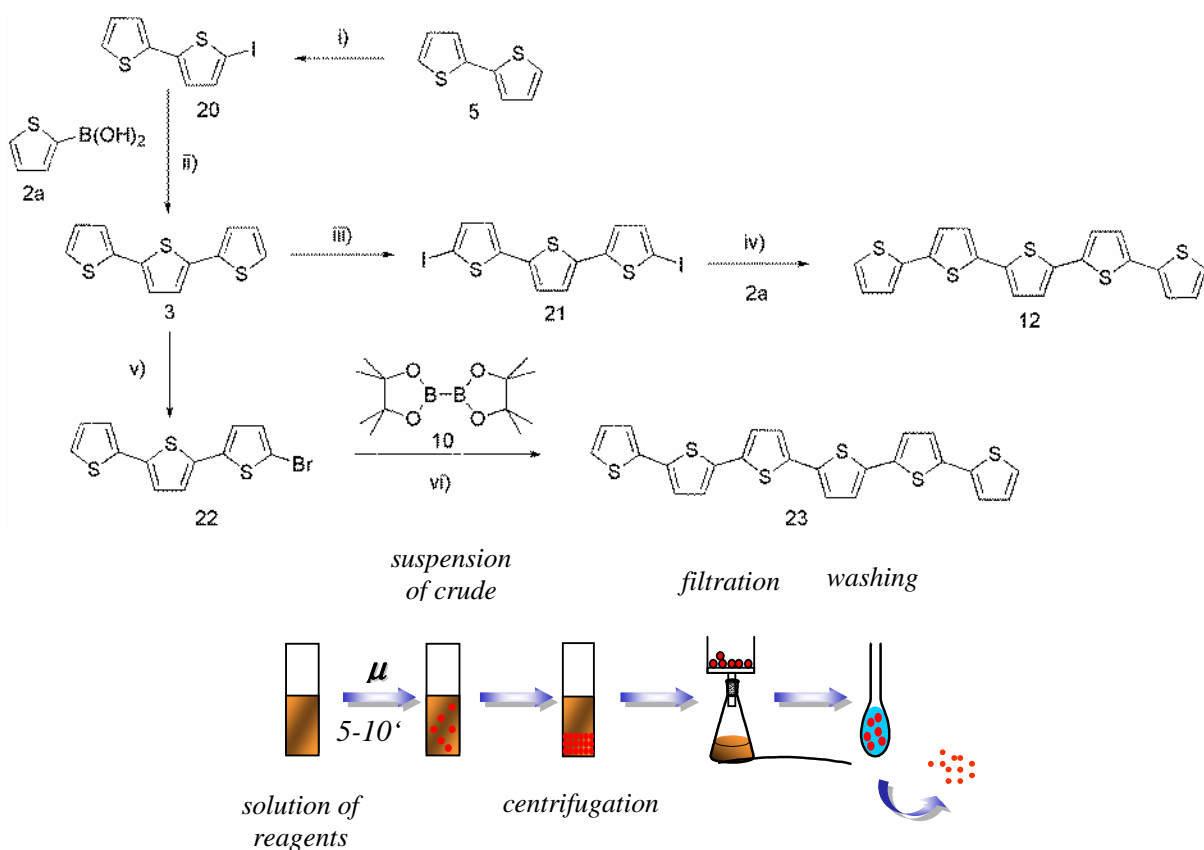

Scheme 6. Top: synthesis of quinquethiophene (**T5**, **12**) and sexithiophene (**T6**, **23**) from commercial bithiophene (**1**). i) NIS, DMF, overnight, $-20\text{ }^{\circ}\text{C}$; ii) PdCl₂dppf, basic alumina/KF, μv 5 minutes, max temp. $80\text{ }^{\circ}\text{C}$, 60% of yield; iii) NIS, CH₂Cl₂/AcOH overnight, rt; iv) PdCl₂dppf, toluene/methanol, μv 10 minutes, max temp. $70\text{ }^{\circ}\text{C}$; v) NBS, DMF; vi) PdCl₂dppf, toluene/methanol, μv 10 minutes, max temp. $70\text{ }^{\circ}\text{C}$.

Bottom: a sketch illustrating the preparation and purification procedures.

A very good yield was also obtained in the preparation of unsubstituted sexithiophene **23** (**T6**, Scheme 6) by the one-pot borylation/Suzuki reaction of 5-bromo terthiophene **22** with commercial bis(pinacolato)-diboron **10**. **T6** was obtained in 10 minutes and the crude product was easily purified using a procedure

similar to that described for **T5**, by first centrifugating the suspension formed in toluene, then washing the solid residue with warm water and then with CH₂Cl₂. Afterwards, centrifugation and washing with warm dioxane afforded **23** in 84% isolated yield.

3.1. Rigid core thiophene co-oligomers with liquid crystalline properties

The liquid phase procedure described above has been successfully extended also to the preparation of co-oligomers consisting of thienyl and several fused heterocycles, such as dithienothiophene (**DTT**), benzothiadiazole (**BTZ**) and 9-methyl-9*H*-carbazole (**CBZ**).

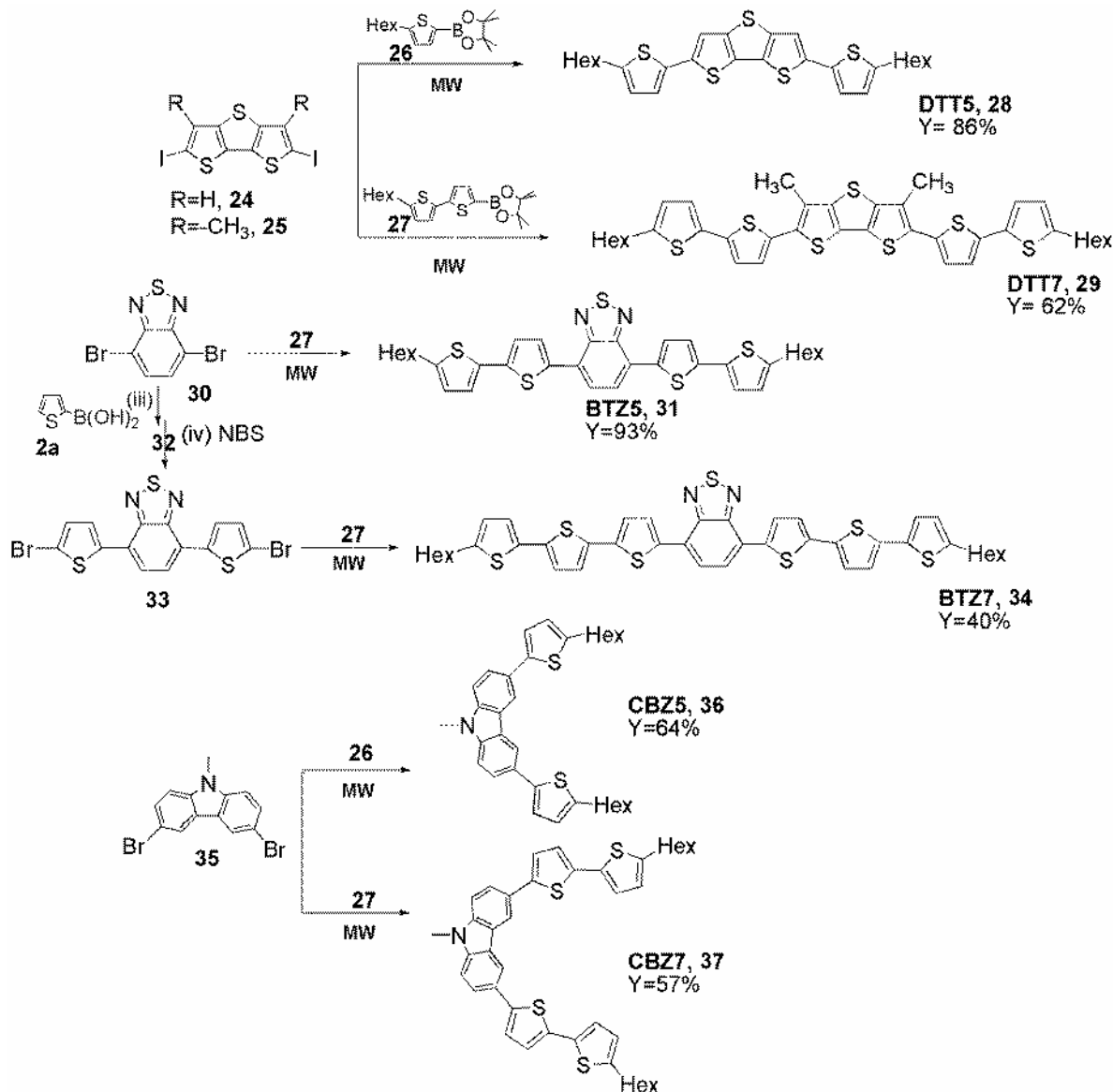

Scheme 7. Microwave assisted synthesis of rigid cores oligothiophenes.

Hex=*n*-hexyl, Y=yield in isolated product.

In particular, a new class of thiophene molecular compounds having rigid inner cores and flexible ends, characterized by liquid crystalline properties have been prepared by the above described optimized procedure.³⁰ By changing the nature of the rigid core unit, rod-like or bent-like oligomers were obtained. It

has been shown the dependence of the thermal, self-organization and semiconducting properties, on the molecular structure. Rigid cores, in particular carbazole ones, are known for the ability to enhance the thermal stability of organic molecules. Moreover the strong π - π stacking in the crystal packing originated by these systems is expected to promote highly ordered smectic phases and consequently enhanced charge transport capability.

Scheme 7 shows the molecular structure of all compounds prepared and the synthetic approach employed, consisting in binding the central rigid core units to thienyl or bithienyl lateral groups. Initially, all compounds were prepared by Suzuki-Miyaura cross-coupling between dibromo or diiodo rigid cores - obtained with NBS or NIS according to conventional procedures - and mono- or bithienyl pinacolatoborolane, using PdCl_2dppf as palladium source, KF as base and DMF or DMSO (100 °C) as solvents (Scheme 7). In this way, **BTZ5** was obtained in 52% yield after 6 hours in refluxing DMF and **CBZ5** and **CBZ7** in 32% and 16% yields, respectively, after 8 hours and repeated addition of Pd catalyst.

The yields were markedly improved (up to 90%, Scheme 7) and the reaction times lowered from several hours to few minutes, by using the liquid-phase microwave assisted Suzuki coupling described above. All the syntheses were scaled up to 0.5 g scale with isolated yields comparable and in some cases even better than those obtained on a 50 mg scale.

POM analysis on **DTT5 (28)** shows heterogeneous nucleation occurring at 120 °C. Further heating to 135 °C leads to the appearance of fibril-structures which grew anisotropically along one direction under isothermal conditions. The fibrils were highly birefringent; however the phase was rather fluid excluding a crystalline phase. Further heating of the sample above 145 °C led to a bright, colourful and fluid Schlieren texture and finally isotropization occurred at about 165 °C (Figure 6).

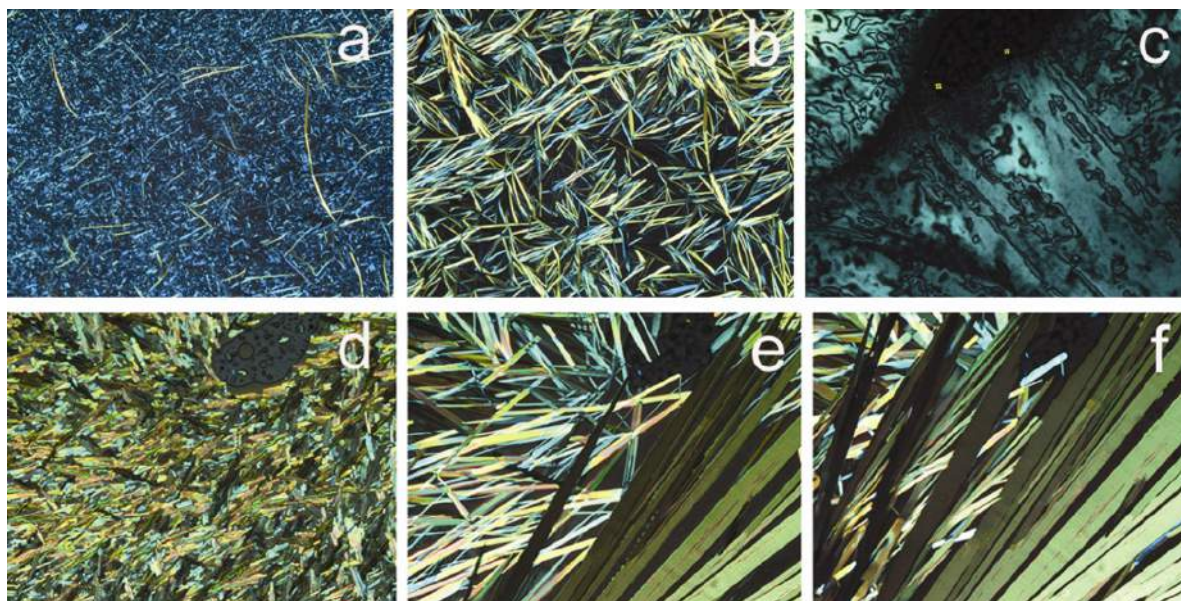

Figure 6. POM micrographs of **DTT5 (29)** showing the optical textures (crossed polars) of its phases (same region, from RT \rightarrow 145 °C): (a) fibril structures formed at 120 °C during the second heating; (b) fibrils growth by keeping the temperature between 130 °C and 140 °C; (c) Schlieren texture at 150 °C; (d, e, f) laminar domains growing from the melt by repeated melt-quench cycles 140 °C \rightarrow 135 °C \rightarrow 140 °C (first, second and third cycle, respectively). Image size 800 μm \times 800 μm .

On cooling the isotropic liquid of **DTT5** across the phase transition, droplets of Schlieren appeared at 154 °C which coalesced in a Schlieren domain observable for a very short range of temperatures.

A slight cooling of this texture resulted into the formation of lancet-like domains from the Schlieren that coalesce into larger laminar domains under isothermal conditions at 135 °C. Interestingly, the size of the laminar domains could be increased up to the millimeter scale by repeating the heating-cooling procedure between 135 and 140 °C (Figure 6d, e, f).

These large laminar domains showed uniform birefringence under polarized light indicating homogeneous alignment. They persisted to room temperature making this compound promising for FET application.³¹ The phase evolution of **DTT5** was also monitored by XRD. Figure 6 shows the variation of the XRD profile on increasing the temperature from RT to 145 °C and then cooling down to RT (scan rate 5 °C/min.). The profiles were recorded at different times to check if the phase stability was maintained on cooling to room temperature from 135 °C, as indeed was the case. The frozen phase displayed a strong Bragg reflection at $2\theta=6.3^\circ$ (d -spacing of 14 Å). By considering that the length of the **DTT5** molecule in a full extended conformation (adopted also in the crystal form) is about 30 Å, we suggest that the molecules are assembled as shown in the sketch of Figure 6, *i.e.* arranged in parallel rows shifted of a half molecule. Presumably, the driving force for this type of organization are the face-to-face π - π interactions between thiophene rings belonging to adjacent rows. The second most intense peak in the XRD pattern at $2\theta=22.4^\circ$ (d -spacing 4 Å) is likely to be related to suitable periodicity for orbital overlap between facing thiophene rings. No reflections were observed at 145 °C in accordance with the loss of order shown also by the high transition enthalpy values.

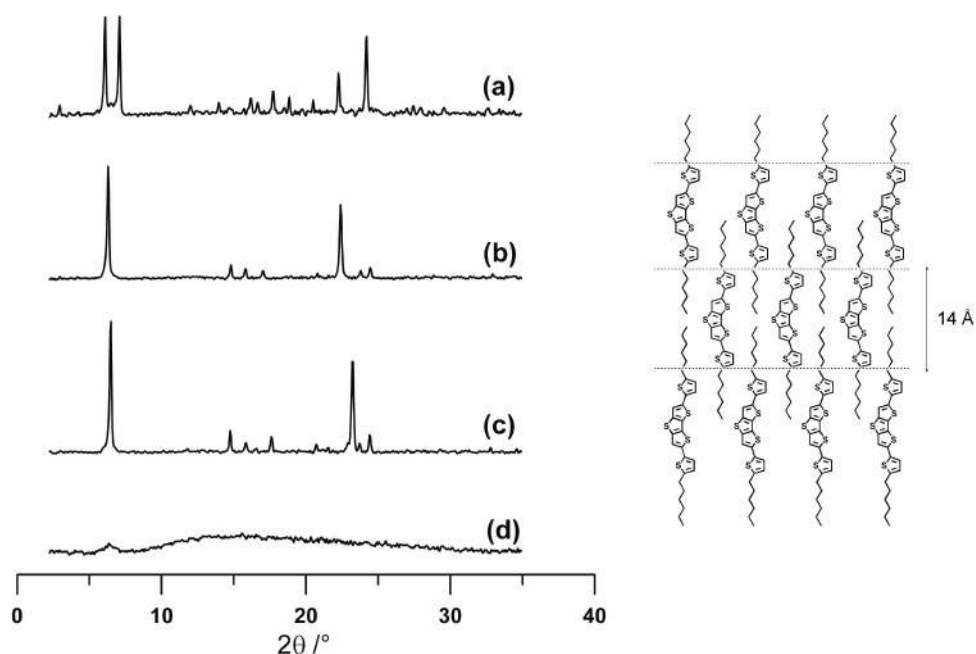

Figure 7. X-Ray diffraction profiles of **DTT5** (**29**): (a) at RT, (b), at 130 °C on heating, (c) at 70 °C upon cooling, (d) at 145 °C on heating. The sketch shows the proposed organization of **DTT5** molecules in the smectic mesophase (profile b).

Figure 7 shows the log-log current density-voltage (J-V) plots of an as-cast **DTT5** film compared to that obtained after annealing the sample at 137 °C for 5 minutes and then cooling down to room temperature.

Various annealing times were investigated and an enhancement of the current values was observed by increasing the time from 1 to 5 minutes. No further significant current variations were obtained for longer times, suggesting that the growing of the lamellar crystalline domains, observed by POM microscopy (Figure 6f), reaches a stable configuration in about 5 minutes annealing.

Figure 7 shows that there is a current increase of about two orders of magnitude upon annealing the sample. Furthermore, in the investigated voltage range, the current density shows an excellent quadratically dependence on the voltage. This behavior is typical of trap-free space-charge limited current (SCLC).³²

A hole mobility of $3.7 \times 10^{-3} \text{ cm}^2 \text{ V}^{-1} \text{ s}^{-1}$ was estimated for **DTT5** upon annealing.³³ The estimated charge mobility for the as-cast film - about two orders of magnitude lower than that of the annealed film - is consistent with the measured field-effect mobility measured for **DTT5**.

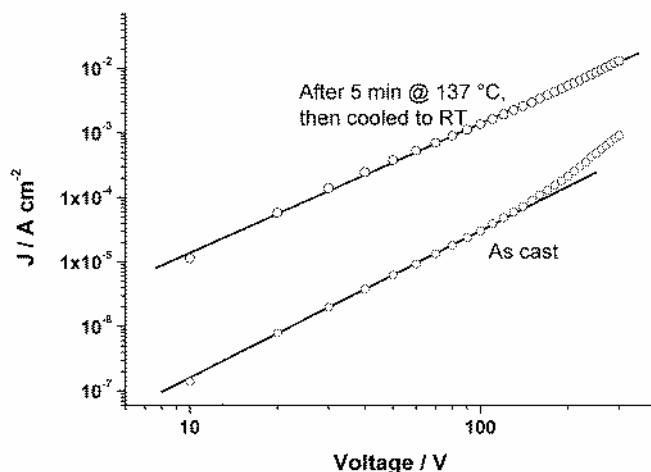

Figure 8. Room temperature J-V curves of a **DTT5** film onto interdigitated gold electrodes: as-cast and after annealing at 137 °C for 5 minutes and then cooling to RT. The measurements were carried out under dynamic vacuum of 10^{-5} mbar. The lines represent the linear fits to the experimental data.

4. Microwave assisted synthesis of oligothiophene semiconductors in aqueous media using silica and chitosan supported Pd catalysts

The use of organometallic catalysts in the synthesis of π -conjugated materials generally presents a number of drawbacks including the presence of by-products either originated by the demetallation or dehalogenation of the starting materials or by homo-coupling or boron-halogen exchange side reactions, as well as the presence of catalyst residues. Such impurities may alter the film deposition processes and therefore the morphology, conductivity and performance of the device prepared. As a consequence, preliminary expensive purification techniques including vacuum sublimation are often required for their successful applications.

The combination of microwave assistance with heterogeneous Pd catalysis has demonstrated to be a powerful tool to synthesize highly pure, metal free, thiophene based materials in very short time. Suzuki-Miyaura heterogeneous protocols³⁴ have been reported for the synthesis of biphenyl systems employing palladium supported on various materials including carbon,^{35,36} metal oxides, ceramics (perovskites), porous aluminosilicates, as well as on polymers³⁷ and biopolymers,^{38,39} the latter ones offering the advantages of being renewable, biodegradable and having low toxicity.

Chitosan and silica based Pd complexes have been demonstrated to be very effective under a wide range of conditions in the Suzuki and Heck couplings, being reusable up to 10 times.⁴⁰⁻⁴² Such catalysts, comprising bidentate organic ligands, grafted onto the solid support, that complex the active palladium salts, exhibited excellent stability (chemical and thermal), high surface areas, good accessibility and chemical versatility. Moreover, chitosan is a water-tolerant support that will potentially allow reactions to be carried out in aqueous media and has major advantages in that it can be formed into fibres, films, attached to reactor walls, etc. making it ideal for incorporation in different reactor designs (continuous/intensive, etc.). On the other hand, silicas can be easily prepared and allow for the robust attachment of organic functionalities and control over their surface chemistries.

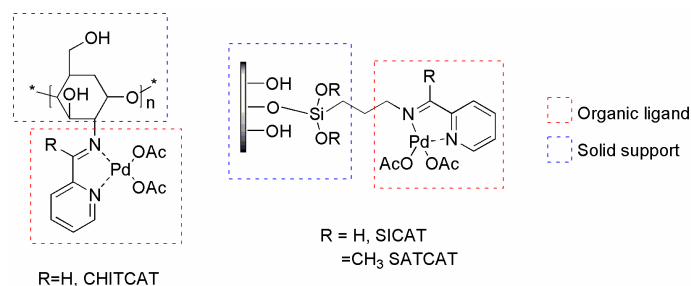

Scheme 8. Structures of the catalysts used in the present investigation. CHITCAT=chitosan supported Pd complex; SICAT=silica supported Pd complex 1 (R=H); SATCAT=silica supported Pd complex 2 (R=Me).

Selective and stable chitosan and silica supported palladium complexes (Scheme 8) in aqueous ethanol have been recently employed for the preparation of thiophene-based materials, using a microwave assisted Suzuki coupling methodology.⁴³

Substituted co-oligomers containing fused heterocycles into the aromatic backbone can also be prepared in high yields and good level of purity in a short period of time, without the need for further purification.

This protocol has shown to be irrespective of the size and substitution of the thienyl derivative, compared to homogeneous Suzuki methodologies which usually require an optimization of the reaction conditions for each substrate.

4.1. Optimization of the reaction conditions

The reaction optimization was performed on two commercially available substrates, namely 5-bromo-2-thiophenecarboxaldehyde **38** and 2-thienylboronic acid derivative **2a** (Scheme 9). Supported palladium catalysts were tested under both conventional heating and microwave assisted conditions. Data are summarized in Table 4. Previous reported studies on the Suzuki cross-coupling of thienyl derivatives proved KF was a very suitable base for these systems.²³

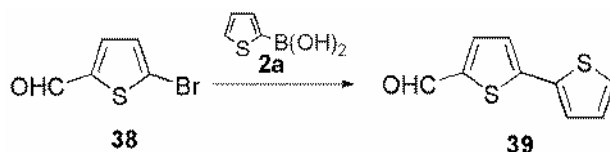

Scheme 9. Model reaction between 5-bromo-2-thiophenecarboxaldehyde and 2-thienylboronic acid.

The use of CHITCAT as catalyst and KF as the base in aqueous ethanol (1:1) afforded a complete conversion of the starting materials to the coupling product **39** in only 2 minutes of microwave irradiation at 130 °C (Table 4, entry 2). The same reaction carried out under conventional heating provided a poor 55% conversion after 48 hours.

The use of an aqueous environment was also found to be particularly advantageous for an optimum catalytic performance with respect to the use of toluene or other organic compounds as solvents. This can be ascribed to the different solubility of KF in toluene and alcoholic solvents as well as to the more efficient absorption of MW from polar solvents. Medium to high microwave absorbing solvents, including EtOH, isopropanol and water, may allow a more efficient internal heating compared to microwave transparent solvents (toluene) usually employed in heterogeneous Suzuki reactions.³⁹⁻⁴²

Table 4. Catalytic performance of different supported Pd complexes in the model reaction (Scheme 9).

Entry	Base	Catalyst	Solvent	MW conditions	39 Conversion (%) ^b
1	KF	SICAT	EtOH/H ₂ O (1:1)	100 W, 60 min., 80 °C	87
2 ^a	KF	CHITCAT	EtOH/H ₂ O (1:1)	100 W, 2 min., 130 °C ^d	>99
3 ^a	KF	CHITCAT	toluene	100 W, 60 min., 130 °C	8
4 ^a	KF	SATCAT	EtOH/H ₂ O (1:1)	100 W, 60 min., 80 °C	82
5 ^c	KF	SATCAT	isopropanol	100 W, 60 min., 80 °C ^d	96
6	KF	SATCAT	toluene	220 W, 60 min., 80 °C	20

^acarried out with simultaneous cooling; ^bGC conversion; ^chigher power values did not remarkable improve the reaction conversion; ^dthe pressure measured was about 80 and 20 psi for entries 2 and 5, respectively.

Silica supported palladium catalysts (SICAT and SATCAT) required lower reaction temperatures (80 °C vs 130 °C) but much longer reaction times (60 minutes) compared to chitosan in order to achieve comparable conversion values.

Clearly, the choice of the catalyst has to take into account several factors including the thermal stability of the boronic-substrates and the size of the target oligomer. Chitosan will possibly be more suitable for stable and smaller substrates compared to silica, in which the porous structure will surely be an attractive feature in reactions with larger molecules.

A hot filtration test (HF) was performed to prove the truly heterogeneous nature of the catalytic reaction (entries 2 and 4, Table 4).⁴⁴ The hot reaction mixture (typically less than half way through completion) was filtered off and the supernatant and the solid were recovered separately. Fresh substrates were added both to the liquid filtrate and to the solid and another reaction (under the same conditions) was conducted. The results of the second reuse of CHITCAT are included in Figure 9. The catalyst was filtered off after 60 seconds of microwave irradiation (~30% conversion). The reaction mixture without catalyst was then MW irradiated for 30 additional minutes and finally quenched. No changes in conversion were observed, excluding the presence of a substantial concentration of palladium leached species in solution. The Pd content in solution determined by ICP was 1.8 ppm, confirming that the Pd leaching in the systems was almost negligible.

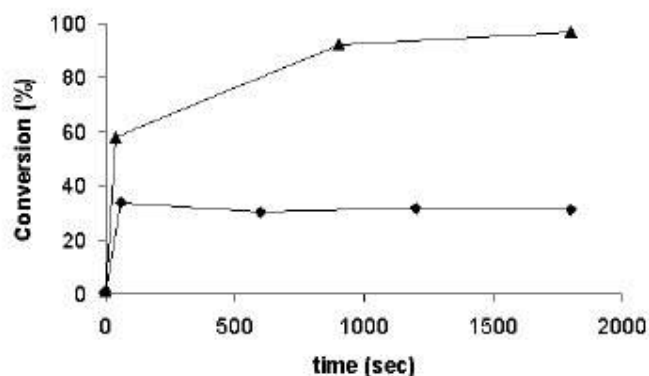

Figure 9. Hot filtration test. Effect of removing the chitosan supported palladium catalyst from the second cycle reaction of 2-thienylboronic acid and the 5-bromo-2-thiophenecarboxaldehyde.

The catalyst reusability was also investigated under the optimized conditions. The catalyst was filtered off after each reaction run, washed with aqueous methanol and pure methanol, dried at 90 °C and subsequently reused in another catalytic cycle. Despite an increase in the time of reaction required for complete conversion, the catalysts were reusable up to 4 times preserving more than 95% of the initial catalytic activity (entry 2, Table 5). The observed slight reduction in catalytic activity with recycling probably can be due to a partial blockage or deactivation of the active sites of the catalyst with the salts and/or by-products from the reaction.

Table 5. CHITCAT reusability experiments carried out under microwave irradiation with simultaneous cooling.

Cycle	Base	Catalyst	Alcohol/water	MW conditions	39 (%)
1 st	KF	CHITCAT	EtOH/H ₂ O (1:1)	100 W, Temp. 130 °C, 1 min.	>99
2 nd	KF	CHITCAT	EtOH/H ₂ O (1:1)	100 W, Temp. 130 °C, 30 min.	97
3 rd	KF	CHITCAT	EtOH/H ₂ O (1:1)	100 W, Temp. 130 °C, 45 min.	98
4 th	KF	CHITCAT	EtOH/H ₂ O (1:1)	100 W, Temp. 130 °C, 45 min.	95

4.2. Extension to other substrates

The above-described optimised conditions based on the use of the CHITCAT and SATCAT materials were then extended to various thienyl-based substrates.

Iodo-derivatives were found to be more effective than bromo-derivatives in the preparation of bithiophene (Scheme 10, Table 6), irrespective of the conditions employed (solvent and/or catalyst). Therefore, only thienyl iodides were employed for the synthesis of longer oligomers.

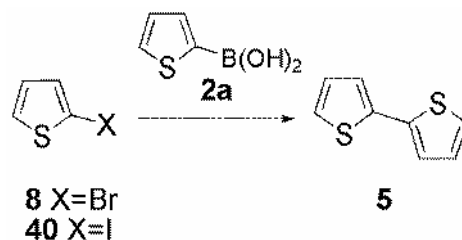

Scheme 10. Suzuki reaction for the preparation of bithiophene (**5**) from a range of halo-thiophenes.

The methodology was then further extended to the preparation of larger (α - β alkyl) substituted oligomers. Terthiophene (**3**) is a useful building block for the preparation of thiophene-based oligomers and polymers. Many synthetic routes to α -terthienyl have been reported. A previously reported solvent-free microwave assisted Suzuki coupling (see Section 2) provided a maximum isolated yield of 60% starting from 2,5-dibromothiophene, much lower than that reported in Table 7 starting from the di-iodo derivative.

Table 6. Catalytic performance of various Pd catalysts in the preparation of bithiophene from 2-thienyl bromide and 2-thienyl iodide .

Entry	Reagent	Solvent	Catalyst	MW conditions	Yield 5 (%) ^a
1 ^b	8	EtOH/H ₂ O (1:1)	CHITCAT	100 W, 130 °C, 60 min.	8
2 ^b	40	EtOH/H ₂ O (1:1)	CHITCAT	100 W, 130 °C, 60 min.	57
3	8	isopropanol	SATCAT	100 W, 80 °C, 60 min.	36
4	40	isopropanol	SATCAT	100 W, 80 °C, 60 min.	61

^aisolated yield. ^bCarried out with simultaneous cooling.

Quaterthiophene (**T4**, **7**) is one of the most investigated thiophene derivatives for its photoluminescence⁴⁵ and charge transport properties.⁴⁶ Terminal alkyl substituted **T4** compounds are also of interest as they exhibit liquid crystalline behaviour and enhanced solubility that make them particularly suitable for solution processing.⁴⁷ **T4** derivatives are usually prepared by using the bi-directional 1+2+1 approach consisting in the reaction between two equivalents of boronic or halo-thienyl derivative and one equivalent of the corresponding reaction partner.²⁷ For the preparation of quaterthiophenes **7** and **17**, we chose the reaction between boronic thienyl derivative **2a** and the bifunctional iodo-dimers **8** and **42** that afforded good yields for both unsubstituted and β -methyl substituted **T4** compounds (entries 2 and 3 Table 7).

Unsubstituted or functionalized α -quinque- and hexathiophenes were also prepared. Such systems show high self-assembly capability and good charge transport properties in Field Effect Transistors (FET). Two different strategies were employed and compared for both compounds. Quinquethiophene (**T5**, **12**) was prepared either by adding two boro-functionalized monomers to the diiodoterthiophene (**21**) (+1 strategy,

Figure 10), or by reacting the diiodothiophene (**41**) with two equivalents of borobithiophene (+2 strategy, Figure 10).

Table 7. Preparation of various oligothiophenes derivatives using supported Pd complexes.

Entry	Starting material	Product	Catalyst	MW conditions	Yield ^b (%)
1 ^a			CHITCAT	100 W, 30 min., 130 °C	87
2 ^a			CHITCAT	100 W, 100 min., 130 °C	83
3			SATCAT	100 W, 100 min., 80 °C	77
4			CHITCAT	100 W, 100 min., 130 °C	37
5			SATCAT	100 W, 100 min., 80 °C	82
6			SATCAT	100 W, 100 min., 80 °C	65
7 ^c			SATCAT	100 W, 100 min., 80 °C	traces
8			CHITCAT	100 W, 100 min., 130 °C	69

^aIn entry 1, the reaction was carried out with simultaneous cooling. For entry 2, both methodologies were used, with and without simultaneous cooling, obtaining similar results (66% after 60 min. employing simultaneous cooling). ^bIsolated yield. ^cThe dibromo derivative was more soluble than diiododerivative under the reaction conditions.

Similarly, hexathiophene **19** was prepared by means of a +2 approach (using the di-iodobithiophene **16b**) as well as by the +1 strategy employing di-bromoquaterthiophene **18** as starting material.

The choice of the synthetic pathway is usually dependent on many factors including the availability of the starting materials and the formation of by-products such as deborylated thiophenes, homo-coupling and metal-halogen exchange products that have to be removed from the target compounds.

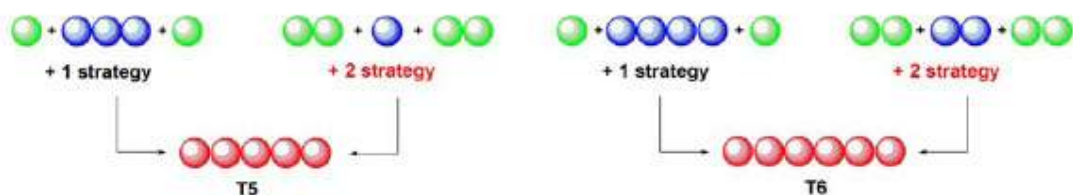

Figure 10. Overview of the strategies investigated for the synthesis of **T5** and **T6** materials.

The +1 strategy led to by-products easily separated from the reaction mixture, facilitating the purification of the desired product. However, the starting materials are complex systems, therefore additional synthetic steps are required in order to obtain them. Despite the previously discussed results on homogeneous microwave assisted Suzuki coupling pointing out that the +2 strategy was unfavorable (due to the formation of **T4** by-products difficult to remove), it proved to be the most effective for the synthesis of both **T5** and **T6** oligomers (Table 7, entries 5 and 6), as it involves readily available precursors and easily purified products, thus improving the green credentials of the reaction.

In the reaction conditions the larger building blocks, including ter- and quaterthiophene, are poorly soluble and consequently less reactive. Moreover, their higher steric hindrance is believed to restrict the oxidative addition to palladium, which is less pronounced than in homogeneous conditions.

Steric effects can also explain why SATCAT and CHITCAT catalyzed reactions show undetectable boron-halogen exchange by-products. The oxidative insertion of Pd in the C–B bond takes place when the C–I bond insertion reaction is very slow. The presence of supported Pd (II) reduces the probability of such insertion therefore minimizing the presence of undesired boron-halogen exchange by-products.

Preliminary investigations on quinque- and hexathiophenes prepared in this way (**12**, **19**, **42**) pointed out that these compounds may display enhanced film forming properties than the same compounds prepared by conventional homogeneous catalysis, due to their higher level of purity. Melted homogeneously prepared **T5** powder sandwiched between two glasses rendered a viscous fluid containing black solid aggregates which melt at temperatures over 350 °C. Such aggregates can be removed upon purification by vacuum sublimation, suggesting they may be residues of the catalyst and/or impurities. No evidence of similar impurities were observed in the preparation of **T5** using the heterogeneous protocol (Figure 11).

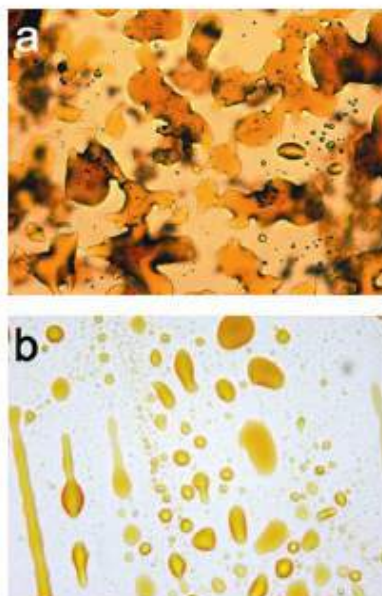



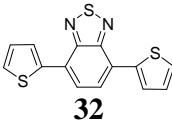
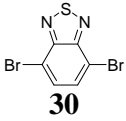
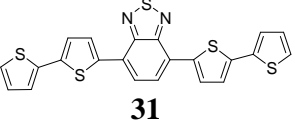

Figure 11. Optical microscopy image of melted **T5** powder (image size 800x800 μ m) prepared by (a) conventional homogeneous catalytic method; (b) novel heterogeneously catalyzed protocol.

Enhanced properties can be expected for all the materials prepared in their use as Field-Effect Transistors (FET) and further investigations in this area are currently ongoing.

The optimized protocol was also employed in the preparation of thiophene based co-oligomers containing electron deficient 1,2,3-benzothiadiazole or electron-rich thienothiophene rings. Benzothiadiazole derivatives have been recently proved to have liquid crystal and semiconducting properties and the polymers have been reported as especially suitable materials for photovoltaic applications.²⁹ High air stability and charge carrier capabilities have been also recently reported for thienothiophene containing oligomers and polymers.⁴⁸ Thienothiophene-thienyl co-oligomers would potentially feature a combination of good π -stacking and charge transport properties (from the thienothiophene system) with the chemical versatility of the thienyl ring.

The benzothiadiazole-based compound (**31**) and the newly synthesized thienothiophene based products (**43** and **44**) were chosen as target compounds. The +2 approach (Figure 10) - both for odd oligomer (**31** and **43**) and for even oligomer (**44**) - was employed. Data are summarized in Table 8. The heterogeneously catalysed protocol provided the different synthesized compounds in moderate to very good isolated yields. Product **44** exhibited good solubility in non-polar solvents and highly crystalline cast films, therefore having promising perspectives as active layer in FETs.

Table 8. Catalytic performance of CHITCAT and SATCAT in the preparation of thiophene based co-oligomers

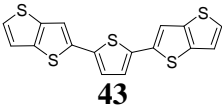
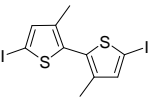
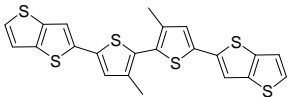
Entry	Starting material	Product	Catalyst	MW conditions	Yield ^a (%)
1	 30	 32	CHITCAT	100 W, 100 min., 130 °C	75
2 ^b	 30	 31	CHITCAT	100 W, 100 min., 130 °C	47
3	 41	 43	SATCAT	100 W, 100 min., 80 °C	81
4	 16b	 44	SATCAT	100 W, 100 min., 80 °C	65

^aIsolated yield. ^bLiterature data report 37% yield with a similar compound.⁴⁹ [‡]The starting material 4,4,5,5-tetramethyl-2-thieno[3,2-b]thiophen-2-yl-[1,3,2]dioxaborolane (**TTB**) was synthesized starting from thieno[3,2-b]thiophene following a standard procedure.^{7a}

5. Conclusions

In conclusion, this review shows how microwave acceleration and its combination with solid phase catalysis offers a new synthetic technology platform for the preparation of highly pure oligothiophenes. The methodologies presented here do not require a ‘one by one’ reaction/substrate optimization independently of the size and substitution of the thienyl starting substrates and enable the preparation of extremely pure materials in aqueous solvents and in few minutes. The high level of purity achieved upon simple filtration and washing procedures, avoids tedious and intensive-time consuming purification steps and the need to deal

with residual metals. Enhanced self-assembly capabilities and (opto)electronic properties in devices have been reported for materials obtained by using such new procedures.

References

1. Anastas, P. T.; Warner, J. C. *Green Chemistry, Theory and Practice*; Oxford University: New York, 1998.
2. *Handbook of Green Chemistry and Technology*; Clark, J. H.; Macquarrie, D. J., Eds.; Blackwell Science: Oxford, UK, 2002.
3. Murphy, A. R.; Fréchet, J. M. J. *Chem. Rev.* **2007**, *107*, 1066.
4. Mazzeo, M.; Vitale, V.; Della Sala, F.; Anni, M.; Barbarella, G.; Favaretto, L.; Sotgiu, G.; Cingolani R.; Gigli, G. *Adv. Mater.* **2005**, *17*, 34.
5. Günes, S.; Neugebauer, H.; Sariciftci, N. S. *Chem. Rev.* **2007**, *107*, 1324.
6. (a) Barrau, S.; Zhang, F.; Herland, A.; Mammo, M. R.; Anderson, R.; Inganäs, O. *Appl. Phys. Lett.* **2008**, *93*, 23307. (b) Nilsson, K. P. R.; Inganäs, O. *Nature Materials* **2003**, *2*, 419. (c) Capobianco, M. L.; Cazzato, A.; Alesi, S.; Barbarella, G. *Bioconjugate Chem.* **2007**, *18*, 318. (d) Leclère, Ph.; Surin, M.; Cavallini, M.; Biscarini, F.; Lazzaroni, R. *Mat. Sci. Eng. R.* **2006**, *55*, 1.
7. Kirschning, A.; Solodenko, W.; Mennecke, K. *Chem. Eur. J.* **2006**, *12*, 5972.
8. Mishra, A.; Ma C.-Q., Bäuerle, P. *Chem. Rev.* **2009**, *109*, 1141.
9. Barbarella, G.; Melucci, M.; Sotgiu, G. *Adv. Mater.* **2005**, *17*, 1581.
10. (a) Smits, E. C. P.; Mathijssen, S. G. J.; van Hal, P. A.; Setayesh, S.; Geuns, T. C. T.; Mutsaers, K. A. H. A.; Cantatore, E.; Wondergem, H. J.; Werzer, O.; Resel, R.; Kemerink, M.; Kirchmeyer, S.; Muzafarov, A. M.; Ponomarenko, S. A.; de Boer, B.; Blom, P. W. M.; de Leeuw, D. M. *Nature* **2008**, *455*, 956. (b) *Handbook of Thiophene-Based Materials, Applications in Organic Electronics and Photonics*; Perepichka, I. F.; Perepichka, D. F., Eds.; John Wiley & Sons, 2009; Chapter 4. (c) *Organic Electronics and Optoelectronics, Chem. Rev.* **2007**, *104*, special issue.
11. Gedye, R.; Smith, F.; Westaway, K.; Ali, H.; Baldisera, L. *Tetrahedron Lett.* **1986**, *27*, 279.
12. Babudri, F.; Farinosa, G. M.; Naso, F. *J. Mater. Chem.* **2004**, *14*, 11.
13. Stille, J. K. *Angew. Chem., Int. Ed. Engl.* **1986**, *25*, 508.
14. (a) Suzuki, A. *J. Organomet. Chem.* **2002**, *653*, 83. (b) Suzuki, A. *J. Organomet. Chem.* **1999**, *576*, 147. (c) Miyaura, N.; Suzuki, A. *Chem. Rev.* **1995**, *95*, 2457.
15. (a) Grasa, G. A.; Viciu, M. S.; Huang, J. C.; Zhang, M. L.; Trudell, S. P.; Nolan, A. *Organometallics* **2002**, *21*, 2866. (b) Benbow, J. W.; Martinez, B. L. *Tetrahedron Lett.* **1996**, *37*, 8829. (c) Mathews, C. J.; Smith, P. J.; Welton, T. *Chem. Commun.* **2000**, 1249. (d) Pei, J.; Ni, J.; Zhou, X. H.; Cao, X. Y.; Lai, Y. H. *J. Org. Chem.* **2002**, *67*, 4924.
16. Arvela, R. K.; Leadbeater, N. E.; Sangi, M. S.; Williams, V. A.; Granados, P.; Singer, R. D. *J. Org. Chem.* **2005**, *70*, 161.
17. (a) Larhed, M.; Moberg, C. A.; Hallberg, A. *Acc. Chem. Res.* **2002**, *35*, 717. (b) Olofsson, K.; Larhed, M. In *Microwave Assisted Organic Synthesis*; Lidström, P.; Tierney, J. P., Eds.; Blackwell: Oxford, 2004; Chapter 2.
18. Melucci, M.; Barbarella, G.; Sotgiu, G. *J. Org. Chem.* **2002**, *67*, 8877.
19. (a) Villemin, D.; Caillot, F. *Tetrahedron Lett.* **2001**, *42*, 639. (b) Kabalka, G. W.; Pagni, R. M.; Hair, C. M. *Org. Lett.* **1999**, *1*, 1423.
20. (a) Van Pham, C.; Burkhardt, A.; Shabana, R.; Cunningham, D. D.; Mark, H. B., Jr.; Zimmer, H. *Phosphorus, Sulfur and Silicon* **1989**, *46*, 153. (b) Merz, A.; Ellinger, F. *Synthesis* **1991**, 462. (c) Kagan, J.; Arora, S. K. *J. Org. Chem.* **1983**, *48*, 4317. (d) Tasaka, S.; Katz, H. E.; Hutton, R. S.; Orenstein, J.; Fredrikson, G. H.; Wang, T. T. *Synthetic Metals* **1986**, *16*, 17.
21. (a) Ishiyama, T.; Itoh, Y.; Kitano, T.; Miyaura, N. *Tetrahedron Lett.* **1997**, *38*, 3447. (b) Giroux, A.; Han, Y.; Prasit, P. *Tetrahedron Lett.* **1997**, *38*, 3841.
22. Hassan, J.; Lavenot, L.; Gozzi, C.; Lemaire, M. *Tetrahedron Lett.* **1999**, *40*, 857.
23. Melucci, M.; Gazzano, M.; Barbarella, G.; Cavallini, M.; Biscarini, F.; Maccagnani, P.; Ostojia, P. *J. Am. Chem. Soc.* **2003**, *125*, 10266.

24. Barabási, A. L.; Stanley, H. E. *Fractal Concepts in Surface Growth*; Cambridge University Press: Cambridge, UK, 1996.
25. (a) Biscarini, F.; Zamboni, R.; Samori, P.; Ostoja, P.; Taliani, C. *Phys. Rev. B* **1995**, *52*, 14868. (b) Biscarini, F.; Samori, P.; Greco, O.; Zamboni, R. *Phys. Rev. Lett.* **1997**, *78*, 2389. (c) Viville, P.; Lazzaroni, R.; Brédas, J. L.; Moretti, P.; Samori, P.; Biscarini, F. *Adv. Mater.* **1998**, *10*, 57.
26. Tsamouras, D.; Palasantzas, G. *Appl. Phys. Lett.* **2002**, *80*, 4528.
27. Barbarella, G.; Zambianchi, M.; Antolini, L.; Ostoja, P.; Maccagnani, P.; Bongini, A.; Marseglia, E.; Tedesco, E.; Gigli, G.; Cingolati, R. *J. Am. Chem. Soc.* **1999**, *121*, 8920.
28. Sotgiu, G.; Zambianchi, M.; Barbarella, G.; Botta, C. *Tetrahedron* **2002**, *58*, 2245.
29. Melucci, M.; Barbarella, G.; Zambianchi, M.; Di Pietro, P.; Bongini, A. *J. Org. Chem.* **2004**, *69*, 4821.
30. Melucci, M.; Favaretto, L.; Bettini, C.; Gazzano, M.; Camaioni, N.; Maccagnani, P.; Ostoja, P.; Monari, M.; Barbarella, G. *Chem. Eur. J.* **2007**, *13*, 10046.
31. Maunoury, J. C.; Howse, J. R.; Turner, M. L. *Adv. Mater.* **2007**, *19*, 805.
32. Lampert, M. A.; Mark, P. *Current Injection in Solids*; Academic Press: New York, 1970.
33. Trap-free space-charge limited current is given by $j=9/8 \epsilon_0 \epsilon_r \mu V^2 L^{-3}$, where ϵ_0 is the vacuum permittivity, ϵ_r is the relative dielectric constant of the material, μ is the charge carrier mobility and L is the distance between the electrodes (20 μm in the present case). Though the trap-free limit is not experimentally accessible, the above formula can be used to extract a lower limit for the material intrinsic mobility (by using $\epsilon_r=3$), at least in the case in which one type of carriers (holes in this case) is responsible for charge transport.
34. Yin, L.; Liebscher, J. *Chem. Rev.* **2007**, *107*, 133.
35. Marck, G.; Villiger, A.; Buchecker, R. *Tetrahedron Lett.* **1994**, *35*, 3277.
36. Felpin, F-X.; Ayad, T.; Mitra, S. *Eur. J. Org. Chem.* **2006**, 2679.
37. Dioos, B. M. L.; Vankelecom, I. F. J.; Jacobs, P. A. *Adv. Synth. Catal.* **2006**, *348*, 1413.
38. Macquarrie, D. J.; Hardy, J. J. E. *Ind. Eng. Chem. Res.* **2005**, *44*, 8499.
39. Gronnow, M. J.; Luque, R.; Macquarrie, D. J.; Clark, J. H. *Green Chem.* **2005**, *7*, 552.
40. Mubofu, E. B.; Clark, J. H.; Macquarrie, D. J. *Green Chem.* **2001**, *3*, 23.
41. Paul, S.; Clark, J. H. *Green Chem.* **2003**, *5*, 635.
42. Hardy, J. J. E.; Hubert, S.; Macquarrie, D. J.; Wilson, A. J. *Green Chem.* **2004**, *6*, 53.
43. Alesi, S.; Di Maria, F.; Melucci, M.; Macquarrie, D. J.; Luque, R.; Barbarella, G. *Green Chem.* **2008**, *10*, 517.
44. Lempers, H. E. B.; Sheldon, R. A. *J. Catal.* **1998**, *175*, 62.
45. Katz, H. E.; Laquindanum, J. G.; Lovinger, A. *Chem. Mater.* **1998**, *10*, 633.
46. Dimitrakopoulos, C. D.; Malenfant, P. R. L. *Adv. Mater.* **2002**, *14*, 99.
47. Amundson, K. R.; Katz, H. E.; Lovinger, A. J. *Thin Solid Films* **2003**, *426*, 140.
48. (a) Kim, H-S.; Kim, Y-H.; Kim, T-H.; Noh, Y-Y.; Pyo, S.; Yi, M. H.; Kim, D-Y.; Kwon, S-K. *Chem. Mater.* **2007**, *19*, 3561. (b) Medina, M.; Van Vooren, A.; Brocorens, P.; Gierschner, J.; Shkunov, M.; Heeney, M.; McCulloch, I.; Lazzaroni, R.; Cornil, J. *Chem. Mater.* **2007**, *19*, 4949.
49. Bundgaard, E.; Krebs, F. C. *Macromolecules* **2006**, *39*, 2823.